

INSTALLATION

Name of the parts

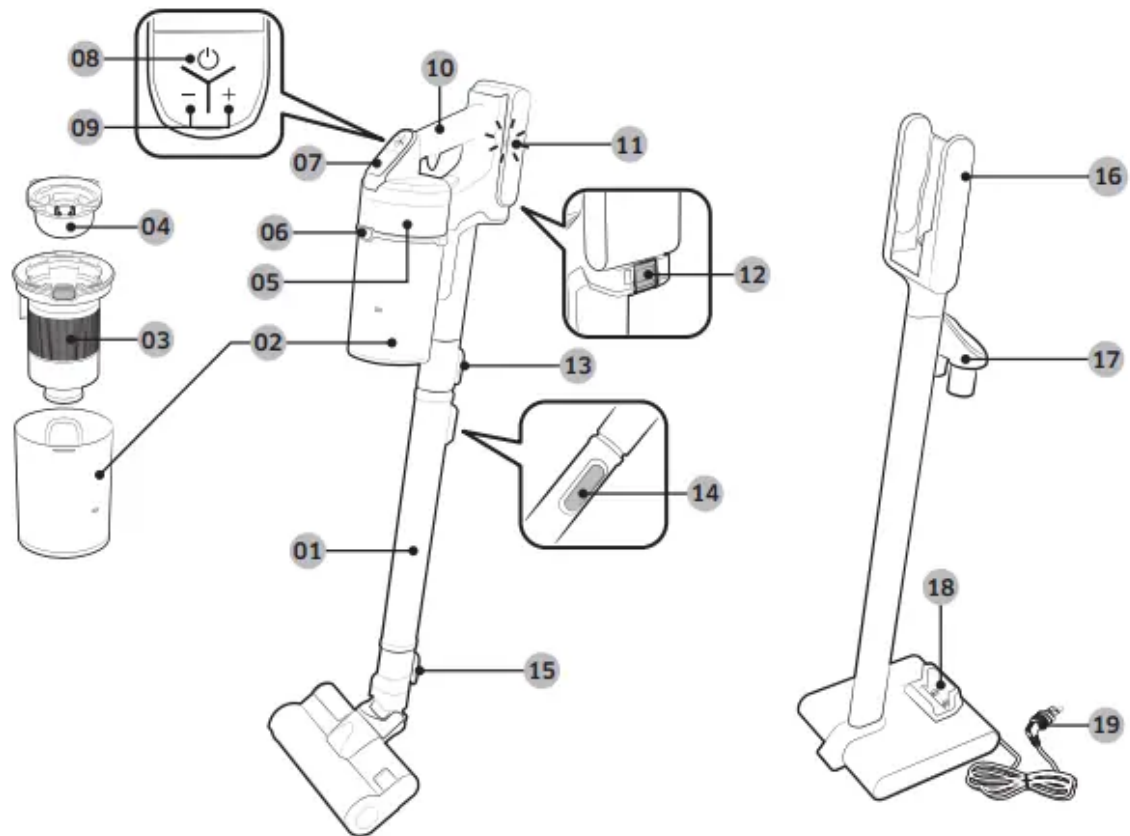

01 Pipe (Adjustable)

02 Dustbin

03 Metal mesh grille filter

04 Washable micro filter

05 Ultra fine dust filter

06 Dustbin release button

07 Display

08 Power(⏻) button

09 Suction power control button

10 Handle

11 Battery level indicator

12 Battery release button

13 Pipe release button

14 Pipe length adjustment button

15 Brush release button

16 Vacuum charging part

17 Accessory holder

18 Additional battery charging slot

19 Power cord

* Battery Spec

VS20R90**** Series : Lithium-ion 21.9 V, 2850 mAh, 6 cell

VS15R85**** Series : Lithium-ion 21.6 V, 1800 mAh, 6 cell

* Those two batteries are not compatible with each other.

Accessories

Accessories may differ depending on the models.



Pipe (Adjustable)



Soft Action Brush



Turbo Action Brush



Mini Motorized Tool



Combination Tool



Extension Crevice Tool



Flexible Tool



Wet Brush /
Multi-use wet pad

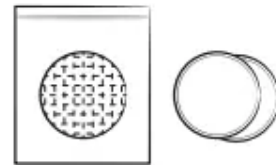

Single-use wet pad /
Attachable pad

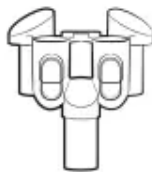

Brush holder



Battery



User manual



Screws: 2 EA /
Screw anchors: 2 EA /
Fixing hook: 1 EA

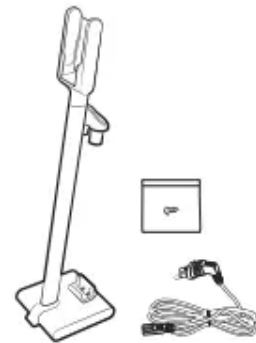

Charging stand /
Screw: 1 EA / Power cord

Installing the charging stand

Installation guide

Assembling the charging stand

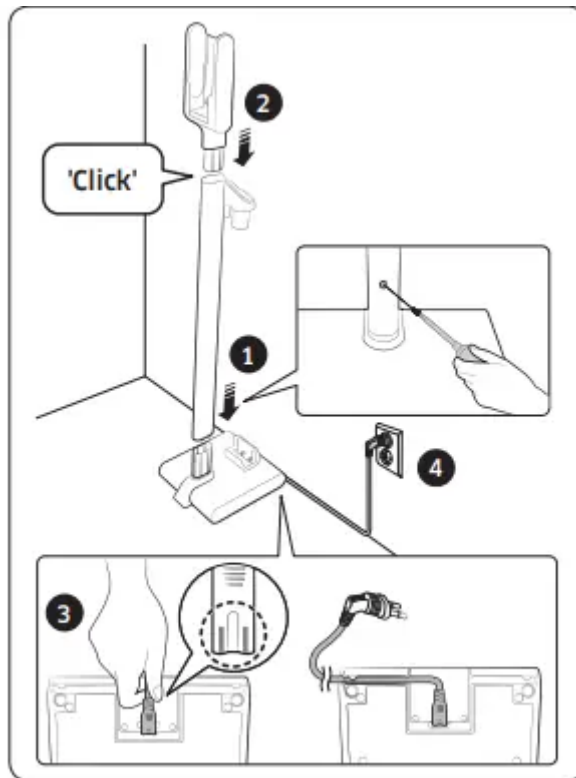

1. Assemble the stand pipe to the bottom support, and fix it with a screw (small).
 - Make sure the direction for the assembly is correct and push it in firmly so that the screw hole is made correctly.
2. Assemble the vacuum charging part to the top of the stand pipe.
 - Do not disassemble it after the assembly.
3. Connect the power cord to the rear of the charging stand.
 - Hold the connection part of the cord and push it onto the connection pins firmly until the gray lines on the tip of the cord are not visible.
 - When inserting the cord into the groove on the bottom of the bottom support, charging stand can be installed close against the wall.
4. Plug in the charging stand

Fixing by the hook

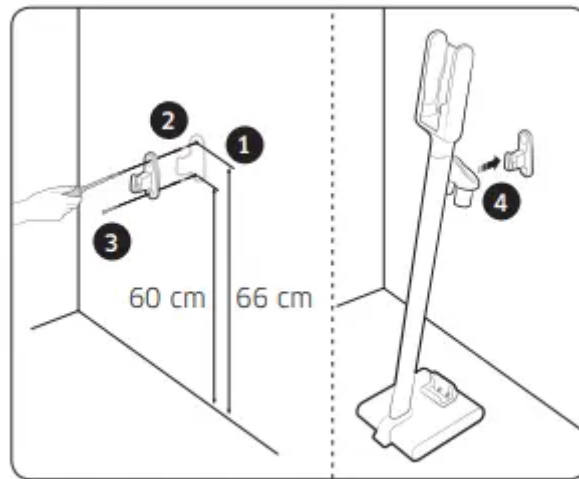

1. Using the fixing hook as a template, mark where the top and bottom screw holes will be placed on the wall.
 - Top: 66 cm from the floor
 - Bottom: 60 cm from the floor
2. Drill the holes using a 6 mm drill bit, and put the provided screw anchors into the hole.
3. Fix the fixing hook to the wall with the provided screws (large).
4. Hook the groove of the charging stand into the fixing hook.

OPERATION

Using the vacuum cleaner

Using the charging stand

Charging

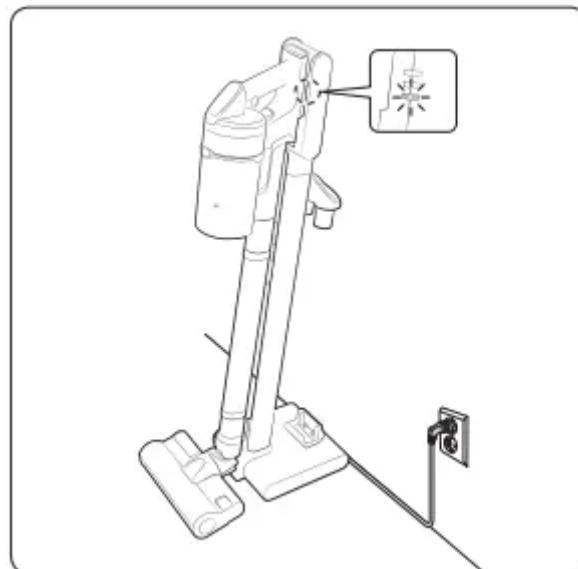

- Make sure the back of the battery is correctly placed onto the vacuum charging part.

- Check if the battery level indicator is displayed while charging.
- The battery level indicator blinks while charging. When charging is complete, the blinking stops and the light level dims.

Storing the accessories

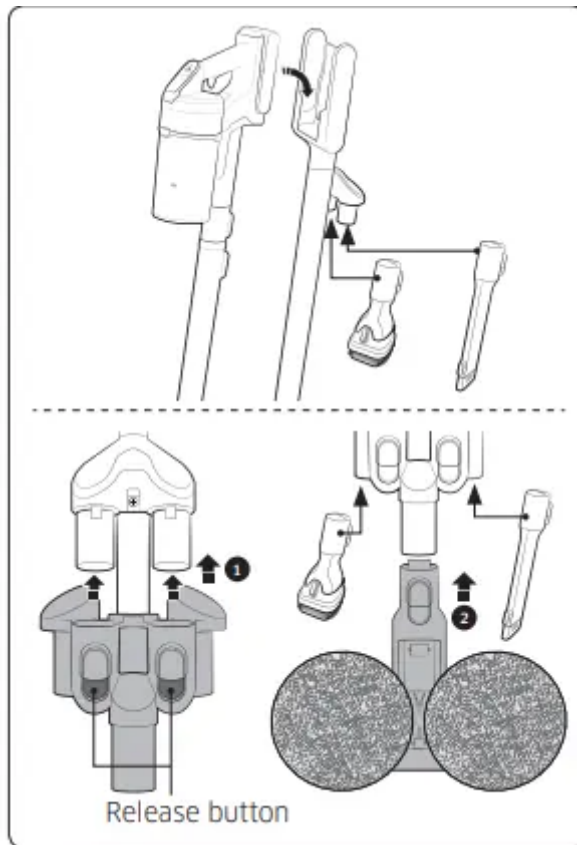

- When accessories are disassembled to be stored, dust may fall from the suction part of the vacuum cleaner.
- After cleaning, shorten the pipe length and operate in MAX mode for 10 seconds.

Storing the wet brush: When the brush holder is assembled to the charging stand, wet brush can also be stored at the charging stand.

- Do not assemble the mini motorized tool to the brush holder. Otherwise, the product can be damaged.
- If the pad is wet and stored at the wet brush, the wall near the wet pad can be contaminated. After cleaning the pad, dry the pad completely.
- When disassembling the brush holder, press the 2 release buttons on the holder.

Charging the battery

- When the battery level indicator is at its lowest level and blinks () charge the battery.

- When charging the vacuum, make sure the connection part of the charging stand is correctly connected.
- The vacuum cleaner cannot be used while it is charging.

CAUTION

- Before ejecting the battery, the product must be turned off. (If the battery is forcibly ejected while the vacuum is operating, the vacuum can malfunction.)
- Be careful not to drop the battery. If you do, you can injure yourself or damage the battery.

Ejecting the battery

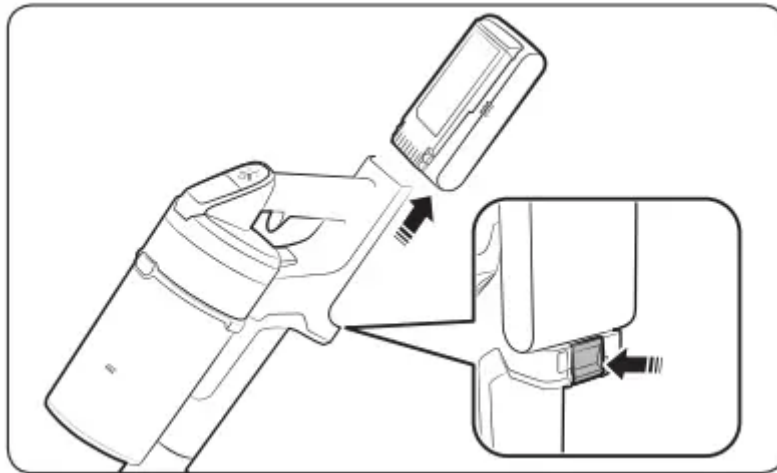

- Press the battery release button at the rear of the handle to eject the battery

Re-inserting the battery

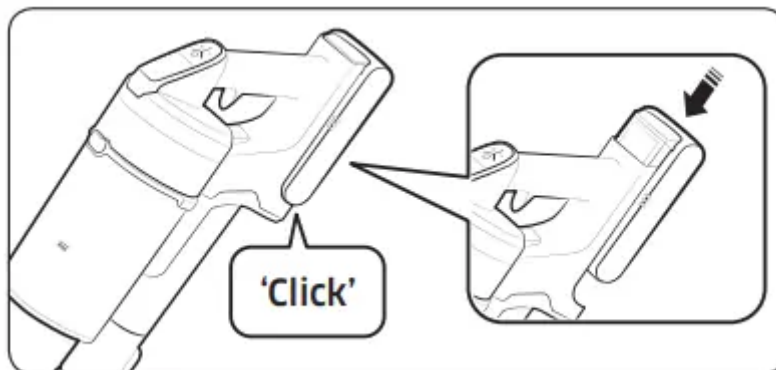

- Push the battery to the end until you hear it click.

Charging the additional battery

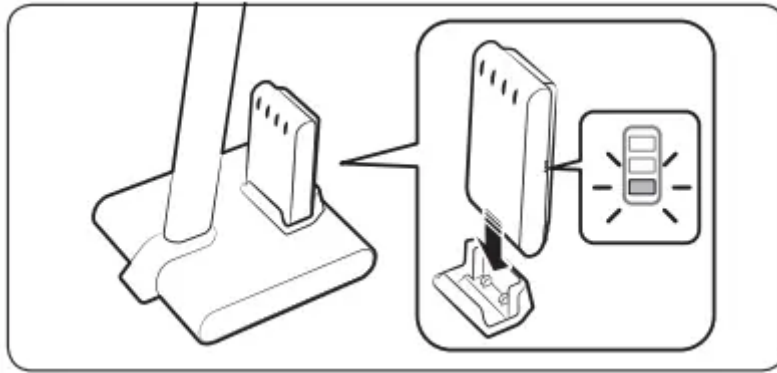

- Charge the additional battery at the additional battery charging slot at the bottom of the charging stand.
- Push the battery in firmly.
- Check if the battery level indicator is displayed while charging.

Operating the vacuum cleaner

When the brush clings to the floors such as a carpet, a mat, bedding, etc. or does not spin properly, change the suction power to 'MIN' or 'MID' mode.

Power (,) on / off

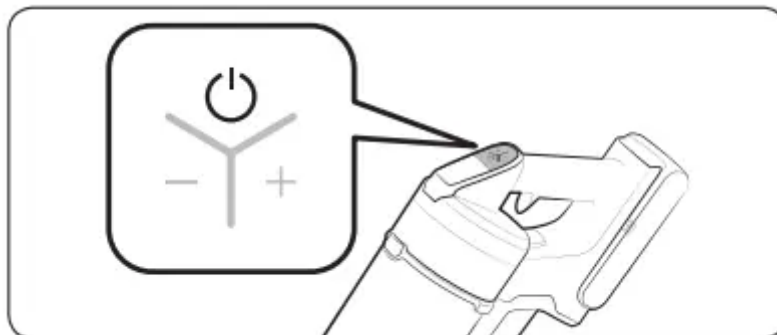

- When pressing the power button, the vacuum cleaner starts operation in 'MID' mode.
- When the wet brush is assembled, operation starts in 'WET' mode.

Controlling suction power

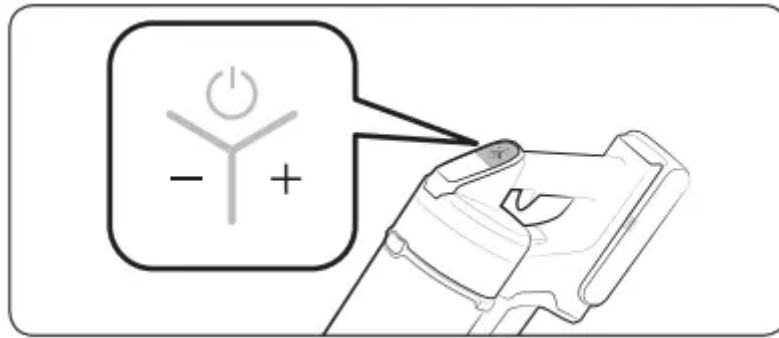

- You can control the suction power of the vacuum cleaner.
 - + button: Increases suction power.
 - - button: Decreases suction power.
- The suction power control button does not work in WET mode

Checking the display

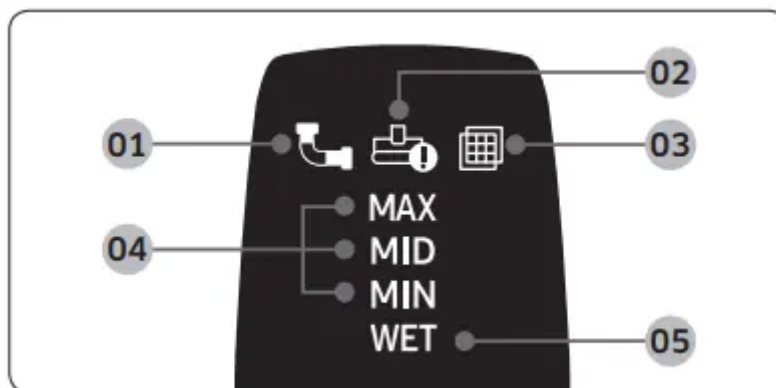

- 01 Clogged: When the dustbin, pipe, or suction part is clogged
- 02 Spinning brush stuck: When a foreign matter is clogged at the spinning brush
 - If the overheating prevention device of the motor works, the spinning brush stuck display will not turn on.
- 03 No Filter: When the washable micro filter is not assembled correctly
- 04 Suction power: Displays current suction power.
- 05 Wet brush cleaning mode: When the wet brush is assembled
 - If the display above 01, 02, or 03 blinks a few times and the vacuum cleaner stops operation, please take action by referring to the maintenance part of this manual.

Using the accessories

If the vacuum operates with the spinning brush not working, check whether the brush gets excessive force or clogged with a foreign matter. (Please refer to the troubleshooting part of this manual.)

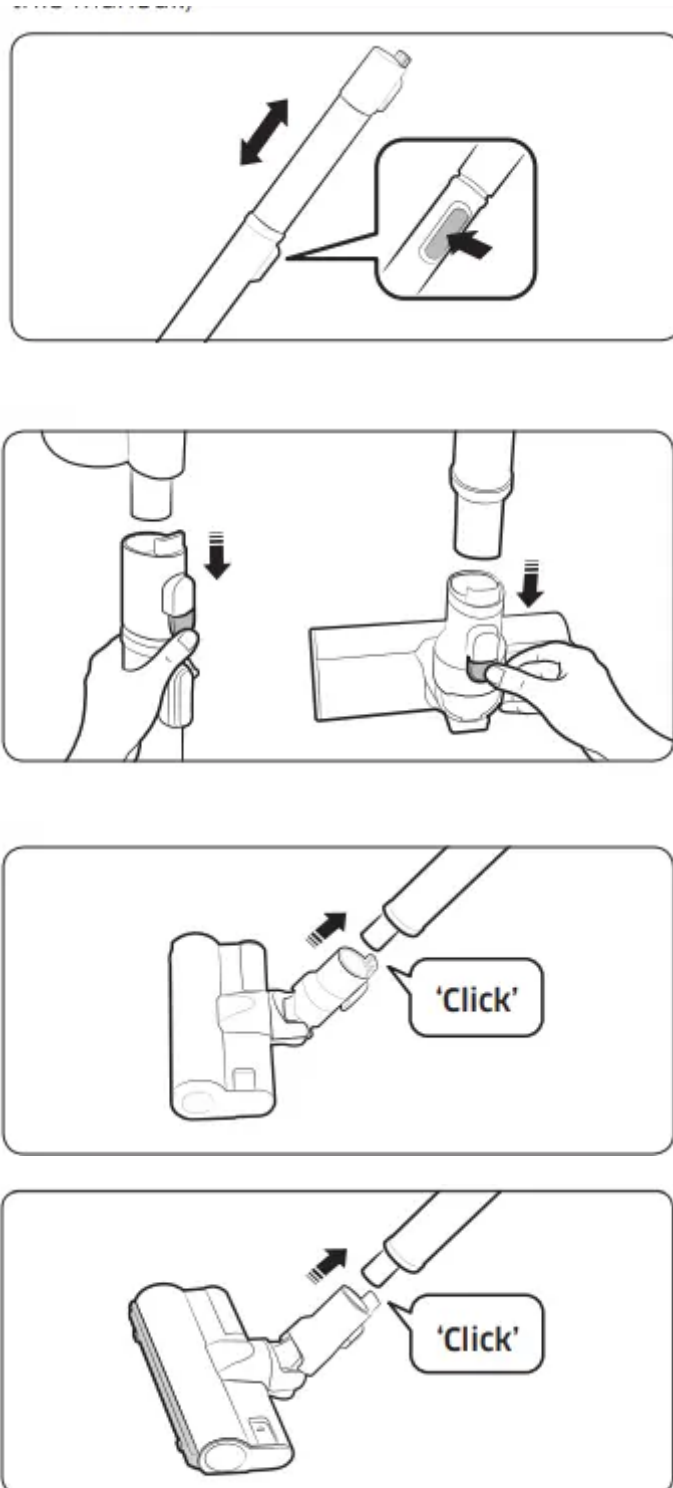

Adjusting the pipe length

- Press the button at the rear of the pipe to adjust the length of the pipe in 4 steps.

Disassembling the accessories

- When disassembling the pipe, press the release button at the rear of the pipe.
- Before disassembling the accessories, operate in MAX mode for more than 10 seconds to remove foreign matter remained in the accessories.
- When disassembling the brush, press the release button at the rear of the brush.

Soft Action Brush: Use to clean a floor (wood and linoleum).

- It is best for hard floor types.

Turbo Action Brush

- Use the Turbo Action Brush to clean various floor conditions at home, it is also suitable to clean carpet.

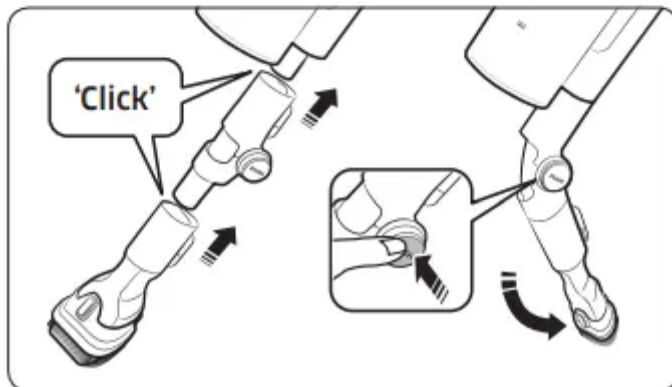
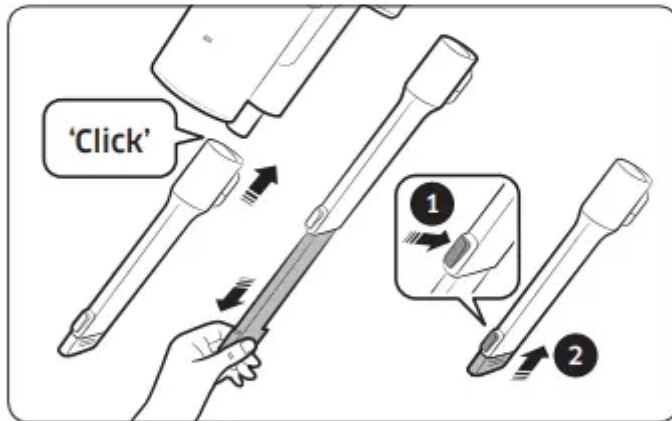
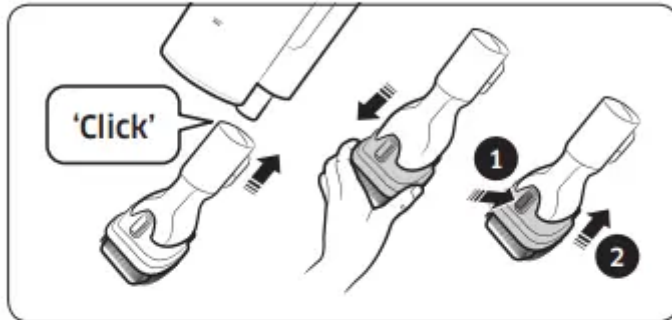
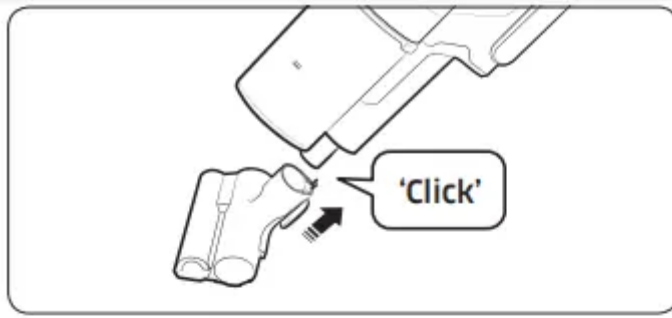

Mini Motorized Tool

- Use to clean bedding or sofas

Combination Tool

- Use to remove dust from curtains, furniture, sofas, keyboards, etc.



Extension Crevice Tool

- Use to remove dust in grooves of window frames, crevices, corners, etc.

Flexible Tool

- Use to clean the places hard to reach such as upper or rear parts of furniture or ceilings.
- NOTE: The Flexible Tool can be connected to the Combination Tool and Extension Crevice Tool.

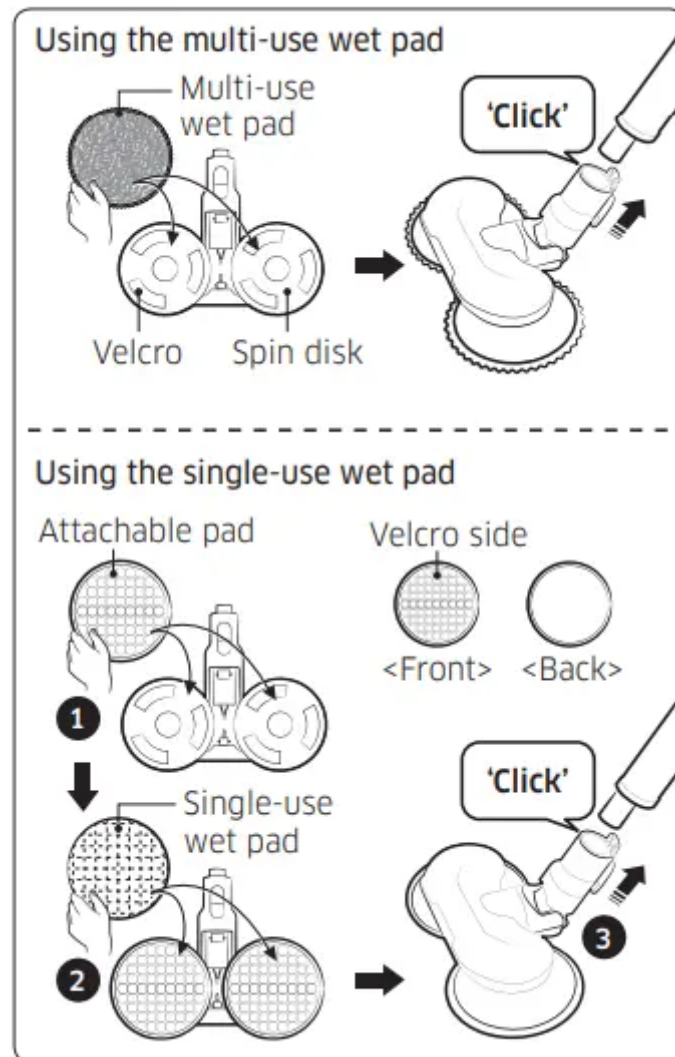

Wet Brush: Use to clean a floor with a wet pad (wood and linoleum).

- The Wet Brush does not have a dust suction function.
- When attaching the wet pad, make sure the pad is in the center of the spin disk.
- After using the wet brush, store it at the brush holder.

Using the multi-use wet pad: Attach the multi-use wet pad to the spin disk.

Using the single-use wet pad" Attach the attachable pad to the spin disk and attach the single-use wet pad on top of it .

- When using the single-use wet pad, make sure the direction of the attachable pad is correct. Velcro side is the front side.
- After using the single-use wet pad, discard the pad.
- If you use the single-use wet pad without the attachable pad, cleaning performance can be degraded.

MAINTENANCE

Maintaining the vacuum cleaner

CAUTION

- Before cleaning the vacuum cleaner, turn it off.
- When the dustbin or filter is filled with dust, the vacuum cleaner may stop due to the overheating prevention device of the motor.
- You should clean the dustbin or filter before it becomes completely full (Max sign)

When to empty the dustbin

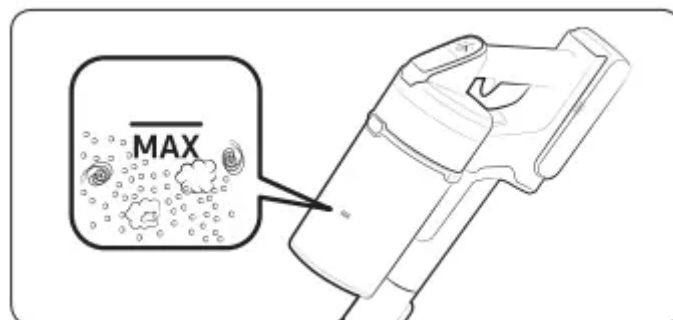

Emptying the dustbin easily without causing dust clouds

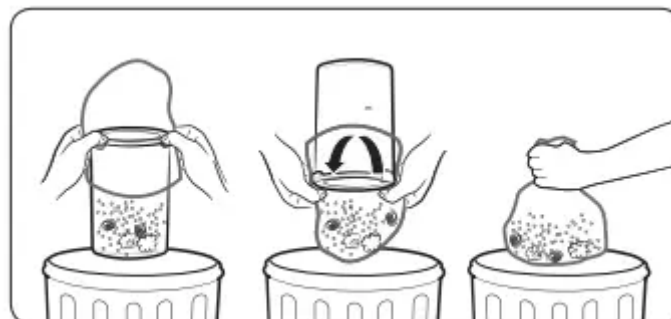

Emptying and cleaning the dustbin

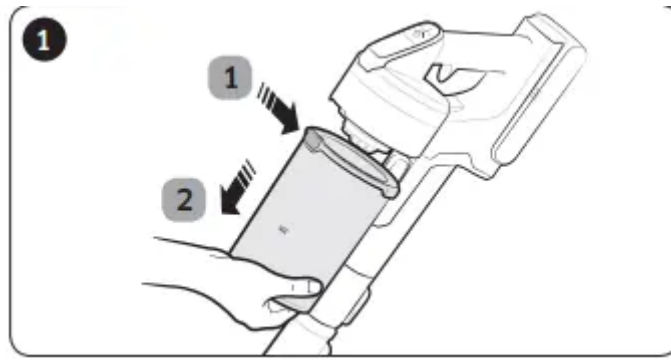

1. After pressing the dustbin release button,
2. pull the dustbin in the direction of the arrow.

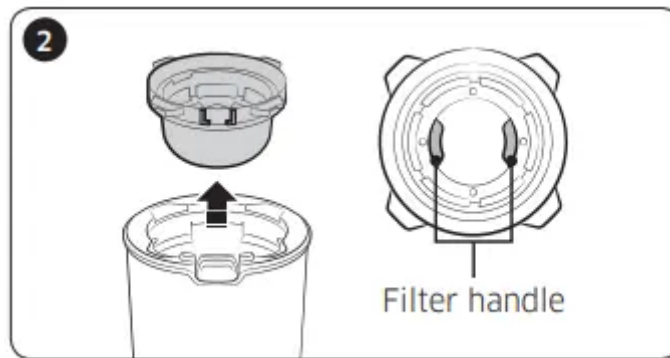

- Pull the washable micro filter out by holding the filter handles inside the washable micro filter.

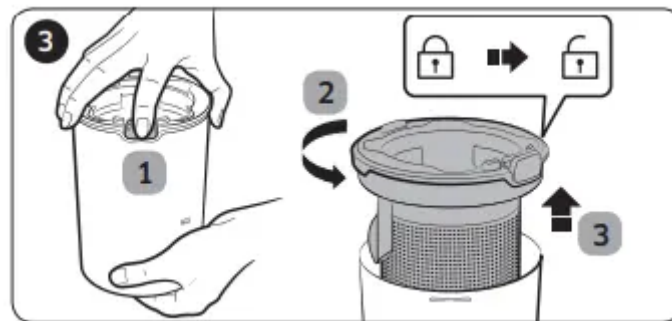

- 1 While pressing the button, 2 turn the dustbin cover and 3 remove it from the dustbin.

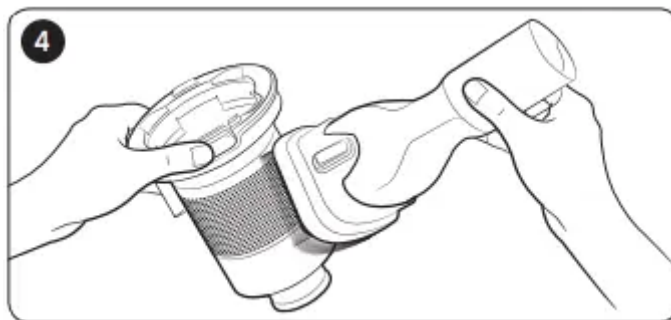

- Remove the dust on the metal mesh grille filter with the combination tool.
 - Do not pull the rubber attached to the metal mesh grille filter.

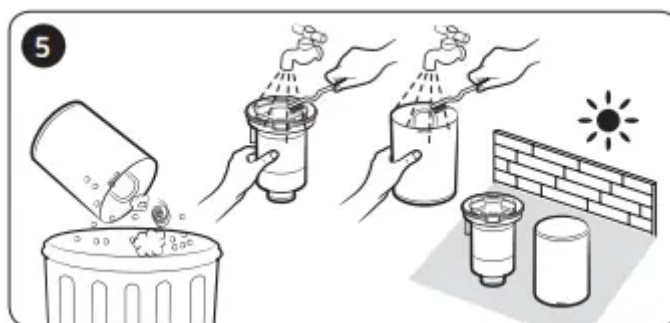

- After emptying the dustbin, clean it and dry in the shade.

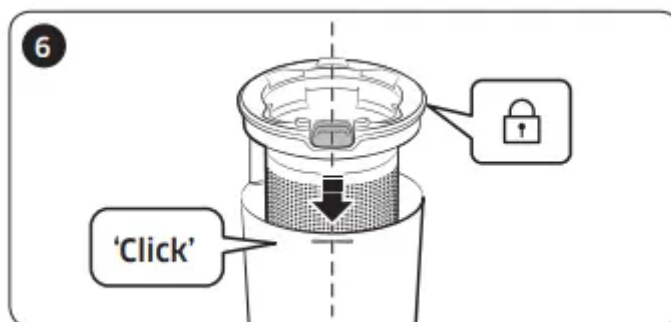

- Reassemble the dustbin cover aligning the dustbin release button with the groove of dustbin.

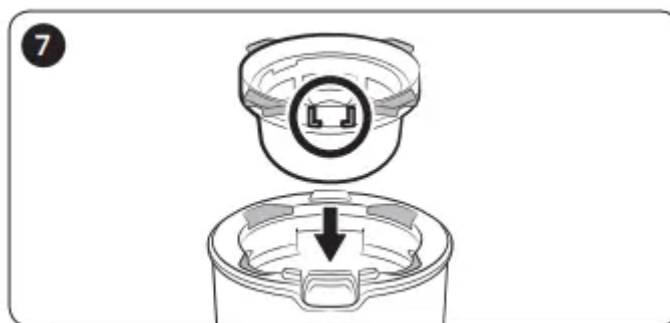

- Put the washable micro filter in the dustbin cover by fitting in the groove on the filter first as shown in the picture.

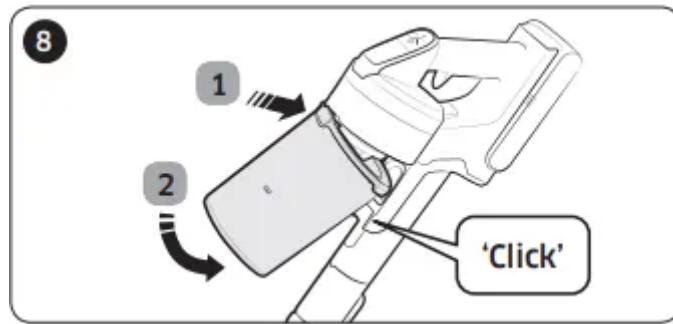

- Assemble the dustbin to the vacuum in the order shown in the image by pushing it until you hear it click.

Cleaning the filter

- To maintain the best performance of the filter, remove the dust on the filter frequently and clean the filter with water once a month.
 - After cleaning, dry completely for more than 24 hours in the shade before use.

Washable micro filter

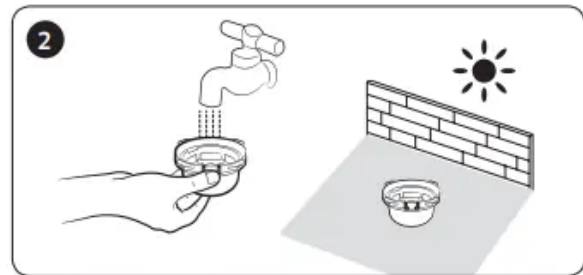

Ultra fine dust filter

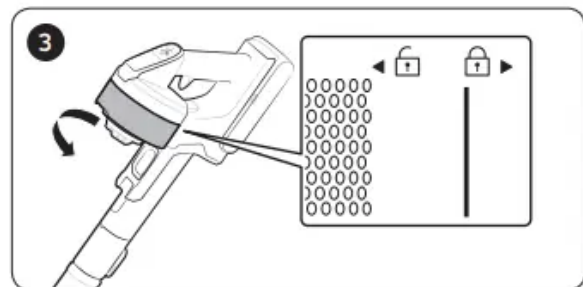
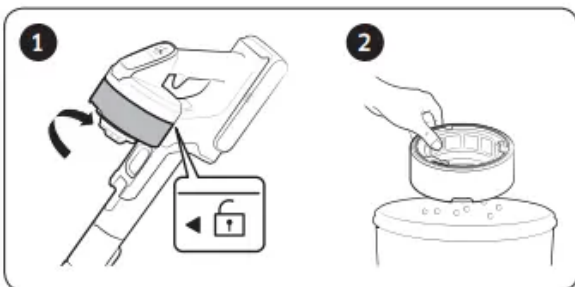

* When assembling, turn the filter until the line below the lock image is not visible.

Cleaning the accessories

- Mini Motorized Tool

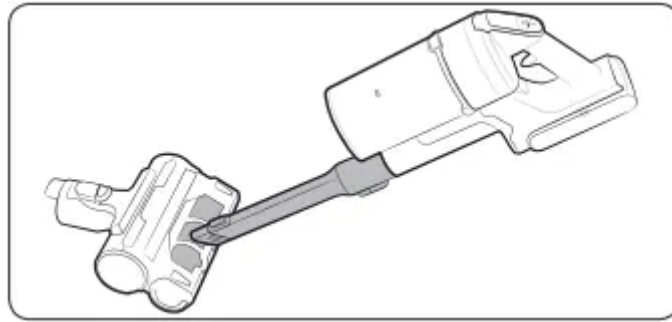

- Extension Crevice Tool / Adjustable pipe

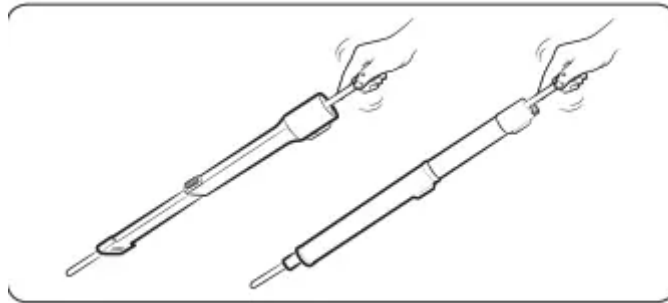

Soft Action Brush

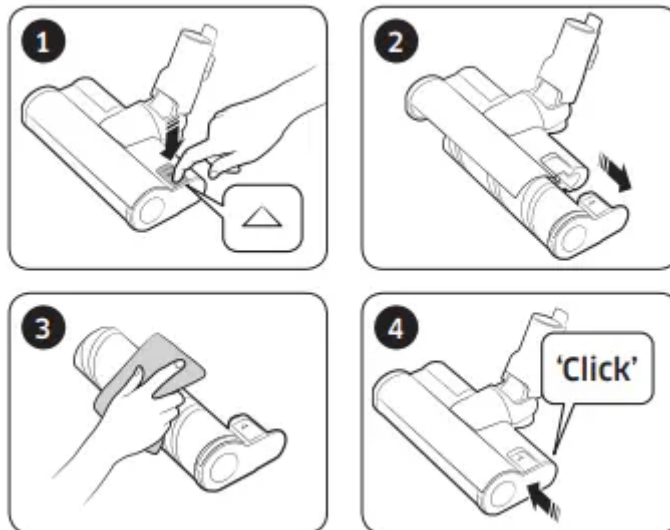

NOTE

- When foreign matter remains on the brush, remove it with a wet tissue or a dry cloth.

CAUTION

- Do not clean the spinning brush and suction part with water.
- Do not use the Soft Action Brush to remove moisture such as split liquid and pet's waste.

Turbo Action Brush

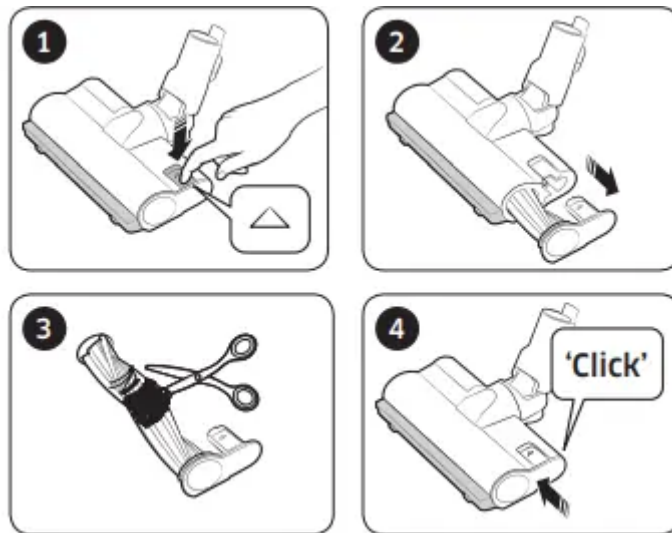

- If the foreign matter is not removed, use a scissors to remove it.

NOTE

- If a cloth or other foreign matter is vacuumed up and tangled with the spinning brush (drum), the spinning brush will stop working to protect the brush motor. After cleaning the brush, turn the power off and then on again.
- If a brush does not work after cleaning, turn the power off and then on again.
- When cleaning the brush, be careful not to catch your fingers in the fold of the brush.

Wet Brush

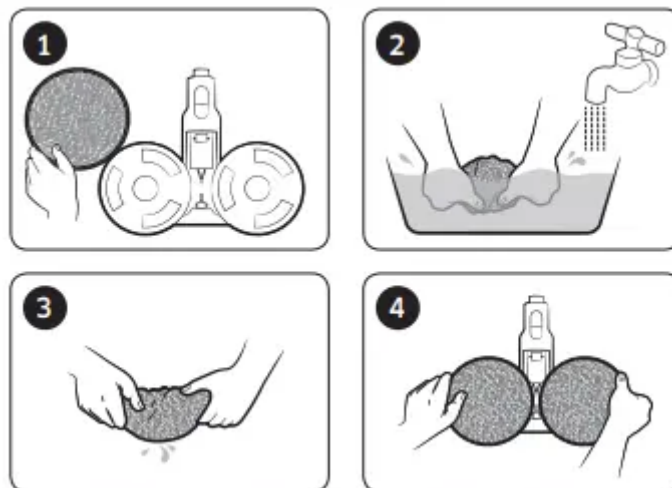

NOTE

- If the spinning brush does not work even after cleaning the Soft Action Brush, Turbo Action Brush and Wet Brush, the overheating prevention device of the brush motor might be in operation. Wait 30 minutes or more to cool the motor and operate again.

Troubleshooting

Before calling for service, review the problems and solutions below. If none of the suggested solutions resolve your problem, please visit our website at www.samsung.com or call Samsung Customer Care. Note that you will be charged for any service calls in which no defects were found.

1. The vacuum cleaner does not work.

- Check the battery level and charge the battery.
- Check whether the product is turned off, and then press the power button to turn it on.
- Check whether the pipe, dustbin or brush is blocked.
- Check whether the washable micro filter is inserted correctly.
- If the vacuum has not been used for a long time, charge the battery.
- If the battery dies, replace the battery.

2. Suction force decreases suddenly and the vacuum makes a vibrating sound.

- Check whether a brush, dustbin or pipe is clogged with foreign matter and remove it.
- Check whether the pipe, dustbin is fully filled with dust. If it is, empty the bin.
- Check whether the filter is dirty. If it is, clean the filter.

3. The vacuum cleaner cannot be charged.

- Confirm that the voltage provided to the charging stand matches the requirements of the charging stand.
- Check if the vacuum cleaner is turned on, and then check if the LED of the battery level indicator is turned on.
- Check if foreign matter (dust) is on the charging terminal. Remove any foreign matter with a cotton swab or soft cloth.

4. The spinning brush (drum) inside a brush does not work.

- When the spinning brush stuck display is turned on, turn off the vacuum and check whether the brush is clogged with foreign matter. If so, remove the foreign matter and restart the vacuum.
- Check if the vacuum cleaner is turned on and then turn it off and on again.
 - For the Soft Action Brush, Turbo Action Brush and Wet brush, if the overheating prevention device of the brush motor operates, it may take about 30 minutes to cool the motor.

5. An odor is coming from the air outlet or filter of the vacuum cleaner.

- Empty the dustbin and clean the filters frequently.
 - As your vacuum cleaner is a new product, it may have a slight odor for the first 3 months after purchase.
 - If you use the vacuum cleaner frequently, accumulated dirt in the dustbin or dust on the filter may generate an odor.
- Replacement filters are available at your local Samsung service agent.

6. Cleaning is finished but small dust particles come out of the brush.

- After cleaning, operate the vacuum for 10 seconds or more to suction up the small dust particles.

7. Vacuum cleaner stops operation during cleaning.

- As this product has the overheating prevention device of the brush motor, product will stop operation temporarily for the following conditions.
 - When the vacuum operates with a full dustbin.
 - When the vacuum operates with suction part or brush clogged.
 - When the Extension Crevice Tool is used for long hours.
- Check these problems then turn the vacuum on after a while. (This case may differ depending on the ambient temperature.)

8. Static electricity occurs when cleaning a thick and soft mat.

- Materials of a mat (childcare center mat, noise prevention mat for between floors, etc.) may cause the static electricity.
 - Move the brush on a normal floor for a while and clean again, then the static electricity should disappear.

Warning

This content is compiled from multiple sources and is provided for reference purposes only. It may not be complete or fully applicable to all situations. If you are unable to resolve your issue, please contact the product manufacturer or an authorized service provider for official support.