

PRODUCT OVERVIEW

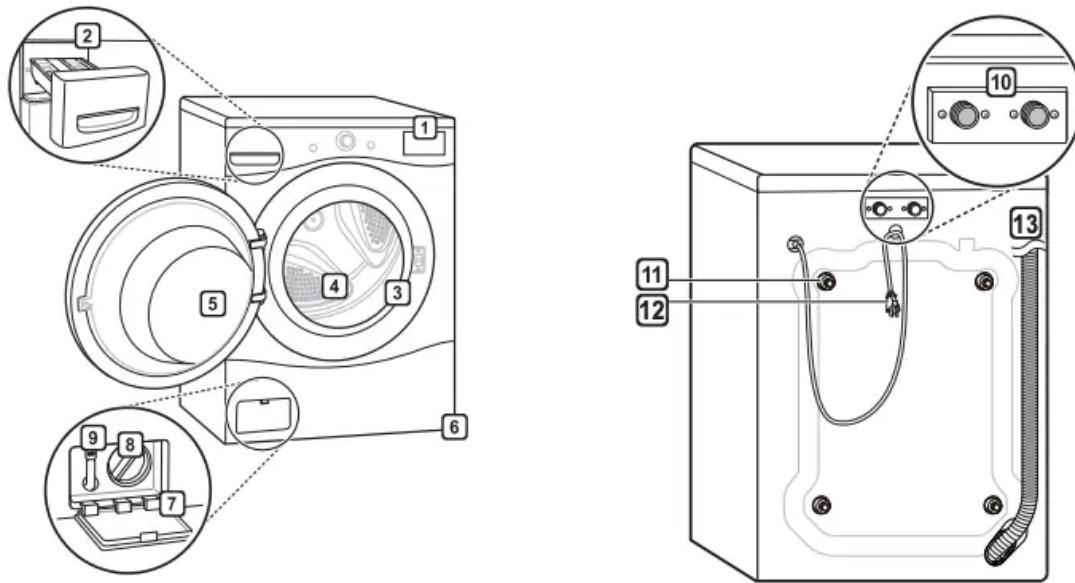

- 1** Control Panel
- 2** Detergent Dispenser Drawer
- 3** Door Seal
- 4** Drum
- 5** Door
- 6** Leveling Feet
- 7** Drain Pump Filter Cover
- 8** Drain Pump Filter
- 9** Drain Hose
- 10** Water Inlets
- 11** Shipping Bolts
- 12** Power Cord

OPERATION

Using the Washer

 **WARNING**

- To reduce the risk of fire, electric shock, or injury to persons, read the SAFETY INSTRUCTIONS before operating this appliance.

1 Sort Laundry and Load the Washer

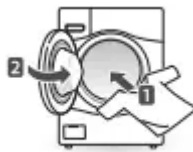

Sort laundry by fabric type, soil level, color and load size, as needed. Open the door and load items into the washer. If using detergent pods, place pod in drum before loading laundry.

2 Add Cleaning Products.



Add the proper amount of HE (High-Efficiency) detergent to the detergent dispenser. If desired, add bleach or fabric softener to the appropriate areas of the dispenser drawer. Do not place liquid or powdered detergent pods in the dispenser.

3 Turn on the Washer



Press the Power button to turn on the washer. The lights above the cycle buttons will illuminate and a chime will sound.

4 Select a Cycle



Turn the Cycle Selector Knob until the desired cycle is selected. The preset Temp., Spin, Soil and option settings for that cycle will be shown. Pressing the Start/Pause button without selecting a cycle will cause the Normal cycle to begin immediately.

5 Adjust Settings



Default settings for the selected cycle can now be changed, if desired, using the cycle modifier and option buttons.

- Not all modifiers and options are available on all cycles. A different chime will sound and the LED will not come on if the selection is not allowed.

6 Begin Cycle



Press the Start/Pause button to begin the cycle. The washer will agitate briefly without water to measure the weight of the load. If the Start/Pause button is not pressed within 60 minutes, the washer will shut off and all settings will be lost.

7 End of Cycle



When the cycle is finished, a melody will sound. Immediately remove your clothing from the washer to reduce wrinkling. Check around the door seal when removing the load for small items that may be caught in the seal.

NOTE

- The washer rotates the laundry in a way that allows it to use less water while still fully saturating your clothing. It is normal to not be able to see water during the wash cycle.
- If the temperature or the water level inside the machine is too high, the door will not unlock when the Start/ Pause button is pressed. To open the door in these circumstances, press Add Garments. To stop a cycle and drain the water completely, turn the power off, then on, and then press Rinse+Spin.

Sorting Laundry



- The washer can be fully loaded, but the drum should not be tightly packed with items. The door of the washer should close easily.
- Use the Bedding cycle for buoyant or nonabsorbent items such as pillows or comforters. Failure to follow this caution can result in leakage.
- Clothing or articles that are waterproof or water resistant must be washed in the Bedding cycle only. (e.g. water resistant clothing, mattress covers, outdoor clothes, plastic mats, etc.) Otherwise, it may result in personal injury or damage to the washer, clothes, walls, floor, and surrounding objects due to abnormal vibration.
- Remove the stuffing from pillows and cushions before washing the covers. Failure to do so can cause excessive vibration, resulting in damage to the washer, clothes, nearby objects, walls, and floor.

Grouping Similar Items

For the best washing results, and to reduce the possibility of damage to clothing, care should be taken to sort the clothing into loads that are made up of similar items.

Mixing different fabric types and/or soil levels can result in poor wash performance, color transfer, discoloration, fabric damage or linting. Fabrics should be sorted into groups as described below.

Colors

Sort articles by color. Wash dark clothes together in a separate load from light colors or whites. Mixing dark clothes with light clothes can result in dye transfer or discoloration of the lighter clothes.

Soil Level

Wash heavily soiled clothing together. Washing lightly soiled clothing in the same load with heavily soiled clothing could result in poor wash performance for the lightly soiled clothing.

Fabric Type

Delicate articles should not be mixed with heavy or sturdy fabric types. Washing heavy fabrics in a delicate load can result in poor wash performance for the heavy fabrics and possible damage to the delicates.

Lint Type

Some fabrics attract and bind lint to them while others give off lint in the laundry process. Avoid mixing these lint collectors and lint producers in the same load. Mixing these fabrics will result in pilling and linting on the lint collectors. (For example, lint collector—knit sweater; lint producer—terry cloth towels.)











Sort Laundry

By colors	By Soil	By Fabric	By Lint
White	Heavy	Delicates	Lint Producer
Lights	Normal	Easy Care	Lint Collector
Darks	Light	Sturdy	

Fabric Care Labels

Many articles of clothing include a fabric care label. Using the chart below, adjust the cycle and option selections to care for your clothing according to the manufacturer's recommendations.



Category	Label	Directions
 Washing		Hand wash
		Machine wash, Normal cycle
		Perm Press/Wrinkle Resistant setting (which has a cool down or cold spray before the slower spin)
		Gentle/Delicate setting (slow agitation and/or reduced wash time)
		Do not wash
		Do not wring
Water Temperature	...	Hot
	..	Warm
	.	Cold/Cool
 Bleach Symbols		Any bleach (when needed)
		Only non-chlorine bleach (when needed)
		Do not bleach

Loading the Washer

- Check and empty pockets. Paper clips, coins, matches, etc. can damage clothing and the washer.
- Close zippers and hooks, and tie drawstrings to prevent snagging or tangling of clothes.
- Pretreat heavily stained areas for best results.
- Combine large and small items in a load. Load large items first. Large items should not be more than half of total load.
- The washer can be fully loaded, but the drum should not be tightly packed with items. The door of the washer must close easily.
- Do not wash single small items. Add 1-2 similar items to the load to prevent an out-of-balance load.
- Wash thick, bulky items individually. Heavy blankets, comforters, bedspreads, or pet beds can get tangled or cause an unbalanced load if combined with other items.
- Do not wash/spin waterproof items. Washing raincoats or sleeping bags may result in abnormal vibration or may cause the load to bounce, which could damage the drum.

- Wash small, light items in a mesh bag. Items like underwear can get caught in the door seal, and a brassiere hook may damage other items or the drum.
- Brush off heavy soil, dust, and hair from items before washing. Excess dirt or sand can abrade other fabrics and lead to poor wash performance.
- For best performance, load clothes as shown.

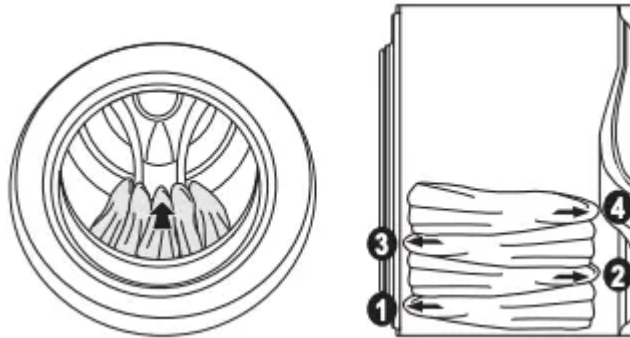

- Load clothes loosely, and do not overfill the drum. Clothes need room to circulate in order to get clean.
- Do not press down on items while stacking them in the drum.

Adding Cleaning Products

Loading the Dispenser

To add detergent, bleach, and fabric softener to the automatic dispenser.

- 1 Open the detergent dispenser drawer.

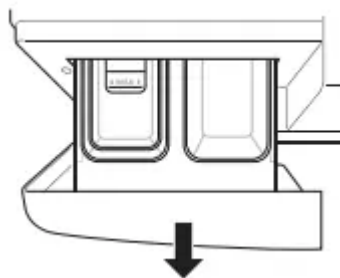

- 2 Load the laundry products into the appropriate compartments.

- If using a liquid detergent, make sure the liquid detergent cup is in place.
- If using a powdered detergent, remove the liquid detergent cup and put the powder in the main wash detergent compartment.
- If using detergent pods, place the pod in the drum before loading the laundry. Do not place liquid or powdered detergent pods in the dispenser.

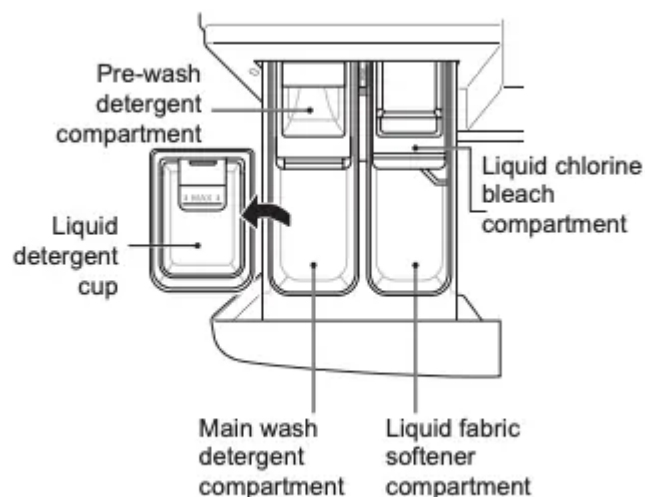

3 Close the detergent dispenser drawer slowly before starting the cycle.

- Slamming the detergent dispenser drawer may result in the detergent overflowing into another compartment or pouring into the tub earlier than programmed.

NOTE

- It is normal for a small amount of water to remain in the dispenser compartments at the end of the cycle.

IMPORTANT:

- Do not place or store laundry products, such as detergent, bleach, or liquid fabric softener, on top of your washer or dryer. Wipe up any spills immediately. These products can damage the machine's finish and controls.

Pre-Wash Detergent Compartment

Add liquid or powdered detergent to this compartment when using the Pre-Wash option. Always use HE (High-Efficiency) detergent with your washer.

- When using the Pre-Wash option, liquid detergent for the main wash needs to be loaded in the liquid detergent cup accessory in the main wash dispenser, to prevent it from being dispensed with the pre-wash detergent.
- The amount of detergent added for the Pre-Wash option is 1/2 the amount recommended for the main wash cycle. For example, if the main wash cycle requires one measure of detergent, add 1/2 measure for the Pre-Wash option.

Main Wash Detergent Compartment

This compartment holds laundry detergent for the main wash cycle. Either powdered or liquid detergent may be used in this compartment. The detergent is added to the load at the beginning of the cycle. Always use HE (High-Efficiency) detergent with your washer.



NOTE

- Never exceed the manufacturer's recommendations when adding detergent. Using too much detergent can result in detergent buildup in clothing and the washer.
- Liquid or powdered color-safe bleach may be added to the main wash compartment with detergent of the same type.
- When using liquid detergent, make sure the liquid detergent cup and insert are in place. Do not exceed the maximum fill line.
- When using powdered detergent, remove the insert and liquid detergent cup from the compartment. Powdered detergent will not dispense with the liquid detergent cup and insert in place.
- If you use a detergent that does not dissolve easily or a detergent with high viscosity, it will leave a residue and may clog on the dispenser.

Liquid Bleach Compartment

This compartment holds liquid bleach, which is dispensed automatically at the proper time during the wash cycle. The dispenser is activated twice to ensure complete dispensing of the bleach. Any liquid remaining in the dispenser at the end of the cycle is water, not bleach.

- Do not add powdered bleach to this compartment. The bleach compartment is designed to dispense liquid chlorine bleach only. Powdered or liquid colorsafe bleach will not dispense properly.
- Always follow the manufacturer's recommendations when adding bleach. Never add more than one cup and do not exceed the maximum fill line since this can cause the bleach to be dispensed immediately, resulting in damage to fabrics. Using too much bleach can damage fabrics.
- Never pour undiluted liquid chlorine bleach directly onto the load or into the drum. Fabric damage can occur.
- Do not use color-safe bleach or Oxi products in the same cycle with liquid chlorine bleach.



WARNING

- Do NOT mix chlorine bleach with ammonia or acids such as vinegar or rust/scale remover. Mixing chemicals like these can produce a lethal gas, resulting in severe injury or death.

Fabric Softener Compartment

This compartment holds liquid fabric softener, which is automatically dispensed during the final rinse cycle. Do not exceed the manufacturer's recommendations when adding softener. Using too

much fabric softener can result in buildup in clothing and the washer. Either powdered or liquid fabric softener may be used.

- Follow the manufacturer's recommendations when adding fabric softener. Do not exceed the maximum fill line. Using too much fabric softener may stain clothes.
- Dilute concentrated fabric softeners with warm water. Do not exceed the maximum fill line.
- Never pour fabric softener directly onto the load or into the drum.

Detergent Use

This washer is designed for use with only HE (HighEfficiency) detergents. HE detergents produce fewer suds, dissolve more efficiently to improve washing and rinsing performance, and help to keep the interior of the washer clean. Using detergent that is not HE may cause oversudsing and unsatisfactory performance which could result in error codes, cycle failure, and machine damage.



Designed specially to use only HE (High-Efficiency) detergent

- For proper wash performance, always measure detergent using the measuring device provided by the detergent manufacturer. For an average load, use less than half of the recommended maximum. Use less detergent for soft water, light soil, or smaller loads.
- Never use more than the maximum amount of detergent recommended by the manufacturer. Using too much detergent can lead to oversudsing, poor rinsing, detergent buildup in clothing, and residue buildup that can contribute to odors in the machine.
- Use extra care when measuring 2X and 3X concentrated detergents because even a small amount extra can lead to problems.
- Detergents designated as HE-compatible may not provide optimal results.
- Do not use more than one detergent pod in the washer. Using too much detergent may cause oversudsing and unsatisfactory performance. Reduce detergent amount or add an extra rinse if detergent residue is left on fabrics. To add an extra rinse, press the Extra Rinse button.

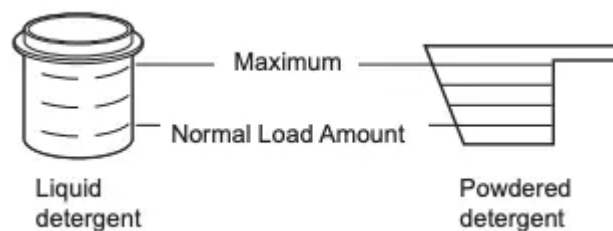

Detergent Pods

Place liquid or powdered detergent pods in the drum before loading laundry. Do not place pods in the dispenser.

Control Panel

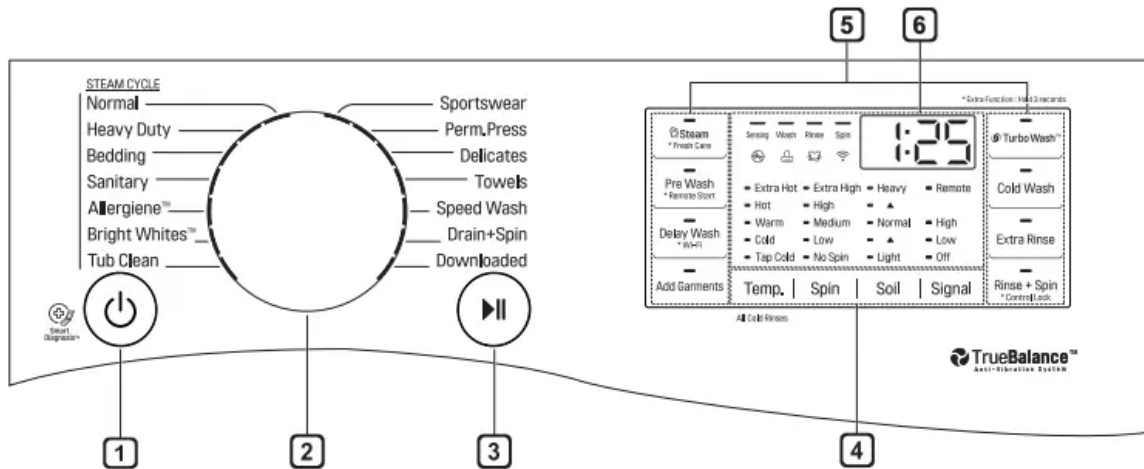

Control Panel Features

1 Power On/Off Button

Press to turn the washer on. Press again to turn the washer off. Pressing the Power button during a cycle will cancel that cycle and any load settings will be lost. The door will unlock after a brief pause.

2 Cycle Selector Knob

Turn this knob to select the desired cycle. Once the desired cycle has been selected, the standard presets will be shown in the display. These settings can be adjusted using the cycle modifier buttons any time before starting the cycle.

- To protect your clothing, not all settings are available on all cycle selections.

3 Start/Pause Button

Press this button to start the selected cycle. If the washer is running, use this button to pause the cycle without losing the current settings.

- If Start/Pause is not pressed within 60 minutes of selecting a cycle, the washer automatically turns off and all cycle settings are lost.

4 Cycle Modifier Buttons

Use these buttons to adjust the water temperature, spin speed and soil level settings for the selected cycle. The current settings are shown in the display. Press the button for that option to select other settings.

5 Special Cycle and Option Buttons

Press these buttons to select special cycles or additional cycle options. Certain buttons also allow you to activate special functions by pressing and holding the button for three seconds.

6 Time and Status Display

The display shows the settings, estimated time remaining, options, and status messages for your washer. When the washer is turned on, the default settings in the display will illuminate.

Time and Status Display

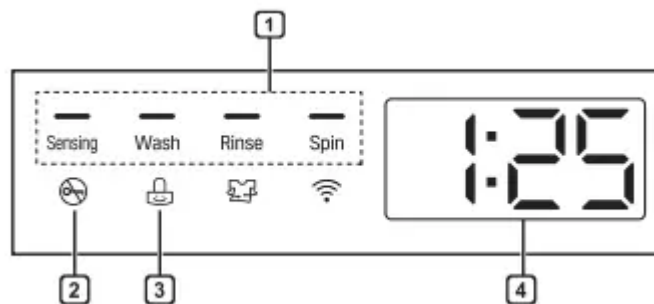

1 Cycle Status Indicator

These LEDs illuminate when a cycle is selected to indicate which stages run. When a cycle is running, the LED for the active stage blinks, and the LEDs for the remaining stages remain steady. Once a stage is complete, the LED turns off. If a cycle is paused, the active stage LED stops blinking.

2 Door Lock Indicator

The Door Lock indicator will light up once a cycle has started. The indicator light will stay on until the cycle is paused, stopped or has finished.

3 Control Lock Indicator

When the control lock function is activated, the LED lights up. When the control lock function is set, all controls are disabled except for the Power button. Once the control lock function is disabled, the LED turns off.

4 Estimated Time Remaining

When a cycle is selected, the default time for that cycle is displayed. This time will change as modifiers or options are selected. Once the Start/Pause button is pressed, the washer will measure the size of the load. The estimated time may change once the load size has been measured. If Delay Wash is set, the remaining delay time counts down until the cycle begins.

NOTE

- The time shown is only an estimate. This time is based on normal operating conditions. Several external factors (load size, room temperature, incoming water temperature, etc.) can affect the actual time.

Wash Cycles

Wash cycles are designed for the best wash performance for each type of load. Select the cycle that best matches the load contents for maximum wash performance and fabric care. See the Sorting Laundry section for best results, follow the fabric care labels on your garments. For a guide to fabric care symbols, see the Sorting Laundry section.

Press the button to select the desired cycle. When you select a wash cycle, the light for the corresponding wash cycle will turn on.

NOTE

- Whenever load weights are mentioned, assume 1 lb (0.45 kg) = 1 thick bath towel (dry).
- For information on using LG SmartThinQ applications to save energy, see the SMART FUNCTIONS section.

Choosing by	Wash Cycle	Description
Fabric Type	Normal	Use this cycle to wash all normal items, except delicate fabrics such as wool or silk. NOTE: Pressing the Start/Pause button without selecting a cycle will cause the Normal cycle to begin immediately, using the default settings.
	Bright Whites™	This cycle is for washing white items only. (less than 15 lb. (6.8 kg))
	Perm.Press	Use this cycle to wash wrinkle-free clothes or tablecloths, to minimize wrinkles.
	Delicates	This cycle is for washing lingerie or sheer and lacy clothes which can easily be damaged.
	Towels	Use this cycle for washing towels, shirts, jeans and mixed loads.
	Sportswear	Use this cycle for garments that are specially designed and treated for sport.
Load Size	Normal	If you have a mixed load that is half-size, use the Normal cycle with default settings. For full-size loads, use the Normal cycle with the soil level set to heavy, and add an extra rinse. In both cases, the machine will automatically detect the load size and adjust accordingly.
	Bedding	This cycle is for washing king or queen sized comforters. NOTE: Use the Bedding cycle with a low spin speed when washing waterproof or water-resistant items, to help protect the fabrics' properties. If your washer does not function properly, manually redistribute the load or put one comforter in at a time.
	Speed Wash	Use the Speed Wash cycle to quickly wash lightly soiled clothing and small loads. For high wash and rinse efficiency, wash small loads of 2-3 lightly soiled garments(less than 3 lb. (1.36 kg)). NOTE: Use very little detergent in this cycle. To add an extra rinse, use the Extra Rinse button.

Choosing by	Wash Cycle	Description
Convenience	Tub Clean	Use this cycle to clean the drum of your washer. See the Maintenance section.
	Speed Wash	Use the Speed Wash cycle to quickly wash lightly soiled clothing and small loads. For high wash and rinse efficiency, wash small loads of 2-3 lightly soiled garments(less than 3 lb. (1.36 kg)). NOTE: Use very little detergent in this cycle. To add an extra rinse, use the Extra Rinse button.
	Downloaded	If you download a cycle using the function, it will be placed in the Downloaded cycle position. Choose the Downloaded cycle to run the new cycle. NOTE: The default cycle for this position is Small Load, used for normally soiled loads with just a few items. The Small Load cycle is also available for download.
Soil Level	Normal	For tough stains on children's clothes, use the Normal cycle with a hot Wash Temp. setting, plus the Pre Wash option and an Extra Rinse.
	Heavy Duty	This cycle is for washing heavily soiled laundry using more powerful wash motions.
	Sanitary	This wash cycle reduces 99% of bacteria on laundry through high temperature.
	Allergiene™	This cycle is a powerful, high-temperature cycle designed specifically to reduce certain allergens. NOTE: Selecting the Allergiene™ cycle automatically incorporates steam into the wash cycle. The Allergiene™ cycle can significantly reduce allergens in bedding and clothing. The Allergiene™ cycle helps reduce dust mite populations and helps reduce allergens. Due to the higher energy and temperatures used, the Allergiene™ cycle is not recommended for wool, silk, leather, or any other delicate or temperature sensitive items.



Cycle Guide

Cycle	Cycle Modifiers	Temp.	Spin	Soil	Delay Wash	Extra Rinse	Fresh Care
Normal		Extra Hot	Extra High	Heavy	●	●	●
	Turbo Wash™	Hot	High	▲			
	Steam	Warm	Medium	Normal			
	Cold Wash	Cold	Low	▲			
	Pre Wash	Tap Cold	No Spin	Light			
Heavy Duty		Extra Hot	Extra High	Heavy	●	●	●
	Turbo Wash™	Hot	High	▲			
	Steam	Warm	Medium	Normal			
	Cold Wash	Cold	Low	▲			
	Pre Wash	Tap Cold	No Spin	Light			
Bedding				Heavy	●	●	●
	Turbo Wash™	Hot		▲			
	Steam	Warm	Medium	Normal			
	Cold Wash	Cold	Low	▲			
	Pre Wash	Tap Cold	No Spin	Light			
Sanitary		Extra Hot	Extra High	Heavy	●	●	●
	Turbo Wash™		High	▲			
	Steam		Medium	Normal			
			Low	▲			
	Pre Wash		No Spin	Light			
Allergiene™			Extra High		●	●	●
	Turbo Wash™		High				
	Steam		Medium				
			Low				
			No Spin				
Bright Whites™			Extra High	Heavy	●	●	●
	Turbo Wash™	Hot	High	▲			
	Steam	Warm	Medium	Normal			
		Cold	Low	▲			
	Pre Wash	Tap Cold	No Spin	Light			
Tub Clean					●		
	Steam						

● = available option, ■ = default setting

- Steam and Cold Wash can't be selected at same time.

Cycle	Cycle Modifiers	Temp.	Spin	Soil	Delay Wash	Extra Rinse	Fresh Care
Sportswear				Heavy			
				▲			
		Warm	Medium	Normal	●	●	●
		Cold	Low	▲			
		Tap Cold	No Spin	Light			
Perm.Press				Heavy			
	Turbo Wash™	Hot	High	▲			
		Warm	Medium	Normal	●	●	●
	Cold Wash	Cold	Low	▲			
	Pre Wash	Tap Cold	No Spin	Light			
Delicates				Heavy			
				▲			
		Warm	Medium	Normal	●	●	●
	Cold Wash	Cold	Low	▲			
	Pre Wash	Tap Cold	No Spin	Light			
Towels			Extra High	Heavy			
	Turbo Wash™	Hot	High	▲			
		Warm	Medium	Normal	●	●	●
	Cold Wash	Cold	Low	▲			
	Pre Wash	Tap Cold	No Spin	Light			
Speed Wash			Extra High	Heavy			
	Turbo Wash™	Hot	High	▲			
		Warm	Medium	Normal	●	●	●
	Cold Wash	Cold	Low	▲			
		Tap Cold	No Spin	Light			
Drain+Spin			Extra High				
			High				
			Medium		●		●
			Low				
			No Spin				
Downloaded Default: Small Load			Extra High	Heavy			
		Hot	High	▲			
	Cold Wash	Warm	Medium	Normal	●	●	●
	Pre Wash	Cold	Low	▲			
		Tap Cold	No Spin	Light			

● = available option, ■ = default setting

- Steam and Cold Wash can't be selected at same time.

Cycle Modifier Buttons

Each cycle has default settings that are selected automatically. Customize these settings using the cycle modifier buttons. Press the button for the desired modifier to toggle through the available settings. The washer automatically adjusts the water level for the type and size of wash load for best results and maximum efficiency. Due to the high-efficiency nature of this product, water levels



may be much lower than expected. This is normal and cleaning/rinsing performance will not be compromised.

• Extra Hot	• Extra High	• Heavy	• Remote
• Hot	• High	• ▲	
• Warm	• Medium	• Normal	• High
• Cold	• Low	• ▲	• Low
• Tap Cold	• No Spin	• Light	• Off
Temp.	Spin	Soil	Signal

Temp.

Temp. selects the wash and rinse temperature combination for the selected cycle. Press the Temp. button until the indicator light for the desired setting is lit. All rinses use tap cold water .

Cold rinses use less energy. The actual cold rinse temperature depends on the temperature of the cold water at the faucet.

Your washer features a heating element to boost the hot water temperature for Extra Hot settings. This provides improved wash performance at normal water heater settings.

- Select the water temperature suitable for the type of load you are washing. Follow the garment fabric care labels for best results.

Spin

Higher spin speeds extract more water from clothes, reducing drying time and saving energy.

Press the Spin button until the desired speed is selected. Some fabrics, such as delicates, require a slower spin speed. To protect your clothing, not all spin speeds are available for all cycles.

- The Spin button also activates the Drain+Spin cycle to drain the tub and spin clothes; for example, if you want to remove clothes before the cycle has ended. To use Drain+Spin, press the Power button, then press the Spin button repeatedly to select a spin speed. Press the Start/Pause button to begin.

Soil

Adjusting the soil level setting will modify the cycle times and/or wash actions. Press the Soil button until the desired soil level is selected.

- This feature needs more time for heavily soiled loads or less time for lightly soiled loads.

Signal

The washer plays a melody when the wash cycle is finished. The buttons make a sound each time a button is pressed. Use this option to adjust the volume of the melody and button tones.

Option Buttons

Your washer features several additional cycle options that customize cycles to meet your individual needs. To use these options, select the desired option after selecting the desired cycle.

After selecting the desired cycle and settings, press the cycle option button(s) for the option(s) you would like to add. The button will light when that option is selected. If the selected option is not allowed for the selected cycle, the chime will sound twice to alert you and the LED will not illuminate.

NOTE

- To protect your garments, not every feature is available with every cycle.
- If the Start/Pause button is not pressed within 60 minutes to start the cycle, the control will shut off and all settings will be lost.

Steam

Adding the Steam option to a wash cycle helps provide superior cleaning performance. By using hot steam, the fabrics will get the cleaning benefits of a very hot wash.

NOTE

- The Steam option cannot be used with all cycles.
- Steam may not be clearly visible during the steam cycles. This is normal. Too much steam could damage clothing.
- Do not use steam with delicate fabrics such as wool, silk, or easily discolored fabrics.



WARNING

- Do not touch the door during steam cycles. The door surface can become very hot. Allow the door lock to release before opening the door.
- Do not attempt to override the door lock mechanism or reach into the washer during a steam cycle. Steam can cause severe burns.

Fresh Care

Use this function when you won't be able to unload your clothes immediately after the wash cycle ends. After the cycle ends, the drum will tumble periodically for up to 19 hours to prevent wrinkles.

1 Press and hold the Fresh Care button for 3 seconds.

2 Press the Start/Pause or Power button at any time to unload laundry

Pre Wash

A 15-minute prewash for clothes that are covered in dirt or dust. This feature is suitable for heavily soiled items.

Delay Wash

Once you have selected the cycle and other settings, press this button to delay the start of the wash cycle. Each press of the button increases the delay time by hour, for up to 19 hours. Once the desired delay time is set, press the Start/Pause button to start the delay time.

NOTE

- If the Start/Pause button is not pressed to begin the delay time, the washer will automatically shut off after 60 minutes and all cycle settings will be lost.

Add Garments

Use this function to add garments or remove foreign objects like coins or keys after the cycle has started.

1. Press Add Garments. The cycle pauses and the door unlocks.
2. Open the door, add garments or remove foreign objects, and close the door.
3. Press the Start/Pause button to start the cycle. The cycle continues automatically.

NOTE

- After checking the water level/temperature conditions for safety, the door unlocks once the wash movement has stopped. (Door Lock LED turns off.)
- If the water level is too high, the door will not unlock, and the Add Garments option cannot be used.
- If the temperature in the tub is higher than 113 °F (45 °C), a short warning chime sounds and Add Garments is not allowed for safety.
- Add Garments is disabled during the Tub Clean cycle or while a cycle is in Spin mode for safety.
- To preserve wash performance, wash time may be extended depending on when garments are added to a cycle.

WARNING

- Be careful when opening the door as wet laundry may drip or fall out when the door is opened.
- Do not attempt to force the door to open when locked. Doing so could result in damage to the machine, malfunction, or personal injury

Turbo Wash™

Adding the Turbo Wash™ option reduces the cycle time while still providing similar wash performance to the same cycle without Turbo Wash™.

NOTE

- The Turbo Wash™ option cannot be used with all cycles.
- Turbo Wash™ defaults to on for Normal, Heavy Duty and Perm.Press wash cycles.

Cold Wash

This option saves energy by using cooler water while increasing the wash and rinse times to maintain wash performance.

NOTE

- Wash time will increase up to several minutes with the Cold Wash option.
- For best wash results, only wash small loads (less than 8 lb) with the Cold Wash option.

Extra Rinse

This option will add an extra rinse to the selected cycle. Use this option to help ensure the removal of detergent or bleach residue from fabrics. Liquid fabric softener, if used, is always dispensed in the final rinse. Pressing the Extra Rinse button twice will add two additional rinses to the cycle.

Rinse+Spin

Select this cycle to rinse and spin a load separately from a regular cycle. This can be helpful in preventing fresh stains from setting in fabrics. You can change the spin speed by pressing the Spin button.

1. Press the Power button to turn on the washer.
2. Press the Rinse+Spin button.
3. Press the Start/Pause button to start the cycle.

Control Lock

Use this option to disable the controls. This feature can prevent children from changing cycles or operating the machine. The feature does not lock the door. Once the Control Lock is set, it must be deactivated before any controls, except the Power button, can be used. Once the washer has shut off, the Power button will allow the machine to be turned on, but the controls will still be locked.

When the controls are locked,  will display alternately with the estimated time remaining.

Locking/Unlocking the Control Panel

Press and hold the Control Lock button for 3 seconds.

NOTE



- Turning off the power will not reset the Control Lock function. You must deactivate Control Lock before you can access any other functions.
- When Control Lock is turned on, you cannot operate any buttons except the Power button.

SMART FUNCTIONS

LG SmartThinQ Application

The LG SmartThinQ application allows you to communicate with the appliance using a smartphone.

Before Using LG SmartThinQ

- For appliances with the  or  logo
 - 1 Use a smartphone to check the strength of the wireless router (Wi-Fi network) near the appliance.
- If the distance between the appliance and the wireless router is too far, the signal strength becomes weak. It may take a long time to register or installation may fail.
 - 2 Turn off the Mobile data or Cellular Data on your smartphone.

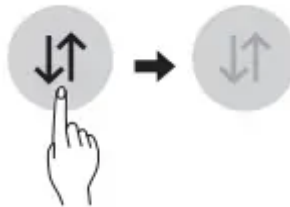

- 3 Connect your smartphone to the wireless router

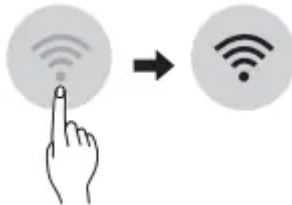

NOTE



- To verify the Wi-Fi connection, check that Wi-Fi icon on the control panel is lit.
- The appliance supports 2.4 GHz Wi-Fi networks only. To check your network frequency, contact your Internet service provider or refer to your wireless router manual.
- LG SmartThinQ is not responsible for any network connection problems or any faults, malfunctions, or errors caused by network connection.
- The surrounding wireless environment can make the wireless network service run slowly.
- If the appliance is having trouble connecting to the Wi-Fi network, it may be too far from the router. Purchase a Wi-Fi repeater (range extender) to improve the Wi-Fi signal strength.

- The network connection may not work properly depending on the Internet service provider.
- The Wi-Fi connection may not connect or may be interrupted because of the home network environment.
- If the appliance cannot be registered due to problems with the wireless signal transmission, unplug the appliance and wait about a minute before trying again.
- If the firewall on your wireless router is enabled, disable the firewall or add an exception to it.
- The wireless network name (SSID) should be a combination of English letters and numbers. (Do not use special characters.)
- Smartphone user interface (UI) may vary depending on the mobile operating system (OS) and the manufacturer.
- If the security protocol of the router is set to WEP, network setup may fail. Change the security protocol (WPA2 is recommended), and register the product again.

Installing the LG SmartThinQ Application

Search for the LG SmartThinQ application from the Google Play Store or Apple App Store on a smart phone. Follow instructions to download and install the application.

LG SmartThinQ Application Features

- For appliances with the  or  logo

Washer Cycle (Remote Start, Downloaded)

Set or download any preferred cycle and operate by remote control.

Tub Clean Coach

This function shows how many cycles remain before it is time to run the Tub Clean cycle.

Smart Diagnosis™

This function provides useful information for diagnosing and solving issues with the appliance based on the pattern of use.

Energy Monitoring

The washer energy usage is affected by the cycles and options so you may see some changes in energy usage from one cycle to another.

Push Alerts

When the cycle is complete or the appliance has problems, you have the option of receiving push notifications on a smart phone.

Settings

Set the product nickname and delete product.

NOTE

- If you change your wireless router, Internet service provider, or password, delete the registered appliance from the LG SmartThinQ application and register it again.
- This information is current at the time of publication. The application is subject to change for product improvement purposes without notice to users.

Using Washer Cycle

Remote Start

Use a smart phone to control the appliance remotely or check to see how much time is left in the cycle.

Using Remote Start

1. Press the Power button.
2. Load the laundry.
3. Press and hold Remote Start button for 3 seconds to enable the Remote Start function.
4. Start a cycle from the LG SmartThinQ application on your smart phone.

NOTE

- Once the Remote Start mode is enabled, you can start a cycle from the LG SmartThinQ smartphone application. If the cycle is not started, the machine will wait to start the cycle until it is turned off remotely from the application or the Remote Start mode is disabled.
- When Remote Start is turned on, the door is automatically locked.

Disabling Remote Start

When the Remote Start is activated, press and hold the Remote Start button for 3 seconds.

Downloaded

Download new and specialized cycles that are not included in the standard cycles on the appliance.

Appliances that have been successfully registered can download a variety of specialty cycles specific to the appliance.

Only one cycle can be stored on the appliance at a time.

Once cycle download is completed in the appliance, the appliance keeps the downloaded cycle until a new cycle is downloaded.

MAINTENANCE

WARNING

To reduce the risk of fire, electric shock, or injury to persons, read this entire owner's manual, including the Important Safety Instructions, before operating this washer.

- Unplug the washer before cleaning to avoid the risk of electric shock. Failure to follow this warning can cause serious injury, fire, electric shock, or death.
- Do not use volatile substances (benzene, paint thinner, alcohol, acetone, etc.), abrasive cleaners, or detergents with strong chemical components when cleaning the washer. Doing so may cause discoloration or damage to the machine, or may cause a fire.
- Certain internal parts are intentionally not grounded and may present a risk of electric shock only during servicing. Service personnel - Do not contact the following parts while the appliance is energized: pump, valve, motor, control board.

Regular Cleaning

Care After Wash

After the cycle is finished, wipe the door and the inside of the door seal to remove any moisture.

- Leave the door open to dry the drum interior.
- Wipe the body of the washer with a dry cloth to remove any moisture.

Cleaning the Exterior

Proper care of your washer can extend its life.

Door:

Wash with a damp cloth on the outside and inside and then dry with a soft cloth.

Exterior:

- Immediately wipe off any spills.
- Wipe with a damp cloth.
- Do not touch the surface or the display with sharp objects.

Care and Cleaning of the Interior

- Use a towel or soft cloth to wipe around the washer door opening and door glass.
- Always remove items from the washer as soon as the cycle is complete. Leaving damp items in the washer can cause wrinkling, color transfer, and odor.
- Run the Tub Clean cycle once a month, or more often if needed, to remove detergent buildup and other residue

Cleaning the Drum

Over time, residue may build up in the drum, leading to mildew or a musty odor. Run the Tub Clean cycle monthly to remove residue and prevent odor. Run the cycle more often under heavy use conditions or if odor is already present.

1. Remove any clothing from the drum.
2. Add cleaning agents.

Cleaner	Instructions
Drum cleaner	Add to main detergent compartment of detergent dispenser
Lime scale remover	
Liquid chlorine bleach	Add to bleach compartment of detergent dispenser
Powdered cleaner	Pull out liquid detergent cup before adding to main detergent compartment
Cleaning tablets	Place directly into washer drum

- For other drum cleaning products, follow the cleaner manufacturer's instructions and recommendations.
 - Do not exceed the maximum fill line when adding bleach or powdered cleaners. Powdered detergent may remain in the drum after cleaning.
3. Close the door and press the Power button to turn the washer on.
 - 4 Turn the cycle selector to select the Tub Clean cycle.
 - 5 Press the Start/Pause button to begin the cycle. Selecting any other cycle after Tub Clean has been selected will cause the Tub Clean cycle to be cancelled.
 - 6 After the cycle ends, open the door and allow the drum interior to dry completely

NOTE

- Never load laundry while using Tub Clean. The laundry may be damaged or contaminated with cleaning products. Make sure to run the Tub Clean cycle only when the drum is empty.
- Leave the door open after finishing the laundry, to keep the drum clean.
- Tub Clean should be repeated monthly.
- If mildew or musty smell already exists, run Tub Clean once a week for three consecutive weeks.

Automatic Alert for Tub Clean

When the power is on and the message blinks on the **tcL** display, it means the washer drum needs cleaning. Use the Tub Clean cycle to clean the washer drum. The frequency of the automatic alert's appearance depends on how often the washer is used, however the message will generally appear every one to two months.

Removing Mineral Buildup

In areas with hard water, mineral scale can form on internal components of the washer. Periodically clean the mineral buildup on the internal components to extend the lifespan of the washer. Use of a water softener is recommended in areas with hard water.

- Use a descaler, such as Washer Magic®, to remove visible mineral buildup on the washer drum.

After descaling, always run the Tub Clean cycle before washing clothing.

- Mineral scale and other spots may be removed from the stainless steel drum using a soft cloth soaked in stainless steel cleaner.
- Do not use steel wool or abrasive cleaners.

NOTE

- If you use a descaler or tub cleaner during the Tub Clean cycle, use the Rinse+Spin cycle to rinse the washer drum before running your next wash cycle.

Cleaning the Detergent Dispenser Drawer

Leaving detergent in the detergent dispenser drawer for an extended period of time or using the washing machine for a long period of time may cause the build-up of scales in the detergent dispenser drawer. Pull out and clean the detergent dispenser drawer once a week.

- 1 Slide the detergent dispenser drawer out as far as it will go.
- 2 Press down hard on the disengage button and pull out the detergent dispenser drawer.

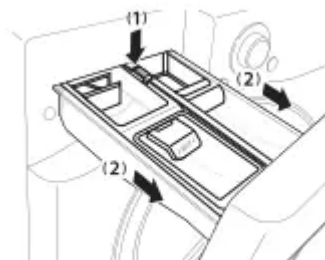

- 3 Remove the inserts from the drawer.
 - 4 Clean the inserts with warm water.
- Use a soft cloth or brush to remove any residue.
 - Use water only when cleaning the drawer and inserts.

5 Wipe off any moisture with a dry towel or cloth after cleaning.

6 Replace the detergent dispenser drawer.

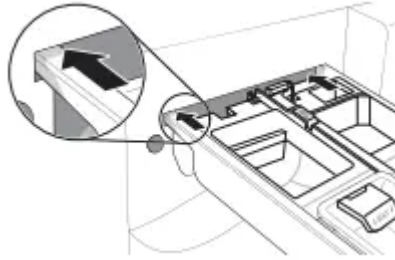

WARNING

- Do not spray water inside the cabinet. Doing so may cause fire or electric shock.

Cleaning the Door Seal

Clean the door seal once a month to prevent build-up of dirt.

1. Wear rubber gloves and protective goggles.
2. Dilute 3/4 cup (177 ml) of liquid chlorine bleach in 1 gallon (3.8 L) of water.
3. Wipe around the door seal. Soak a sponge or a soft cloth in this diluted solution and wipe all around the door seal.
4. Wipe dry. After cleaning, wipe up any moisture with a dry towel or cloth.
5. Leave the door open to allow the door seal to dry completely

CAUTION

- Cleaning the door seal with undiluted bleach may cause malfunction of the door seal and washer parts. You must add water to the bleach before using it.

Cleaning the Water Inlet Filters

If the washer does not fill properly, an error message will show on the display. The inlet valve filter screens could be plugged by hard water scale, sediment in the water supply, or other debris.

CAUTION

- The inlet screens protect the delicate parts of the inlet valve from being damaged by particles that could enter the valves with the water supply. Operating the washer with these filters removed could cause a valve to stick open resulting in flooding and/or property damage

- If you use the washer in an area with hard water, the inlet filter may clog due to lime buildup.
1. Turn off both water faucets completely.
 2. Unscrew the hot and cold water hoses from the back of the washer.
 3. Carefully remove the filters from the water valves.
 4. Remove foreign objects and soak the filters in white vinegar or a lime scale remover. If using a lime scale remover, follow the manufacturer's instructions. Be careful not to damage the filters while cleaning them.
 5. Rinse filters thoroughly and press them back into place.
 6. Flush then reattach the water hoses. Before reattaching the hoses, flush the hoses and water lines by running several gallons of water into a bucket or drain, preferably with the faucets wide open for maximum flow.

NOTE

- An **IE** message may blink on the display when the water pressure is weak or an inlet filter is clogged with dirt. Clean the inlet filter.

Cleaning the Drain Pump Filter

The washer fails to drain if the drain pump filter is clogged. Periodically clean the drain filter to prevent clogging with foreign objects.

WARNING

- Opening the drain filter will result in water overflowing if there is water in the washer drum. Use a bucket if the drum is not completely drained before you open the drain filter.
- Using the washer without the drain filter or with an incorrectly assembled drain filter may cause leaks or malfunctioning of the washer.

- 1 Turn off the machine and unplug it.
- 2 Open the drain pump filter cover.

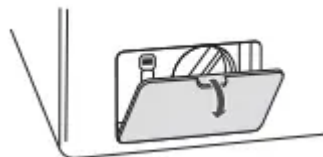

- 3 Drain any remaining water. Unclip the drain hose and remove the plug from the drain hose to drain the remaining water.



4 Remove the pump filter. Twist the pump filter counterclockwise to remove.



5 Clean the pump filter and opening

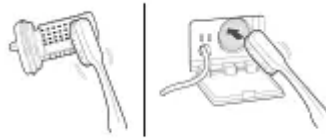

6 Recap the plug onto the drain hose and attach the drain hose.

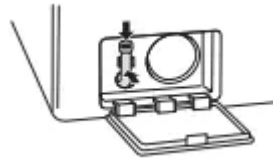

7 Insert the drain pump filter.

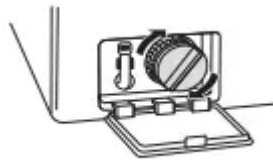

8 Close the drain pump filter cover.

NOTE

- An **OE** message blinks on the display when the drain pump filter is clogged with dirt. Clean the drain pump filter.

Care in Cold Climates

Storing the Washer

If the washer will not be used for an extended period of time and is in an area that could be exposed to freezing temperatures, perform the following steps to protect the washer from damage.

1. Turn off the water supply.

2. Disconnect the hoses from the water supply and drain any water from the hoses.

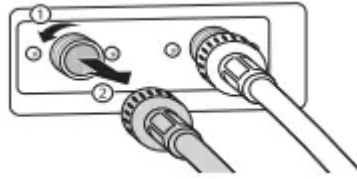

3. Plug the power cord into a properly grounded electrical outlet.
- 4 Add 1 gallon of nontoxic recreational vehicle (RV) antifreeze to the empty drum and close the door. Never use automotive antifreeze.
- 5 Press the Power button, then select Spin.
- 6 Press the Start/Pause button to start the drain pump.
- 7 Allow the drain pump to run for one minute, then press the Power button to shut off the washer. This will expel some of the antifreeze, leaving enough to protect the washer from damage.
- 8 Unplug the power cord, dry the drum interior with a soft cloth, and close the door.
- 9 Remove the inserts from the dispenser. Drain any water in the compartments and let them dry.
- 10 Store the washer in an upright position.
- 11 To remove the antifreeze from the washer after storage, run a complete Speed Wash cycle using detergent.
 - Do not add laundry to this cycle.

When the Water Line is Frozen

1. Turn off the faucets connected to the water lines.
2. Pour hot water on the frozen faucets to thaw the water lines and remove them.
3. Immerse the water lines in hot water to thaw them.
4. Connect the water lines with the water inlets of the washer and with the faucets. See Connecting the Water Lines for details.
5. Turn on the faucets.
6. Press the Power button.
7. Press the Spin button.
8. Press the Start/Pause button. Verify the water fills properly.

When the Drain Line is Frozen

1. Pour hot water in the washer drum and close the lid. Wait for 1-2 hours.
2. Press the Power button after thawing.

3. Press the Spin button to select draining and spinning.
4. Press the Start/Pause button. Check to make sure the water drains.

TROUBLESHOOTING

FAQs: Frequently Asked Questions

Q: Why does my washer make loud banging noises while it is filling with water?

A: This is actually a problem with the plumbing in your home. When the water valve in the washer shuts off, it can cause pipes in your home to move, resulting in a loud banging noise. This effect, called water hammer, can be reduced by installing an item called a water hammer arrestor. Add-on arrestors can be purchased through your local hardware or home improvement store.

Q: Why is there so little water in my washer? How can it clean the clothes?

A: HE (High-Efficiency) washers are designed to properly wash your laundry while using a minimum amount of water and energy. Because the water volume is low, the small amount of detergent used is more concentrated in the water, resulting in excellent cleaning performance.

Q: When I press a button, why does my washer beep and then nothing happens?

A:

- The Control Lock feature is turned on. To turn off Control Lock, turn the washer on, then press and hold the button that has "Control Lock" on or under it for three seconds.
- Power or Signal is off.

Q: Where should I pour my OxiClean™ or other powdered laundry products when doing my laundry?

A: If you are using powdered laundry detergent, load it in the main detergent dispenser after removing the liquid detergent insert. Powdered laundry agents such as OxiClean™ or powdered color safe bleach should be put directly into the tub. These products can be put in the empty tub before loading or on top of the laundry after loading the machine.

Before Calling for Service

The washer is equipped with an automatic error-monitoring system to detect and diagnose problems at an early stage. If the washer does not function properly or does not function at all, check the following before you call for service.

Noises You Might Hear

Spraying or Hissing

Water spraying or circulating during the cycle.

- Normal Operation

Humming or Gurgling

Drain pump is pumping water from the washer at times during a cycle.

- Normal Operation

Water sloshing

A liquid in the balance ring around the wash basket helps the basket spin smoothly.

- Normal Operation

Water being added after the washer has already begun to operate

The washer adapts to the load size and type to add more water to the cycle as needed.

The wash load may be unbalanced. If the washer senses that the load is unbalanced, it will stop and refill to redistribute the load.

The washer may be diluting laundry additives to add to the wash load.

- Normal Operation

Rattling and clanking noise

Foreign objects, such as keys, coins, or safety pins may be in drum or pump.

- Stop washer, check drum and drain filter for foreign objects. If noise continues after washer is restarted, call for service.

Thumping sound

Heavy wash loads may produce a thumping sound.

- This is normal. If sound continues, washer is probably out of balance. Stop and redistribute wash load.

Wash load may be out of balance.

- Pause the cycle and redistribute the load.

Vibrating noise

Packaging materials were not removed.

- See the Unpacking and Removing Shipping Bolts information in the Installation section.

Wash load may be unevenly distributed in the drum.

- Pause the cycle and redistribute the load.

Not all leveling feet are resting firmly and evenly on the floor.

- See Leveling the Washer in the Installation section.

Floor not rigid enough.

- Make sure that the floor is solid and does not flex. See the Flooring in the Installation section.

Squeaking noise

Packaging materials were not removed.

- See the Unpacking and Removing Shipping Bolts information in the Installation section.

Banging noise when washer is filling with water (Water Hammer)

Plumbing in the home moves or flexes when the water valves in the washer shut off.

- Water hammer is not caused by a defect in the washer. Install water hammer arrestors (purchased separately at hardware or home improvement store) between the fill hose and the washer for best results.

Household water supply pressure is very high.

- Adjust household water supply regulator to a lower pressure or contact a plumber.

Water leaking

Inlet hose connection is loose at faucet or washer.

- Check hoses for leaks, cracks and splits.
- Check and tighten hose connections.

House drain pipes are clogged.

- The washer pumps out water very rapidly. Check for water backing up out of the drain pipe during drain. If water is seen coming out of the drain, check for proper drain hose installation and check for restrictions in the drain. Contact a plumber to repair drain pipe.

Drain hose has come out of drain or is not inserted far enough.

- Tie drain hose to inlet hose or standpipe to prevent it from coming out during drain. For smaller drain pipes, insert the drain hose into the pipe as far as the drain hose flange. For larger drain pipes, insert the drain hose into the pipe 1-2 inches past the flange.

A large item such as a pillow or blanket is above the top of the drum.

- Use the Bedding cycle for large or bulky items. Use extra care and never wash more than half a load of items that float, such as pillows.
- Stop the washer and check the load. Make sure the load does not crest above the top edge of the drum.

Oversudsing of detergent.

- Oversudsing may create leaks, and may be caused by the type and amount of detergent used. High-Efficiency detergent is the only detergent recommended. The normal amount of

detergent to use is 1/4 to 1/2 of the maximum amount recommended by the detergent manufacturer.

Water leaks every load

Hoses not installed correctly.

- See Connecting the Water Lines to reinstall hoses. Replace damaged hoses.

Washer will not drain water Kinked drain hose.

- Ensure that the drain hose is not kinked. Drain located improperly.
- Make sure that the drain hose is no more than 5 ft. (1.5 m) away from the washer.

Excessive sudsing

Too much detergent or incorrect detergent.

- HE detergents are formulated specifically for High-Efficiency washers and contain sudsreducing agents. Only use detergent with the High-Efficiency (HE) logo.

Washer will not turn on

Power cord is not properly plugged in.

- Make sure that the plug is plugged securely into a grounded, 3-prong, 120 VAC, 60 Hz outlet.

House fuse is blown, circuit breaker has tripped, or power outage has occurred.

- Reset circuit breaker or replace fuse. Do not increase fuse capacity. If the problem is a circuit overload, have it corrected by a qualified electrician.

Wash cycle time is longer than usual

The washer automatically adjusts the wash time for the amount of laundry, water pressure and other operating conditions.

- This is normal. The washer adjusts cycle time automatically to provide optimal results for the selected cycle. The time remaining shown in the display is only an estimate. Actual time may vary.

Bleach does not dispense

Bleach dispenser cover is not properly installed.

- Make sure that the bleach cover is properly installed and snapped into place before the beginning of the cycle.

Bleach dispenser is dirty or clogged.

- Lift out the bleach dispenser cover and clean out the reservoir. Lint and other foreign debris that collects inside the dispenser may prevent proper dispensing of the bleach.

Premature dispensing of bleach

Bleach dispenser filled for future load.

- You cannot store bleach in the dispenser for future use. The bleach will be dispensed every load.

Incomplete or no dispensing of detergent

Detergent compartments clogged from incorrect filling.

- Make sure that detergent and additives are put into the correct dispenser compartments. For all detergent types, always make sure that the dispenser drawer is fully closed before the start of the cycle.

Too much detergent used.

- Make sure that the suggested amount of detergent is used per the manufacturer's recommendations. You may also dilute the detergent with water to the maximum fill line on the compartment to avoid clogging. Use only HE (High-Efficiency) detergent.
- **NOTE:** Always use as little detergent as possible. High-Efficiency washers need very little detergent to achieve optimum results. Using too much detergent will cause poor wash and rinse performance and may contribute to odors in washer.

Insufficient water supply.

- Make sure that both hot and cold water faucets are turned on all the way.

Normal residue.

- It is normal for a small amount of detergent to remain in the dispenser. If this residue builds up it can interfere with normal dispensing of products. Refer to the cleaning instructions.

Washer will not operate

Control panel has powered off due to inactivity.

- This is normal. Press the Power button to turn the washer on.

Washer is unplugged.

- Make sure cord is plugged securely into a working outlet.

Water supply is turned off.

- Turn both hot and cold faucets fully on.

Controls are not set properly.

- Make sure the cycle was set correctly, close the lid and press the Start/Pause button.

Lid is open.

- The washer will not operate if the lid is open. Close the lid and make sure that nothing is caught under the lid preventing it from closing completely.

Circuit breaker/fuse is tripped/ blown.

- Check house circuit breakers/fuses. Replace fuses or reset breaker. The washer should be on a dedicated branch circuit.

Control needs to be reset.

- Press the Power button, then re-select the desired cycle and press the Start/Pause button.

Start/Pause was not pressed after a cycle was set.

- Press the Power button then re-select the desired cycle and press the Start/Pause button. The washer will shut off if the Start/Pause button is not pressed within 60 minutes.

Extremely low water pressure.

- Check another faucet in the house to make sure that household water pressure is adequate.

Washer is too cold.

- If the washer has been exposed to temperatures below freezing for an extended period of time, allow it to warm up before pressing the Power button.
- Otherwise, the display will not come on.

Washer not filling properly

Filter clogged.

- Make sure the inlet filters on the fill valves are not clogged. Refer to the filter cleaning instructions.

Inlet hoses may be kinked.

- Check that inlet hoses are not kinked or clogged.

Energy efficiency.

- This is an High-Efficiency (HE) washer. As a result, the water level settings for this washer may be different than for conventional washers.

Insufficient water supply.

- Make sure that both hot and cold water faucets are turned on all the way.

The washer lid is open.

- The washer will not operate if the lid is open. Close the lid and make sure that nothing is caught under the lid preventing it from closing completely

Water level is too low/ No water is visible in the drum

Energy efficiency

- This is an High-Efficiency (HE) washer. As a result, the water level settings for this washer may be different than on your previous washer. The water will not normally cover the clothes. The fill level is optimized for the wash motion to achieve the best wash performance.

Performance

Wrinkling

Washer not unloaded promptly.

- Always remove items from the washer as soon as the cycle is complete.

Washer overloaded.

- The washer can be fully loaded, but the drum should not be tightly packed with items. The lid of the washer should close easily.

Hot and cold water inlet hoses are reversed.

- Hot water rinse can set wrinkles in garments. Check the inlet hose connections.

Staining

Bleach or softener dispensed too soon.

- Dispenser compartment is overfilled causing bleach or softener to dispense immediately. Always measure bleach to prevent overfilling one cup maximum. Dispenser drawer closed too quickly causing softener to dispense immediately.

Bleach or softener was added directly to the wash load in the drum.

- Always use the dispensers to ensure that laundry products are properly dispensed at the right time in the cycle.

Washer was not unloaded promptly.

- Always remove items from the washer as soon as possible after the cycle is complete.

Clothes were not properly sorted.

- Always wash dark colors separately from light colors and whites to prevent discoloration. Never wash heavily soiled items with lightly soiled items.

Poor stain removal

Proper options not selected.

- Heavier soils and tougher stains may require extra cleaning power. Select the Heavy feature to boost the cleaning power of the selected cycle.

Previously set stains.

- Articles that have previously been washed may have stains that have been set. These stains may be difficult to remove and may require hand washing or pre-treating to aid in stain removal.

Odor

Some odor is caused by the rubber attached to the washing machine.

- This odor is normal for new rubber and will disappear after the machine has been run a few times.

If the rubber door gasket and door seal area are not cleaned regularly, odors can occur from mold or foreign substances.

- Be sure to clean the gasket and door seal regularly and check under the door seal for small items when unloading the washer.

Odors can occur if foreign substances are left in the drainage pump filter.

- Be sure to clean the drainage pump filter regularly

Odors can occur if the drainage hose is not properly installed, causing siphoning (water flowing back inside the washing machine).

- When installing the drainage hose, be sure that it doesn't become kinked or blocked.

Using the dry function, odors can occur from lint and other laundry matter sticking to the heater. (Dryer model only)

- This is not a malfunction.

A particular odor can occur from drying wet clothes with hot air. (Dryer model only)

- The odor will disappear after a short while.

Wi-Fi

Trouble connecting appliance and smartphone to Wi-Fi network

The password for the Wi-Fi network was entered incorrectly.

- Delete your home Wi-Fi network and begin the registration process again.

Mobile data for your smartphone is turned on.

- Turn off the Mobile data on your smartphone before registering the appliance.

The wireless network name (SSID) is set incorrectly.

- The wireless network name (SSID) should be a combination of English letters and numbers. (Do not use special characters.)

The router frequency is not 2.4 GHz.

- Only a 2.4 GHz router frequency is supported. Set the wireless router to 2.4 GHz and connect the appliance to the wireless router. To check the router frequency, check with your Internet service provider or the router manufacturer.

The distance between the appliance and the router is too far.

- If the appliance is too far from the router, the signal may be weak and the connection may not be configured correctly. Move the router closer to the appliance or purchase and install a Wi-Fi repeater.

Error Codes

Washer fills with water slowly or not at all, or IE

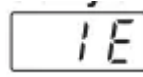

Water supply faucets are not fully open.

- Make sure that the water faucets are fully open.

Water line hoses are kinked, pinched, or crushed.

- Make sure that the hoses are not kinked or pinched. Be careful when moving the washer during cleaning and maintenance.

Water inlet filters are clogged.

- Clean the inlet filters. See the Maintenance section.

Water supply pressure to faucet or house is too low.

- Check another faucet in the house to make sure that household water pressure is adequate and flow is not restricted. Disconnect the inlet hose from the washer and run a few gallons of water through the hose to flush the water supply lines. If flow is too low, contact a plumber to have the water lines repaired.

Water supply connected with leaklimiting hoses.

- Hoses designed to limit leaks can trip falsely and prevent the washer from filling. The use of leaklimiting hoses is not recommended.



If the balance is not successful, this error will be displayed.

- The automatic attempt to rebalance the load was not successful. The cycle has been paused to allow the load to be manually adjusted.

The load is too small.

- Small loads may need additional items to be added to allow the washer to balance the loads.

Heavy articles are mixed with lighter items.

- The load may have heavy items loaded with lighter items. Always try to wash articles of somewhat similar weight to allow the washer to evenly distribute the weight of the load for spinning.

The load is out of balance.

- Manually redistribute the load if articles have become tangled, preventing the automatic distribution from working properly.

The load contains pillows or cushions.

- Wash the covers only. Remove the stuffing from the pillows or cushions before washing the covers.

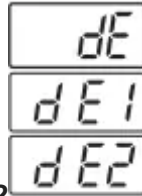

The tub does not rotate or dE, dE1, dE2

The door is not secured.

- Close and secure the door. If the message keeps appearing, unplug the power cord and call for service.



Water in the washer drains slowly or not at all and OE

Drain hose is kinked, pinched, or clogged

- Make sure the drain hose is free of clogs or kinks, and is not pinched behind or under the washer.

Drain discharge is more than 96 inches (2.4 m) above bottom of washer.

- The end of the drain hose should be no more than 96 inches (2.4 m) above the bottom of the washer.

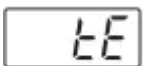

Control error.

- Unplug the washer and wait 60 seconds. Reconnect power and try again. If the error reappears, call for service.

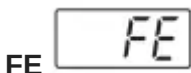

Water level is too high due to a faulty water valve.

- Close the water faucets, unplug the washer, and call for service.

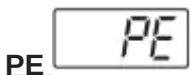

The water level sensor is not working correctly.

- Close the water faucets, unplug the washer, and call for service.

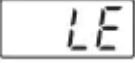
LE 

A motor error has occurred.

- Allow the washer to stand for 30 minutes and then restart the cycle. If the LE error code persists, call for service.

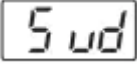
5 ud 

If the washing machine detects too many suds, it displays this error code and adds a Suds Reducing cycle. This adds about 2 hours to the cycle time. If too many suds are detected during spinning, the washing machine stops to help prevent leaking.

- Do not add more than the manufacturer's recommended amount of detergent. To remove suds, turn the washer off and on, then run the Rinse+Spin cycle.

PE 

The water level too low or high compared to the size of the load.

- The water level sensor is not working correctly. Unplug the power cord and call for service.

FE 

Inlet hose, drain hose or drain pump frozen.

- See the Care in Cold Climates section for instructions.

CL 

Control Lock is activated.

- This is not an error code. This code indicates that the Control Lock is activated. Press and hold Control Lock for 3 seconds.

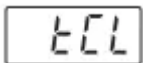

Tub Clean is activated or the washer drum needs cleaning.

- This is not an error code. This code indicates that the Tub Clean is activated or needed. Use the Tub Clean cycle to clean the washer drum.

Warning

This content is compiled from multiple sources and is provided for reference purposes only. It may not be complete or fully applicable to all situations. If you are unable to resolve your issue, please contact the product manufacturer or an authorized service provider for official support.

Document generated by [ManualsFile](#)

