

WHERE TO INSTALL THE TUMBLE DRYER

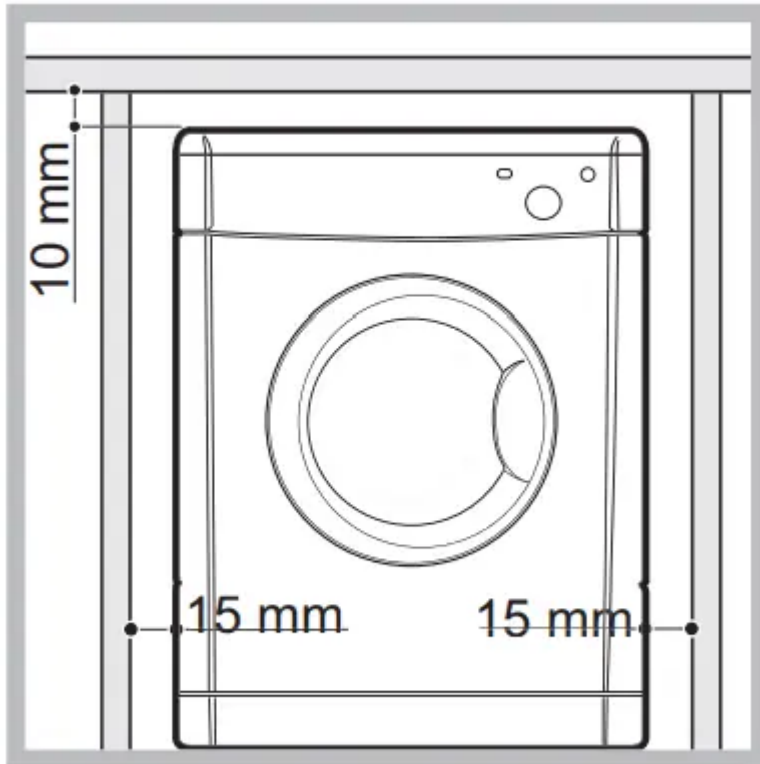

Install the dryer far from gas ranges, stoves, radiators or hobs as flames may damage it. If the dryer is installed below a worktop, ensure there are 10 mm between the upper panel of the dryer and any objects above it and 15 mm between the sides of the machine and the walls or furniture units adjacent to it. This ensures adequate air circulation. The appliance must be installed with the rear surface placed against a wall. ! We do not recommend that the dryer is installed in a cupboard but the dryer must never be installed behind a lockable door, a sliding door or a door with a hinge on the opposite side to that of the dryer door.

Priming the Water Collection System.

When your dryer is new, the water container will not collect water until the system is primed. This will take 1 or 2 drying cycles. Once primed it will collect water during every drying cycle.

WATER DRAINAGE CONNECTION

If the dryer is installed next to a drain the water can be plumbed into this drain. This does away with the need to empty the water container. The height of the drain must be less than 1m from the bottom of the dryer. Remove the existing hose from the dryer and connect it to the drain (if required add an additional length of hose).

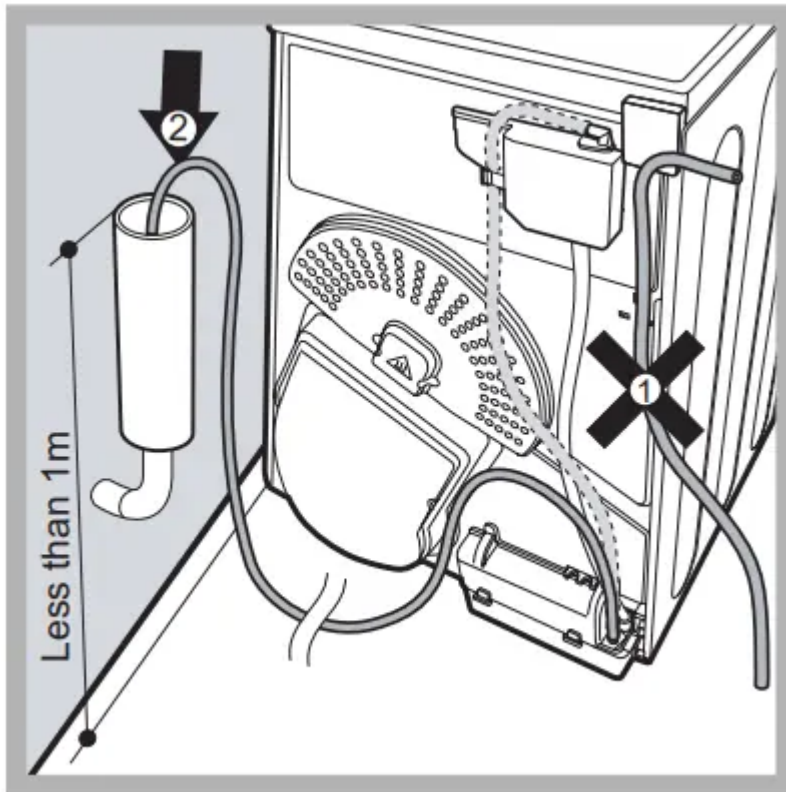

ELECTRICAL CONNECTIONS

The socket must be grounded.

The power cord must be regularly checked. If the supply cord is damaged it must be replaced by the manufacturer, its service agent or similarly qualified persons in order to avoid a hazard.

BEFORE YOU START USING YOUR DRYER

Once you have installed your dryer and before you use it clean the inside of the drum to remove any dust that could have accumulated during transport.

CONDENSER UNIT

You **MUST** clean the fluff from the condenser **EVERY** month. Failure to clean the condenser could cause premature failure of your dryer.

Remove the condenser unit regularly (at least monthly) and clean off any fluff deposits.

Step 1

Open the condenser cover.

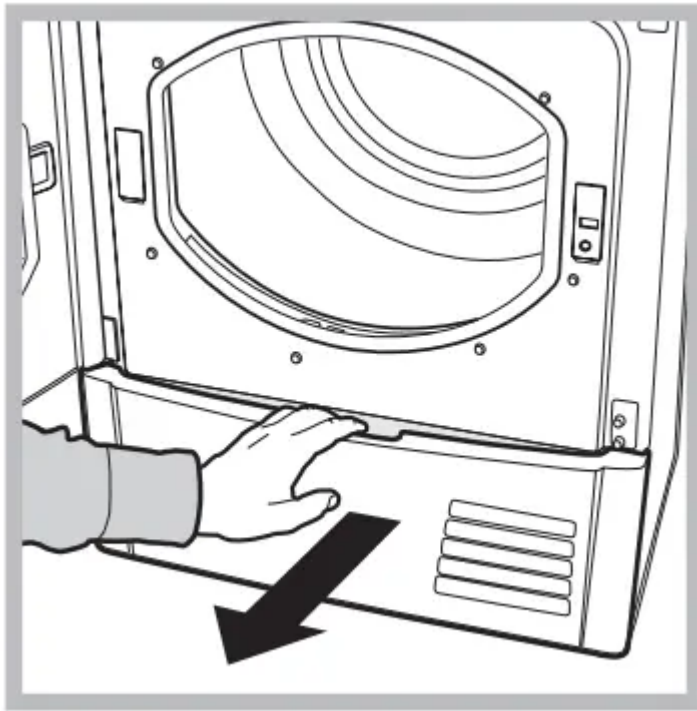

Step 2

Remove the condenser by turning the 3 catches and pulling the condenser towards you. It is normal for some residual water to be left in the condenser unit.

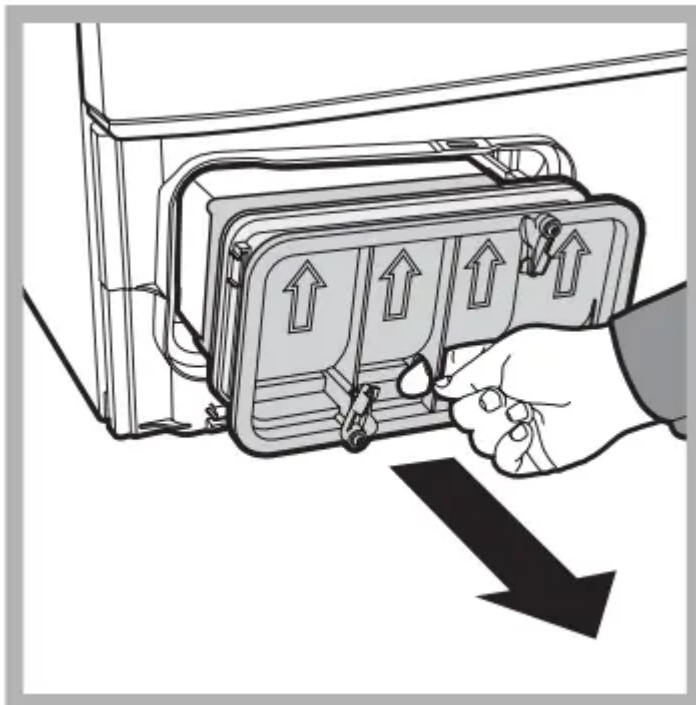

Step 3

Flush the condenser from the rear with water to remove any fluff deposits.

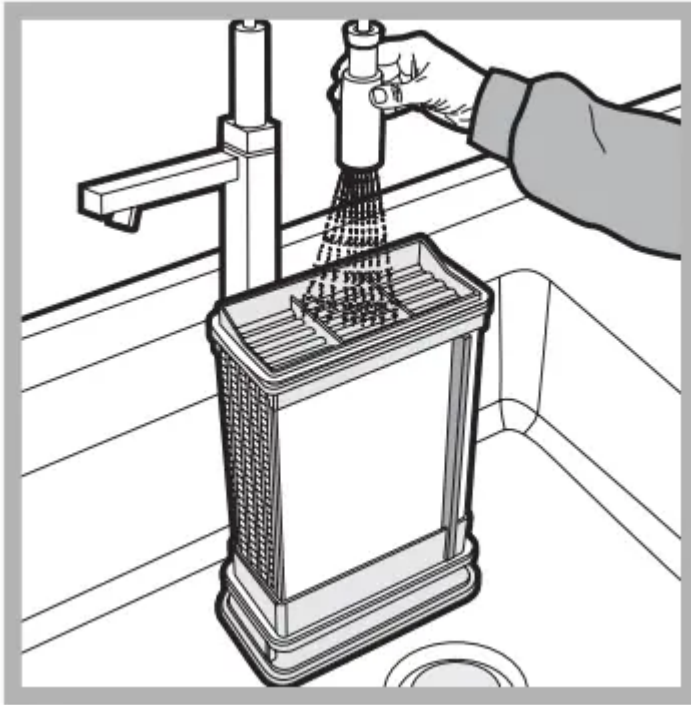

Step 4

Replace the condenser unit and make sure that all 3 catches are closed and that the position arrows on the front of the condenser are pointing upwards.

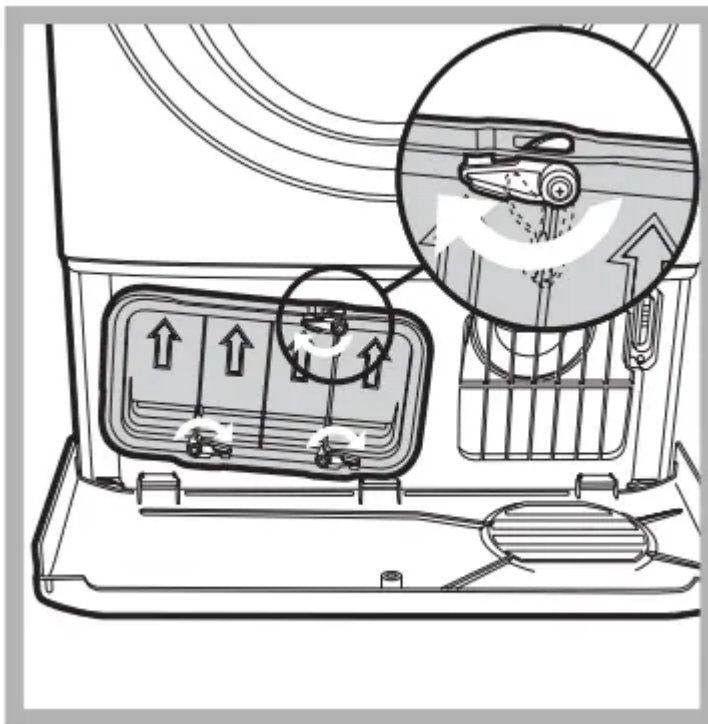

FLUFF FILTER

You must clean the fluff filter after EVERY drying cycle

Step 1

Open the door of your dryer.

Step 2

Pull out the filter (using the two finger grips).

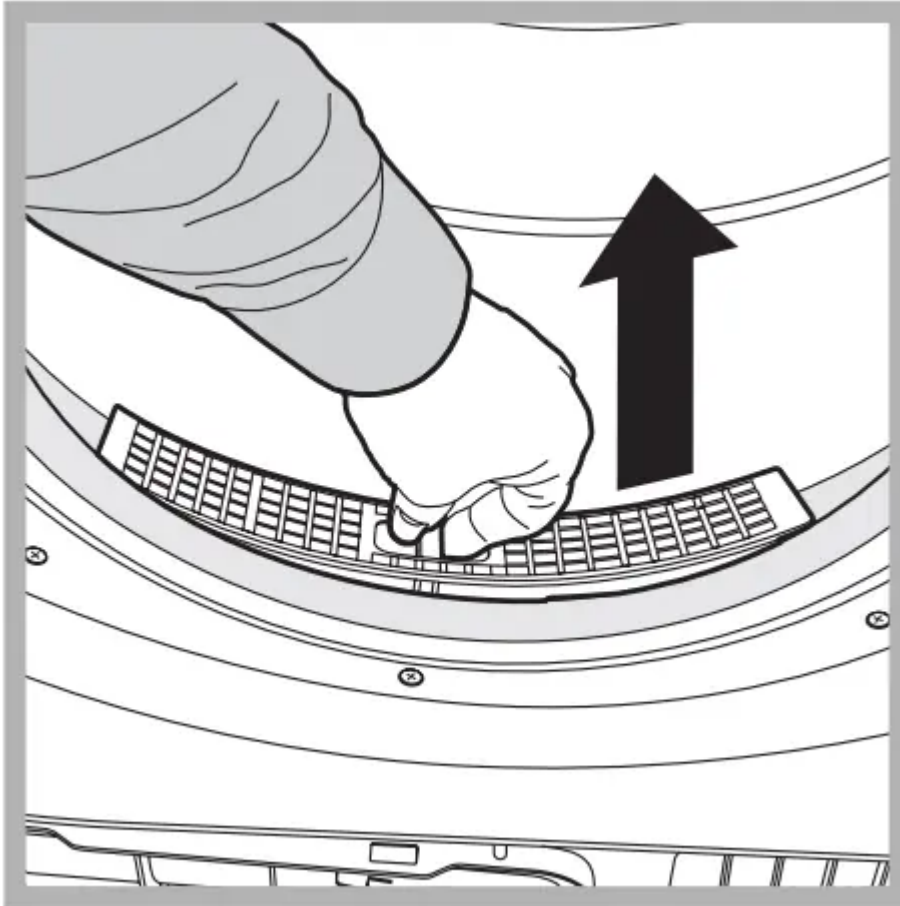

Step 3

Clean the fluff off the filter and replace it correctly.

Step 4

Make sure the filter is pushed fully home - NEVER run the dryer without the filter in position.

Failure to clean the filter after EVERY drying cycle will affect the drying performance of your machine.

It will take longer to dry and as a result will use more electricity during drying.

WATER CONTAINER

You MUST empty the water container after EVERY drying cycle. Removing the water container:

- **Step 1** Pull the water container towards you and remove it completely from the dryer.
- **Step 2** Empty all the water in the water container.

- **Step 3** Replace the water container making sure that it is securely fixed.

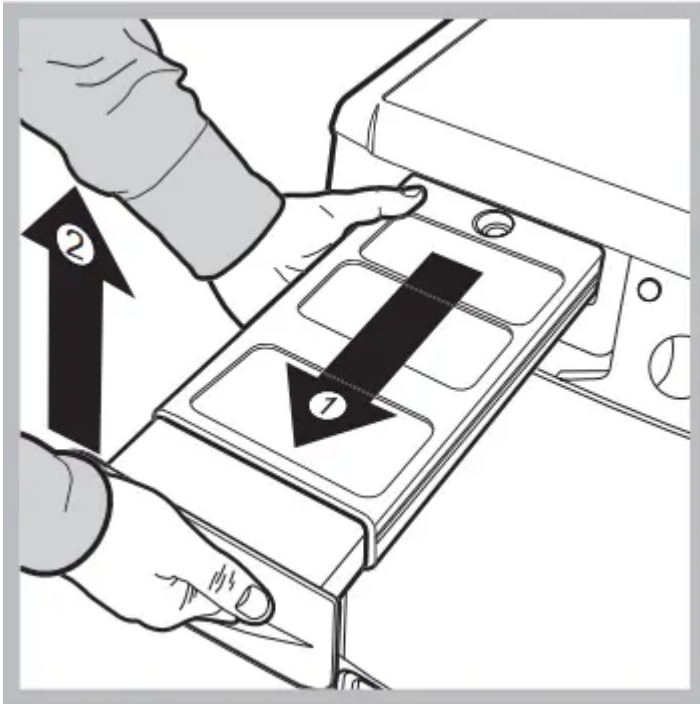

Failure to empty the water container will cause the machine to stop heating and the load may still be wet at the end of the drying cycle. The 'Empty Water' light will tell you that the water container needs to be emptied

Warnings

This appliance has been designed and built according to international safety standards. These warnings are given for safety reasons and must be followed carefully.

General safety

This appliance can be used by children aged from years and above and persons with reduced physical, sensory or mental capabilities or lack of experience and knowledge if they have been given supervision or instruction concerning use of the appliance in a safe way and understand the hazards involved.

This tumble dryer has been designed for home and not professional, use.

Do not touch the appliance while barefoot or with wet hands or feet.

Unplug the machine by pulling on the plug, not the cord.

After using the dryer, turn it off and unplug it. Keep the door closed to make sure that children do not use it as a toy.

Children should be supervised to ensure that they do not play with the dryer.

Cleaning and user maintenance shall not be made by children without supervision.

Children of less than 3 years should be kept away from the appliance unless continuously supervised.

The appliance must be installed correctly and have proper ventilation. The air intake at the front of the dryer should never be obstructed

Never use the dryer on carpeting where the pile height would prevent air from entering the dryer from the base.

Check to see if the dryer is empty before loading it. The back of the dryer could become very hot.

Never touch it while in use.

Do not use the dryer unless the filter, watercontainer and condenser are securely in place

Do not overload the dryer (see Laundry for maximum loads).

Do not load items that are dripping wet.

Carefully check all instructions on clothing labels

Do not tumble dry large, very bulky items.

Do not tumble dry acrylic fibres at high temperatures.

Do not turn off the dryer when there are still warm items inside.

Clean the filter after each use.

Empty the water container after each use.

Clean the condenser unit at regular intervals .

Do not allow lint to collect around the dryer.

Never climb on top of the dryer. It could result in damage.

Always follow electrical standards and requirements.

Always buy original spare parts and accessories.

To minimise the risk of fire in your tumble dryer, the following should be observed:

Tumble dry items only if they have been washed with detergent and water, rinsed and been through the spin cycle. It is a fire hazard to dry items that HAVE NOT been washed with water.

Do not dry garments that have been treated with chemical products.

Do not tumble dry items that have been spotted or soaked with vegetable or cooking oils, this constitutes a fire hazard. Oil-affected items can ignite spontaneously, especially when exposed to heat sources such as a tumble dryer. The items become warm, causing an oxidation reaction with the oil, Oxidisation creates heat. If the heat cannot escape, items

can become hot enough to catch fire. Piling, stacking or storing oil-affected items can prevent heat from escaping and so create a fire hazard. If it is unavoidable that fabrics containing vegetable or cooking oil or those that have been contaminated with hair care products be placed in a tumble dryer they should first be washed with extra detergent - this will reduce, but not eliminate the hazard. They should not be removed from the dryer and piled or stacked while hot.

Do not tumble dry items that have previously been cleaned in or washed in, soaked in or soiled with petrol/gasoline, dry cleaning solvents or other flammable or explosive substances.

Highly flammable substances commonly used in domestic environments including cooking oil, acetone, denatured alcohol, kerosene, spot removers, turpentine, waxes and wax removers.

Ensure these items have been washed in hot water with an extra amount of detergent before being dried in the tumble dryer.

Do not tumble dry items containing foam rubber (also known as latex foam), or similarly textured rubber like materials. Foam rubber materials can, when heated, produce fire by spontaneous combustion.

Fabric softener or similar products should not be used in a tumble dryer to eliminate the effects of static electricity unless the practice is specifically recommended by the manufacturer of the fabric softener product.

Do not tumble dry undergarments that contain metal reinforcements eg. bras with metal reinforcing wires. Damage to the tumble dryer can result if the metal reinforcements come loose during drying.

Do not tumble dry rubber, plastic articles such as shower caps or babies waterproof covers, polythene or paper.

Do not tumble dry rubber backed articles, clothes fitted with foam rubber pads, pillows, galoshes and rubber coated tennis shoes.

Remove all objects from pockets such as lighters and matches.

WARNING: Never stop the dryer before the end of the drying cycle unless all items are quickly removed and spread out so that the heat is dissipated.

Dryer Description

Control panel

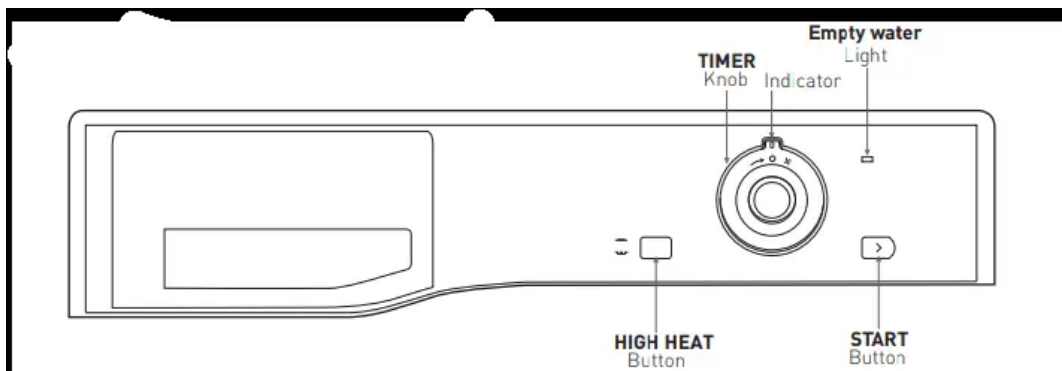

The HEAT button selects drying temperature.

OUT: LOW heat IN: HIGH heat.

The TIMER knob:: the 0 position swithes off the dryer.

The TIMER knob sets the drying time: rotate it clockwise, NEVER COUNTER-CLOCKWISE, until the indicator is pointing to the drying time you want to select.

The Empty Water indicator light signals that the water container is full and must be emptied. The light will take a few seconds to go out after replacing the empty water container, the dryer must be running for this to happen.

Note: If the water container fills up the indicator lights, the heat is turned off and your laundry will not dry.

CHOOSING A PROGRAMME

Standard Cotton - High (full) Heat This is the most efficient program in terms of energy consumption (EU 392/2012). To reach maximum efficiency, select the highest temperature option			
Drying times 800-1000rpm spin in washing machine			
1kg	2kg	3kg	4kg
30-40mins	40-55mins	55-70mins	70-80mins
5kg	6kg	7kg	8kg
80-90mins	95-120mins	120-140mins	130-150mins

Synthetics - Low (gentle) Heat		
Drying times on reduced spin in washing machine		
1kg	2kg	3kg
40-50mins	50-70mins	70-90mins

Acrylics - Low (gentle) Heat		
Drying times on reduced spin in washing machine		
1kg	2kg	
40-60mins	55-75mins	

1. Plug the dryer into the electrical socket.
2. Sort your laundry according to fabric type.
3. Open the door and make sure the filter is clean and in place.
4. Load the machine and make sure items are not in the way of the door seal. Close door.
5. Set the temperature with the HEAT button. High heat for Cotton. Low heat for delicates, synthetics and acrylics.
6. Select a drying time by rotating the TIMER knob clockwise. The tables below show APPROXIMATE drying times in minutes. Weights refer to dry garment weights.
7. Press the START button to begin. During the drying programme, you can check on your laundry and take out items that are dry while others continue drying. When you close the door again press the START button in order to resume drying.
8. About 10 minutes before the programme is completed it enters the final COOL TUMBLE phase (fabrics are cooled) which should always be allowed to complete.
9. Open the door and take the laundry out. Clean and replace the filter. Empty and replace the water container.
10. Unplug the dryer.

Laundry

MAX LOAD SIZE

Natural fibres: 8kg max Synthetic fibre: 3kg max

WASH CARE LABELS

Look at the labels on your garments when tumble drying. The following symbols are the most common.

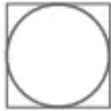
May be tumble dried 

Do NOT tumble dry 

Tumble dry at high heat setting 

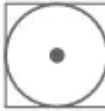
Tumble dry at low heat setting 

ITEMS NOT SUITABLE FOR TUMBLE DRYING

1. Articles that contain rubber or rubber-like materials or plastic film, any flammable articles or objects that contain flammable substances.
2. Glass fibres.
3. Items which have been dry cleaned.
4. Large bulky items (quilts, sleeping bags, etc). These expand when drying and prevent airflow through the dryer.

Troubleshooting

Before you call the service centre go through the following troubleshooting suggestions:

PROBLEM:

- The dryer won't start.

POSSIBLE CAUSES/SOLUTION:

- The plug is not in the socket or making contact.
- There has been a power failure.
- The fuse has blown. Try to plug another appliance into the socket.
- You are using an extension cord? Try to plug the dryer directly into the socket.
- The timer knob has not been set properly.
- The start button has not been pressed.
- The door is not closed securely.

PROBLEM:

- It is taking a long time to dry.

POSSIBLE CAUSES/SOLUTION:

- The filter has not been cleaned.
- The water container needs emptying? The empty water light is on?
- The condenser needs cleaning.
- The temperature setting is not correct.
- The correct time has not been selected.
- The air intake grill is obstructed.
- The items were too wet.
- The dryer was over loaded.

Warning

This content is compiled from multiple sources and is provided for reference purposes only. It may not be complete or fully applicable to all situations. If you are unable to resolve your issue, please contact the product manufacturer or an authorized service provider for official support.