

What comes in the carton

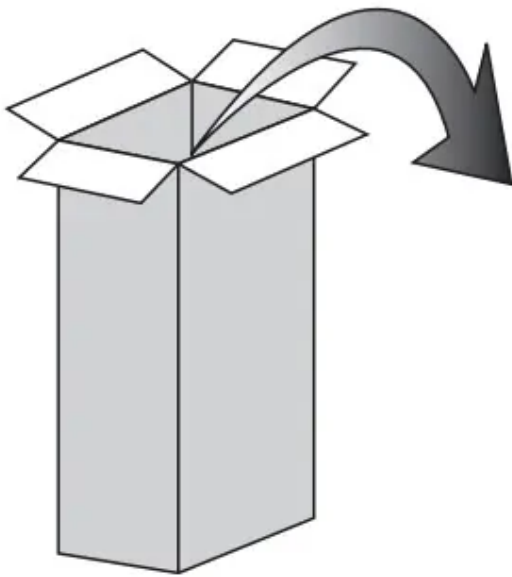

Important safeguards

Headlights on select models only (NEU186-NEU188)

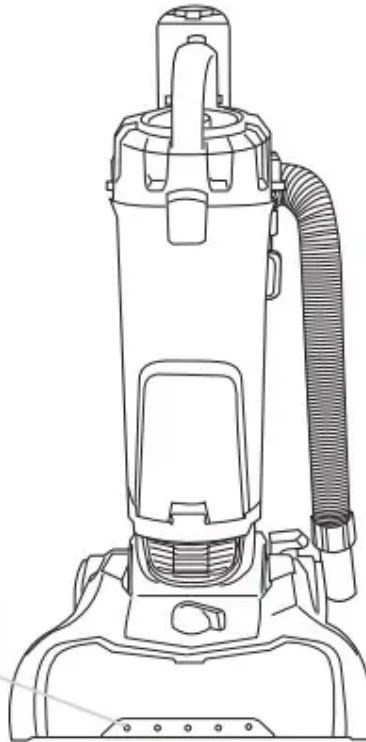

Vacuum cleaner



Dusting brush (NEU180-NEU187)



Upholstery tool (NEU180-NEU187)



Crevice tool (NEU180-NEU187)



Flexible telescoping crevice tool (NEU188)

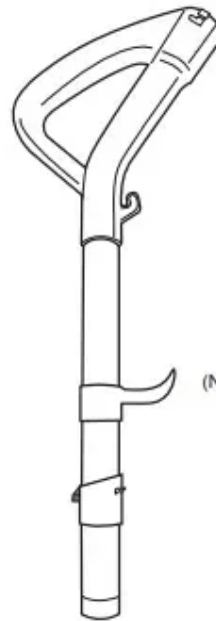

Handle

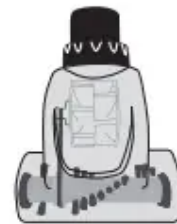

Turbo brush (NEU182-NEU188 except NEU182A)



2-in-1 upholstery tool (NEU188)



How to assemble your vacuum cleaner

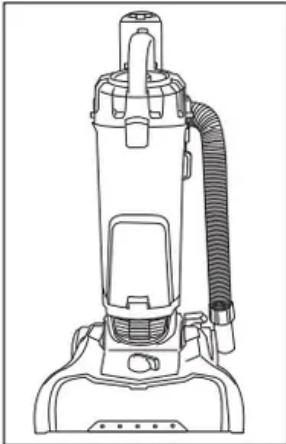

Vacuum cleaner with dust cup.

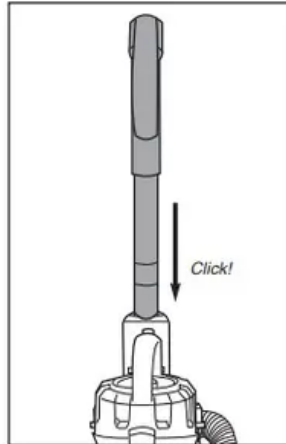

Slide handle into top of vacuum cleaner. Push down until it clicks.

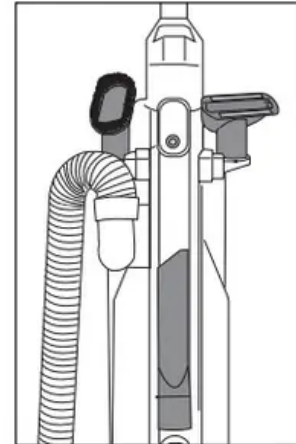

Store accessories on back of vacuum cleaner.

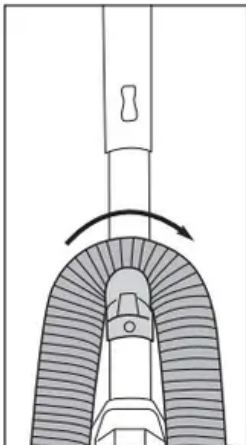

Loop hose over hose retainer.

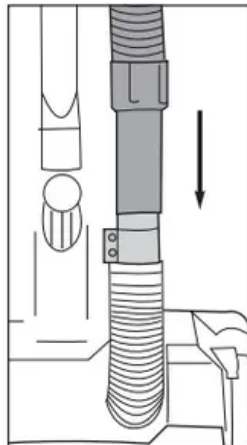

Push loose end of hose securely onto hose inlet.

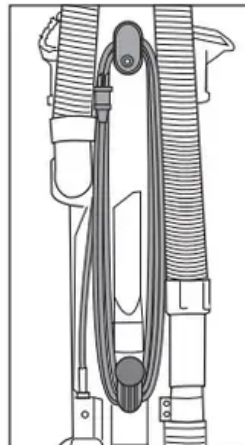

Wrap cord onto upper and lower cord wrap.

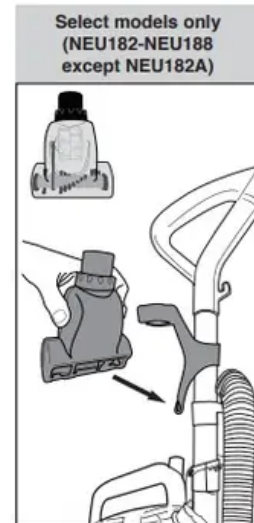

Store turbo brush on front of handle. Align brush opening with slot and push to snap tool into clip.

How to identify parts of your vacuum cleaner

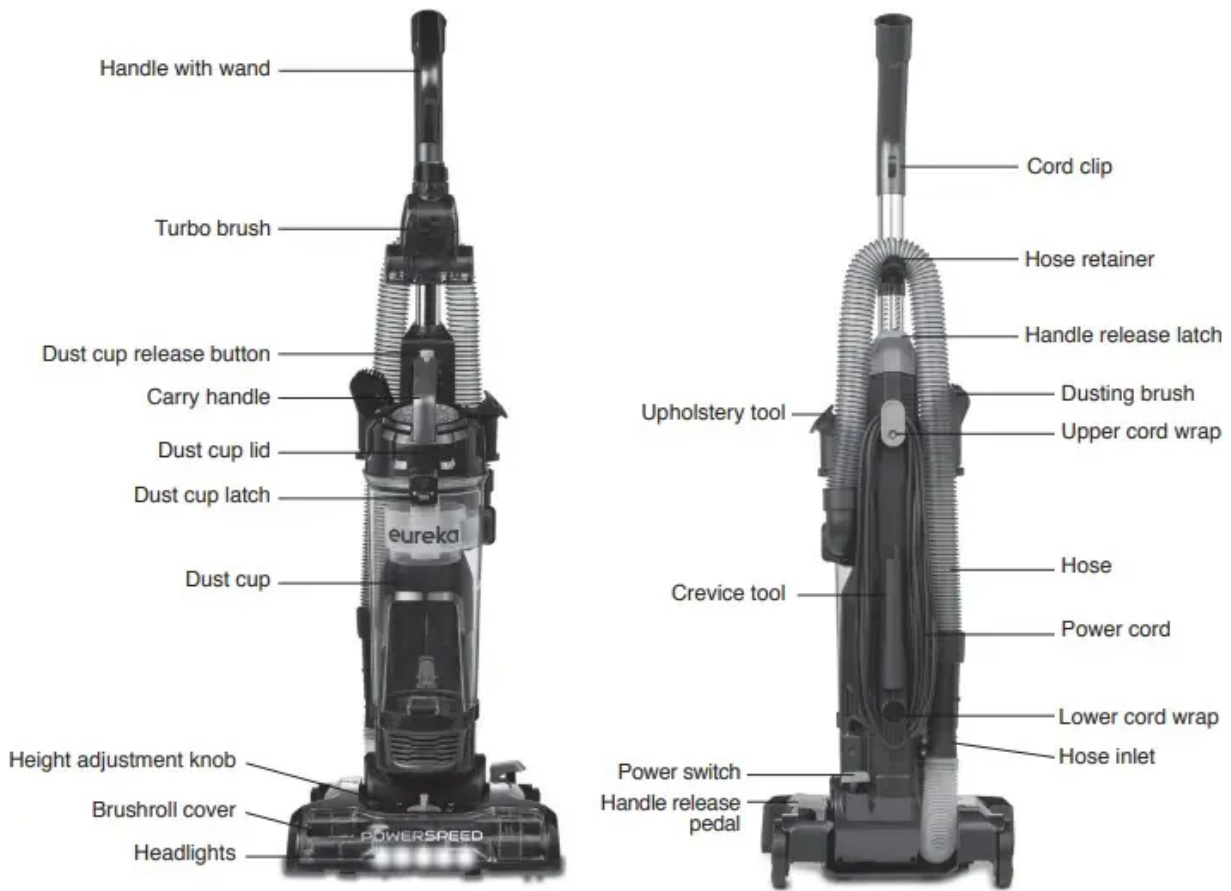

For filter maintenance instructions

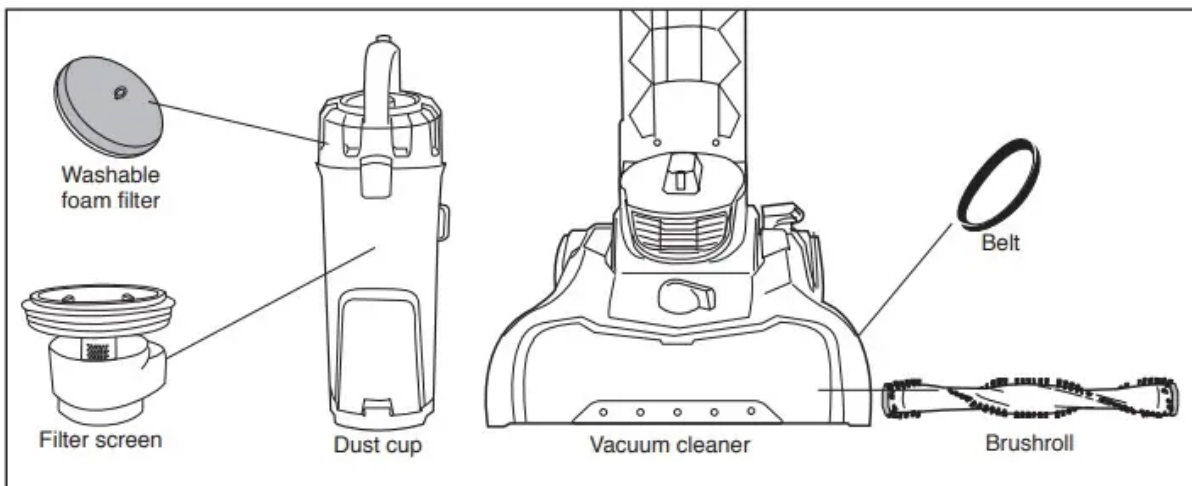

How to use your vacuum cleaner

1. Plug power cord into outlet.

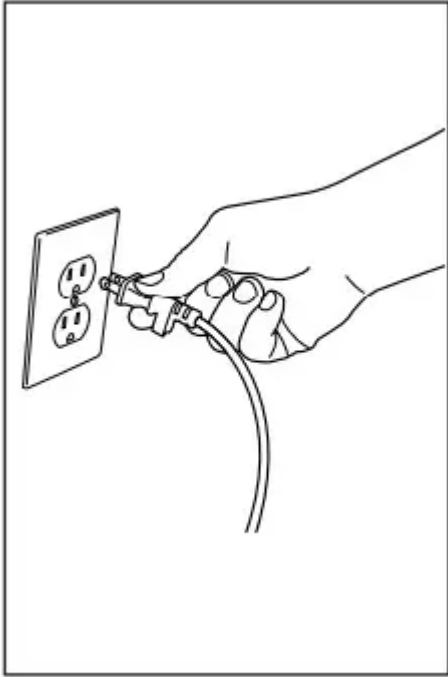

2. Turn height adjustment knob to adjust from bare floors to high pile carpet.

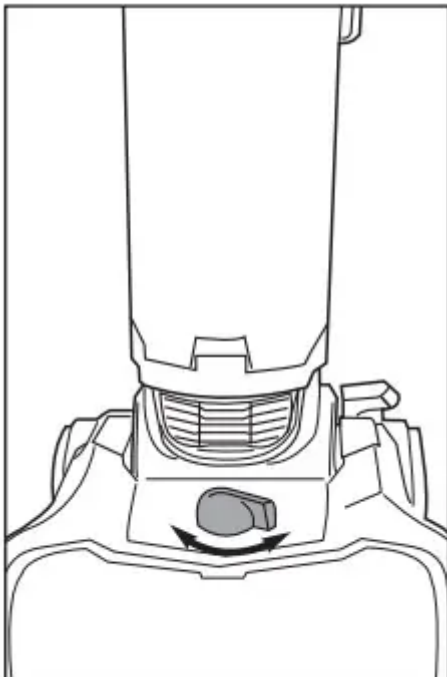

3. Step on power switch to turn vacuum cleaner on. Step on again to tum off.



4. Step on handle release to lower handle into position for vacuuming floors.

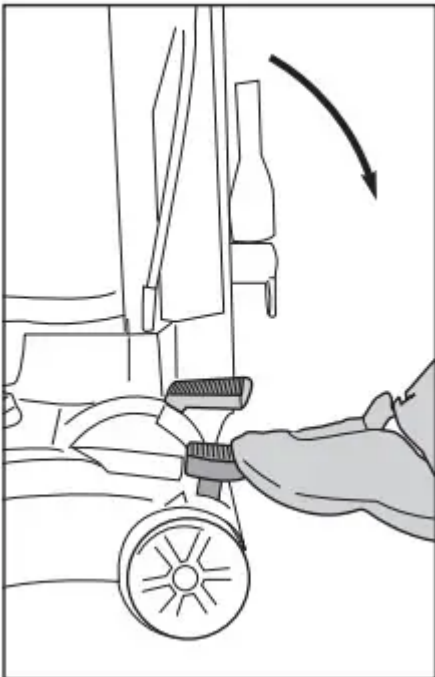

Empty dust cup after every use

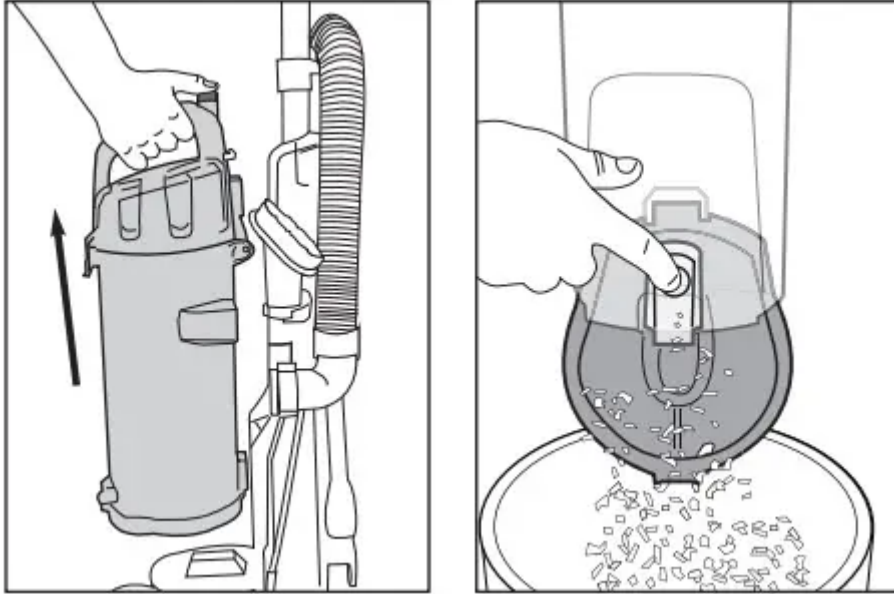

1. Press release button and lift off dust cup.
2. To empty debris, press lever to release bottom lid.

How to use accessories

CAUTION

When using tools, always place handle in upright position. Make sure vacuum cleaner is turned off while attaching tools.

Place vacuum in upright position.

Turn height adjustment knob to highest position.

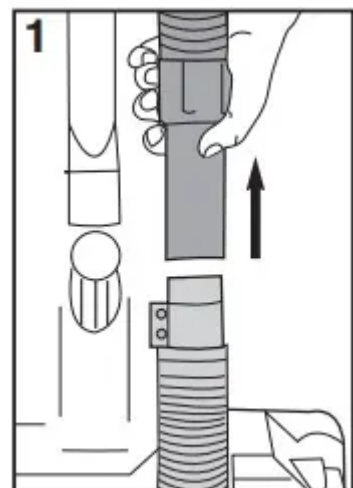

Pull up on hose connection to release hose end from hose inlet (1).

Push end of hose into top of handle and twist clockwise until it clicks (2).

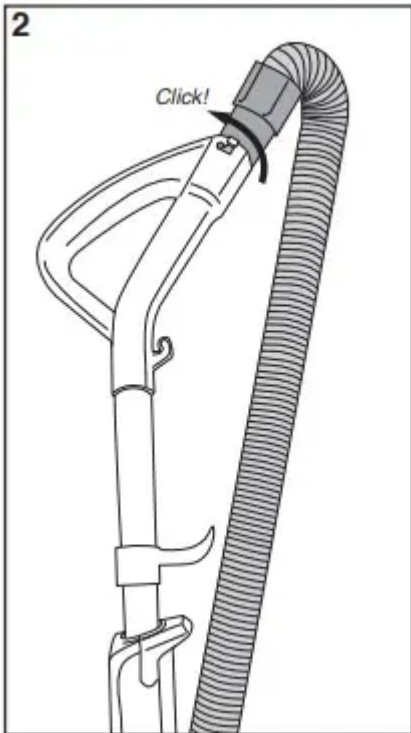

Press handle release latch and pull out handle with wand (3).

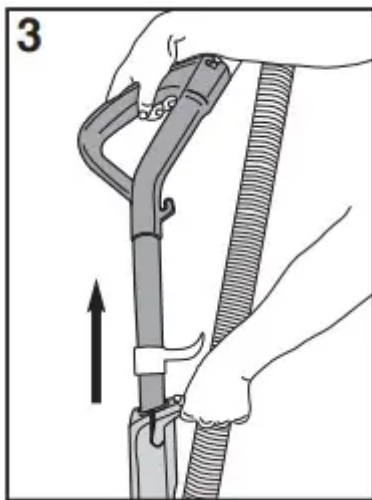

To attach accessories, push desired tool onto end of wand (4).

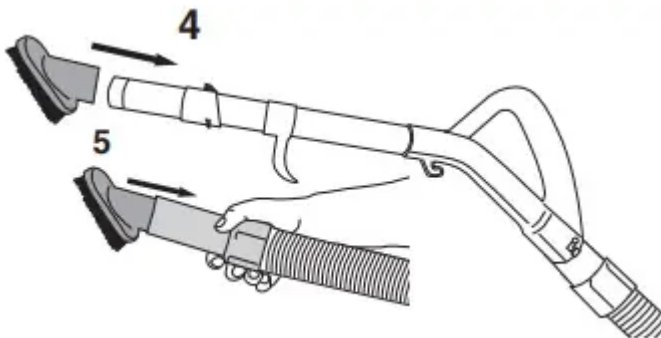

To use accessories without handle and wand, push desired tool directly onto end of hose (5)



When finished using accessories, twist hose counterclockwise and pull off handle. Slide handle into top of vacuum cleaner and push down until it clicks. Push loose end of hose securely onto hose inlet. Store tools on vacuum cleaner back.

How to maintain dust cup and filters

- **Dust cup – Empty after each use**

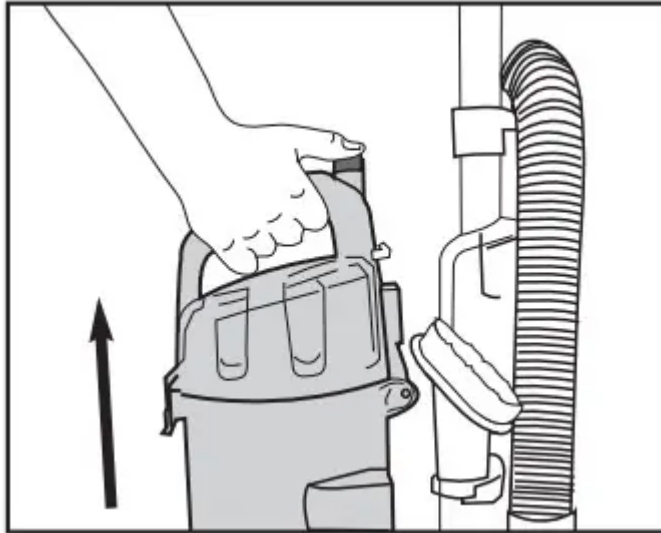

1. Press release button and lift off dust cup.



2. Hold dust cup over wastebasket and press lever to release bottom lid. Debris will empty.

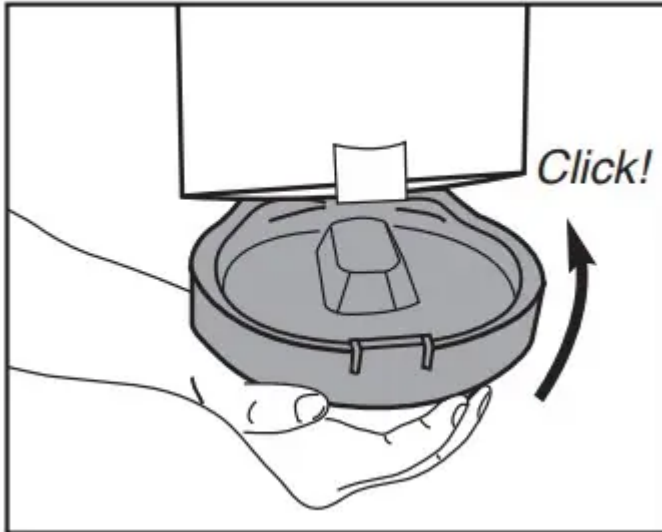

3. Close bottom lid until it clicks.

Washable dust cup filters - Clean monthly



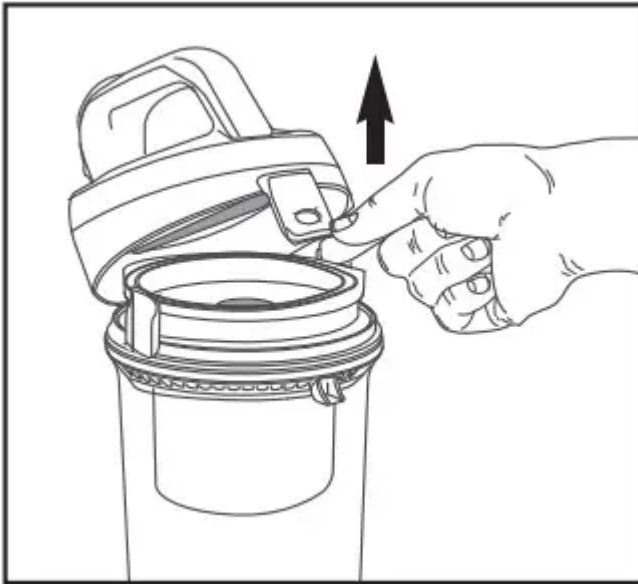

1. Pull dust cup latch to lift up dust cup lid.

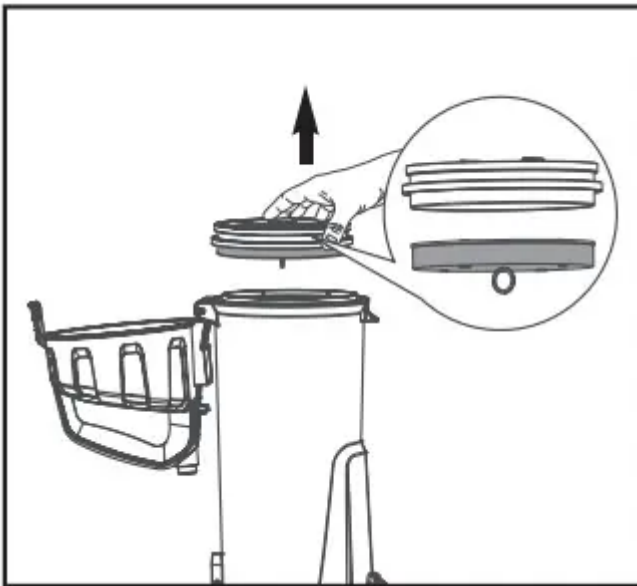

2. Lift out foam filter and shake off dust. Rinse foam filter and dry THOROUGHLY.

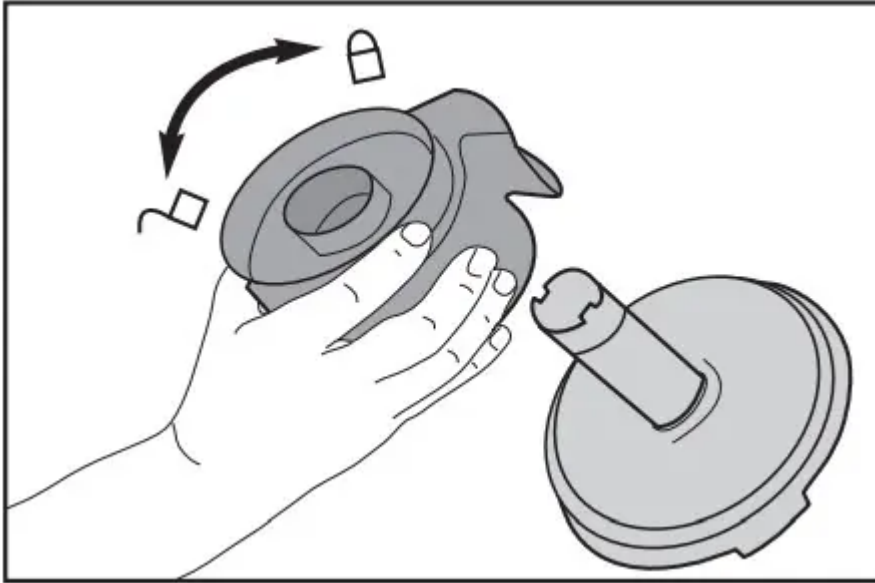

3. Grip tabs and lift out filter screen. Twist bottom of filter screen counterclockwise to unlock and pull apart. Shake off dust. Rinse screen and dust cup. Dry all THOROUGHLY. Reassemble screen; twist clockwise to lock.

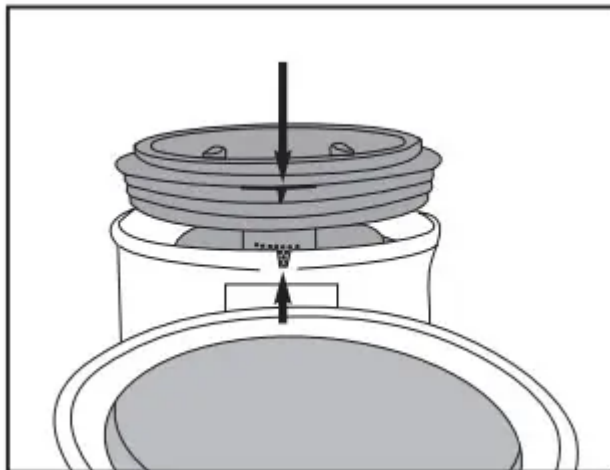

4. Align tab on filter screen with slot on back of dust cup and drop into position.

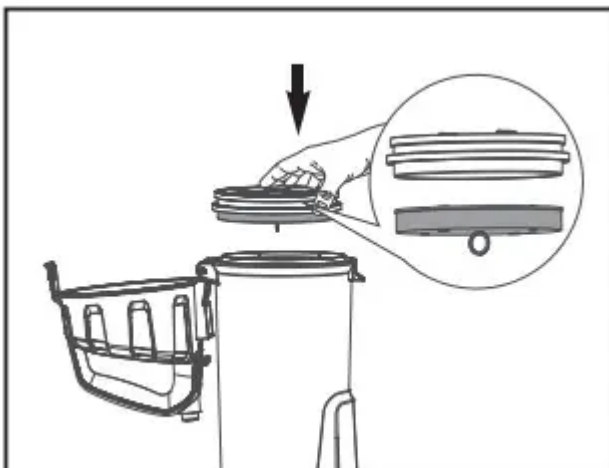

5. Reinstall foam filter.

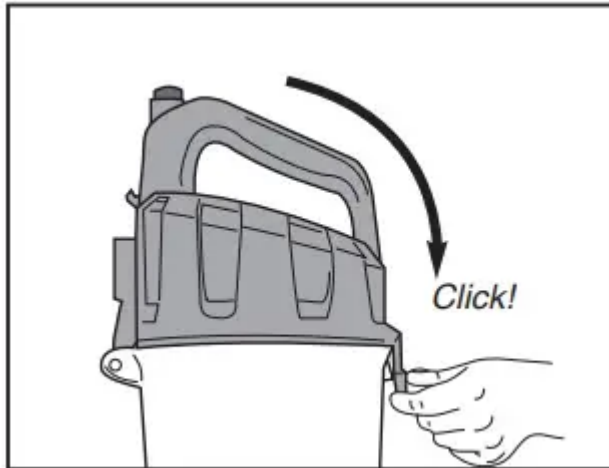

6. Close cover until it clicks.

Warning: Never operate vacuum cleaner without foam filter. filter screen and dust cup in proper position.

How to clear a blockage

CAUTION: Make sure vacuum is turned off and power cord is unplugged.

If vacuum is not cleaning floors. or if no suction at end of hose. check to be sure air path is not blocked.

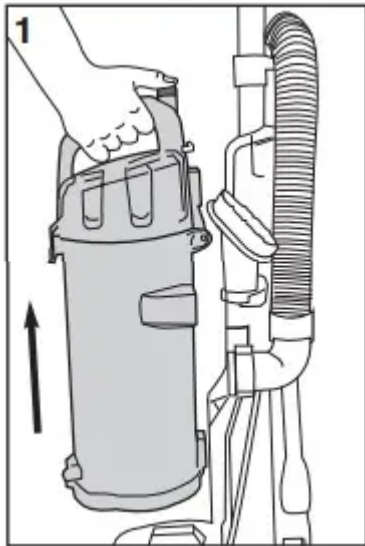

- Press release button and lift off dust cup (1).

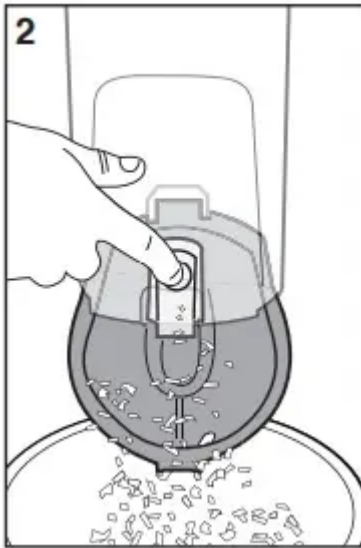

- Empty debris. Hold over wastebasket and press lever to release bottom lid (2).
- Check filter and filter screen.
- Remove any debris and shake off dust.

- Loosen end of hose.

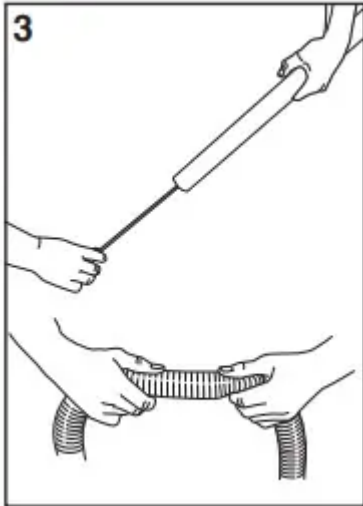

- Use a rod or similar blunt implement to ! clear a blockage in wand or hose. Flex hose to loosen debris (3). Use caution if there is any risk that glass or nails could have become imbedded in hose.

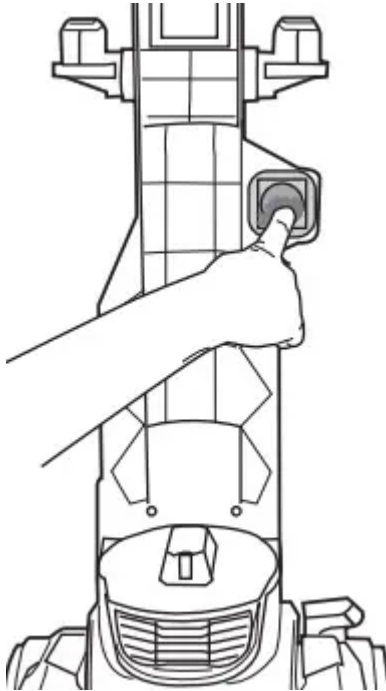

- Use finger to check for debris in air ge path (4).
- Reinstall filter and filter screen inside dust cup and position dust cup onto vacuum cleaner.

How to maintain brushroll

CAUTION: Make sure vacuum is turned off and power cord is unplugged.

- Step on handle release to lower handle.

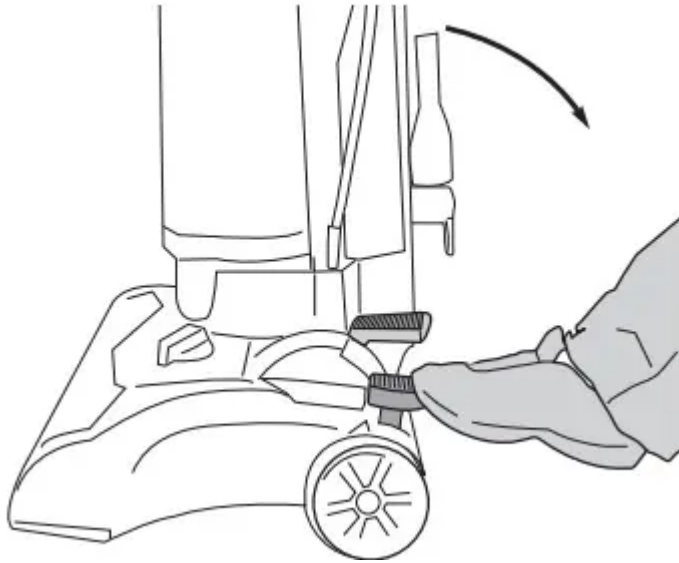

- Turn vacuum face down on floor.
- To avoid unnecessary service calls, check brushroll for debris.

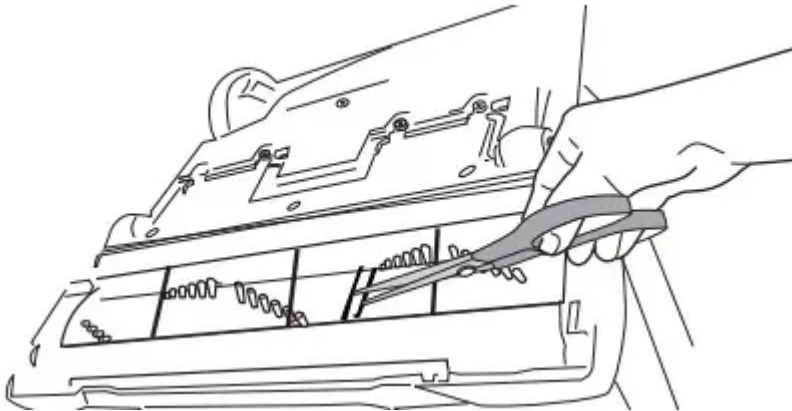

- Use scissors to clip heavy threads or strings.

How to maintain turbo brush

- Grasp collar and twist to unlock cover. Lift cover up.

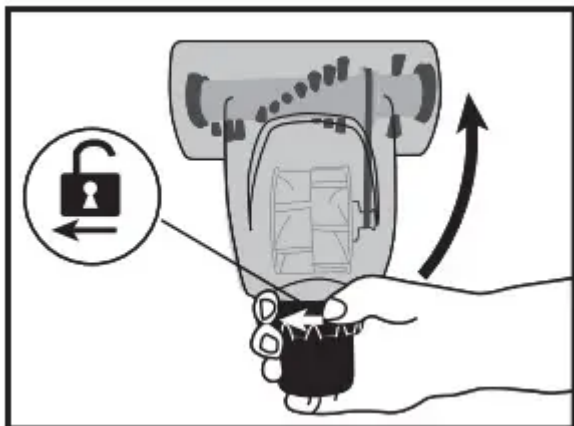

- With cover open, use fingers or small brush to clear accumulated pet hair from bristles.

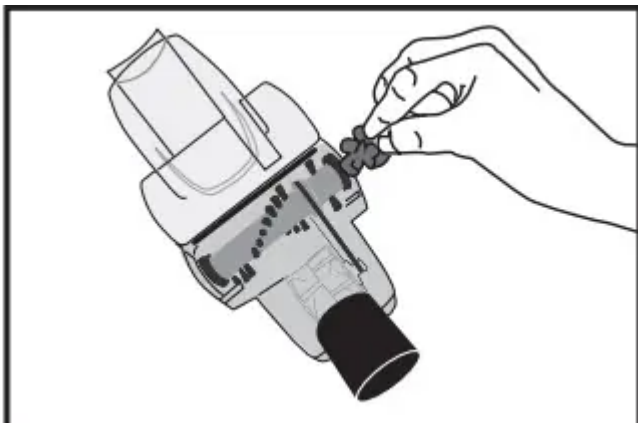

- Close cover and twist collar to lock.

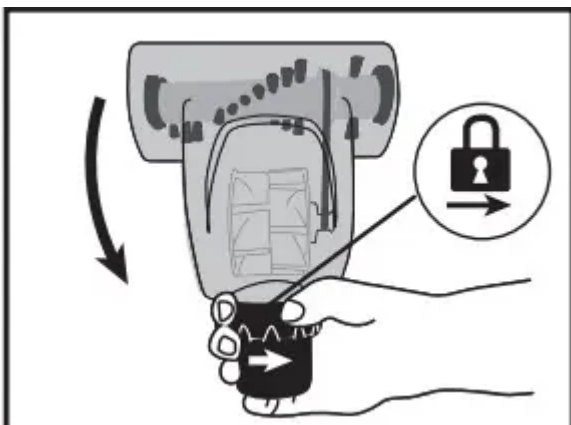

How to replace brushroll or belt

CAUTION: Make sure vacuum is turned off and power cord is unplugged.

- Step on handle release and lay vacuum cleaner face down.

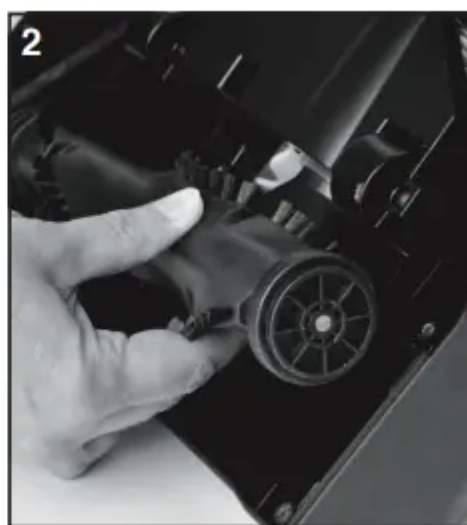

- Use Phillips screwdriver to remove 6 screws from brushroll cover (1). Lift off cover. Refer to Fig. 7 for location of screws.
- Rotate right end of brushroll and lift out (2)
- Lift out left end of brushroll.

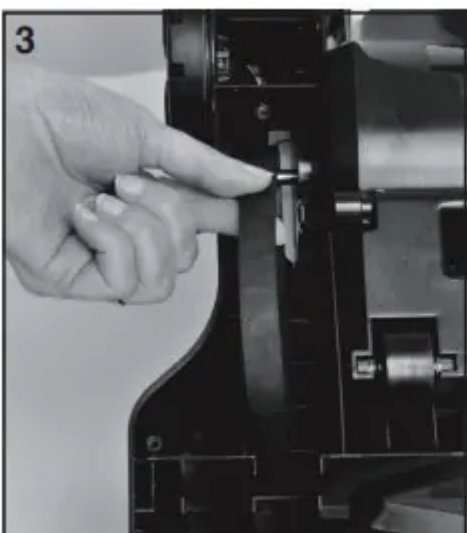

- To replace belt. position new belt around motor shaft (3)

- Loop new belt around brushroll shaft at left end of brushroll (4).



- To reposition brushroll into base. pull belt down and insert left end of brushroll first. Align brushroll end cap with slot so it fits into position (5). Press right end of brushroll into position.
- To replace brushroll cover. align slot on cover with tab (6) and snap cover into place. Replace 6 screws (7)

Thermal cut-off and problem solving

CAUTION: Make sure vacuum is turned off and power cord is unplugged.

Thermal cut-off

This vacuum cleaner has a special thermostat that protects the vacuum in case of motor overheating.

- If the vacuum suddenly shuts off. proceed as follows:
 1. Push the power switch to off and unplug the vacuum.
 2. Check the vacuum for a possible source of overheating such as a full dust cup, blocked hose or clogged filter. If these conditions are found. fix them and wait at least 30 minutes before attempting to use the vacuum.
 3. After the 30 minute period. plug the vacuum back in and tum on the switch. If the vacuum still does not work. call the Eureka

Customer Service HELPLINE at 1-800-282-2886.

Problem & Solution

- **Motor will not start.**
 - Push plug securely into outlet. try another outlet or check circuit breaker.
 - Step on power switch to turn vacuum on.
 - See detailed “thermal cut-off” instructions above.
- **Vacuum cleaner does not clean floors.**
 - Empty dust cup, clean and/or change filter.

- Clean or replace filter regularly to maintain suction.
- Check vacuum height adjustment knob position.
- Clean brushroll if needed.
- **No suction at the end of hose or wand.**
 - See other solutions above.
 - Remove clogs from the hose or wand that restrict the airflow.
- **Burning smell; brushroll will not turn.**
 - Check brushroll for debris.
 - Replace broken or out of shape belt.
- **Vacuum is hard to push.**
 - Adjust vacuum height knob to a higher position.
 - Check brushroll for debris and clean if needed.
- **Turbo brush will not turn (select models: NEU182-NEU188 except NEU182A).**
 - Check turbo brush for debris.

How to order replacement parts

Order genuine Eureka accessories and replacement parts

Visit www.eureka.com or call 1-800-282-2886



-Dusting brush tool - E0101 (all)

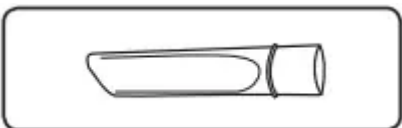

- Crevice tool - E0102 (all)

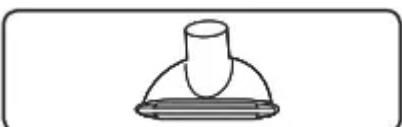

- Upholstery tool- E0201 (all)

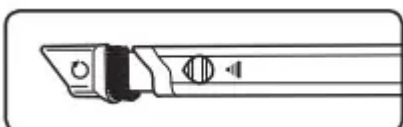

- Flexible telescoping crevice tool- S3006 (all)

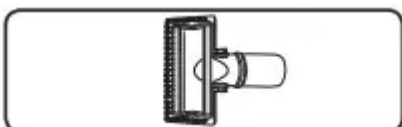

- 2-in-1 upholstery tool - S3007 (all)

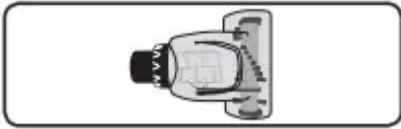

-Turbo brush- E0208 (all)

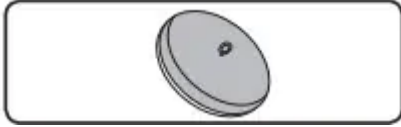

- Washable foam filter - E0202 (all)



- Brushroll -E0203B (all)

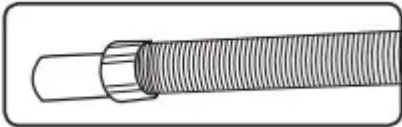

- Hose -E0204 (all)



- Belt -E0205 (all)

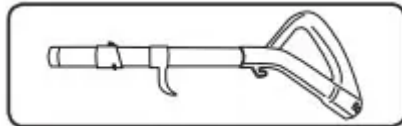

- Detachable handle - E0206A (NEU180, NEU180C) E0206B (NEU181, NEU182, NEU182CT) E0206C (NEU186) E0206D (NEU187, NEU188) E0206E (NEU188A) E0206F (NEU182A)

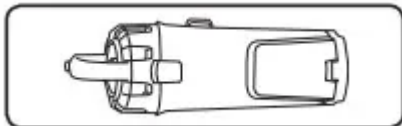

- Dust cup -E0207 (NEU180, NEU180C) E0207B (NEU181, NEU182, NEU182CT) E0207C (NEU186) E0207D (NEU187, NEU188)

Warning

This content is compiled from multiple sources and is provided for reference purposes only. It may not be complete or fully applicable to all situations. If you are unable to resolve your issue, please contact the product manufacturer or an authorized service provider for official support.