

## KNOW YOUR OMEGA



- A Hopper
- B Chute
- C Drum
- D Handle
- E Locking Clip
- F Housing
- G On/Off Button (In rear)
- H Auger (Inside Drum)
- I Adjustable End Cap
- J Juicing Screen (Inside Drum)
- K Celery Juice End Cap
- L Cleaning Brush

- M Pulp Container
- N Juice Container
- O Pusher

## QUICK START ASSEMBLY

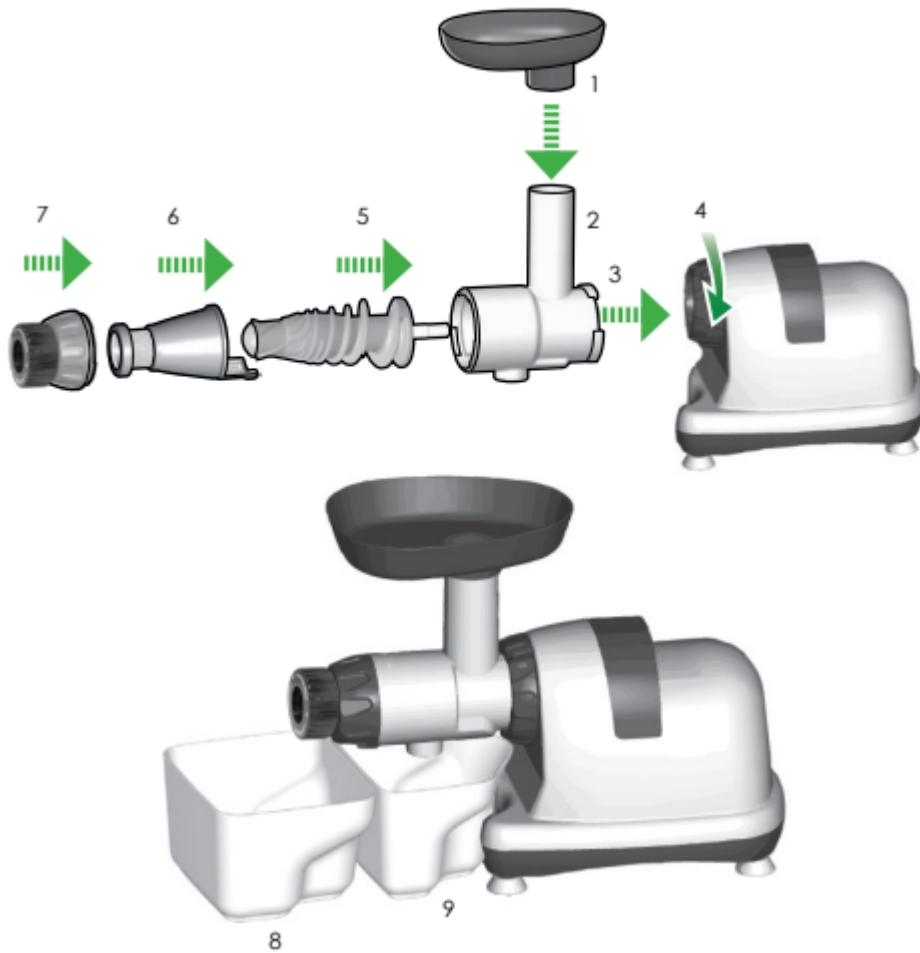

- 1 Hopper
- 2 Chute
- 3 Drum
- 4 Locking Clip
- 5 Auger
- 6 Juice Screen
- 7 Adjustable End Cap
- 8 Pulp Container
- 9 Juice Container

# OPERATING INSTRUCTIONS

## JUICING FUNCTION



Press [ON] button on the back of the Omega® Nutrition System to start.

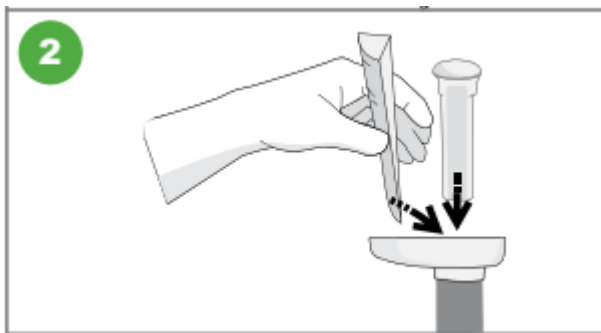

Gradually put the ingredients into the hopper chute and press down with the pusher.

DO NOT place any metal objects into the hopper. If the drum set is clogged or the machine stops operating, press the reverse button 2 to 3 times and press the ON button again to resume normal operation.

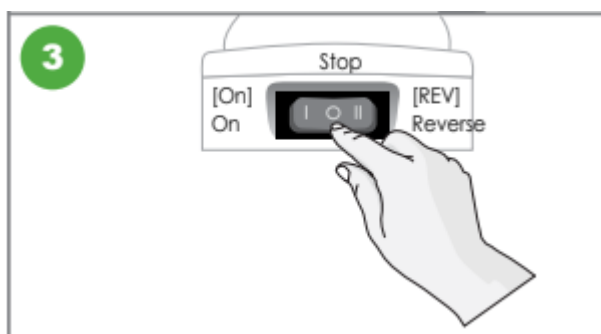

After the extraction or processing is complete, place the switch in the stop position to stop.

**WARNING** When using [ON] or [Rev] button, make sure that the auger stops completely.

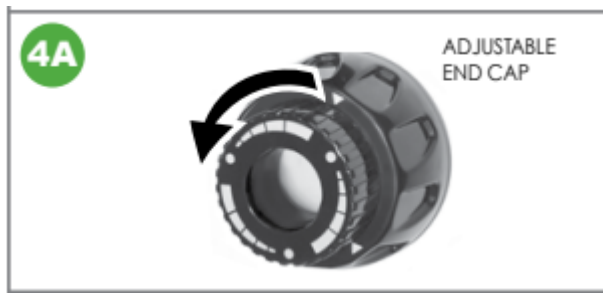

Turn the adjustable end cap counter clockwise to tighten the squeeze, increasing the pressure.  
Turn the adjustable end cap clockwise to loosen the pressure.

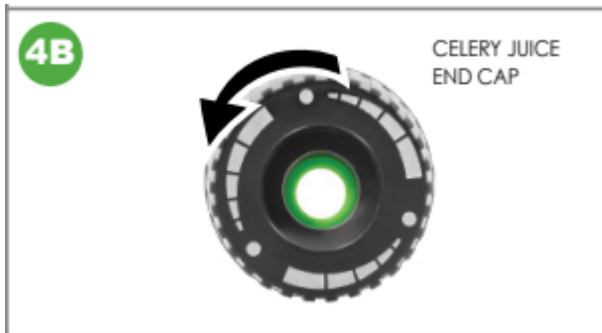

To yield more juice from Celery, Herbs, and Leafy Greens, use the adjustable end cap with the green inner ring. Turn the end cap counter clockwise to tighten the squeeze, increasing the pressure. Turn the end cap clockwise to loosen the pressure.

## OPERATING NOTES

This heavy-duty nutrition system features a patented, stone mill-like auger, made of hygienic U.S. FDA-approved melamine. The low speed of 80 RPMs ensures full taste and the highest nutritional value.

- **FRUIT JUICE.** Efficiently juices hard and soft fruits: even citrus fruits.
- **VEGETABLE JUICE.** Juices all kinds of vegetables including carrots, beets, celery, peppers, and radishes without destroying the natural flavor and nutritional benefits.
- Fresh taste and full nutrition are guaranteed with this unique extraction process.
- **WHEATGRASS AND LEAFY GREENS.** Kale, cabbage, spinach and pine tree needles are just some of the natural products that can be juiced. Enjoy the best that nature offers in raw foods and juice them for full nutritional benefits.
- **HERBS.** Celery is the most common of herbs that can be juiced. Extract liquid from raw celery stalks.

While you can juice fruits, vegetables, leafy greens and herbs to make one tasty drink, you may occasionally (or always) only juice one type to concentrate a fruit, vegetable or herb's health enhancing benefits.

## STERILIZATION & EASY CLEANING

### HANDWASH OPTION

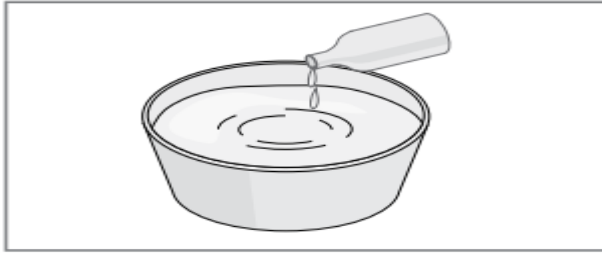

You can thoroughly wash parts by immersing in warm water diluted with one or two drops of baking soda or dishwashing soap for about 30 minutes.

### DISHWASHER SAFE OPTIONS

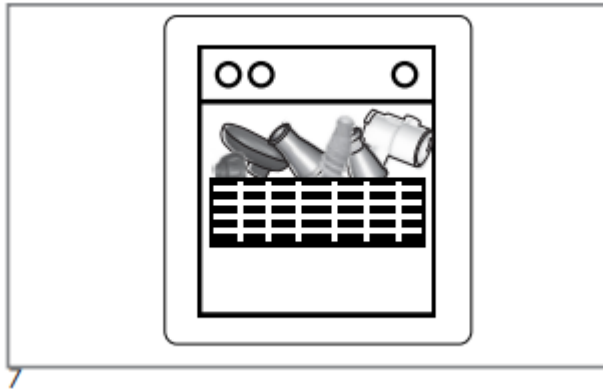



When finished using the Omega® Nutrition System, simply put parts into dishwasher, on top rack.







## PRECAUTIONS FOR SAFE USE







All users of this appliance must read and understand these safety precautions before operating.







## SIGN SAMPLES







|   |  |
|---|--|
|  | <p><b>This sign indicates contents that may cause risk of a fire or an electrical shock.</b></p> <p>Specific warnings are written in the sign.</p> |
|  | <p><b>This sign indicates prohibited acts.</b></p> <p>Specific prohibitions are written around or in the sign.</p>                                 |
|  | <p><b>This sign indicates contents of regulating or directing actions.</b></p> <p>Specific prohibitions are written around or in the sign.</p>     |

## PRECAUTIONS

|   |  |
|---|--|
|    | <p><b>CAUTION</b> Hazards or unsafe practices could result in minor personal injury or appliance damage.</p>   |
|    | <p><b>DO NOT PLUG IN OR UNPLUG WITH WET HANDS.</b></p> <p>It may cause an electric shock or an injury.</p>   |
|    | <p><b>DO NOT USE WITH OTHER THAN RATED VOLTAGE.</b></p> <p>It may cause an electric shock, a fire or abnormal performance. If the voltage is different, it may shorten the life of the motor or cause a failure.</p>   |
|    | <p><b>PLUG THE POWER CORD CORRECTLY AND PUSH IT TIGHT IN A WALL SOCKET.</b></p> <p>It may cause electric shock or a fire.</p>  |
|  | <p><b>IF THE SUPPLY CORD IS DAMAGED, IT MUST BE REPLACED BY THE MANUFACTURER, ITS SERVICE OR SIMILARLY QUALIFIED PERSONS IN ORDER TO AVOID A HAZARD.</b></p> <p>If the power cord is damaged, it may cause electric shock or a fire.</p>   |
|  | <p><b>NEVER ALTER THE APPLIANCE. ALSO, DO NOT DISASSEMBLE OR REPAIR BY YOURSELF. DO NOT INSERT FINGERS, FOREIGN SUBSTANCES OR OBJECTS SUCH AS PINS INTO GAPS OR HOLES IN THE BASE.</b></p> <p>It may cause a fire, an electric shock or a failure. For any technical support, contact the authorized local Customer Care Center.</p> |

|   |  |
|---|--|
|    | <p><b>DO NOT MOISTEN THE BASE OR SPLASH WATER ON THE BASE.</b></p> <p>Be careful not to let any liquids or other substances get into the switch on the appliance. <b>DO NOT OPERATE THE SWITCH WITH WET HANDS.</b> It may cause electric shock or a fire.</p>  |
|    | <p><b>WHEN THE POWER CORD, WIRE IS BROKEN OR DAMAGED OR THE PLUG-IN PART BECOMES LOOSE, DO NOT OPERATE IT.</b></p> <p>It may cause an electric shock, a fire or an injury.</p>   |
|    | <p><b>FOR SAFETY, MUST DO GROUND CONNECTION DO NOT DO THE GROUNDING ON GAS PIPE, PLASTIC WATER PIPE, TELEPHONE WIRE, ETC.</b></p> <p>It could cause an electric shock, a fire, or a malfunction and an explosion. Be sure to use the socket with ground connection.</p>  |
|  | <p><b>NEVER DISASSEMBLE BOWL SET DURING OPERATION OR INSERT FINGERS, FOREIGN OBJECTS SUCH AS FORKS, SPOONS ETC. INTO FEEDING TUBE OR JUICE OUTLET.</b></p> <p>It may cause an injury, an accident or a failure.</p>  |
|  | <p><b>THIS APPLIANCE IS NOT INTENDED FOR USE BY PERSONS (INCLUDING CHILDREN) WITH REDUCED PHYSICAL, SENSORY OR MENTAL CAPABILITIES, OR LACK OF EXPERIENCE AND KNOWLEDGE, UNLESS THEY HAVE BEEN GIVEN SUPERVISION OR INSTRUCTION CONCERNING USE OF THE APPLIANCE BY A PERSON RESPONSIBLE FOR THEIR SAFETY.</b></p> <p>Children should be supervised to ensure that they do not play with the appliance.</p> |
|  | <p><b>DO NOT OPERATE WITHOUT LOCKING THE HOPPER PROPERLY.</b></p> <p>It may cause an injury or a failure.</p>  |

|   |  |
|---|--|
|    | <p><b>IF A GAS LEAK IS DETECTED, DO NOT PLUG IN THE APPLIANCE'S POWER CORD INTO A POWER OUTLET. IMMEDIATELY VENTILATE THE ROOM BY OPENING A WINDOW, AND ALLOW TO FULLY VENTILATE BEFORE PLUGGING IN THE APPLIANCE.</b></p> <p>It may cause an injury or a failure.</p>   |
|    | <p><b>IF SCREW ROTATION IS STOPPED IN NORMAL OPERATION, PRESS [REVERSE/ REV] BUTTON AND HOLD FOR 2-3 SECONDS AND THEN AFTER REVERSE OPERATION IS COMPLETELY STOPPED, PRESS [ON] BUTTON AGAIN.</b></p> <p>If such a stop event continues during the operation, the parts may be damaged and performance may be deteriorated due to overheating in a motor. When the problem continues, immediately stop the appliance and contact the local Customer Care Center.</p> |
|  | <p><b>NEVER PUT A FINGER, A FORK OR A SPOON ETC. INTO JUICE OUTLET.</b></p> <p>It may cause an injury or a failure.</p>  |
|  | <p><b>DURING THE OPERATION, DO NOT ATTEMPT TO MOVE THE BASE, DISASSEMBLE THE BOWL SET OR PARTS AND TRY TO LOCK THEM.</b></p> <p>It may cause an injury or a failure. Any act of event needed, switch off first and unplug the power cord.</p>  |
|  | <p><b>WHEN USING THE APPLIANCE, BE CAREFUL FOR A NECKTIE, LONG NECKLACE, SCARF ETC. NOT TO BE ENTANGLED INTO FEEDING TUBE.</b></p> <p>It may cause an injury, a failure or a breakage.</p>   |
|  | <p><b>PLACE THE APPLIANCE ON A FLAT AND STABLE SURFACE.</b></p> <p>It may cause an injury or a failure.</p>  |

|   |  |
|---|--|
|    | <p><b>DO NOT OPERATE THE APPLIANCE FOR MORE THAN 30 MINUTES AT A TIME.</b></p> <p>It may cause a motor failure due to overheating. Cool it down sufficiently for 5 minutes and operate it again.</p>   |
|    | <p><b>WHEN PLACING INGREDIENTS INTO THE FEEDING TUBE, ONLY USE THE PUSHER PROVIDED.</b></p> <p>It may cause an injury or a failure.</p>  |
|    | <p><b>DO NOT ALLOW A SEVERE SHOCK TO THE APPLIANCE OR DROP IT.</b></p> <p>It may cause an electric shock, a fire or damage</p>   |
|   | <p><b>IF THE APPLIANCE GIVES OFF AN UNPLEASANT SMELL OR EXCESSIVE HEATING, SMOKE, STOP USING IMMEDIATELY AND CONTACT THE LOCAL CUSTOMER CARE CENTER.</b></p> <p>When using a new appliance, it gives off a smell and the smell disappears naturally over time.</p>         |
|  | <p><b>ALWAYS UNPLUG THE APPLIANCE AFTER USE.</b></p> <p><b>WHEN UNPLUGGING THE POWER CORD, MAKE SURE TO HOLD THE POWER CORD.</b></p> <p>If holding the wire to unplug, it may cause an electric shock or a fire.</p>   |
|  | <p><b>THE APPLIANCE WEIGHS ABOUT 20 LB (9 KG). WHEN MOVING THE APPLIANCE, ENSURE TO MOVE IT HOLDING GRIPS TIGHTLY AT THE BASE BOTTOM WITH BOTH HANDS.</b></p> <p>If attempting to hold bowl or the edge of the base, the base may fall causing an injury or a failure.</p> |

## IF THE AUGER STOPS WORKING

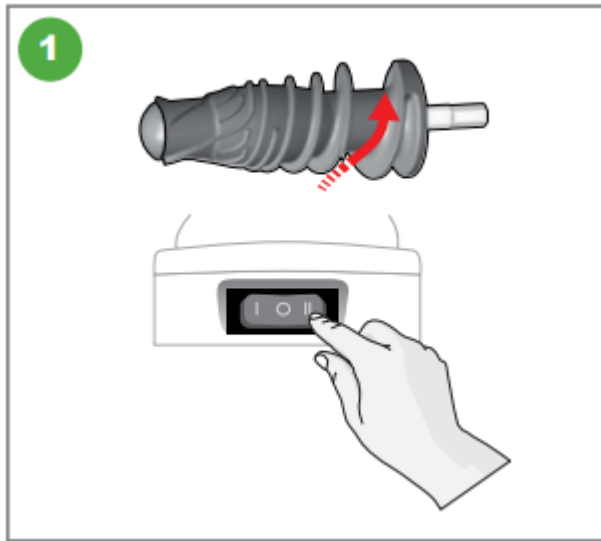

Press [Rev] button for 3 to 5 seconds, then release. When the [Rev] button is released, the auger will stop rotating. Repeat this 2 to 3 times. The [Rev] button pushes the ingredients upward releasing the food clog.

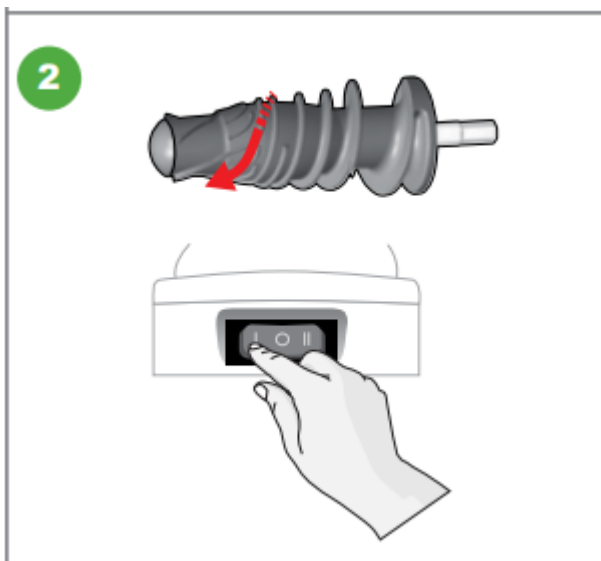

Press [ON] button to start. When using [ON] auger should rotate. Wait 2 to 3 seconds. Then press [REV] button. Repeat this 2 to 3 times. Make sure the auger stops completely after releasing the button.

### **Note:**

Even after following the directions above, if the juicer still doesn't work, please unplug the power cord, disassemble the chamber set and clean it. Then try again.

Any other servicing should be performed by an authorized service representative.

# HOW TO PREPARE

## FRUITS AND VEGETABLES

### Juicing Screen | Adjustable End Cap

- Thoroughly wash fresh ingredients to remove accumulated chemicals. The Omega® Nutrition System can extract juice from un-peeled fruits and vegetables but your taste may prefer peeled produce.
- Soft produce will process easier if refrigerated.
- Cut fruits and vegetables into small pieces to fit in the drum.
- Turn [ON] machine and let it run without interruption until all juice has been extracted.
- Alternate soft and firm items. It is best to start with the softer item.
- If the pulp starts to clog the drum, turn [OFF] machine and empty the drum set. Reassemble and resume normal operation.
- After placing the last piece of fruit or vegetable into the hopper, keep the machine running for a few seconds to ensure juice is extracted.
- After every use, clean all parts that come into contact with food or juice.
- You may juice items that are not usually used in meals, for example, carrot or beet stems.

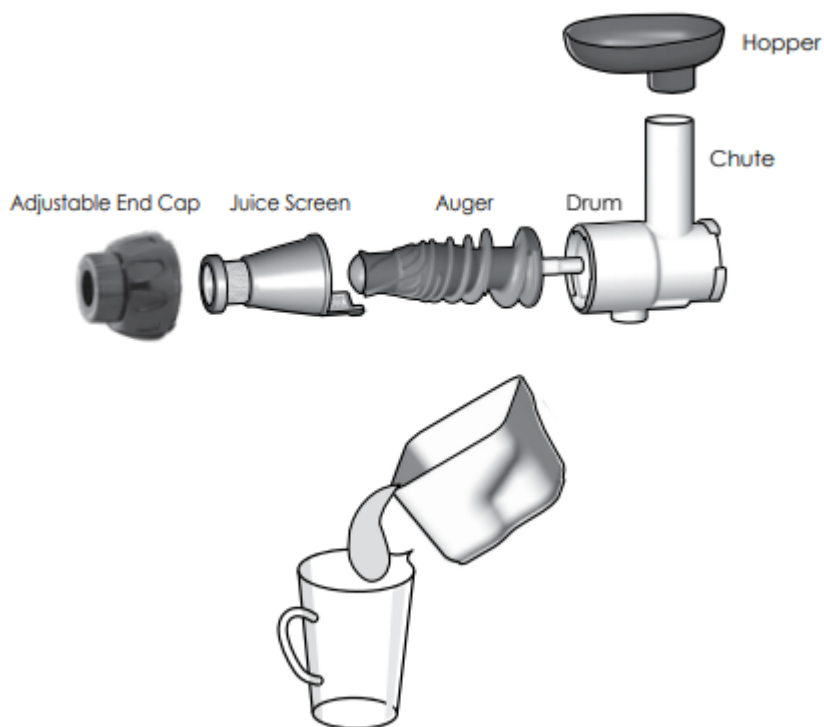

## WHEATGRASS AND GREENS

### Juicing Screen | Adjustable End Cap

- Thoroughly wash fresh ingredients to remove accumulated chemicals.
- Do not overfill the feed chute. Feed the juicer with small quantities. Allow most of the juice to exit before pushing in the next item.
- Some juice may exit into the pulp bowl and not the juice bowl. This is normal. This may continue to occur until the ejection area is filled with pulp.
- When juicing an item for added taste, insert that item during the first half of the juicing process. If inserted at the end of the process, the full taste may not come through.
- Certain green drinks may be too strong for some people. Lemon, apple, ginger, carrots &/or beets may be added as a natural sweetener to dilute the taste of wheatgrass and leafy greens.

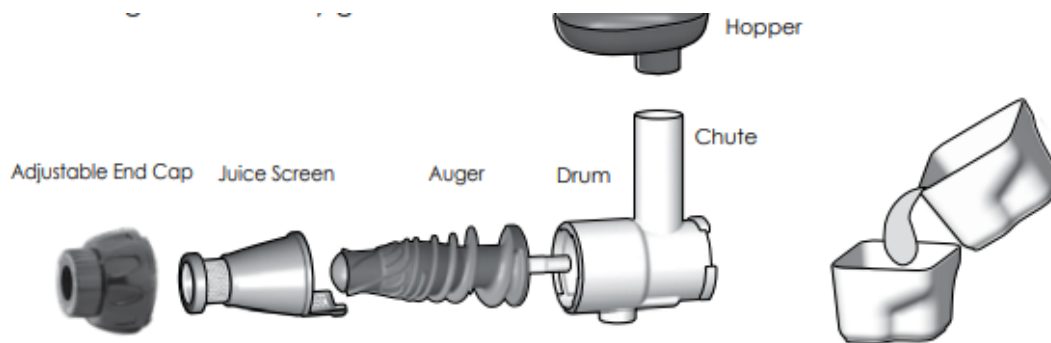

## HERBS (such as celery)

### Juicing Screen | Adjustable End Cap

- Thoroughly wash fresh ingredients to remove accumulated chemicals.
- Do not overfill the feed chute. Feed the juicer with small quantities. Allow most of the juice to exit before pushing in the next item.
- Some juice may exit into the pulp bowl and not the juice bowl. This is normal. This may continue to occur until the ejection area is filled with pulp.
- When juicing an item for added taste, insert that item during the first half of the juicing process. If inserted at the end of the process, the full taste may not come through.
- Certain green drinks may be too strong for some people. Lemon, apple, ginger, carrots &/or beets may be added as a natural sweetener to dilute the taste of wheatgrass and leafy greens.

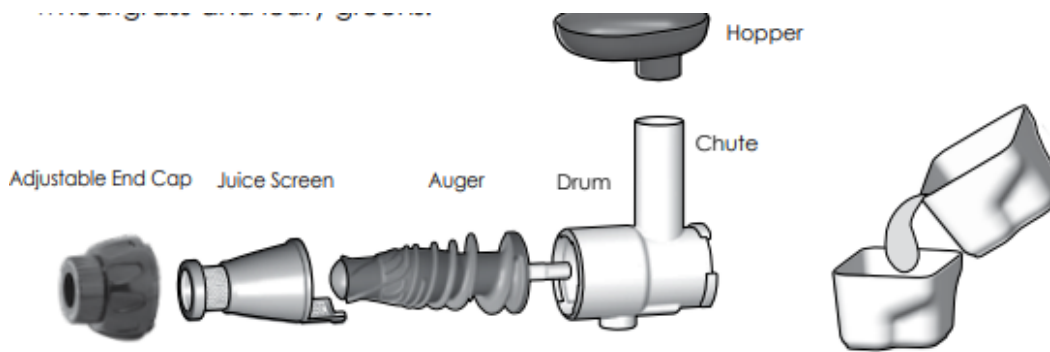

## TROUBLESHOOTING

Please troubleshoot using the details below before contacting Omega Customer Service for repair or service. When contacting Omega for after-sales service, please have the manufacturer's serial number or bar code available.

### The Appliance Does Not Work

- Make sure the power cord is plugged in correctly.
- Make sure the drum is assembled correctly. If the drum is not locked into place, the appliance will not operate.
- Make sure the appliance is assembled according to the instructions in this manual. Refer to the instructions.
- If the appliance still does not work, please contact Omega Customer Service for additional support.

### The Drum Does Not Open

- If there is a lot of pulp inside the drum, press [On] to release the excess pulp.
- Check the appliance for any foreign substance or solid objects including seeds.
- Press [Rev] button to push up stuck ingredients.
- Do not attempt to open by force. If the drum still does not open, please contact Omega Customer Service for additional support.

### The Appliance Stops During Normal Operation

- Check for large pieces of food stuck in the appliance.
- Refer to the section "If the Auger Stops Working" and follow the guideline for the [Rev] button.
- If the appliance still does not work, please contact Omega Customer Service for additional support.

### **Fine Lines or Scratch Marks around the Auger**

- This is normal. Do not be concerned. These are molding marks resulting from the normal manufacturing process.

### **Juice Leaks Over the Base**

- Check for an excessive amount of ingredients in the hopper and/or chute.
- If you try to juice a large amount of food compared to the pulp chute, the packing will be slightly pushed away. Juice may leak out of the gap.
- Do not force too much food into the juicer. Push food gradually for extraction.
- Check to make sure the juice flap is closed.

### **Juicer Shakes when In-Use**

- This is normal as the auger rotates. It is not a malfunction. Hard ingredients such as carrots, potato, radish, beets, etc. may cause shaking more so than soft ingredients.
- Depending on the firmness of the ingredient, there may be a more pronounced shaking of the motor.
- Slight shaking may be caused by the motor.

## **IMPORTANT SAFEGUARDS**

### **WARNING: GROUNDING INSTRUCTIONS**

This appliance must be grounded while in use to protect the operator from electrical shock. The appliance is equipped with a 3-conductor cord and a 3-prong grounding-type plug to fit the proper grounding-type receptacle. The appliance has a plug that looks like sketch A in Figure 73.1. An adaptor, sketch B, should be used for connecting sketch A plugs to twoprong receptacles. The grounding tab which extends from the adaptor must be connected to a permanent ground such as a properly grounded outlet box as shown in sketch C using a metal screw.

**FIGURE 73.1**  
**Grounding Methods**

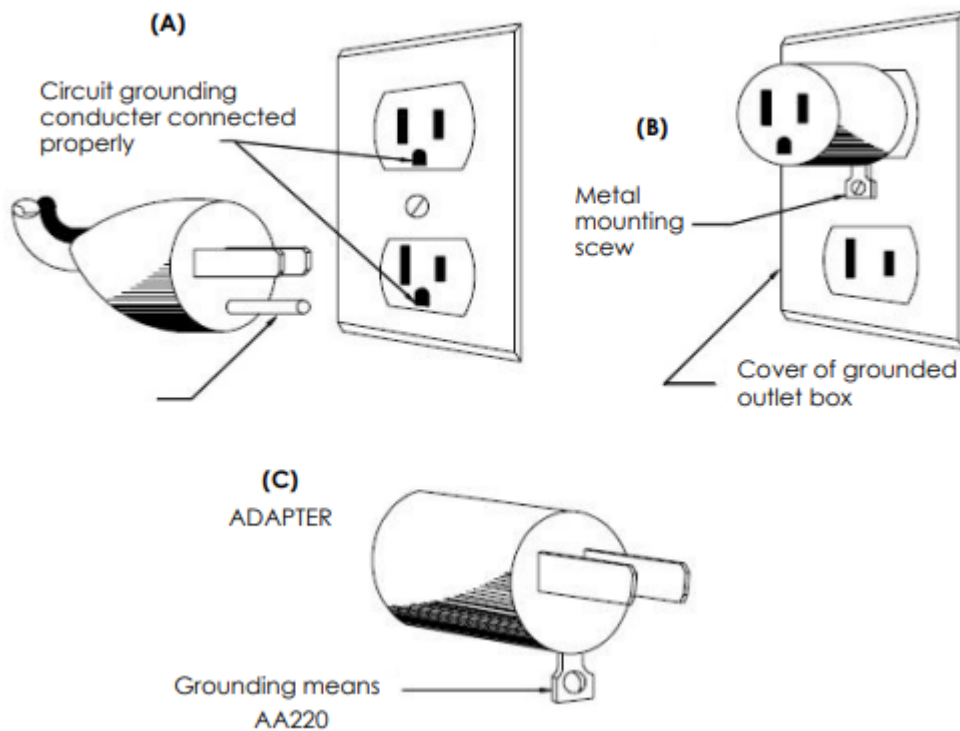

When using electrical appliances, basic safety precautions should always be followed including the following.

1. READ ALL INSTRUCTIONS BEFORE USING.
2. To protect against electrical shock, do not immerse cord, plug, or main body (motor) in water or other liquid.
3. Close supervision is necessary when any appliance is used by or near children.
4. Unplug from outlet when not in use, before putting on or taking off parts, and before cleaning.
5. Avoid contact with moving parts. Unplug from outlet when not in use, before putting on or taking off parts, and before cleaning.
6. Do not operate any appliance with a damaged cord or plug or after the appliance malfunctions or has been damaged in any manner. Return appliance to the manufacturer (see warranty) for examination, repair, or electrical or mechanical adjustment.
7. The use of attachments not recommended or sold by manufacturer may cause fire, electric shock or injury.
8. Do not let cord hang over edge of table or counter or touch heated surfaces.
9. Always make sure juicer cover is clamped securely in place before motor is turned on. Do not unfasten clamps while juicer is in operation.

10. Be sure to turn switch to OFF position after each use of your juicer. Make sure the motor stops completely before disassembling.
11. Do not put your fingers or other objects into the juicer while it is in operation. If food becomes lodged in opening, use food pusher or another piece of fruit or vegetable to push down the lodged food. When this method is not possible, turn off the machine, remove the plug from wall outlet and disassemble juicer to remove the remaining food.
12. Do not use outdoors.
13. Do not place on or near a hot gas or electric burner or in a heated oven.
14. Do not use appliance for anything other than its intended use.
15. Keep hands and utensils away from moving blades or discs while processing food to reduce the risk of severe injury to persons or damage to the food processor. A scraper may be used but must be used only when the food processor is not running.
16. Blades are sharp. Handle carefully.
17. Keep the appliance clean. Refer to the Care & Cleaning instructions in this manual.
18. DO NOT plug in until familiar with all the instructions and operating procedures.
19. DO NOT unplug from electrical outlet by pulling on the cord. To unplug, grasp the plug, not the cord, and pull.
20. Turn off all controls before unplugging from or plugging into an electrical outlet.
21. This appliance can not grind meat.
22. Check hopper for presence of foreign objects before using.
23. Moving parts – Keep fingers out of discharge openings.
24. Sharp blade – Always use food pusher.

## **Tips for Using the MM900HDS Cold Press Juicer**

### **How is it Optimized for Celery?**

'Precision Extraction' optimized for Celery (using the celery endcap included with the juicer), provides maximum extraction by squeezing Celery for longer resulting in more juice and less waste.

Juicing Tip: Use fresh crispy celery. Keep your stalks whole and long to feed through the chute rather than cutting into small pieces when juicing.

Do NOT juice more than 16 oz (450g) of celery juice at a time, remove pulp from drum, auger, screen and end cap before you begin juicing again.

### **What type of Celery is Best?**

For best juicing results, use fresh whole crispy celery stalks. Do not cut them in small pieces.

### **Why are There Two Adjustable End Caps?**

1. Special Celery Adjustable End Cap with Green Gasket / O-ring - To be used/attached exclusively for juicing celery – it is NOT meant to juice any other fruits or vegetables. The green insert squeezes every bit of juice out of your celery so you get more juice in every batch.

2. Fruit & Vegetable End Cap - For juicing all other fruits and vegetables.

### **What are some Tips for using the Special Green Endcap?**

The celery end cap is specifically designed to tightly squeeze the celery to get a maximum amount of juice out of each stalk. Because of this the pulp may get very dry.

Never tighten the celery end cap to the tightest setting if the pulp won't come out. When there is no juice coming out, and you notice pulp back up, loosen up end cap to allow pulp to come out. If that process does not remedy the situation, take the celery end cap off and clean it before continuing to juice more celery.

Do NOT juice more than 16 oz (450g) of celery juice at a time. Remove pulp from drum, auger, screen and end cap before you begin juicing again.

Do not keep juicing if there is no juice or pulp coming out. Remove pulp from drum, auger, screen and end cap before starting again.

### **What Do I Do if the Juice Flow Is Reduced Or Has Stopped?**

The celery end cap is design to have a tighter seal so it will hold the celery pulp inside for longer time to achieve higher juicing rate.

Sometimes the celery pulp can get too dry and temporarily back up. If this issue occurs, simply loosen the celery end cap so that the dry pulp can be squeezed out. Never keep the end cap on the tightest setting if the juice is not flowing properly.

You can also remove the end cap to clean with warm water, liquid dish soap and your included scrub brush and then replace to continue juicing.

### **What is the quantity of juice I can do at one time?**

Do NOT juice more than 16 oz (450g) of celery juice at a time. Remove pulp from drum, auger, screen and end cap before you begin juicing again.

### **How do I to Clean My Juicer?**

It's recommended that the celery cap is cleaned after every 16oz of celery juice is produced to prevent excessive dry pulp build up that will affect the juicing rate. When cleaning the celery cap ensure that the green O-ring is cleaned as well.

It is important to always scrub all sides and surfaces of your juicing parts with warm water, liquid dish soap and the included scrubbing brush after each use.

In addition to an everyday cleaning, a deep cleaning should be done based on use. You will need a one gallon bowl filled with warm water with approximately one cup of liquid

dishwasher soap which specifically states that it removes pulp and mineral buildup. Let the parts soak for 24 hours.

**Warning**

This content is compiled from multiple sources and is provided for reference purposes only. It may not be complete or fully applicable to all situations. If you are unable to resolve your issue, please contact the product manufacturer or an authorized service provider for official support.

---

Document generated by [ManualsFile](#)

