

## Operating Instructions

### About the features of your microwave oven.

*Throughout this manual, features and appearance may vary from your model.*

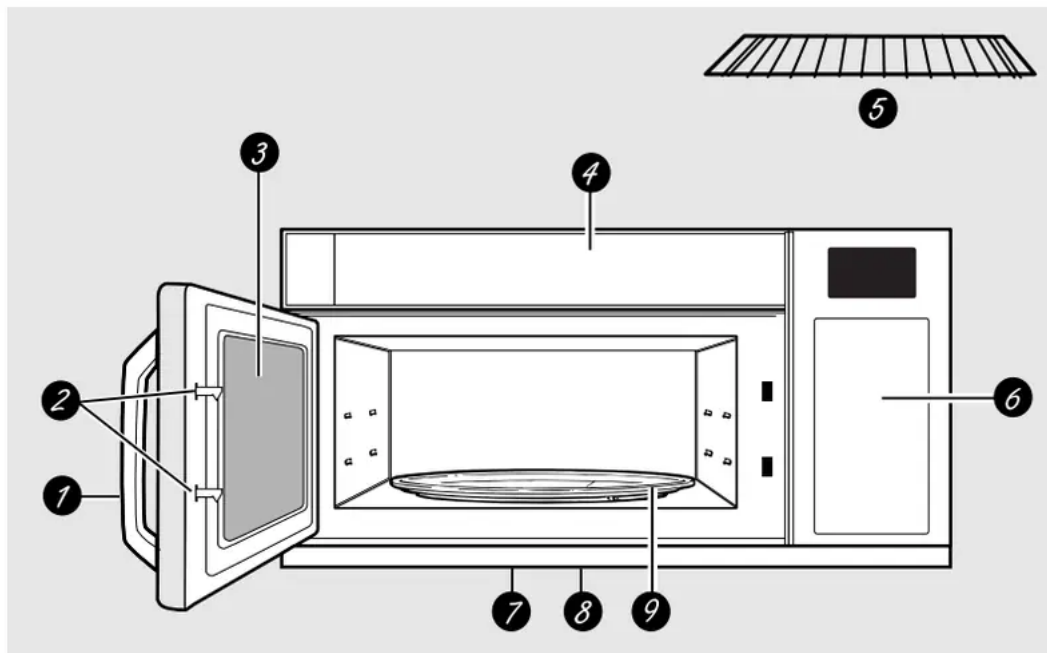

### Features of the Oven

**1. Door Handle.** Pull to open the door. The door must be securely latched for the microwave to operate.

**2. Door Latches.**

**3. Window with Metal Shield.**

Screen allows cooking to be viewed while keeping microwaves confined in the oven.

**4. Active Vent (on some models).** The vent door swings open when the fan operates and closes when the fan shuts off.

**5.Shelf.** Lets you microwave several foods at once. Food microwaves best when placed directly on the turntable.

**6.Touch Control Panel Display.**

**7.Cooktop Light.**

**8. Grease Filter.**

**9. Removable Turntable.**

Turntable and support **must** be in place when using the oven. The turntable may be removed for cleaning.

**NOTE:** Rating plate is located on the inside wall of the microwave, or on the upper left front behind the door. Oven vent(s) and oven light are located on the inside walls of the microwave oven.

You can microwave by time, with the sensor features or with the auto features.

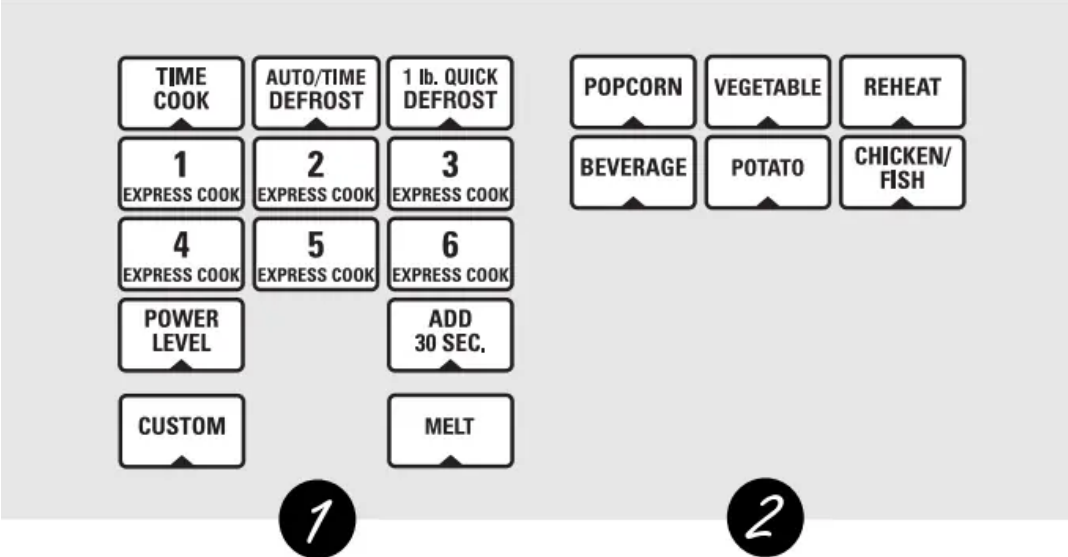

**Cooking Controls**

**1. Time and Auto Features**



<b><i>Press</i></b>	<b><i>Enter</i></b>
<b>TIME COOK I &amp; II</b> Press once or twice	Amount of cooking time
<b>AUTO/TIME DEFROST</b> Press twice	Amount of defrosting time
<b>CUSTOM</b> (on some models)	Follow displayed instructions
<b>EXPRESS COOK</b>	Starts immediately!
<b>ADD 30 SEC</b>	Starts immediately!
<b>POWER LEVEL</b>	Power level 1-10
<b>AUTO/TIME DEFROST</b> Press once	Food weight up to 6 lbs.
<b>1 lb. QUICK DEFROST</b>	Starts immediately!
<b>MELT</b> (on some models)	Food type

## **2. Sensor Features**



<b><i>Press</i></b>	<b><i>Enter</i></b>	<b><i>Option</i></b>
<b>POPCORN</b>	Starts immediately!	more/less time
<b>BEVERAGE</b>	Starts immediately!	
<b>REHEAT</b> Press once (plate of 3 foods) Press twice (pasta 8-12 oz.) Press three times (vegetables 1/2-2 cups)	Starts immediately!	more/less time more/ less time more/less time
<b>POTATO</b>	Starts immediately!	more/less time
<b>VEGETABLE</b> Press once (fresh vegetables) Press twice (frozen vegetables) Press three times (canned vegetables)	Starts immediately!	more/less time more/ less time more/less time (on some models)
<b>CHICKEN/FISH</b> (on some models)	Starts immediately!	more/less time

## About changing the power level.

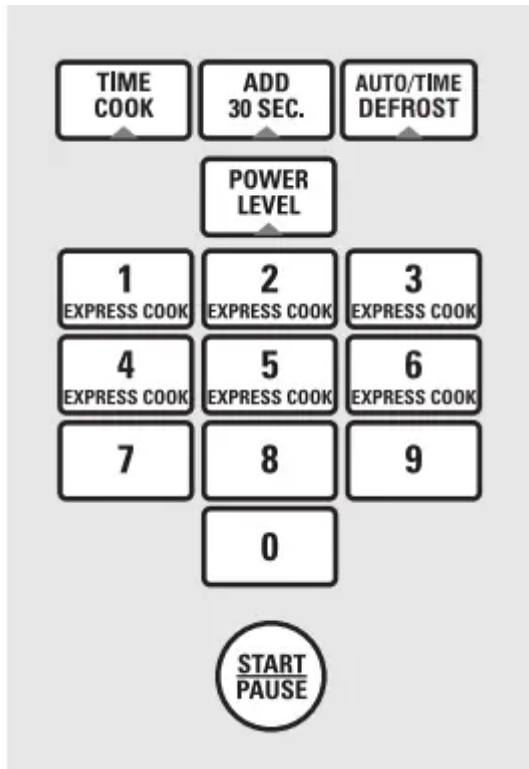

### ***How to Change the Power Level***

The power level may be entered or changed immediately after entering the feature time for **TIME COOK**, **TIME DEFROST**, **EXPRESS COOK** or **ADD 30 SEC.** The power level may also be changed during time countdown.

1. Press TIME COOK or select Time Defrost.
2. Enter cooking or defrosting time.
3. Press POWER LEVEL.
4. Select desired power level 1–10.
5. Press START.

Variable power levels add flexibility to microwave cooking. The power levels on the microwave oven can be compared to the surface units on a range. High (power level 10) or full power is the fastest way to cook and gives you 100% power. Each power level gives you microwave energy a certain percent of the time. Power level 7 is microwave energy 70% of the time. Power level 3 is energy 30% of the time.

A high setting (10) will cook faster but food may need more frequent stirring, rotating or turning over. Most cooking will be done on High (power level 10). A lower setting will cook more evenly and need less stirring or rotating of the food.

Some foods may have better flavor, texture or appearance if one of the lower settings is used. Use a lower power level when cooking foods that have a tendency to boil over, such as scalloped potatoes.

Rest periods (when the microwave energy cycles off) give time for the food to “equalize” or transfer heat to the inside of the food. An example of this is shown with power level 3—the defrost cycle. If microwave energy did not cycle off, the outside of the food would cook before the inside was defrosted.

Here are some examples of uses for various power levels:

Power Level	Best Uses
High 10	Fish, bacon, vegetables, boiling liquids.
Med-High 7	Gentle cooking of meat and poultry; baking casseroles and reheating.
Medium 5	Slow cooking and tenderizing such as stews and less tender cuts of meat.
Low 2 or 3	Defrosting without cooking; simmering; delicate sauces.
Warm 1	Keeping food warm without overcooking; softening butter

### About the time features.

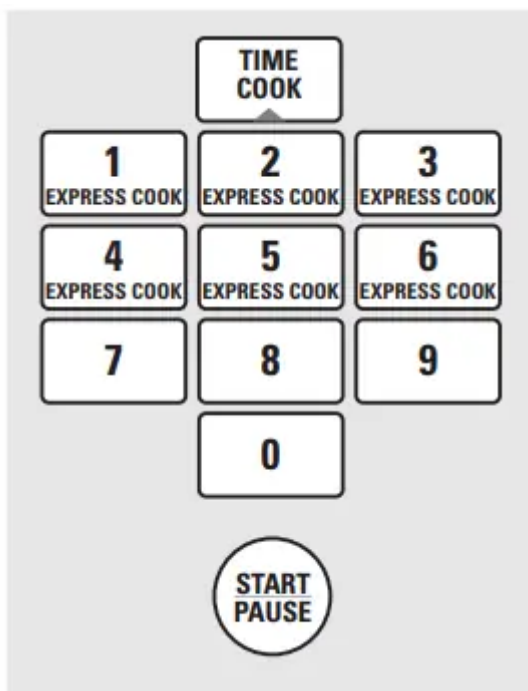

1. Press TIME COOK.

2. Enter cooking time.
3. Change power level if you don't want full power. (Press **POWER LEVEL**. Select a desired power level 1–10.)
4. Press **START**.

### ***Time Cook I***

Allows you to microwave for any time up to 99 minutes and 99 seconds.

Power level 10 (High) is automatically set, but you may change it for more flexibility.

You may open the door during **TIME COOK** to check the food. Close the door and press **START** to resume cooking.

### ***Time Cook II***

Lets you change power levels automatically during cooking. Here's how to do it:

1. Press **TIME COOK**.
2. Enter the first cook time.
3. Change the power level if you don't want full power. (Press **POWER LEVEL**. Select a desired power level 1-10.)
4. Press **TIME COOK** again.
5. Enter the second cook time.
6. Change the power level if you don't want full power. (Press **POWER LEVEL**. Select a power level 1-10.)
7. Press **START**.

At the end of **Time Cook I**, **Time Cook II** counts down.

### **Time Defrost**

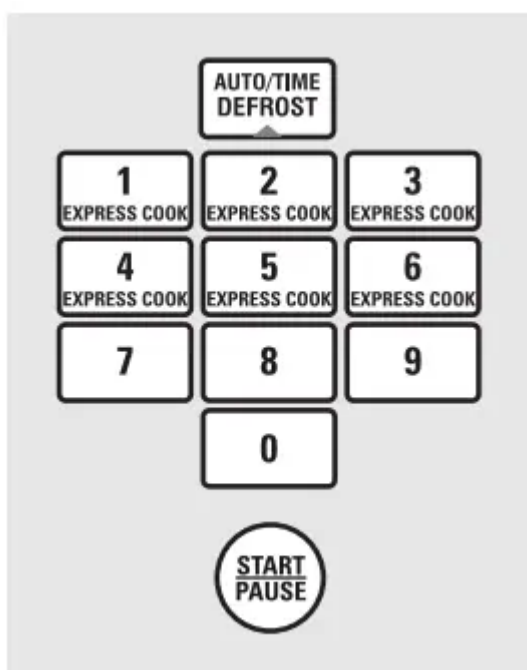

1. Press AUTO/TIME DEFROST twice.
2. Enter defrosting time.
3. Press START.

Allows you to defrost for the length of time you select. See the Defrosting Guide for suggested times.

Power level 3 is automatically set, but you may change this for more flexibility. You may defrost small items more quickly by raising the power level after entering the time. However, they will need more frequent attention than usual.

Power level 7 cuts the total defrosting time in about half; power level 10 cuts the total time to approximately 1/3. Rotate or stir food frequently.

A dull thumping noise may be heard during defrosting. This sound is normal when the oven is not operating at High power.

### ***Defrosting Tips***

- Foods frozen in paper or plastic can be defrosted in the package. Tightly closed packages should be slit, pierced or vented AFTER food has partially defrosted. Plastic storage containers should be at least partially uncovered.
- Family-size, prepackaged frozen dinners can be defrosted and microwaved. If the food is in a foil container, transfer it to a microwave-safe dish.
- Foods that spoil easily, such as milk, eggs, fish, stuffings, poultry and pork should not be allowed to sit out for more than one hour after defrosting. Room temperature promotes the growth of harmful bacteria.

- For more even defrosting of larger foods, such as beef, lamb and veal roasts, use **Auto Defrost**.
- Be sure large meats are completely defrosted before cooking.
- When defrosted, food should be cool but softened in all areas. If still slightly icy, return to the microwave very briefly, or let it stand a few minutes.

### Express Cook

*This is a quick way to set cooking time for 1-6 minutes.*



Press one of the **Express Cook** pads (from 1 to 6) for 1 to 6 minutes of cooking at **power level 10**.

For example, press the **2** pad for 2 minutes of cooking time.

The power level can be changed as time is counting down. Press **POWER LEVEL** and enter 1-10.

### Add 30 Seconds



*You can use this feature two ways:*

- It will add 30 seconds to the time counting down each time the pad is pressed.
- It can be used as a quick way to set 30 seconds of cooking time.

## About the auto features.

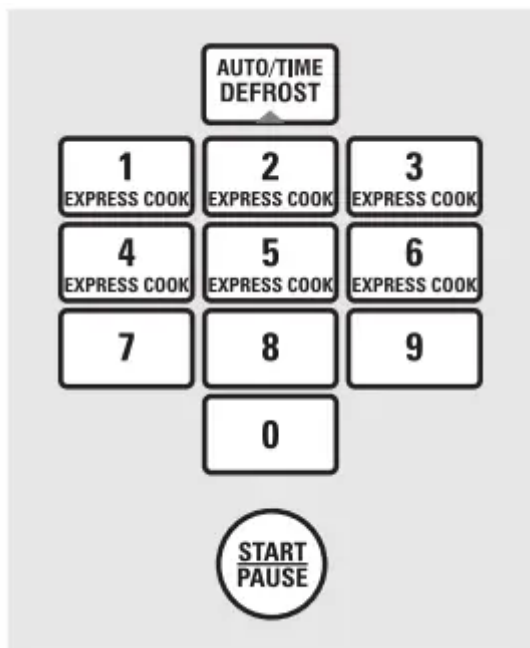

1. Press AUTO/TIME DEFROST once for Auto Defrost.
2. Using the Conversion Guide at right, enter food weight. For example, press pads 1 and 2 for 1.2 pounds (1 pound, 3 ounces). Enter weight up to 6 pounds for Auto Defrost.
3. Press START.

### ***Auto Defrost***

***Auto Defrost*** automatically sets the defrosting times and power levels to give even defrosting results for meats, poultry and fish weighing up to six pounds.

- Twice during ***Auto Defrost***, the oven signals ***Turn Food Over***. At each signal, turn the food over. Remove defrosted meat or shield warm areas with small pieces of foil.
- After defrosting, most meats need to stand 5 minutes to complete defrosting. Large roasts should stand for about 30 minutes.

## **Conversion Guide**

If the weight of food is stated in pounds and ounces, the ounces must be converted to tenths (.1) of a pound.

<b>Weight of Food in Ounces</b>	<b>Enter Food Weight (tenths of a pound)</b>	<b>Weight of Food in Ounces</b>	<b>Enter Food Weight (tenths of a pound)</b>
1–2	.1	9–10	.6
3	.2	11	.7
4–5	.3	12–13	.8
6–7	.4	14–15	.9
8	.5		

### **1 lb. Quick Defrost**



1 lb. Quick Defrost automatically sets the defrosting times and power levels for foods weighing one pound. Press 1 lb. Quick Defrost. The oven starts automatically. When the oven signals, turn food over.

### **Melt (on some models)**

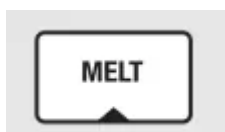

1. Press MELT.
2. Enter number for food type.
3. Press START.

A convenient way to melt frequently used food items.

<b>Food Item</b>	<b>Quantity</b>	<b>Enter</b>
<b>Butter</b>	2, 4 or 8 oz	1
<b>Chocolate Chips</b>	2-16 oz	2
<b>Marshmallow</b>	2-16 oz	3
<b>Caramel</b>	2-16 oz	4
<b>Cheese</b>	2-32 oz	5

About the sensor features.

Humidity Sensor

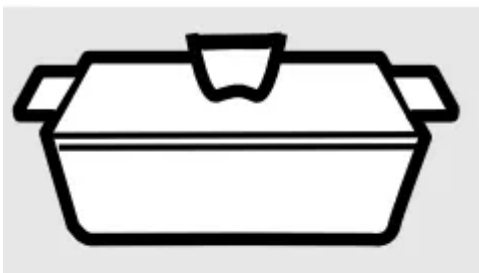

Covered

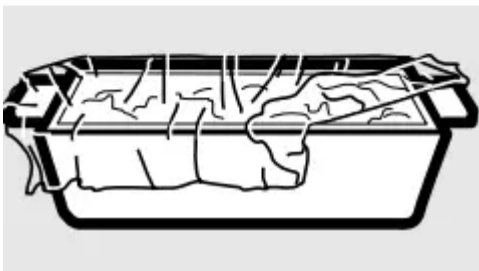

Vented



Dry off dishes so they don't mislead the sensor.

**What happens when using the Sensor Features:**

The Sensor Features detect the increasing humidity released during cooking. The oven automatically adjusts the cooking time to various types and amounts of food.

Do not use the Sensor Features twice in succession on the same food portion—it may result in severely overcooked or burnt food. If food is undercooked after the countdown, use **Time Cook** for additional cooking time.

The proper containers and covers are essential for best sensor cooking.

Always use microwave-safe containers and cover them with lids or vented plastic wrap. Never use tight sealing plastic containers—they can prevent steam from escaping and cause food to overcook.

Be sure the outside of the cooking containers and the inside of the microwave oven are dry before placing food in the oven. Beads of moisture turning into steam can mislead the sensor.

### **Beverage**



Press **BEVERAGE** once to heat an 8-10 oz cup of coffee or other beverage.

***Drinks heated with the Beverage feature may be very hot. Remove the container with care.***

If food is undercooked after the countdown use **Time Cook** for additional cooking time.

### **Popcorn**

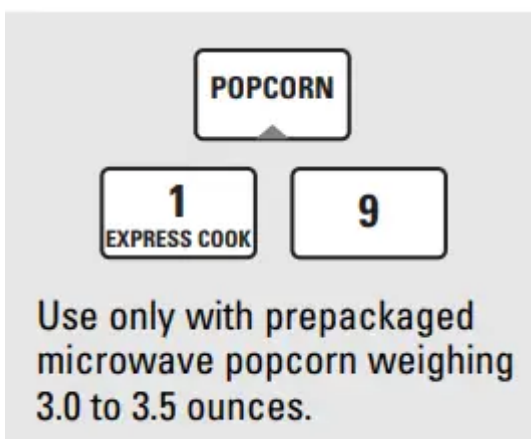

#### ***How to Use the Popcorn Feature***

1. Follow package instructions, using Time Cook if the package is less than 3.0 ounces or larger than 3.5 ounces. Place the package of popcorn in the center of the microwave.
2. Press **POPCORN** for a regular size (3.0 to 3.5 oz) bag of popcorn. The oven starts immediately.

If you open the door while **POPCORN** is displayed, an error message will appear. Close the door and press **START**.

If food is undercooked after the countdown use **Time Cook** for additional cooking time.

### **How to Adjust the Popcorn Program to Provide a Shorter or Longer Cook Time**

If you find that the brand of popcorn you use underpops or overcooks consistently, you can add or subtract 20-30 seconds to the automatic popping time.

#### **To add time:**

After pressing **POPCORN**, press **9** within the first 30 seconds after the oven starts for an extra 20 seconds.

Press **9** again to add another 10 seconds (total 30 seconds additional time).

#### **To subtract time:**

After pressing **POPCORN**, press **1** within the first 30 seconds after the oven starts for 20 seconds less cooking time.

Press **1** again to reduce cooking time another 10 seconds (total 30 seconds less time).

### **Reheat**

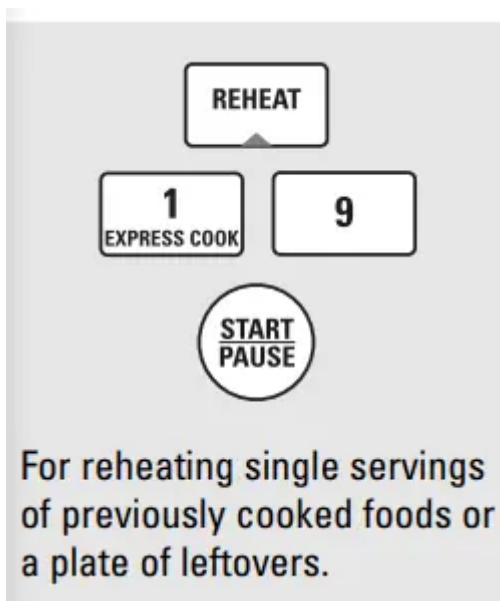

#### **How to Use the Reheat feature:**

1. Place the cup of liquid or covered food in the oven. Press **REHEAT** once, twice or three times. The oven starts immediately.

Press once for a plate of leftovers.

Press twice for pasta (8-12 oz).

Press three times for vegetables (1/2 to 2 cups).

2. The oven signals when steam is sensed and the time remaining begins counting down.

Do not open the oven door until time is counting down. If the door is opened, close it and press **START** immediately.

After removing food from the oven, stir, if possible, to even out the temperature. Reheated foods may have wide variations in temperature. Some areas may be extremely hot.

If food is not hot enough after the countdown use **Time Cook** for additional reheating time.

### **How to Change the Automatic Settings:**

*To reduce time by 10%:*

Press **1** within 30 seconds after pressing the **REHEAT** pad.

*To add 10% to cooking time:*

Press **9** within 30 seconds after pressing the **REHEAT** pad.

### **Some Foods Not Recommended For Use With Reheat:**

It is best to use **Time Cook** for these foods:

- Bread products.
- Foods that must be reheated uncovered.
- Foods that need to be stirred or rotated.
- Foods calling for a dry look or crisp surface after reheating.

### **Sensor Cooking**

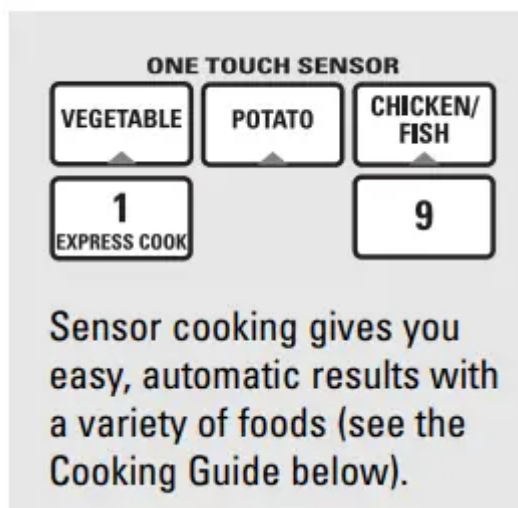

1. Place covered food in the oven. Press the food pad. For vegetables, press the **VEGETABLE** pad once for fresh vegetables, twice for frozen vegetables or three times for canned vegetables. For chicken or fish, press the **CHICKEN/FISH** pad once for chicken pieces or twice for fish. The oven starts immediately.

- The oven signals when steam is sensed and the time remaining begins counting down.  
Turn or stir the food if necessary.

Do not open the oven door until time is counting down. If the door is opened, close it and press **START** immediately.

If food is undercooked after the countdown use **Time Cook** for additional cooking time.

**How to Change the Automatic Settings (automatic settings for canned vegetables cannot be adjusted on some models):**

You can adjust the cooking time for all foods to suit your personal taste.

*To reduce time by 10%:*

Press **1** within 30 seconds after pressing the food pad.

*To add 10% to cooking time:*

Press **9** within 30 seconds after pressing the food pad.

### ***Cooking Guide***

<b><i>Food Type</i></b>	<b><i>Amount</i></b>	<b><i>Comments</i></b>
<b><i>Canned Vegetables</i></b>	4–16 oz	Cover with lid or vented plastic wrap.
<b><i>Frozen Vegetables</i></b>	4–16 oz	Follow package instructions for adding water. Cover with lid or vented plastic wrap.
<b><i>Fresh Vegetables</i></b>	4–16 oz	Add 1/4 cup water per serving. Cover with lid or vented plastic wrap.
<b><i>Potatoes</i></b>	8–32 oz	Pierce skin with fork. Place potatoes on the turntable.
<b><i>Fish*</i></b>	4–16 oz	Cover with vented plastic wrap.
<b><i>Chicken Pieces*</i></b>	2–8 pieces	Cover with vented plastic wrap.

\*On some models

**Other features your model may have.**

**Custom**

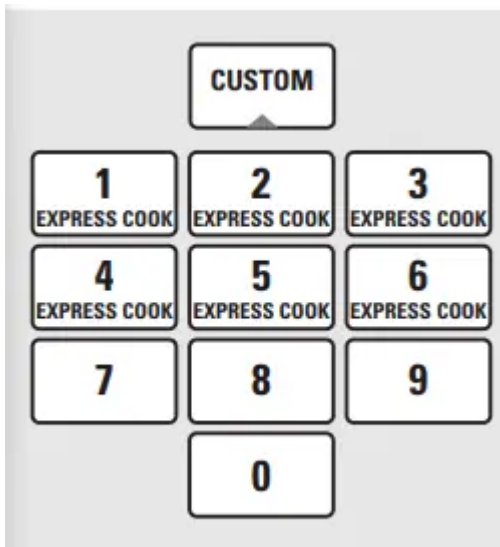

The **CUSTOM** pad allows you to save your most frequently used settings. (Sensor cooking settings cannot be saved.)

To set and save a setting:

1. Press the **CUSTOM** pad.
2. Set the amount of cooking time.
3. Set the power level, if desired. (Full power will automatically be set if you do not change it.)
4. Press the **CUSTOM** pad.

Your custom setting will be remembered for future one touch use.

To clear the custom setting, press and hold the **CUSTOM** pad for 2 seconds.

## Help



The **HELP** pad displays feature information and helpful hints. Press **HELP**; then select a feature pad.

## Cooking Complete Reminder

To remind you that you have food in the oven, the oven will display **FOOD ISREADY** and beep once a minute until you either open the oven door or press **CLEAR/OFF**.

## Clock

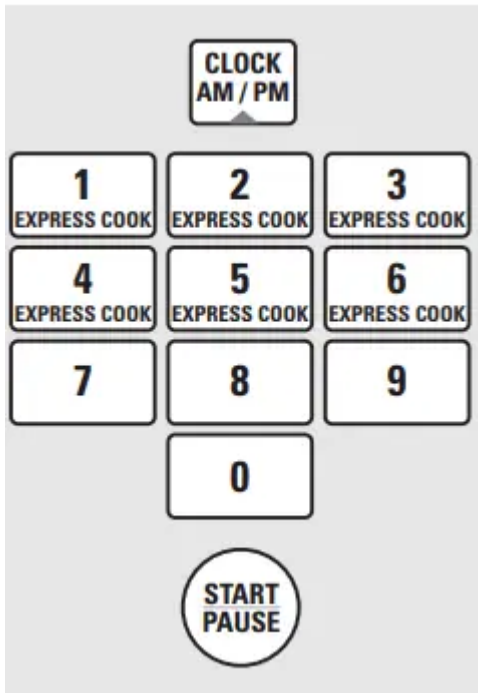

Press CLOCK to set the time of day.

1. Press CLOCK.
2. Enter the time of day.
3. Select AM or PM.
4. Press START.

To check the time of day while microwaving, press CLOCK.

### **Delay Start**

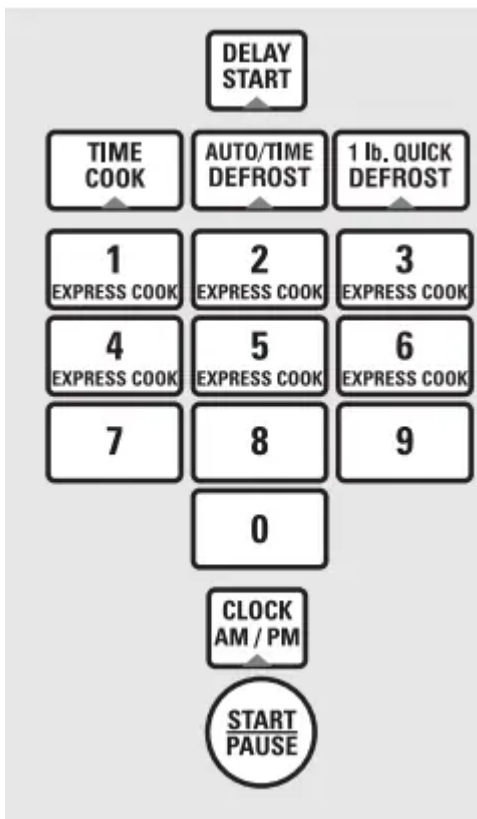

Delay Start allows you to set the microwave to delay cooking up to 24 hours.

1. Press DELAY START.
2. Select the cooking or defrosting feature you wish to delay; then enter the cooking or defrosting time.
3. Press START.
4. Enter the time you want the oven to start.
5. Be sure the microwave clock shows the correct time of day.)
6. Select AM or PM.
7. Press START.

The start time will be displayed and will remain until the oven automatically starts at the delayed time.

The time of day may be displayed by pressing CLOCK

## Timer

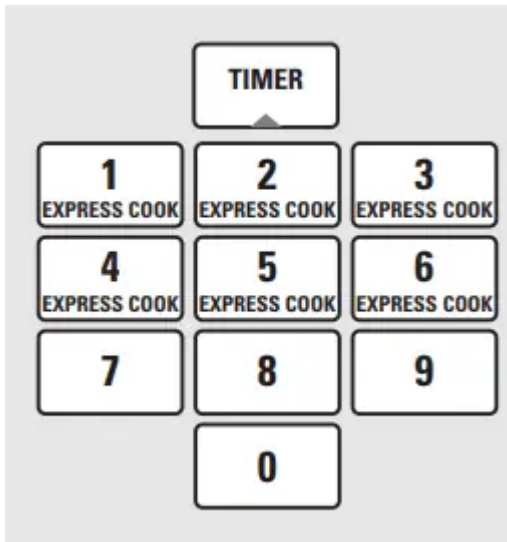

Timer operates as a minute timer and can be used at any time, even when the oven is operating.

1. Press TIMER.
2. Enter time you want to count down.
3. Press TIMER to start.

To pause the countdown, press TIMER.

When time is up, the oven will signal. To turn off the timer signal, press TIMER.

NOTE: The timer indicator will be lit while the timer is operating.

To cancel the timer, press and hold the TIMER pad for 2 seconds.

### Reminder

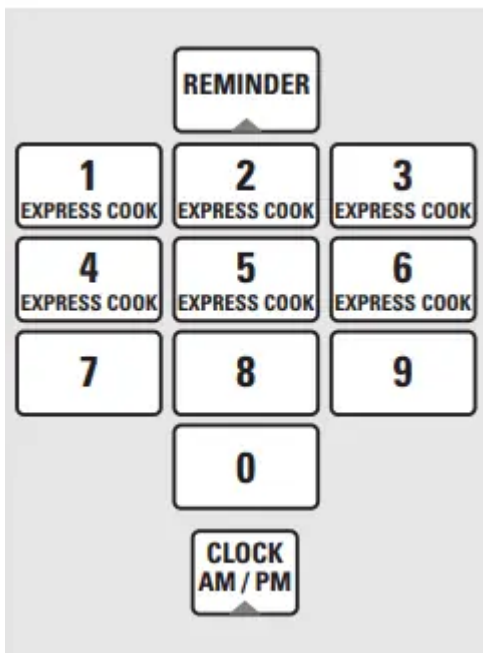

The Reminder feature can be used like an alarm clock, and can be used at any time, even when the oven is operating. The Reminder time can be set up to 24 hours later.

1. Press REMINDER.
2. Enter the time you want the oven to remind you. (Be sure the microwave clock shows the correct time of day.)
3. Select AM or PM.
4. Press REMINDER. When Reminder signal occurs, press REMINDER to turn it off. The Reminder time may be displayed by pressing REMINDER.

NOTE: The REM indicator will remain lit to show that the

Reminder is set. To clear the Reminder before it occurs, press and hold the REMINDER pad for 2 seconds.

### **Start/Pause**



In addition to starting many functions, START/PAUSE allows you to stop cooking without opening the door or clearing the display.

### **Child Lock-Out**



You may lock the control panel to prevent the microwave from being accidentally started or used by children. To lock or unlock the controls, press and hold CLEAR/OFF for about three seconds. When the control panel is locked, CONTROL LOCKED or LOCKED will be displayed.

### **Turntable**



For best cooking results, leave the turntable on.

It can be turned off for large dishes. Press **TURNTABLE** to turn the turntable on or off.

Sometimes the turntable can become too hot to touch.

Be careful touching the turntable during and after cooking.

### Vent Fan



The vent fan removes steam and other vapors from surface cooking.

Press **VENTFAN** once for high fan speed, twice for medium fan speed, a third time for low fan speed or a fourth time to turn the fan off.

Press the **VENT FAN BOOST** pad (on some models) for extra fan speed.

### Automatic Fan

An automatic fan feature protects the microwave from too much heat rising from the cooktop below it. It automatically turns on if it senses too much heat.

If you have turned the fan on, you may find that you cannot turn it off. The fan will automatically turn off when the internal parts are cool. It may stay on for 30 minutes or more after the cooktop and microwave controls are turned off.

### Surface Light



Press **SURFACE LIGHT** once for bright light, twice for the night light, or three times to turn the light off.

### Options

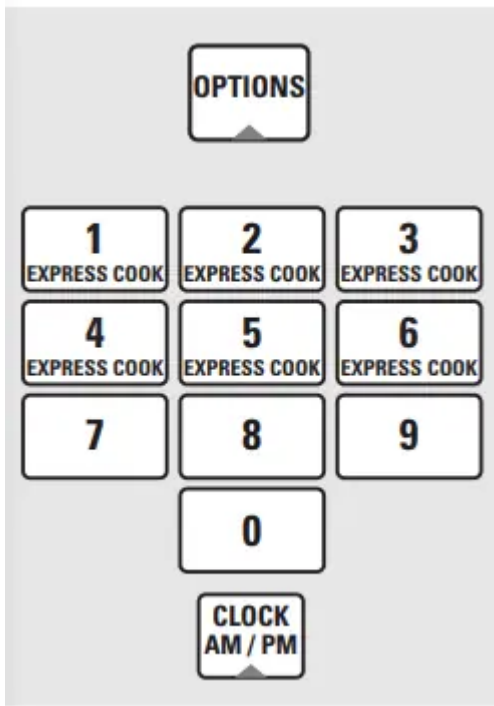

Press the OPTIONS pad multiple times to cycle through the available options.

### ***Auto Nite Light***

The Auto Nite Light can be set to come on and go off at desired times.

To set the timer:

1. Press 1.
2. Enter the time of day for the light to come on.
3. Select AM or PM.
4. Press the OPTIONS pad.
5. Enter the time of day for the light to go off.
6. Select AM or PM.
7. Press the OPTIONS pad.

To review the nite light settings, press **2** after selecting the ***Auto Nite Light*** option.

To turn the nite light off, press **0** after selecting the ***Auto Nite Light*** option.

### ***Beeper Volume***

The beeper sound level can be adjusted. Choose 0-3 for mute to loud.

### ***Charcoal Filter Reminder***

The ***Charcoal Filter Reminder*** is a 180-day timer to remind you when to change the charcoal filter. Press **0** to turn the reminder off. Press **1** to set the reminder. Press **2** to reset the reminder.

### ***Display Language (on some models)***

The language for the scrolling display may be set at either English or Spanish.

Press **1** for English or **2** for Spanish.

### ***Display On/Off***

You can choose to turn the clock display on or off. Press **0** to turn the display off. Press **1** to turn the display on.

### ***Display Speed***

The scroll speed of the display can be changed. Select 1-5 for slowest to fastest scroll speed.

### **Shelf**

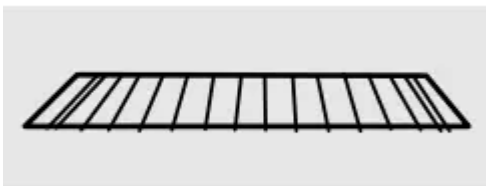

### ***How to Use the Shelf When Microwaving***

- Make sure the shelf is positioned properly inside the microwave to prevent damage to the oven from arcing.
- Do not use a microwave browning dish on the shelf. The shelf could overheat.
- Do not use the oven with the shelf on the microwave floor. This could damage the microwave.
- Use pot holders when handling the shelf— it may be hot.
- Do not use the shelf when cooking popcorn.
- Do not use the shelf with Sensor Cooking or ***Reheat***.

Food microwaves best when placed on the turntable or on the shelf in the lower position. Only use the shelf when reheating on more than one level. Do not store the shelf inside the oven cavity

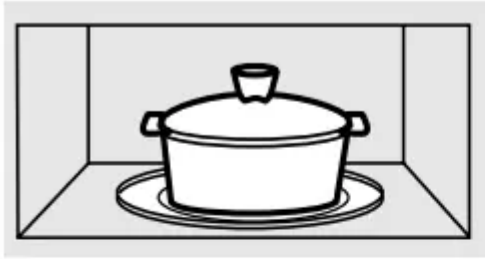

For best results



Uneven results

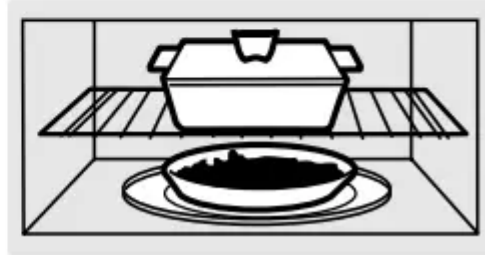
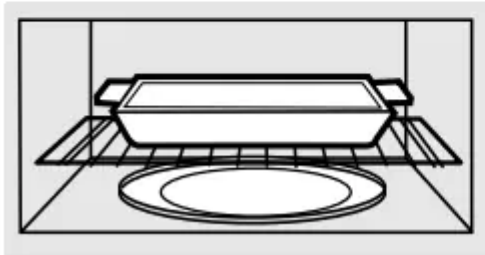

2-level reheating

### Shelf and Reheating

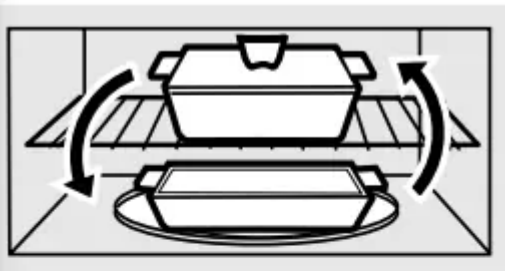

Switch places after 1/2 time

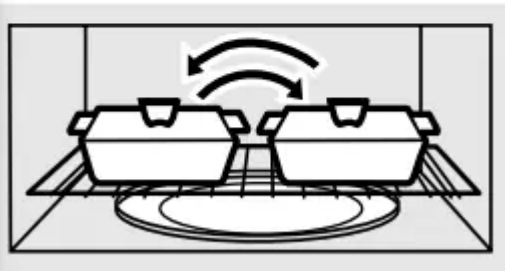

Switch places after 1/2 time

- To reheat on 2 levels



OR

- To reheat 2 dishes on the lower level:

1. Multiply reheat time by 1&1/2.
2. Switch places after 1/2 the time.



Switch places twice

- To reheat on 3 levels (on some models):

1. Turn the turntable off.
2. Double the reheating time.
3. Switch places twice and give the dishes a 1/2 turn during reheating. (Place dense foods, or those that require a longer cook time, on the upper shelf first.)

## Microwave terms.

<b>Term</b>	<b>Definition</b>
<b>Arcing</b>	<p>Arcing is the microwave term for sparks in the oven. Arcing is caused by:</p> <ul style="list-style-type: none"><li>■ the metal shelf being installed incorrectly and touching the microwave walls.</li><li>■ metal or foil touching the side of the oven.</li><li>■ foil that is not molded to food (upturned edges act like antennas).</li><li>■ metal such as twist-ties, poultry pins, gold-rimmed dishes.</li><li>■ recycled paper towels containing small metal pieces.</li></ul>
<b>Covering</b>	<p>Covers hold in moisture, allow for more even heating and reduce cooking time. Venting plastic wrap or covering with wax paper allows excess steam to escape.</p>
<b>Shielding</b>	<p>In a regular oven, you shield chicken breasts or baked foods to prevent over-browning. When microwaving, you use small strips of foil to shield thin parts, such as the tips of wings and legs on poultry, which would cook before larger parts.</p>
<b>Standing Time</b>	<p>When you cook with regular ovens, foods such as roasts or cakes are allowed to stand to finish cooking or to set. Standing time is especially important in microwave cooking. Note that a microwaved cake is not placed on a cooling rack.</p>
<b>Venting</b>	<p>After covering a dish with plastic wrap, you vent the plastic wrap by turning back one corner so excess steam can escape.</p>

## Care and cleaning of the microwave oven.

### Helpful Hints



An occasional thorough wiping with a solution of baking soda and water keeps the inside fresh.

NOTE: Be certain the power is off before cleaning any part of this oven.

### How to Clean the Inside

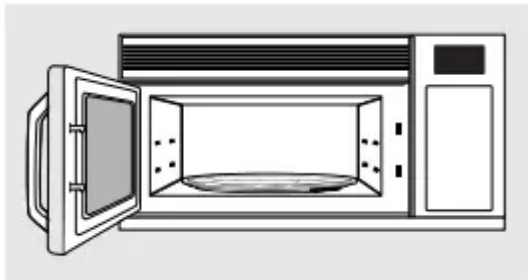

#### ***Walls, Floor, Inside Window, Metal and Plastic Parts on the Door***

Some spatters can be removed with a paper towel; others may require a damp cloth. Remove greasy spatters with a sudsy cloth; then rinse with a damp cloth. Do not use abrasive cleaners or sharp utensils on oven walls.

**Never use a commercial oven cleaner on any part of your microwave.**

#### ***Removable Turntable and Turntable Support***

To prevent breakage, do not place the turntable into water just after cooking. Wash it carefully in warm, sudsy water or in the dishwasher. The turntable and support can be broken if dropped. Remember, do not operate the oven without the turntable and support in place.

#### ***Shelf***

Clean with mild soap and water or in the dishwasher.

Do not clean in a self-cleaning oven.

***Temperature Probe (on some models)***

Clean immediately after using. To clean, wipe with a sudsy cloth, then rub lightly with a plastic scouring ball if necessary. Rinse and dry. The probe can also be washed in the dishwasher.

### **How to Clean the Outside**

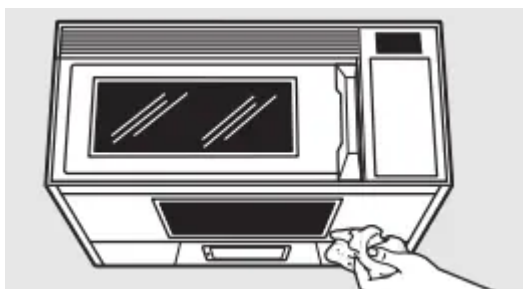

We recommend against using cleaners with ammonia or alcohol, as they can damage the appearance of the microwave oven. If you choose to use a common household cleaner, first apply the cleaner directly to a clean cloth, then wipe the soiled area.

#### **Case**

Clean the outside of the microwave with a sudsy cloth. Rinse and then dry. Wipe the window clean with a damp cloth.

#### **Control Panel**

Wipe with a damp cloth. Dry thoroughly. Do not use cleaning sprays, large amounts of soap and water, abrasives or sharp objects on the panel—they can damage it. Some paper towels can also scratch the control panel.

#### **Door Panel**

Before cleaning the front door panel, make sure you know what type of panel you have. Refer to the eighth digit of the model number (eleventh digit on models JVM1850, JNM1851 and DVM1850). “S” is stainless steel, “G” is Graphite, “L” is CleanSteel and “B”, “W” or “C” are plastic colors.

#### **Stainless Steel**

The stainless steel panel can be cleaned with Stainless Steel Magic or a similar product using a clean, soft cloth. Apply stainless cleaner carefully to avoid the surrounding plastic parts. Do not use appliance wax, polish, bleach or products containing chlorine on Stainless Steel finishes.

#### **CleanSteel, Graphite**

Use a clean, soft, light and lightly dampened cloth, then dry thoroughly. Do not use appliance wax, polish, bleach or products containing any chemical agent on the CleanSteel surfaces.

#### **Plastic Color Panels**

Use a clean, soft, lightly dampened cloth, then dry thoroughly.

#### **Door Seal**

It's important to keep the area clean where the door seals against the microwave. Use only mild, non-abrasive detergents applied with a clean sponge or soft cloth. Rinse well.

### **Bottom**

Clean off the grease and dust on the bottom often. Use a solution of warm water and detergent.

### **Cooktop Light/Night Light**

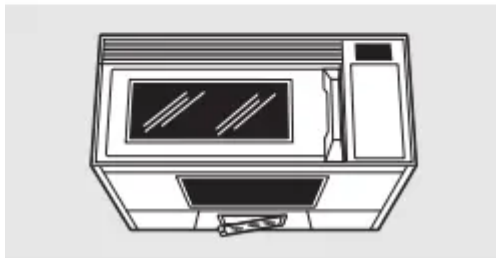
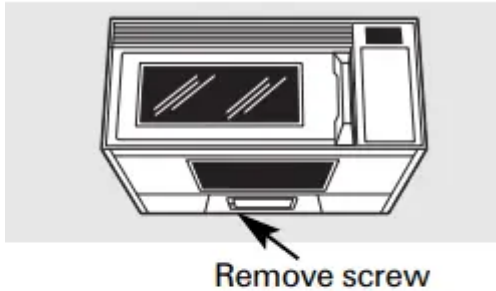

On models JVM1850, JNM1851, DVM1850 and EMO4000, replace the burned-out bulb with a 120 volt, 40-watt incandescent bulb (WB36X10003), available from your GE supplier.

On models JVM1870, JVM1871, JVM2050 and JVM3670, replace the burned-out bulb with a 120 volt, 20-watt halogen bulb (WB36X10213), available from your GE supplier.

1. To replace the bulb(s), first disconnect the power at the main fuse or circuit breaker panel or pull the plug.
2. Remove the screw at the left edge of the light cover and push on the right edge of the cover to open.
3. Be sure the bulb(s) to be replaced are cool before removing. After breaking the adhesive seal, remove the bulb by either gently turning (for models JVM1850, JNM1851, DVM1850 and EMO4000) or pulling straight out (for models JVM1870, JVM1871, JVM2050 and JVM3670). Replace with the same size and type bulb.
4. Raise the light shield and replace the screw. Connect electrical power to the oven.

### **Replacing the light bulbs.**

#### **Oven Light**

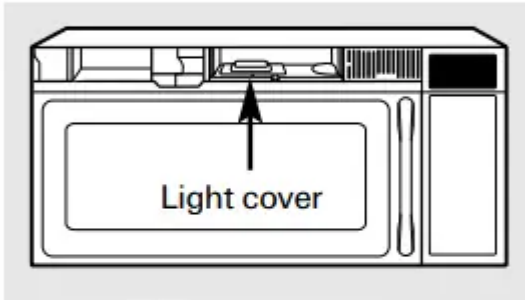
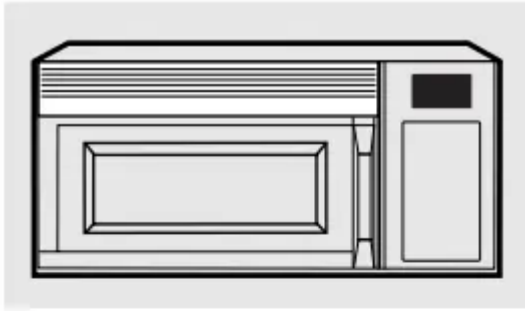

On some models

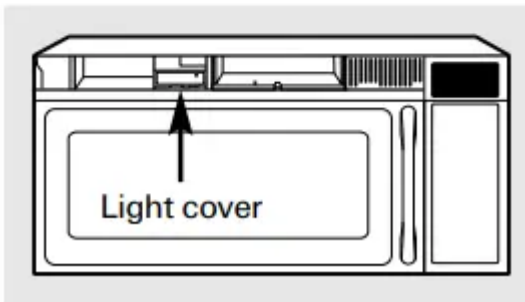

On some models

Replace the burned-out bulb with a 120 volt, 20-watt halogen bulb (WB36X10213), available from your GE supplier.

1. To replace the oven light, first disconnect the power at the main fuse or circuit breaker panel or pull the plug.
2. Remove the top grille by taking out the screws on top of the grille that hold it in place and sliding the grille to the left (opening the door makes grille removal easier).
3. Next, remove the light cover.

On some models, the light cover is located in the center of the top opening. Remove the screw that secures the light cover and lift the cover off.

On some models, the light cover is located at the left of the top opening. Lift the cover off.

4. Pinch the clips that hold the light socket in place and lift the socket out.

5. Remove the bulb from the light socket by pulling straight out. Replace with the same size and type bulb, then replace the light socket and cover.
6. Replace the grille and screws. Connect electrical power to the oven.

## About the exhaust feature.

### The Vent Fan

The vent fan has a metal reusable grease filter.

Models that recirculate air back into the room also use a charcoal filter.

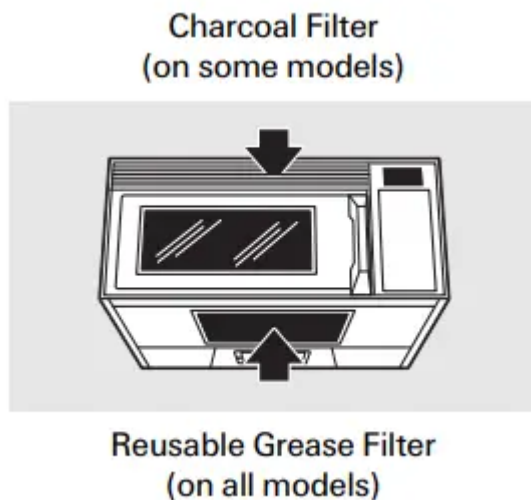

### Reusable Grease Filter

The reusable grease filter traps grease released by foods on the cooktop. It also prevents flames from foods on the cooktop from damaging the inside of the microwave.

For this reason, the filter must ALWAYS be in place when the hood is used. The grease filter should be cleaned once a month, or as needed.

### Removing and Cleaning the Filter



**To remove**, slide it to the side using the tab.

Pull it down and out.

**To clean the grease filter**, soak it and then swish it around in hot water and detergent. Don't use ammonia or ammonia products because it will darken the metal. Light brushing can be used to remove embedded dirt.

Rinse, shake and let it dry before replacing.

**To replace**, slide the filter in the frame slot at the side of the opening. Pull up and in to lock into place.

### **Charcoal Filter (on some models)**

The charcoal filter cannot be cleaned. It must be replaced.

For JVM1800 and JVM3600 Series models, order Part No. WB2X10733 from your GE supplier.

For JVM2000 Series models, order Part No. WB2X10956 from your GE supplier.

If the model is not vented to the outside, the air will be recirculated through a disposable charcoal filter that helps remove smoke and odors.

The charcoal filter should be replaced when it is noticeably dirty or discolored (usually after 6 to 12 months, depending on hood usage). See "Optional Kits", page 10, for more information.

### **To Remove Charcoal Filter**

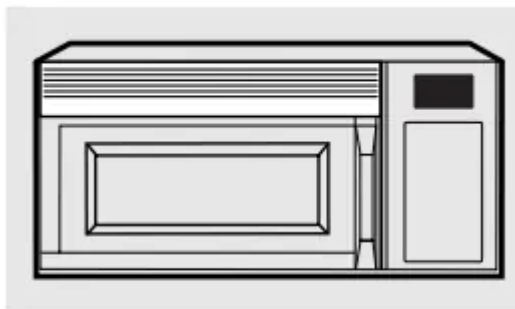

**Remove grille screws  
to remove the grille.**

To remove the charcoal filter, disconnect power at the main fuse or circuit breaker panel or pull the plug.

Remove the top grille by removing the screws on top of the grille that hold it in place and sliding the grille to the left (opening the door makes grille removal easier). Slide the filter towards the front of the oven and remove it.

### **To Install Charcoal Filter**

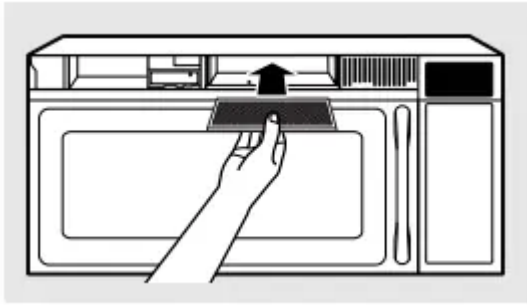

To install a new filter, remove plastic and other outer wrapping from the new filter.

Insert the filter into the top opening of the oven as shown. It will rest at an angle on 2 side support tabs and in front of the right rear tab. Replace the grille and screws.

## Troubleshooting Tips



<b><i>Problem</i></b>	<b><i>Possible Causes</i></b>	<b><i>What To Do</i></b>
<b><i>Oven will not start</i></b>	<b>A fuse in your home may be blown or the circuit breaker tripped.</b>	Replace fuse or reset circuit breaker.
	<b>Power surge.</b>	Unplug the microwave oven; then plug it back in.
	<b>Plug not fully inserted into wall outlet.</b>	Make sure the 3-prong plug on the oven is fully inserted into wall outlet.
	<b>Door is not closed.</b>	Open and close the door securely.
<b><i>Floor of the oven is warm, even when the oven has not been used</i></b>	<b>Heat from the cooktop light may make the oven floor get warm.</b>	This is normal.
<b><i>"CONTROL LOCKED" or "LOCKED" appears on the display</i></b>	<b>The control has been locked.</b>	Press and hold <b>CLEAR/OFF</b> for about 3 seconds to unlock the control.
<b><i>"SENSOR ERROR" appears on the display</i></b>	<b>When using a Sensor feature, the door was opened before steam could be detected.</b>	Do not open door until steam is sensed and time is shown counting down on the display.
	<b>Steam was not detected in maximum amount of time.</b>	Use <b>Time Cook</b> to heat for more time.
<b><i>You hear an unusual, low-tone beep</i></b>	<b>You have tried to start the Reminder without a valid time of day.</b>	Start over and enter a valid time of day.
	<b>You have tried to start the Auto Nite Light without a valid time of day entered for the on-time and off-time.</b>	Start over and enter a valid time of day.
		Many of the oven's features are preset and cannot be changed.

	<b>You have tried to change the power level when it is not allowed.</b>	
<b>Food amount too large for Sensor Reheat</b>	<b>Sensor Reheat is for single servings of recommended foods.</b>	Use <b>Time Cook</b> for large amounts of food.

## Things That Are Normal With Your Microwave Oven

- Moisture on the oven door and walls while cooking. Wipe the moisture off with a paper towel or soft cloth.
- Moisture between the oven door panels when cooking certain foods. Moisture should dissipate shortly after cooking is finished.
- Steam or vapor escaping from around the door.
- Light reflection around door or outer case.
- Dimming oven light and change in the blower sound at power levels other than high.
- Dull thumping sound while oven is operating.
- TV/radio interference might be noticed while using the microwave. Similar to the interference caused by other small appliances, it does not indicate a problem with the microwave. Plug the microwave into a different electrical circuit, move the radio or TV as far away from the microwave as possible, or check the position and signal of the TV/radio antenna.
- The Active Vent door (on some models) will open during operation, and remain open while the microwave is running, to keep the electronics cool. It is also normal to hear a clicking noise as the vent door opens and closes.

### Warning

This content is compiled from multiple sources and is provided for reference purposes only. It may not be complete or fully applicable to all situations. If you are unable to resolve your issue, please contact the product manufacturer or an authorized service provider for official support.