

Operating Instructions

About the features of your oven.

Throughout this manual, features and appearance may vary from your model.

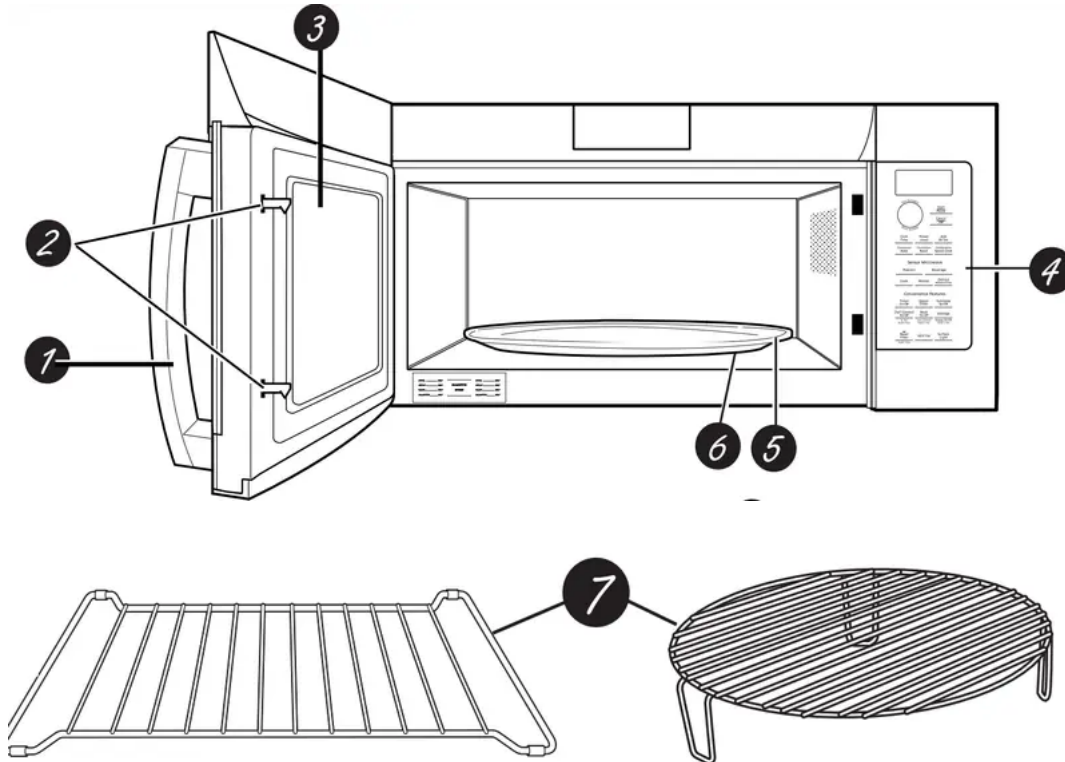

Features of the Oven

1. Door Handle.
2. Door Latches.
3. Window with Metal Shield. Screen allows cooking to be viewed while keeping microwaves confined in the oven.
4. Control Panel and Selector Dial.
5. Removable Turntable. Do not operate the oven in the microwave mode without the turntable and turntable support seated and in place.
6. Removable Turntable Support. Do not operate the oven in the microwave mode without the turntable and turntable support seated and in place.
7. Shelves. Use with Convection Bake, Convection Roast or Combination Fast Bake. (Do not use when microwave cooking.)

For best results, use one shelf in the lower position and leave at least a 1-inch gap between the cooking dish and the sides of the oven. For two - level Baking and Fast Baking use both shelves.

About the cooking and warming features of your microwave/convection oven.

You can cook by Microwave, Convection Bake, Convection Roast or Combination Fast Bake. Keep hot, cooked foods at serving temperature with the Warm feature.

Cooking Controls



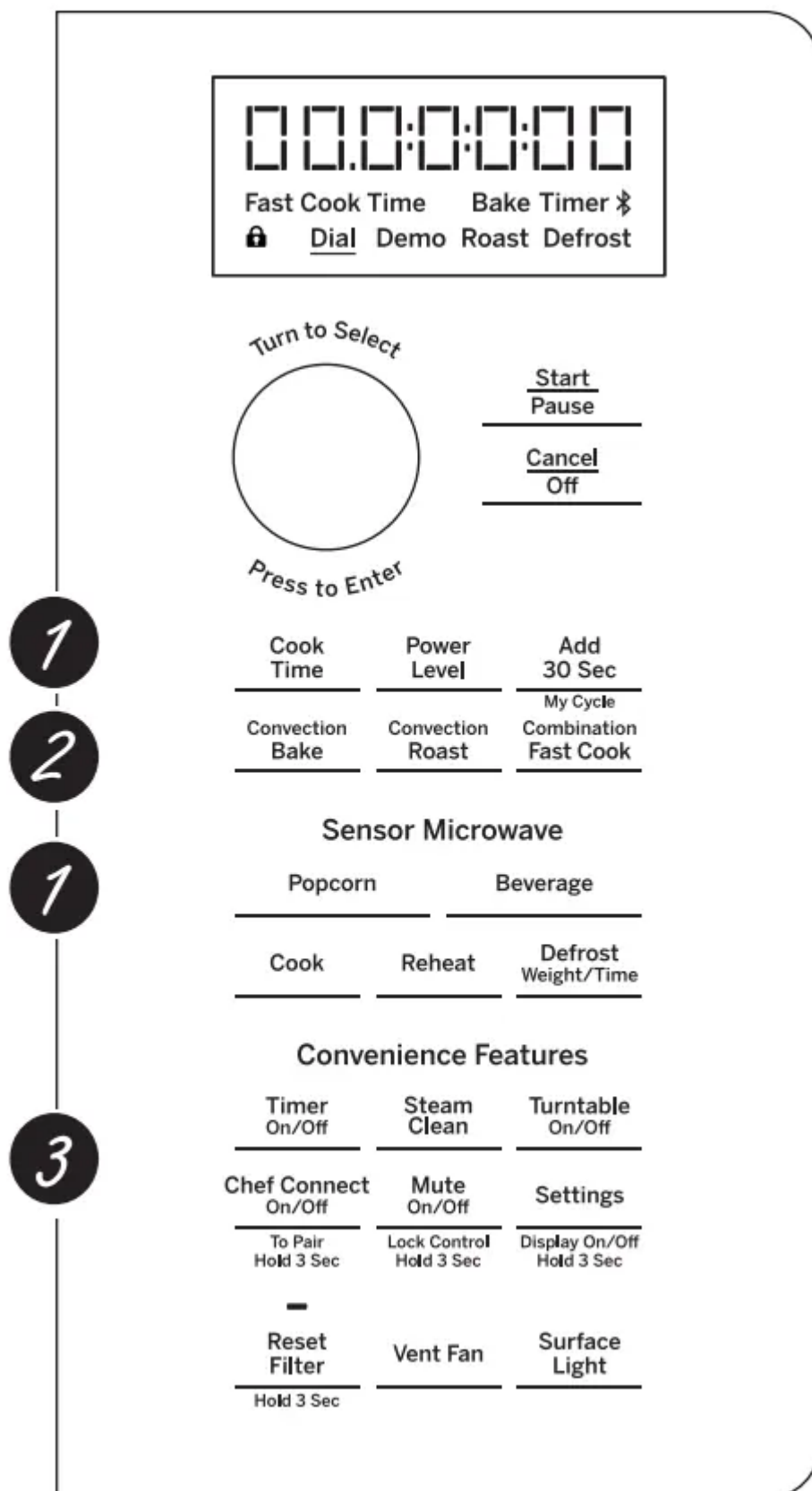

1. Microwave Cooking Time and Auto Features



Press	Turn and push dial to enter
Cook Time Press once (Cook Time I) to microwave any time between 15 seconds and 99 minutes. Press twice (Cook Time II) to change power levels automatically during cooking.	Amount of cooking time
Microwave Express cook/ Add 30 sec.	Starts immediately!
Defrost Press once (Weight Defrost) Press twice (Timer Defrost)	Food weight up to one pound Amount of defrosting time
Beverage	Starts immediately!
Power Level	Power level 1–10

Sensor Features

Press	Turn and push dial to enter	Option
Popcorn	Starts immediately!	more/less time
Reheat Turn Dial (Plate / Soup / Veggies / Pasta)	Starts immediately!	more/less time
Auto Cook	Food type	more/less time

2. Convection Baking or Convection Roasting

Press	Turn and push dial to enter
Convection Bake or Convection Roast	Oven temperature and cook time

3. Combination Fast Cooking

Press	Turn and push dial to enter
Combination Fast Cook	Oven temperature and cook time

Available cooking options.

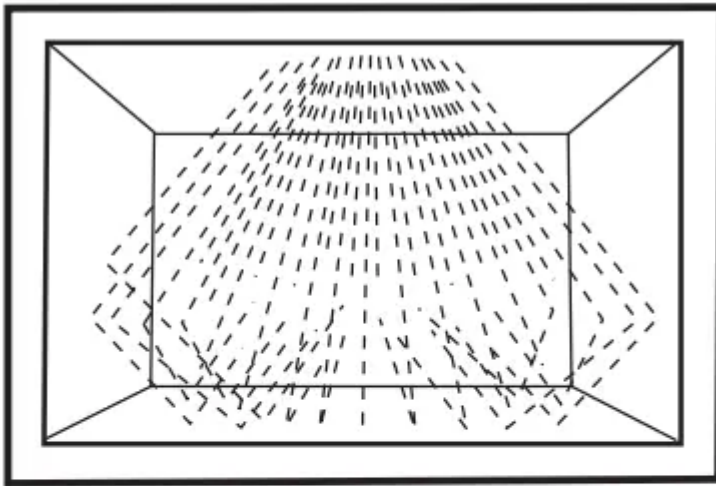

Do not use the shelves when microwave cooking.

Microwave Cooking

- Your oven uses microwave energy to cook by a set time or weight, or automatically by sensor.
- Sensor microwave works by detecting the increasing humidity released during cooking. The oven automatically adjusts the cooking time to various types and amounts of food.

Cooking Method

- Microwave energy is distributed evenly throughout the oven for thorough, fast cooking of food.

Heat Source

- Microwave energy

Heat Conduction

- Heat produced within food by instant energy penetration.

Benefits

- Fast, high efficiency cooking. Oven and surroundings do not get hot. Easy clean up

Convection Baking and Convection Roasting

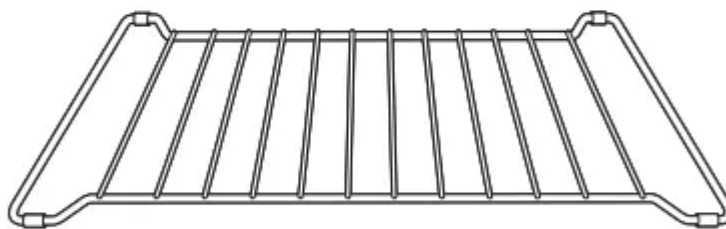
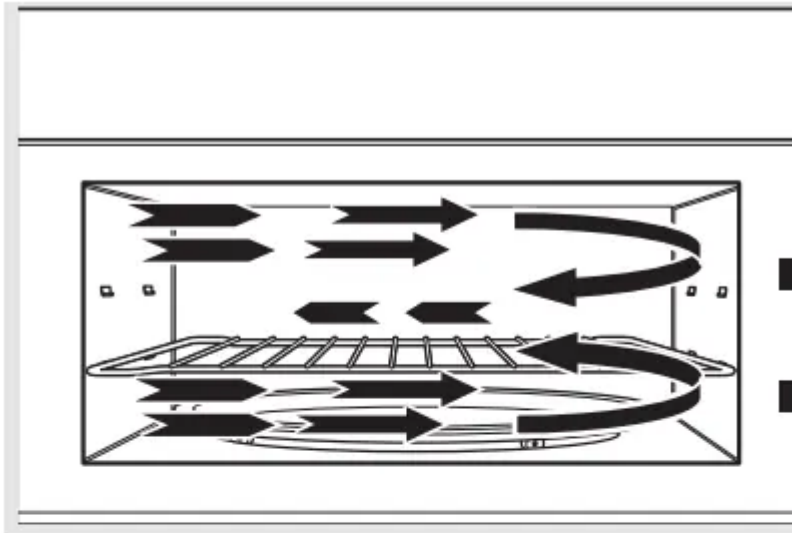

or

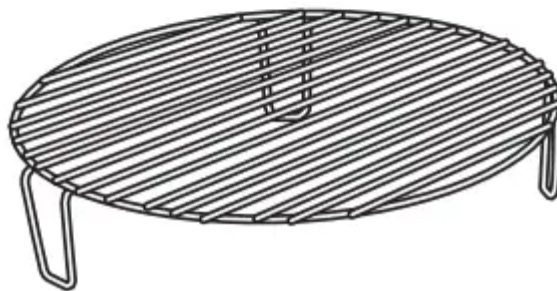

Always use the shelf when baking. For best results, use one shelf in the lower position.

- During baking or roasting, a heating element is used to raise the temperature of the air inside the oven. Any oven temperature from 225°F. to 425°F. may be programmed. A fan gently circulates this heated air throughout the oven, over and around the food, producing golden brown exteriors and rich moist interiors. This circulation of heated air is called convection.

- Because the heated air is kept constantly moving, not permitting a layer of cooler air to develop around the food, some foods cook faster than in regular oven cooking.

Cooking Method

- Hot air circulates around food to produce browned exteriors and seal in juices.

Heat Source

- Circulating heated air (Convection).

Heat Conduction

- Heat conducted from outside of food to inside.

Benefits

- Aids in browning and seals in flavor. Cooks some foods faster than regular ovens.

About the time and auto microwave features.

Using the Dial

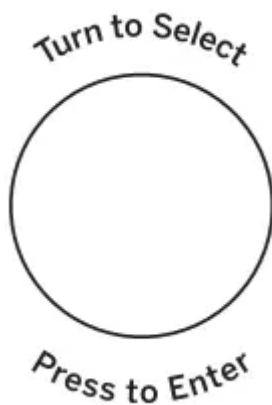

- You can make selections on the oven by turning the dial and pressing it to enter the selection.
- Pressing the dial can also be used in place of the Start/Pause button for quicker programming of the oven.

Cook Time (Do not use the shelves when microwave cooking.)



Cook Time I

Allows you to microwave for any time between 15 seconds and 99 minutes.

Power level 10 (High) is automatically set, but you may change it for more flexibility.

1. Press the Cook Time button.
2. Turn the dial to set the cook time and press the dial to enter.
3. Change power level if you don't want full power. (Press Power Level. Turn the dial to select. Press the dial to enter.)
4. Press the dial or the Start/Pause button to start cooking.

You may open the door during Cook Time to check the food. Close the door and press the dial or Start/Pause to resume cooking.

NOTE: You may change the cook time at any time during cooking by turning the dial. You may also change the power level by pressing the Power Level button.

Cook Time II

Lets you change power levels automatically during cooking. Here's how to do it:

1. Press the Cook Time button.
2. Turn the dial to set the first cook time and press the dial to enter.

3. Change the power level if you don't want full power. (Press Power Level. Turn the dial to select. Press the dial to enter.)
4. Press the Cook Time button again.
5. Turn the dial to set the second cook time and press the dial to enter.
6. Change the power level if you don't want full power. (Press Power Level. Turn the dial to select. Press the dial to enter.)
7. Press the dial or the Start/Pause button to start cooking.

At the end of Cook Time I, Cook Time II counts down.

NOTE: You may change the cook time at any time during cooking by turning the dial. You may also change the power level by pressing the Power Level button.

Add 30 Sec

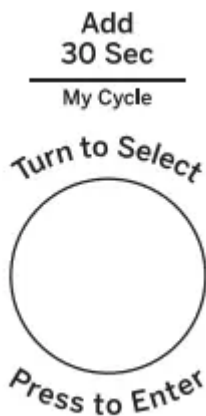

- This is a quick way to set and start cooking in 30 second blocks each time the Add 30 Second button is pressed. The cook time may be changed by turning the dial at any time during cooking.
- The power level will automatically be set at 10 and the oven will start immediately.
- The power level can be changed as time is counting down. Press the Power Level button, turn the dial and press to enter.

Weight Defrost (Do not use the shelves when microwave cooking.)

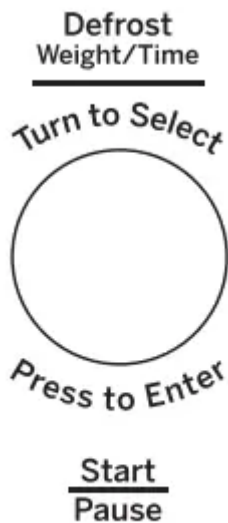

Weight Defrost automatically sets the defrosting times and power levels to give even defrosting results for meats, poultry and fish weighing up to one pound.

- Remove meat from package and place on PLFURZDYH VDIHGLVK
1. Press the Defrost button once.
 2. Turn the dial to the food weight, using the Conversion Guide at right. For example, dial .5 for .5 pounds (8 oz.) Press the dial to enter.
 3. Press the Start/Pause button to start defrosting.
 4. Turn the food over if the oven signals TURN FOOD OVER
- Remove defrosted meat or shield warm areas with small pieces of foil.
 - After defrosting, most meats need to stand 5 minutes to complete defrosting.

Conversion Guide

If the weight of food is stated in pounds and ounces, the ounces must be converted to tenths (.1) of a pound.

Weight of Food in Ounces	Enter Food Weight (tenths of a pound)
1–2	.1
3	.2
4–5	.3
6–7	.4
8	.5
9–10	.6
11	.7
12–13	.8
14–15	.9

Time Defrost (Do not use the shelves when microwave cooking.)

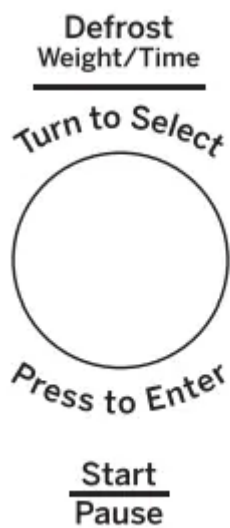

Use Time Defrost to defrost for a selected length of time.

1. Press the Defrost button twice.
2. Turn the dial to select the time you want. Press the dial to enter.
3. Press the Start/Pause button to start defrosting.
4. Turn the food over if the oven signals TURN FOOD OVER.

You may change the defrost time at any time during defrosting by turning the dial. Power level is automatically set at 3, but can be turning the dial

Power level is automatically set at 3, but can be changed. You can defrost small items quickly by raising the power level after entering the time. Power Level 7 cuts the total defrosting time in about half; Power Level 10 cuts the total time to approximately 1/3. However, food will need more frequent attention than usual

A dull thumping noise may be heard during defrosting. This is normal when oven is not operating at High power.

Defrosting Tips

- Foods frozen in paper or plastic can be defrosted in the package. Closed packages should be slit, pierced or vented AFTER food has partially defrosted. Plastic storage containers should be partially uncovered.
- Family- size, prepackaged frozen dinners can be defrosted and microwaved. If the food is in a foil container, transfer it to a microwave-safe dish
- Foods that spoil easily should not be allowed to sit out for more than one hour after defrosting. Room temperature promotes the growth of harmful bacteria.
- For more even defrosting of larger foods, such as roasts, use Auto Defrost. Be sure large meats are completely defrosted before cooking.
- When defrosted, food should be cool but softened in all areas. If still slightly icy, return to the microwave very briefly, or let it stand a few minutes.

Power Level

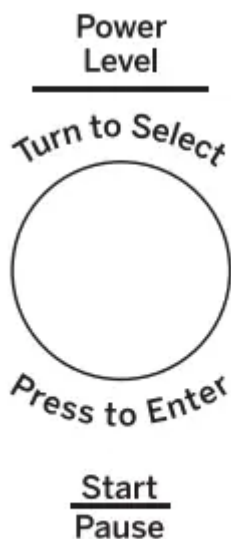

The power level may be entered or changed immediately after entering the time for Cook Time, Time Defrost or Combination Speed Cook. The power level may also be changed during time countdown.

1. First, follow directions for Cook Time, Time Defrost or Combination Speed Cook.
2. Press the Power Level button.
3. Turn the dial clockwise to increase and counterclockwise to decrease the power level. Press the dial to enter.
4. Press the Start/Pause button to start cooking.

Variable power levels add flexibility to microwave cooking. The power levels on the microwave oven can be compared to the surface units on a range. Each power level gives you microwave energy a certain percent of the time. Power Level 7 is microwave energy 70% of the time. Power Level 3 is energy 30% of the time. Most cooking will be done on High (Power Level 10) which gives you 100% power. Power Level 10 will cook faster but food may need more frequent stirring, rotating or turning over.

A lower setting will cook more evenly and need less stirring or rotating of the food. Some foods may have better flavor, texture or appearance if one of the lower settings is used. Use a lower power level when cooking foods that have a tendency to boil over, such as scalloped potatoes.

Rest periods (when the microwave energy cycles off) give time for the food to “equalize” or transfer heat to the inside of the food. An example of this is shown with Power Level 3- the defrost cycle. If microwave energy did not cycle off, the outside of the food would cook before the inside was defrosted.

Here are some examples of uses for various power levels:

- High 10: Fish, bacon, vegetables, heating liquids
- Med-High 7: Gentle cooking of meat and poultry; baking casseroles and reheating.
- Medium 5: Slow cooking and tenderizing for stews and less tender cuts of meat.
- Low 2 or 3: Defrosting; simmering; delicate sauces.
- Warm 1: Keeping food warm; softening butter

Microwave terms.

Term	Definition
Arcing	Arcing is the microwave term for sparks in the oven. Arcing is caused by: <ul style="list-style-type: none">• the metal shelf being installed incorrectly and touching the microwave walls.• metal or foil touching the side of the oven.• foil that is not molded to food (upturned edges act like antennas).• metal such as twist - ties, poultry pins, gold-rimmed dishes• recycled paper towels containing small metal pieces.• the turntable ring support being installed incorrectly.
Covering	Covers hold in moisture, allow for more even heating and reduce cooking time. Venting plastic wrap or covering with wax paper allows excess steam to escape.
Shielding	Covers hold in moisture, allow for more even heating and reduce cooking time. Venting plastic wrap or you use small strips of foil to shield thin parts, such as the tips of wings and legs on poultry which would cook before larger parts.
Standing Time	When you cook with regular ovens, foods such as roasts or cakes are allowed to stand to finish cooking or to set. Standing time is especially important in microwave cooking. Note that a microwaved cake is not placed on a cooling rack.
Venting	After covering a dish with plastic wrap, you vent the plastic wrap by turning back one corner so excess steam can escape.

About the sensor microwave features.

Humidity Sensor

What happens when using the Sensor Features:

The Sensor Features detect the increasing humidity released during cooking. The oven automatically adjusts the cooking time to various types and amounts of food.

Do not use the Sensor Feature twice in succession on the same food portion-it may result in severely overcooked or burnt food. If food is undercooked after the countdown, use Cook Time for additional cooking time.

NOTE: Sensor features will not operate when the oven is hot. If one of the sensor cooking buttons is pressed when the temperature inside the oven is greater than 200°F, "OVEN TOO HOT FOR SENSOR COOKING---USING ALTERNATE METHOD" will be displayed. The oven will

automatically change to cook by time (follow the directions in the display) or once the oven is cool enough, the sensor features will function normally.



Covered



Vented



Dry off dishes so they don't mislead the sensor.

- The proper containers and covers are essential for best sensor cooking

Always use microwave-safe containers and cover them with lids or vented plastic wrap. Never use tight sealing plastic containers—they can prevent steam from escaping and cause food to overcook.

- Be sure the outside of the cooking containers and the inside of the microwave oven are dry before placing food in the oven. Beads of moisture turning into steam can mislead the sensor

Cook (Do not use the shelves when microwave cooking.)

Cook

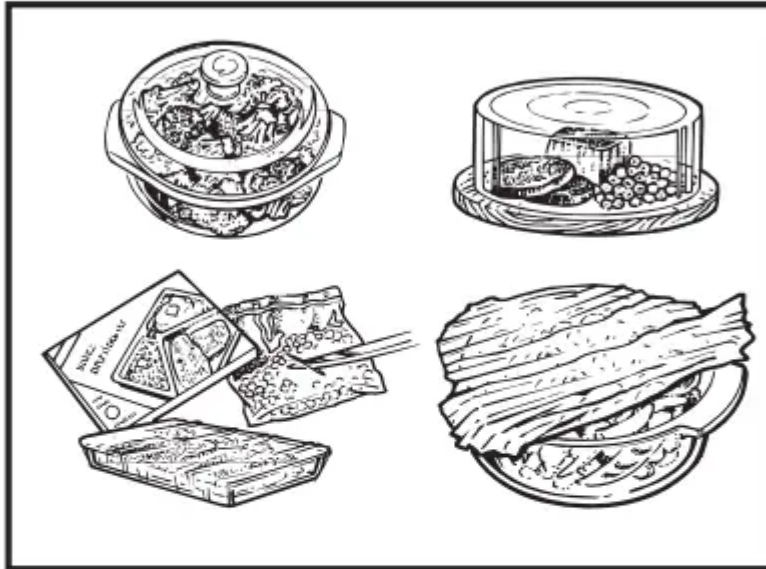

Because most cooking containers must be covered during Cook, this feature is best with foods that you want to steam or retain moisture.

NOTE: Use of the metal shelf with Cook is not recommended.

Recommended Foods

- A wide variety of foods including meats, fish and vegetables can be cooked using this feature.

Foods not recommended

- Foods that must be cooked uncovered. foods that require constant attention, foods that require addition of ingredients during cooking and foods calling for a dry look or crisp surface after cooking should not be cooked using this feature. It is best to Cook Time them.

Popcorn (Do not use the shelves when microwave cooking.)

Popcorn

Use only with prepackaged microwave popcorn weighing 1.5 to 3.5 ounces.

NOTE: Do not use this feature twice in succession on the same food portion-it may result in severely overcooked or burnt food.

To use the Popcorn feature:

1. Follow package instructions, using Cook Time if the package is less than 1.5 ounces or larger than 3.5 ounces. Place the package of popcorn in the center of the turntable.
2. Press the Popcorn button. The oven starts immediately.

If you open the door while POPCORN SENSOR is displayed, an error message will appear. Close the door, press Cancel/Off and begin again.

If food is undercooked after the countdown, use Cook Time for additional cooking time.

How to Adjust the Automatic Popcorn Setting to Provide a Shorter or Longer Cook Time

- If you find that the brand of popcorn you use underpops or overpops consistently, you can add or subtract 20–30 seconds to the automatic popping time.
- To subtract or add time for sensor cook, turn the dial when the time appears.

Beverage (Do not use the shelves when microwave cooking.)

Beverage

- The Beverage feature heats beverages from 6 to 12 ounces.
- Press the Beverage button. Then oven start immediately.
- Drinks heated with the Beverage feature may be very hot. Remove the container with care.

Reheat (Do not use the shelves when microwave cooking.)

Reheat

The Reheat feature reheats servings of previously cooked foods or a plate of leftovers

1. Place the cup of liquid or covered food in the oven. Press Reheat and choose food type.
2. The oven signals when steam is sensed and the time remaining begins counting down.

Do not open the oven door until time is counting down. If the door is opened, close it and press Start/ Pause immediately.

After removing food from the oven, stir, if possible, to even out the temperature. Reheated foods may have wide variations in temperature. Some areas of food may be extremely hot.

If food is not hot enough after the countdown use Cook Time for additional reheating time.

Some Foods Not Recommended for Use With Reheat

It is best to use Cook Time for these foods:

- Bread products.
- Foods that must be reheated uncovered.
- Foods that need to be stirred or rotated.
- Foods calling for a dry look or crisp surface after reheating.

How to Adjust the Oven's Automatic Settings for a Shorter or Longer Time

- To subtract 10% from the automatic cooking time: Within the first 30 seconds after the oven starts, turn the dial counterclockwise, until a minus (“-”) sign appears, and press to enter.
- To add 10% to the automatic cooking time: Within the first 30 seconds after the oven starts, turn the dial clockwise, until a plus (“+”) sign appears, and press to enter.

Cook (Do not use the shelves when microwave cooking.)

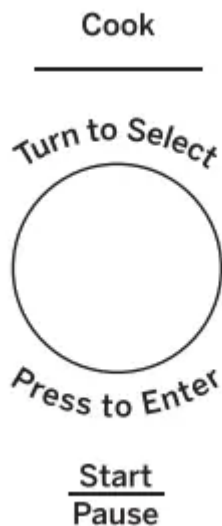

NOTE: Do not use this feature twice in succession on the same food portion- it may result in severely overcooked or burnt food.

1. Place covered food in the oven and close the door. Press the Cook button. ENTER FOOD TYPE appears in the display.
2. Turn the dial to the desired food type. Press to enter.

See the Sensor Food Type Guide below for specific foods and instructions.

The oven starts immediately.

NOTE: If the door was open while the control was being set, close the door and press the Start/Pause button to begin cooking.

If food is undercooked after the countdown, use Cook Time for additional cooking time.

Do not open the oven door before the countdown time is displayed-steam escaping from the oven can affect cooking performance from the oven can affect cooking performance. If the door is opened, close the door and press Start/Pause immediately.

If ground meat was selected, the oven may signal you to drain and stir the meat. Open the door, drain the meat and close the door. Press the Start/Pause button if necessary to resume cooking.

Cooking Tips

- When oven signals and countdown time is displayed, the door may be opened for stirring, turning or rotating food. To resume cooking, close the door and press Start/Pause.
- Match the amount of food to the size of container. Fill containers at least 1/2 full.
- Be sure outside of container and inside of oven are dry.
- After completion of Cook cycle, if food needs additional cooking, return food to oven and use Cook Time to finish cooking

How to Adjust the Oven's Automatic Settings for a Shorter or Longer Cook Time (Not available for all food types)

- To subtract 10% from the automatic cooking time: Within the first 30 seconds after the oven starts, turn the dial counterclockwise, until a minus (“-”) sign appears, and press to enter.
- To add 10% to the automatic cooking time: Within the first 30 seconds after the oven starts, turn the dial clockwise, until a plus (“+”) sign appears, and press to enter.

Sensor Food Type Guide

Food Type	Servings	Serving Size	Comments
Chicken	Bone-In Boneless	2 to 8 pieces	Use oblong, square or round dish. Cover with vented plastic wrap.
Fish	—	4 to 16 oz.	Use oblong, square or round dish. Cover with vented plastic wrap.
Ground Meat (Beef, Pork, Turkey)	—	8 to 32 oz.	Use round casserole dish. Crumble meat into dish. Cover with vented plastic wrap.
Potatoes	—	8 to 32 oz.	Pierce skin with fork. Arrange in a star pattern in center of turntable.
Vegetables	Canned	4 to 16 oz.	Use microwave-safe casserole or bowl. Cover with lid or vented plastic wrap.
Vegetables	Fresh	4 to 16 oz.	Use microwave-safe casserole or bowl. Add 2 tablespoons water for each serving. Cover with lid or vented plastic wrap.
Vegetables	Frozen	4 to 16 oz.	Use microwave-safe casserole or bowl. Follow package instructions for adding water. Cover with lid or vented plastic wrap.

About the baking and roasting features.

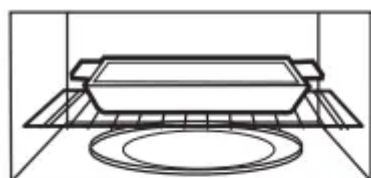

Correct shelf position



Incorrect shelf position

- Baking or roasting uses a heating element to raise the temperature of the air inside the oven. Any oven temperature from 225°F to 425°F may be set. A fan gently circulates this heated air throughout the oven, over and around the food, producing golden brown exteriors and rich, moist interiors. This circulation of heated air is called convection.

- Because the heated air is kept constantly moving, not permitting a layer of cooler air to develop around the food, some foods cook faster than in regular oven cooking.

For Best Results...

- Use one shelf in the lower position and leave at least a 1-inch gap between the cooking dish and the sides of the oven. For two-level cooking only, use both shelves. Use the circular rack if possible. If the food is too long to turn (casseroles, lasagnas, etc.) or too tall to fit (roasts, etc.), we recommend using the rectangular rack in the lower position.
- The shelf is required for good air circulation and even browning
- See the Cookware Tips section for information on suggested cookware.

Convection Bake or Convection Roast with Preheat

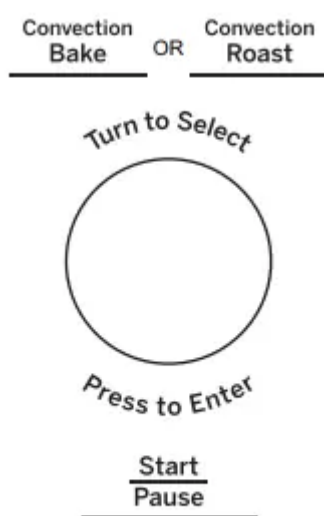

1. Press the Convection Bake or Convection Roast button.
2. Turn the dial to set the oven temperature and press dial to enter. Do not enter bake time now. (The cook time will be entered later, after the oven is preheated.) See the Convection Bake Offset section below.
3. Press the dial or the Start/Pause button to start preheating.
4. When the oven is preheated, it will signal. If you do not open the door within 1 hour, the oven will turn off automatically.
5. Open the oven door and, using caution, place the food in the oven.
6. Close the oven door. Turn the dial to set the cook time and press the dial or Start/Pause to start cooking.
7. When cooking is complete, the oven will signal and turn off.

NOTE: You may change the cook time at any time during cooking by turning the dial.

You may change the oven temperature at any time during cooking by pressing the Power Level button. Turn the dial to set the oven temperature and press the dial to enter.

To view the cook time and oven temperature during cooking, press the Bake button.

Convection Bake or Convection without Preheating

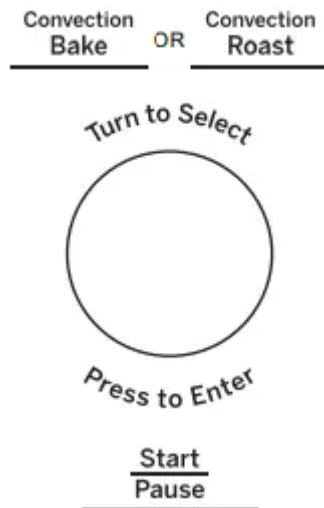

1. If your recipe does not require preheating press the Convection Bake or Convection Roast button. See the Convection Bake Offset section below.
2. Turn the dial to set the oven temperature and press to enter.
3. Turn the dial to set the cook time and press to enter.
4. Press the dial or the Start/Pause button to start the oven.

NOTE: You may change the cook time at any time during cooking by turning the dial.

You may change the oven temperature at any time during cooking by pressing the Power Level button. Turn the dial to set the oven temperature and press the dial to enter.

To view the cook time and oven temperature during cooking, press the Convection Bake button.

Convection Bake Offset

- When using Convection Bake, the Convection Bake Offset feature will automatically convert entered regular baking temperatures to convection baking temperatures.
- This feature is activated so that the display will show OFFSET ON and the actual converted (reduced) temperature. For example, if you enter a regular recipe temperature of 350°F and press the Start/Pause button, the display will show the converted temperature of 325°F.
- This feature can be turned off in the Settings menu. See the Convection Bake Offset Selection in the About the other features section.

NOTE: If convection baking and the Convection Bake Offset feature is turned off, reduce the oven temperature 25°F from the recipe to prevent overbrowning on the top of baked goods.

About the Fast Cook feature.

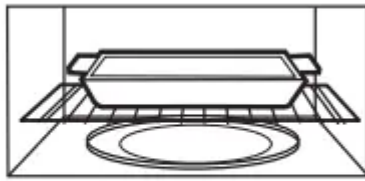

Correct shelf position



Incorrect shelf position

Fast Cook offers the best features of microwave energy and convection cooking. Microwaves cook food fast and convection circulation of heated air browns foods beautifully. Any oven temperature from 225°F to 425°F may be set.

For Best Results...

- Use one shelf in the lower position and leave at least a 1-inch gap between the cooking dish and the sides of the oven.
- The shelf is required for good air circulation and even browning
- See the Cookware Tips section for information on suggested cookware.
- See the Best Method of Cooking section to determine the which foods are appropriate to cook using Fast Cook.

Fast Cook with Preheat

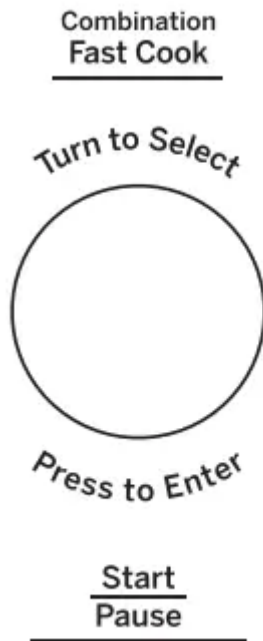

1. Press the Combination Fast Cook button.
2. Turn the dial to set the oven temperature and press dial to enter. Do not enter Fast Cook cook time now. (The cook time will be entered later, after the oven is preheated.)
3. Press the dial or the Start/Pause button to start preheating.
4. When the oven is preheated, it will signal. If you do not open the door within 1 hour, the oven will turn off automatically.
5. Open the oven door and, using caution, place the food in the oven.
6. Close the oven door. Turn the dial to set the cook time and press to enter. Press the dial or the Start/Pause button to start cooking.
7. When cooking is complete, the oven will signal and turn off.

NOTE: You may change the cook time at any time during cooking by turning the dial.

You may change the oven temperature and microwave power level at any time during cooking by pressing the Power Level button. Turn the dial to set the oven temperature and press the dial to enter. Then, turn the dial to set microwave power level 1 through 4 and press the dial to enter. The default power level is 4.

To view the cook time and oven temperature during cooking, press the Fast Cook button.

- Check the Cookware Tips section for correct cookware when using Fast Cook.
- Do not use metal cookware with Fast Cook.
- Reduce the recipe cook time by 25%.
- See the Best Method of Cooking section to determine the which foods are appropriate to cook using Fast Cook

Fast Cook without Preheat

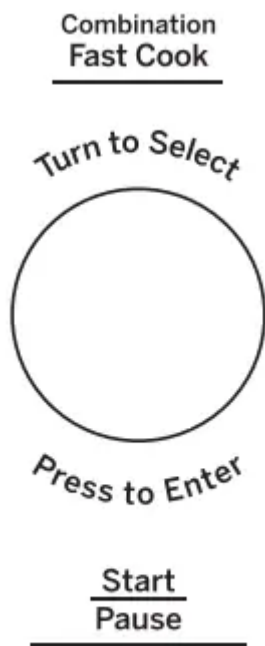

1. If your recipe does not require preheating press the Fast Cook button.
2. Turn the dial to set the oven temperature and press to enter.
3. Turn the dial to set the cook time and press to enter.
4. Press the dial or the Start/Pause button to start the oven.

NOTE: You may change the cook time at any time during cooking by turning the dial.

You may change the oven temperature and microwave power level at any time during cooking by pressing the Power Level button. Turn the dial to set the oven temperature and press the dial to enter. Then, turn the dial to set microwave power level 1 through 4 and press the dial to enter. The default power level is 4.

To view the cook time and oven temperature during cooking, press the Fast Cook button.

NOTE:

- Some recipes call for preheating.
- Check the Cookware Tips section for correct cookware when using Fast Cook
- Do not use metal cookware with Fast Cook.
- See the Best Method of Cooking section to determine the which foods are appropriate to cook using Fast Cook.

Cookware tips.

Convection Bake or Roast

- Metal Pans are recommended for all types of baked products, but especially where browning is important.
- Dark or dull finish metal pans are best for breads and pies because they absorb heat and produce crisper crust.
- Shiny aluminum pans are better for cakes, cookies or muffins because they reflect heat and help produce a light tender crust.
- Glass or Glass-Ceramic casserole or baking dishes are best suited for egg and cheese recipes due to the cleanability of glass.

Combination Fast Bake

- Glass or Glass-Ceramic baking containers are recommended. Be sure not to use items with metal trim as it may cause arcing (sparking) with oven wall or oven shelf. This can damage the cookware, the shelf or the oven.
- Heat-Resistant Plastic microwave cookware (safe to 450°F) may be used, but it is not recommended for foods requiring all-around browning, because the plastic a poor conductor of heat.

<i>Cookware</i>	<i>Microwave</i>	<i>Convection Bake or Roast</i>	<i>Combination Fast Cook</i>
<i>Heat-Resistant Glass, Glass-Ceramic (Pyrex®, Fire King®, Corning Ware®, etc.)</i>	Yes	Yes	Yes
<i>Metal</i>	No	Yes	No
<i>Non Heat-Resistant Glass</i>	No	No	No
<i>Microwave-Safe Plastics</i>	Yes	No	Yes*
<i>Plastic Films and Wraps</i>	Yes	No	No
<i>Paper Products</i>	Yes	No	No
<i>Straw, Wicker and Wood</i>	Yes	No	No

* Use only microwave cookware that is safe to 450°F.

Select the best method of cooking.

Use the following guide to select the best method of cooking. Recipes can be adapted using the guidelines below to determine the appropriate cooking mode.

Foods	Microwave	Bake	Roast	Fast Cook
Appetizers				
Dips and Spreads	✓			
Pastry Snacks	✓	✓		✓
Beverages	✓			
Sauces and Toppings	✓			
Soups and Stews	✓			
Meats				
Defrosting	✓			
Roasting			✓	✓
Poultry				
Defrosting	✓			
Roasting	✓		✓	✓
Fish and Seafood				
Defrosting	✓			
Cooking	✓	✓		✓
Casseroles	✓	✓		✓
Eggs and Cheese				
Scrambled, Omelets	✓	✓		
Quiche, Souffle		✓		✓
Vegetables, (fresh)	✓			
Breads				
Muffins, Coffee Cake	✓	✓		
Quick		✓		
Yeast		✓		
Desserts				
Cakes, Layer and Bundt		✓		
Angel Food and Chiffon		✓		
Custard and Pudding	✓			
Bar Cookies	✓	✓		
Fruit	✓			
Pies and Pastry		✓		
Candy	✓			
Blanching Vegetables	✓			
Frozen Convenience Foods	✓	✓		✓

About the other features.

Cooking Complete Reminder

- To remind you that you have food in the oven, the oven will display YOUR FOOD IS READY and beep once a minute until you either open the oven door or press the Cancel/Off button.

Start/Pause

Start
Pause

- In addition to starting many functions, Start/ Pause allows you to stop cooking without opening the door or clearing the display.

Cancel/Off

Cancel Off

- Press the Cancel/Off button to stop and cancel cooking at any time.

Timer On/Off

Timer On/Off

The Timer operates as a minute timer and can be used at any time, even when the oven is operating.

1. Press the Timer button.
2. Turn the dial to select the minutes. Press the dial to enter.
3. Turn the dial to select the seconds. Press the dial to enter
4. Press the dial or Timer to start.

To cancel, press the Timer button.

When time is up, the oven will signal. To turn off the timer signal, press Timer.

NOTE: The TIMER indicator will be lit while the timer is operating

Steam Clean

Steam Clean

1. Press the Steam Clean button.
2. Put steam bowl with 1/4 cup of water.
3. Press the dial or Start/Pause to start.

Turntable

Turntable On/Off

For best cooking results, leave the turntable on. It can be turned off for large dishes.

1. Press the Turntable On/Off button..

2. Turn the dial to select on/off. Press the dial to enter.

Sometimes the turntable can become too hot to touch.

Be careful touching the turntable during and after cooking

Mute On/Off



- You can control sound using Mute On/Off button.

Control Lock-Out

- You may lock the control panel to prevent the oven from being accidentally started during cleaning or being used by children.
- To lock or unlock the controls, press and hold seconds. When the control panel is locked, CONTROL LOCKED will be displayed briefly anytime a button or dial is pressed.

Set Clock

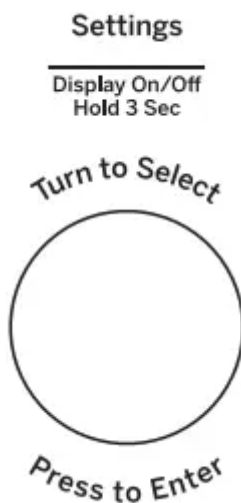

1. Press the Settings button and turn the dial to select Clock Set. Press the dial to enter..
2. Turn the dial to set hours. Press the dial to enter.
3. Turn the dial to set minutes. Press the dial to enter.

Clock Mode

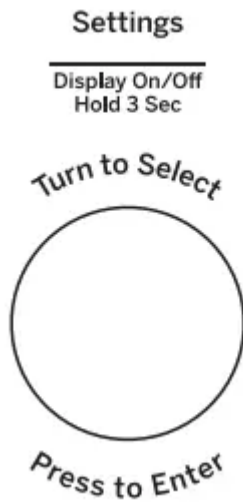

Clock Mode can be set for 12 hours and 24 hours.

1. Press the Settings button and turn the dial to select Clock Mode. Press the dial to enter.
2. Turn the dial to set 12 hours or 24 hours Clock Mode. Press enter to activate.

Display Speed

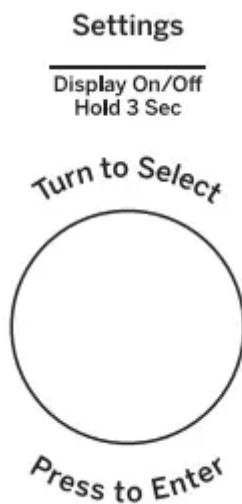

Display Speed can be adjusted for Slow, Normal, or Fast

1. Press the Settings button and turn the dial to select Display Speed. Press the dial to enter.
2. Turn the dial to set Display Speed (Slow, Normal, Fast). Press enter to activate.

Sound Level

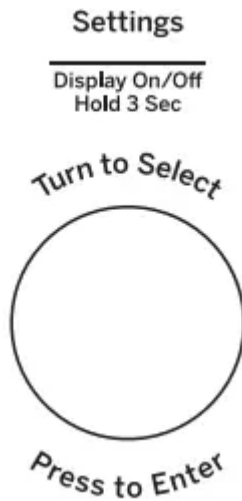

Sound Level can be adjusted for Mute, Low, Normal or Loud

1. Press the Settings button and turn the dial to select Sound Level. Press the dial to enter.
2. Turn the dial to set Sound Level (Mute, Low, Normal, or Loud). Press enter to activate.

Surface Light Sync

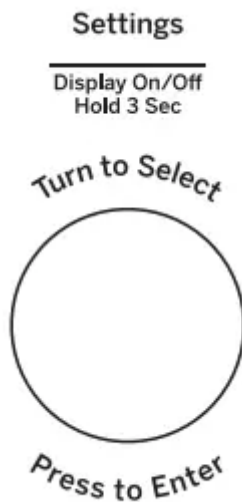

1. Press the Settings button and turn the dial to select Surface Light Sync. Press the dial to enter.
2. Turn the dial to select sync mode (Off, Low, High).
3. Press the dial to activate.

Vent Fan Sync

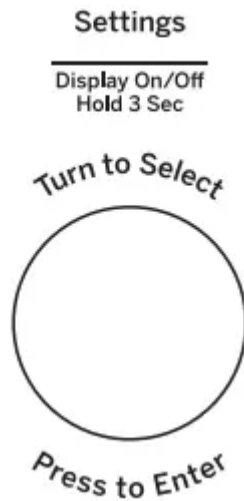

1. Press the Settings button and turn the dial to select Vent Fan Sync. Press the dial to enter.
2. Turn the dial to select Vent Fan Sync mode (Off, Low, Medium or High).
3. Press the dial to activate.

Sync Auto Off

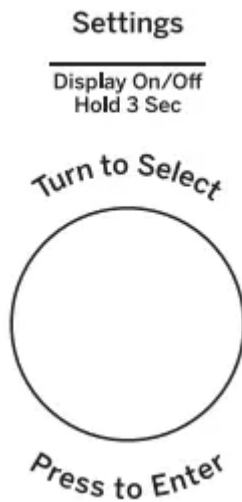

1. Press the Settings button and turn the dial to select Sync Auto Off Press the dial to enter.
2. Turn the dial to select Sync Auto Off (up to 15 minutes and manual). Press enter to activate.

Convect Bake Offset

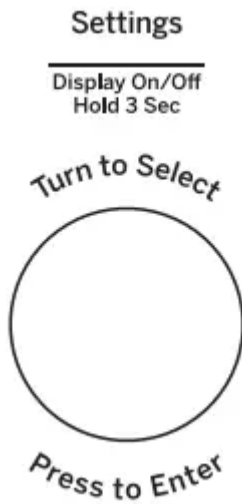

1. Press the Settings button and turn the dial to select Convect Bake Offset. Press the dial to enter.
2. Turn the dial to select Convect Bake Offset On/Off Press enter to activate.

Bake Temp Adjust

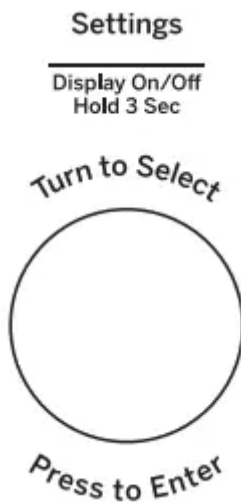

1. Press the Settings button and turn the dial to select Bake Temp Adjust Press the dial to enter.
2. Turn the dial to select Bake Temp Adjust range from - 25 degree to 25 degree. Press enter to activate.

Filter Replace Reminder

Reset Filter

Hold 3 Sec

- When the Filter Replace light turned on, replace filter and press Reset Filter and hold for 3 seconds to reset.
- A filter is only needed for models that are not vented to the outside.

Surface Light

Surface Light

- Press Surface Light once for bright light, twice for the night light or a third time to turn the light off.

Vent Fan

Vent Fan

- The vent fan removes steam and other vapors from surface cooking.
- Press Vent Fan once for high fan speed, twice for medium fan speed, three times for low fan speed or a fourth time to turn the fan off.

NOTE: The FAN indicator will be lit while the fan is operating

Automatic Fan

- An automatic fan feature protects the microwave from too much heat rising from the cooktop below it. It automatically turns on if it senses too much heat.
- If you have turned the fan on you may find that you cannot turn it off. The fan will automatically turn off when the internal parts are cool. It may stay on for 30 minutes or more after the cooktop and microwave controls are turned off.

Add 30 Sec

**Add
30 Sec**

My Cycle

The Add 30 Sec button can be used in 2 ways.

- It will add 30 seconds to the time counting down each time it is pressed.
- It can be used as a quick way to select 30 seconds of cook time. 30 seconds is the default time. It can be changed in Settings under My Cycle.

My Cycle

The Add 30 Sec button can be adjusted to the My Cycle feature.



1. Press the Settings button and turn the dial to select My Cycle. Press the dial to enter.
2. Turn the dial to select time (from 5 Sec to 60 Sec) and press the dial to complete the setting

Chef Connect

Chef Connect
On/Off

To Pair
Hold 3 Sec

Use the Chef Connect feature for connecting your microwave to a GE range to sync your vent fan, cooktop surface lights and clock via Bluetooth technology.

1. You must have a Chef Connect enabled range. To pair your microwave for the first time, initiate the Chef Connect process on the GE range. Refer to the range owner's manual for instructions
2. On the microwave, hold Chef Connect button for 3 seconds. The Bluetooth icon  on the display will start flashing as the microwave starts to search and pair with your GE Range. The icon  will remain ON after pairing successfully. If a GE Range is not found within 2 minutes during search mode the microwave will stop searching and the Bluetooth icon  will turn OFF. On initial setup, the setup protocol will start. If the Chef Connect feature is enabled the default settings are as follows:
 - Display clock sync: ON
 - Auto surface light: ON (HIGH setting)

- Auto vent fan: OFF
 - Auto off: 15 minutes
3. Turn the dial to select surface light Sync On/Off. Press the dial to confirm. If on, it allows the microwave surface lights to turn on at HIGH level automatically when the paired range's cooktop burner turns ON. If OFF, the microwave surface lights will not automatically turn on when a cooktop burner turns on.
 4. Turn the dial to select Vent Fan Sync ON/ OFF. Press the dial to confirm. If ON, it allows the microwave vent fan to turn on at LOW speed automatically when the paired range's cooktop burner turns on. If OFF, the vent fan will turn ON automatically when a cooktop burner is Pairing is now complete, the Chef Connect feature is now on.

Note: If there is no sync option selected during set up, 5 minutes after icon  turns ON, the units will return to stand-by mode and use the default settings.

After completing the setting per above steps, your microwaves vent fan and surface light could be set to turn on automatically when the cooktop burner is turned on. The cooktop and range clock display will be synced to display the same time. The vent fan and cooktop light will be set to automatically turn off 15 minutes after the cooktop burner is turned OFF.

If desired, the light, fan, and auto off settings can now be changed using option in Settings.

Press Chef Connect once to temporarily turn OFF communication between the microwave and range. Press again to turn communication back ON. The icon  will illuminate when ON.

In the case of an unintended disconnect such as lost power to the microwave or range the connection will remain after power resumed. For very short power interruptions, the power may need to be reset in order to reconnect

Note: To unpair the microwave from the range, press and hold the Chef Connect button on the microwave for 3 seconds. The Bluetooth icon will start to flash. Press cancel or wait 2 minutes for the flashing to stop. You may need to unpair when the GE range is replaced or serviced.

Care and cleaning of the oven.

Helpful Hints



- An occasional thorough wiping with a solution of baking soda and water keeps the inside fresh.
- Be sure the power is off before cleaning any part of this oven.

How to Clean the Inside

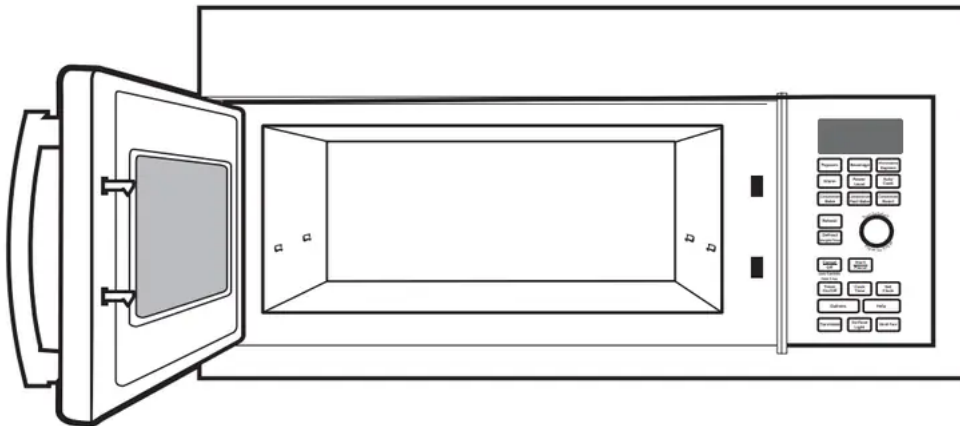

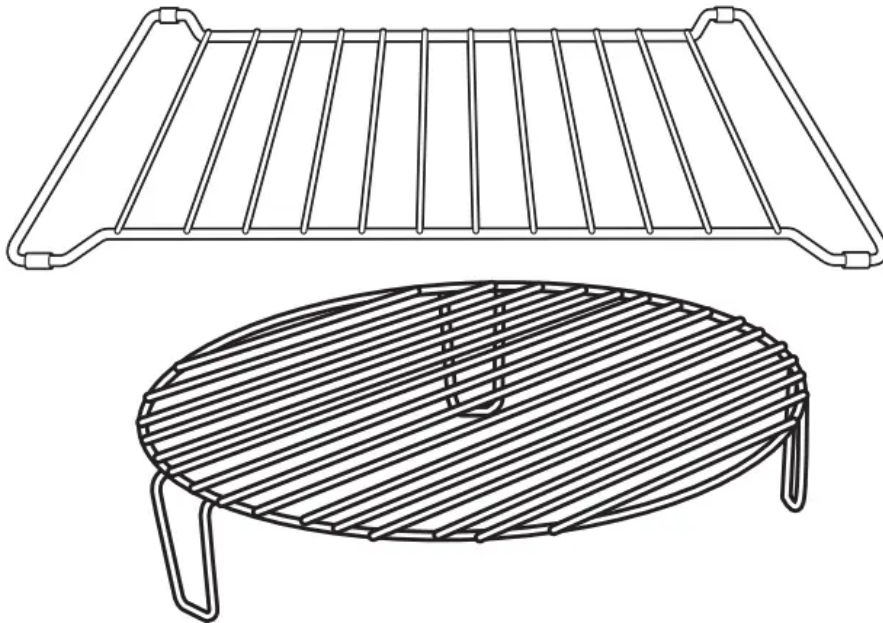

Walls, Floor, Inside Window, Metal and Plastic Parts on the Door

- Some spatters can be removed with a paper towel, others may require a damp cloth. Remove greasy spatters with a sudsy cloth, then rinse with a damp cloth. Do not use abrasive cleaners or sharp utensils on oven walls.
- Never use a commercial oven cleaner on any part of your microwave.

Removable Turntable and Turntable Support

- To prevent breakage, do not place the turntable into water just after cooking. Wash it carefully in warm, sudsy water or in the dishwasher. The turntable and support can be broken if dropped. Remember, do not operate the oven in the microwave mode without the turntable and support seated and in place.

Shelves

- Clean with mild soap and water or in the dishwasher.
- Do not clean in a self-cleaning oven.

How to Clean the Outside

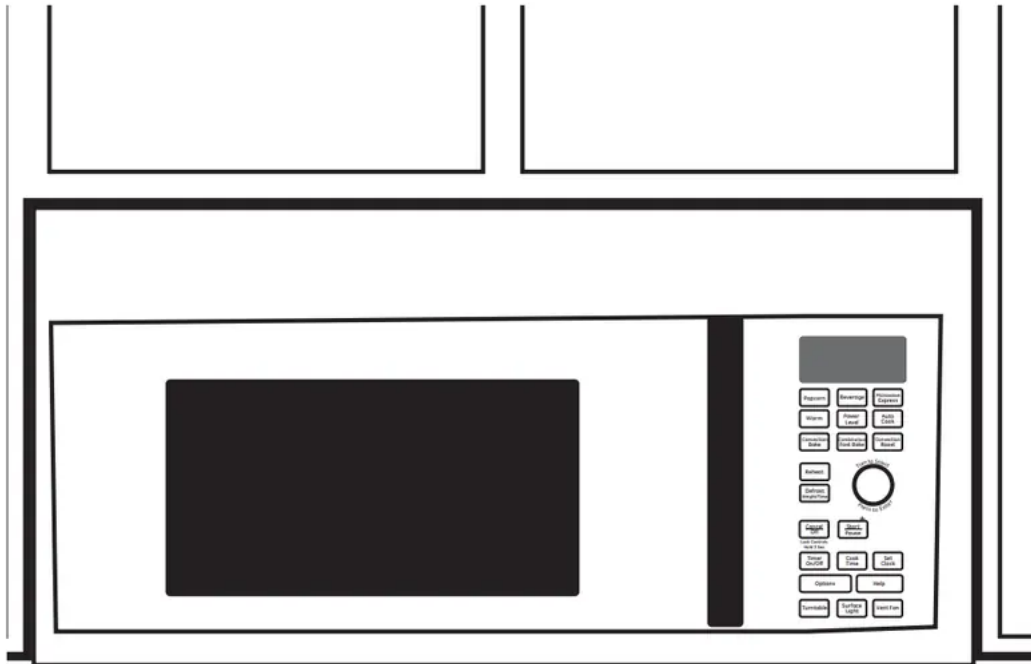

- We recommend against using cleaners with ammonia or alcohol, as they can damage the appearance of the microwave oven. If you choose to use a common household cleaner, first apply the cleaner directly to a clean cloth, then wipe the soiled area.
- Case: Clean the outside of the microwave with a sudsy cloth. Rinse and then dry. Wipe the window clean with a damp cloth.
- Control Panel: Wipe with a damp cloth. Dry thoroughly. Do not use cleaning sprays, large amounts of soap and water, abrasives or sharp objects on the panel - they can damage it. Some paper towels can also scratch the control panel.
- Door Panel: Before cleaning the front door panel, make sure you know what type of panel you have. Refer to the eighth digit of the model number. "S" is stainless steel, "L" is CleanSteel and "B", "W" or "C" are plastic colors.
- Stainless Steel (on some models): The stainless steel panel can be cleaned with Stainless Steel Magic or a similar product using a clean, soft cloth. Apply stainless cleaner carefully to avoid the surrounding plastic parts. Do not use appliance wax, polish, bleach or products containing chlorine on Stainless Steel finishes.
- Plastic Color Panels: Use a clean, soft, lightly dampened cloth, then dry thoroughly.
- Door Seal: It's important to keep the area clean where the door seals against the microwave. Use only mild, non-abrasive detergents applied with a clean sponge or soft cloth. Rinse well
- Bottom: Clean off the grease and dust on the bottom often. Use a solution of warm water and detergent.

Replacing the LED lamp.

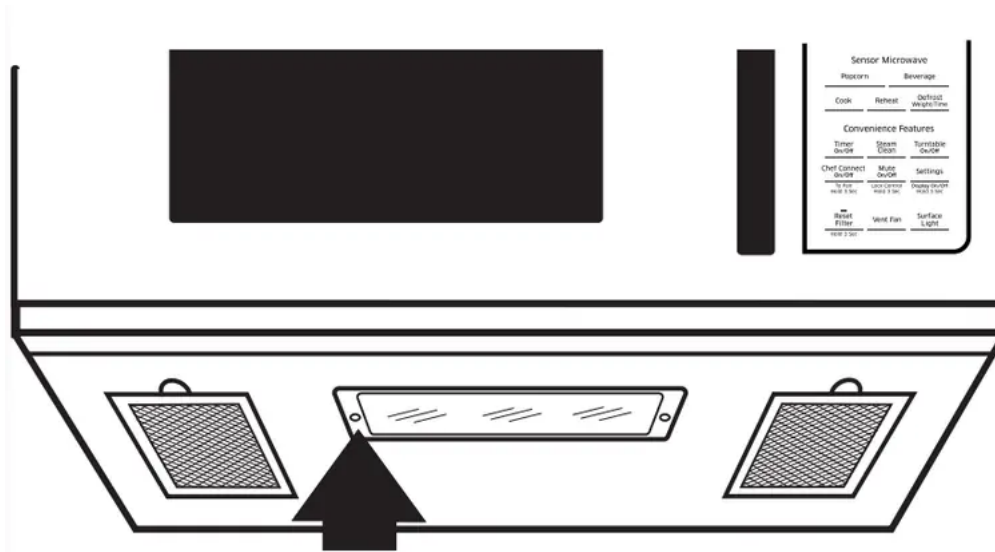

Remove screw.

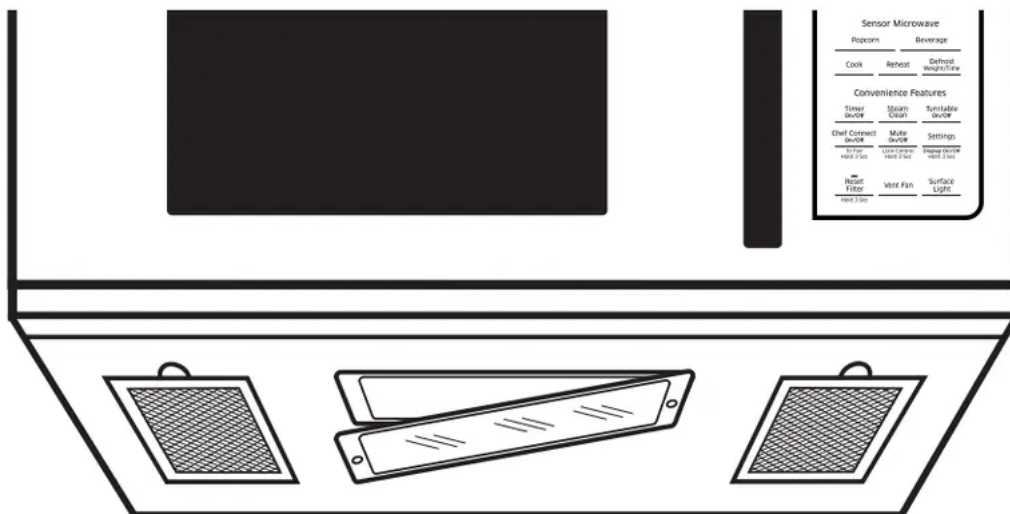

Cooktop Light/Nite Light

Replace with LED lamp. Order WB02X26814 from your GE supplier.

1. To replace the cooktop light/nite light, first disconnect the power at the main fuse or circuit breaker panel, or pull the plug.
2. Remove the screw from the side of the light compartment cover and lower the cover until it stops.
3. Be sure the bulb is cool before removing. Remove a screw and connector from LED lamp.

4. Connect LED lamp and secure using the screw. Raise the light cover and replace the screw. Connect electrical power to the oven.

About the exhaust feature.

Vent Fan

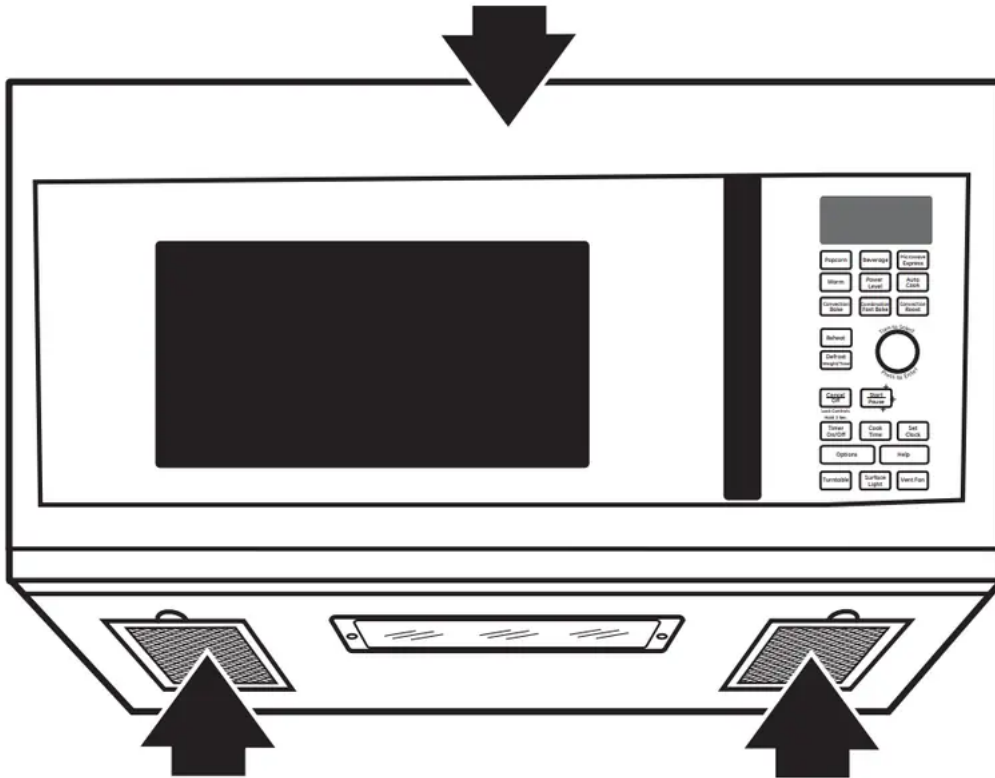

Reusable vent filters (on all models).

- The vent fan has two metal reusable vent filters.
- Models that recirculate air back into the room also use a charcoal filter.

Reusable Vent Filters

- The metal filters trap grease released by foods on the cooktop. They also prevent flames from foods on the cooktop from damaging the inside of the oven.
- For this reason, the filters must always be in place when the hood is used. The vent filters should be cleaned once a month, or as needed.

Removing and Cleaning the Filters

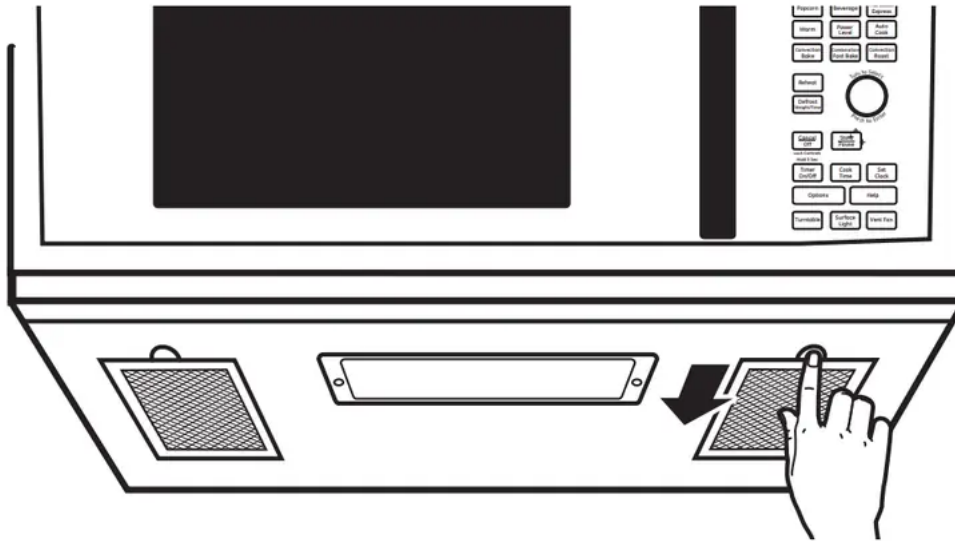

- To remove, slide them to the rear using the tabs. Pull down and out.
- To clean the vent filters, soak them and then swish around in hot water and detergent. Don't use ammonia or ammonia products because they will darken the metal. Light brushing can be used to remove embedded dirt.
- Rinse, shake and let dry before replacing.
- To replace, slide the filters into the frame slots on the back of each opening. Press up and to the front to lock into place.

Charcoal Filter

- The charcoal filter cannot be cleaned. It must be replaced. Order Part No. JX81H from your GE supplier.
- If the model is not vented to the outside, the air will be recirculated through a disposable charcoal filter that helps remove smoke and odors.
- The charcoal filter should be replaced when it is noticeably dirty or discolored (usually after 6 to 12 months, depending on usage). See "Optional Kits," page 8, for more information.

To Remove the Charcoal Filter

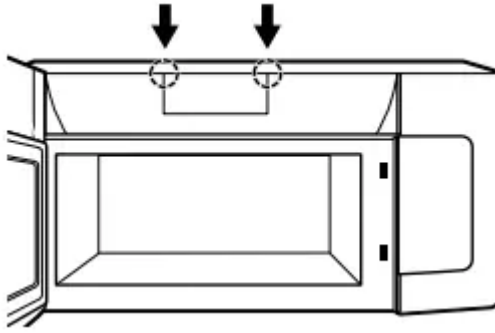

- To remove the charcoal filter, first disconnect power at the main fuse or circuit breaker, or pull the plug. Push down 2 buttons on the filter door.
- Lift the filter at the bottom until it comes free of the tabs. Slide the filter down and out.

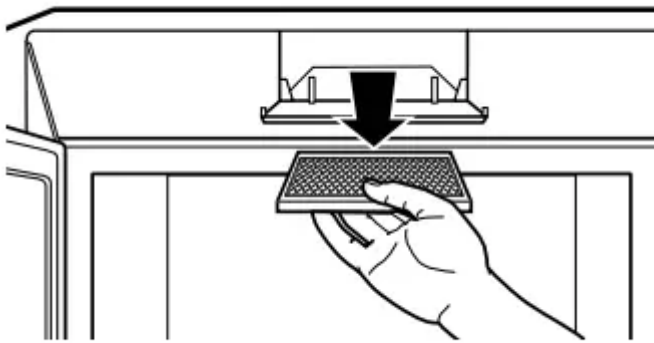

To Install the Charcoal Filter

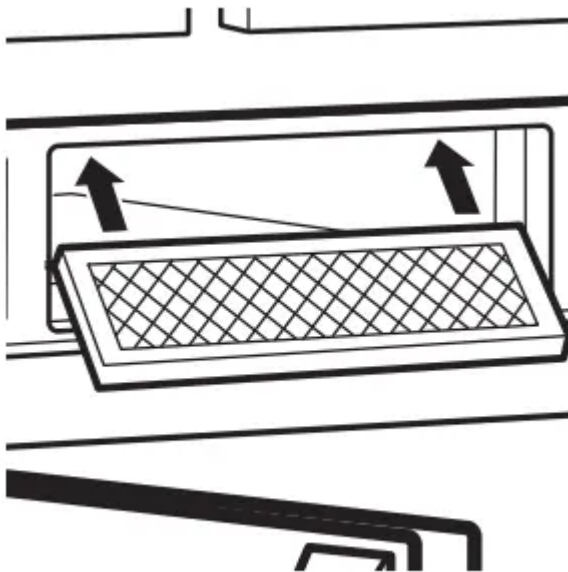

- To install a new charcoal filter, remove plastic and other outer wrapping from the new filter.

- Insert the top of the filter up. Push the bottom of the filter in until it rests in place behind the tabs. Close filter door.

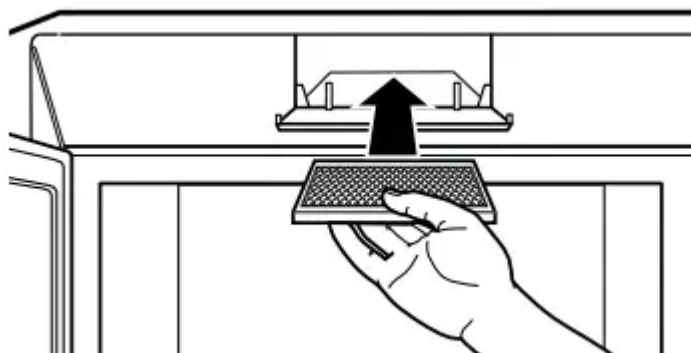

Troubleshooting



Problem	Possible Causes	What To Do
Oven will not start	A fuse in your home may be blown or the circuit breaker tripped.	<ul style="list-style-type: none"> • Replace fuse or reset circuit breaker.
	Power surge.	<ul style="list-style-type: none"> • Unplug the microwave oven, then plug it back in.
	Plug not fully inserted into wall outlet.	<ul style="list-style-type: none"> • Make sure the 3-prong plug on the microwave is fully inserted into wall outlet.
	Door not securely closed.	<ul style="list-style-type: none"> • Open the door and close securely.
Control panel lighted, yet oven will not start	Door not securely closed.	<ul style="list-style-type: none"> • Open the door and close securely.
	Start/Pause button not pressed after entering cooking selection.	<ul style="list-style-type: none"> • Press Start/Pause.
	Another selection entered already in oven and Cancel/Off button not pressed to cancel it.	<ul style="list-style-type: none"> • Press Cancel/Off.
	Cooking time not entered after pressing Cook Time.	<ul style="list-style-type: none"> • Make sure you have entered cooking time after pressing Cook Time.
	Cancel/Off was pressed accidentally.	<ul style="list-style-type: none"> • Reset cooking program and press Pause.
	Food weight not entered after selecting Auto Defrost or Fast Defrost.	<ul style="list-style-type: none"> • Make sure you have entered food weight after selecting Auto Defrost or Fast Defrost.
	Food type not entered after pressing Auto Cook.	<ul style="list-style-type: none"> • Make sure you have entered a food type after pressing Auto Cook.
CONTROL LOCKED appears on display	The control has been locked.	<ul style="list-style-type: none"> • Press and hold Mute On/Off for 3 seconds to unlock the control.



<i>OVEN TOO HOT FOR SENSOR COOKING--- USING ALTERNATE METHOD appears on display</i>	One of the sensor cooking buttons was pressed when the temperature inside the oven was greater than 200°F.	<ul style="list-style-type: none"> • These features will not operate when the oven is hot. The oven will automatically change to cook by time (follow the instructions in the display) or once the oven is cool enough, the sensor features will function normally.
<i>Floor of the oven is warm even when the oven has not been used</i>	The cooktop light is located below the oven floor. When light is on, the heat it produces may make the oven floor get warm.	<ul style="list-style-type: none"> • This is normal.
<i>You hear an unusual low-tone beep</i>	You have tried to change the power level when it is not allowed.	<ul style="list-style-type: none"> • Many of the oven's features are pre-set and cannot be changed.
<i>Oven emits a smoky odor and gray smoke after using the Bake feature</i>	Oils on the stainless steel cavity are burning off after using the Bake feature the first few times	<ul style="list-style-type: none"> • This is normal.
<i>Food browns on top much faster than on the bottom</i>	Rack has been placed in the "high" position	<ul style="list-style-type: none"> • Always use the rack in its "low" position.
<i>Oven temperature fluctuates during cooking</i>	The cooking element cycles on and off to maintain the oven temperature at the desired setting	<ul style="list-style-type: none"> • This is normal.
<i>Vent fan comes on automatically</i>	The vent fan automatically turns on to protect the microwave if it senses too much heat rising from the cooktop below.	<ul style="list-style-type: none"> • This is normal.
	During Bake, Roast or Fast Bake (after preheating), the vent fan will automatically come on to cool the oven components.	<ul style="list-style-type: none"> • This is normal.
<i>SENSOR ERROR appears on the display</i>	When using a Sensor feature, the door was opened before steam could be detected.	<ul style="list-style-type: none"> • Do not open door until steam is seen. Time is shown counting down on the display.



Steam was not detected in a maximum amount of time.

• Use Cook Time to heat for more t

Things That Are Normal With Your Microwave Oven

- Moisture on the oven door and walls while cooking. Wipe the moisture off with a paper towel or soft cloth.
- Moisture between the oven door panels when cooking certain foods. Moisture should dissipate shortly after cooking is finished.
- Steam or vapor escaping from around the door.
- Light reflection around door or outer case.
- Dimming oven light and change in the blower sound at power levels other than high.
- Dull thumping sound while oven is operating.
- The vent fan operating while the microwave is operating. The vent fan will not go off nor can it be turned off until the microwave is off.
- Warm, convection bake, convection roast and combination fast bake have a maximum cooking time of 179 minutes (2 hours and 59 minutes). When the maximum cooking time is reached, the oven will automatically indicate that cooking is complete and turn off the cooking element.
- When using convection bake, convection roast or combination fast bake with a preheat, the oven door must be opened and the cooking time set after preheat or the oven will turn off the cooking element after 1 hour.
- TV -rdio interference might be noticed while using the microwave. Similar to the interference caused by other small appliances, it does not indicate a problem with the microwave. Plug the microwave into a different electrical circuit, move the radio or TV as far away from the microwave as possible or check the position and signal of the TV/radio antenna.

Warning

This content is compiled from multiple sources and is provided for reference purposes only. It may not be complete or fully applicable to all situations. If you are unable to resolve your issue, please contact the product manufacturer or an authorized service provider for official support.