

Operating Instructions

About the features of your microwave oven.

Throughout this manual, features and appearance may vary from your model.

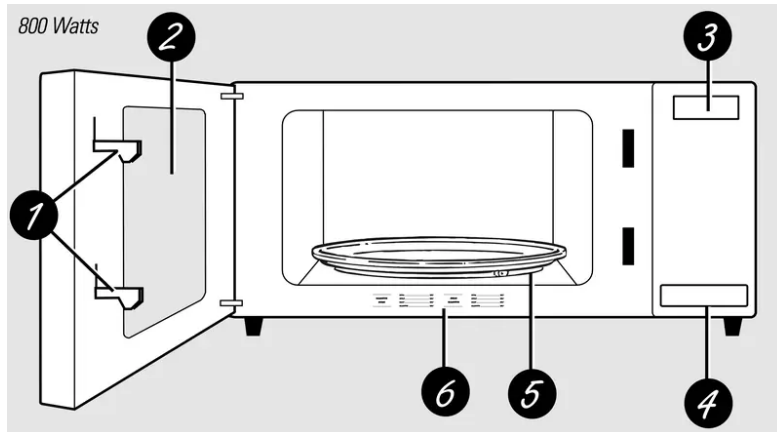

Features of the Oven

1. **Door Latches.**
2. **Window with Metal Shield.** Screen allows cooking to be viewed while keeping microwaves confined in the oven.
3. **Touch Control Panel Display.**
4. **Door Latch Release.** Press latch release to open door.
5. **Removable Turntable.** Turntable and support **must** be in place when using the oven. The turntable may be removed for cleaning.
6. **Convenience Guide.**

NOTE: Rating plate, oven vent(s) and oven light are located on the inside walls of the microwave oven.

Optional Accessories

Available at extra cost from your GE supplier.

04-A019 Hanging Kit allows this oven to be mounted under a cabinet.

JX827 27" Built-In Kit allows this oven to be built into a cabinet or wall.

You can microwave by time, with the sensor features or with the auto feature.

Cooking Controls

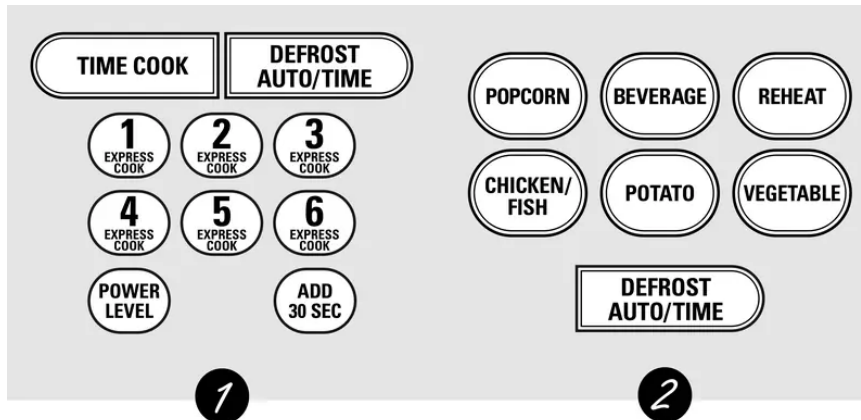

Check the Convenience Guide before you begin.

1

Time Features

| <i>Press</i> | <i>Enter</i> |
|---|---------------------------|
| TIME COOK Press once or twice | Amount of cooking time |
| DEFROST AUTO/TIME Press twice | Amount of defrosting time |
| EXPRESS COOK | Starts immediately! |
| ADD 30 SEC | Starts immediately! |
| POWER LEVEL | Power level 1–10 |

2

Sensor Features and Auto Feature

| <i>Press</i> | <i>Enter</i> | <i>Option</i> |
|---|---------------------|--|
| POPCORN | Starts immediately! | more/less time |
| BEVERAGE | Starts immediately! | |
| REHEAT | Starts immediately! | more/less time |
| CHICKEN/FISH Press once (chicken pieces) Press twice (fish fillets) | Starts immediately! | more/less time |
| POTATO | Starts immediately! | more/less time |
| VEGETABLE Press once (fresh vegetables) Press twice (frozen vegetables) Press three times (canned vegetables) | Starts immediately! | more/less time more/less time more/less time (on some models) |
| DEFROST AUTO/TIME Press once | Food weight | |

About changing the power level.

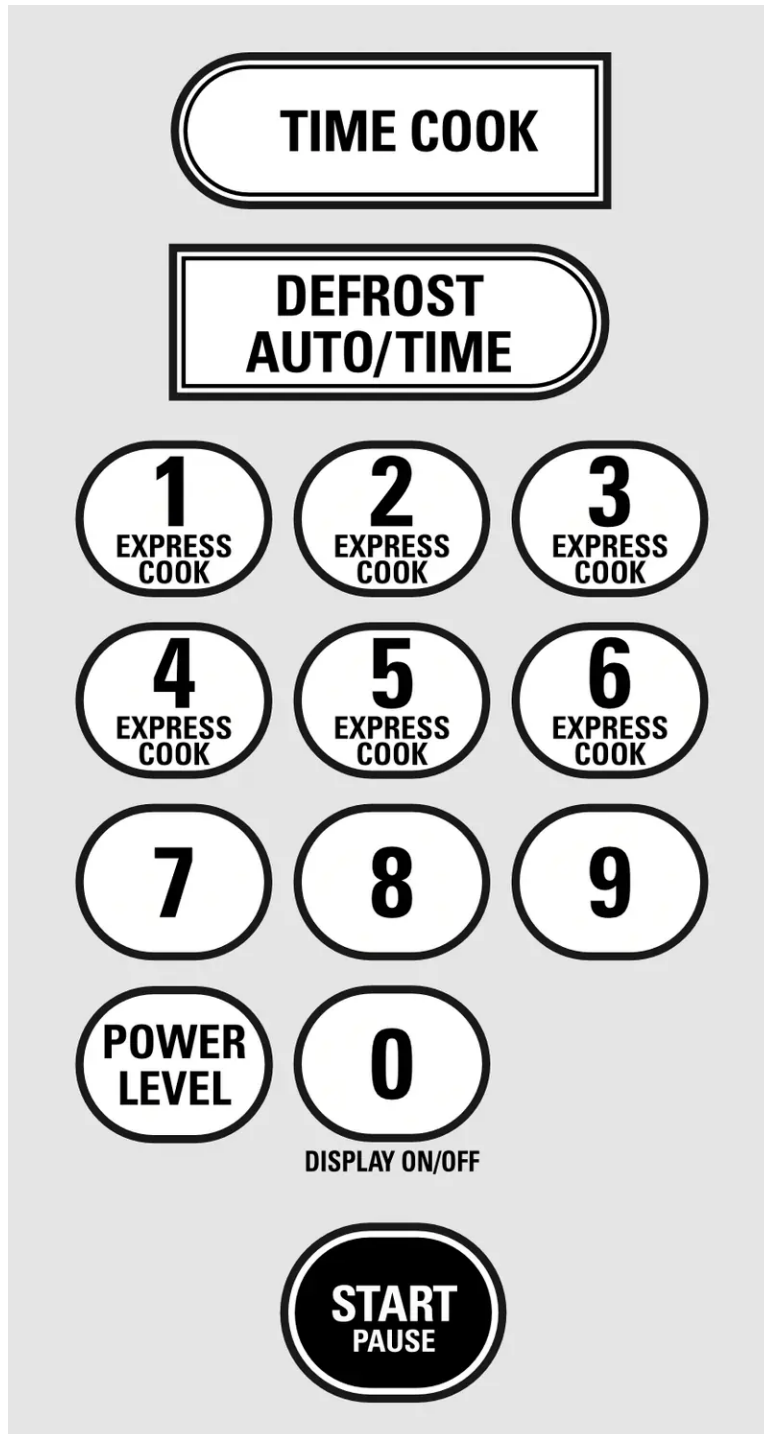

The power level may be entered or changed immediately after entering the feature time for **TIME COOK**, **TIME DEFROST** or **EXPRESS COOK**. The power level may also be changed during time countdown.

1. Press **TIME COOK** or select **Time Defrost**.
2. Enter cooking or defrosting time.
3. Press **POWER LEVEL**.
4. Select desired power level 1–10.

5. Press **START**.

Variable power levels add flexibility to microwave cooking. The power levels on the microwave oven can be compared to the surface units on a range.

Each power level gives you microwave energy a certain percent of the time. **Power level 7** is microwave energy 70% of the time. **Power level 3** is energy 30% of the time. Most cooking will be done on **High (power level 10)** which gives you 100% power. **Power level 10** will cook faster but food may need more frequent stirring, rotating or turning over. A lower setting will cook more evenly and need less stirring or rotating of the food. Some foods may have better flavor, texture or appearance if one of the lower settings is used. Use a lower power level when cooking foods that have a tendency to boil over, such as scalloped potatoes.

Rest periods (when the microwave energy cycles off) give time for the food to “equalize” or transfer heat to the inside of the food. An example of this is shown with **power level 3**—the defrost cycle. If microwave energy did not cycle off, the outside of the food would cook before the inside was defrosted.

Here are some examples of uses for various power levels:

High 10: Fish, bacon, vegetables, boiling liquids. **Med-High 7:** Gentle cooking of meat and poultry; baking casseroles and reheating.

Medium 5: Slow cooking and tenderizing for stews and less tender cuts of meat.

Low 2 or 3: Defrosting; simmering; delicate sauces.

Warm 1: Keeping food warm; softening butter.

About the time features.

Time Cook

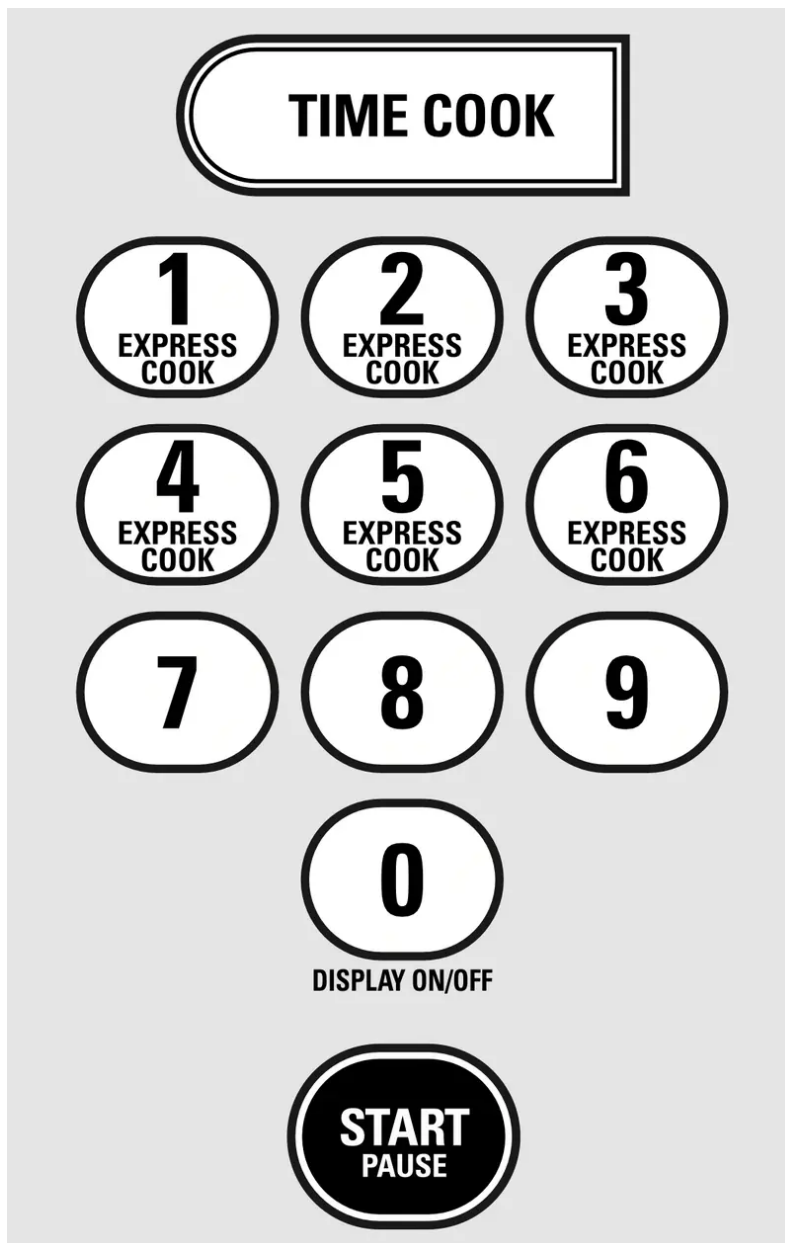

Time Cook I

Allows you to microwave for any time up to 99 minutes and 99 seconds.

Power level 10 (High) is automatically set, but you may change it for more flexibility.

1. Press **TIME COOK**.
2. Enter cooking time.
3. Change power level if you don't want full power. (Press **POWER LEVEL**. Select a desired power level 1–10.)

Press **START**.

You may open the door during **Time Cook** to check the food. Close the door and press **START** to resume cooking.

Time Cook II

Lets you change power levels automatically during cooking. Here's how to do it:

1. Press **TIME COOK**.
2. Enter the first cook time.
3. Change the power level if you don't want full power. (Press **POWER LEVEL**. Select a desired power level 1–10.)
4. Press **TIME COOK** again. Enter the second cook time.
5. Change the power level if you don't want full power. (Press **POWER LEVEL**. Select a desired power level 1–10.)
6. Press **START**.

At the end of **Time Cook I**, **Time Cook II** counts down.

Cooking Guide for Time Cook

NOTE: Use **power level High (10)** unless otherwise noted.



| Vegetable | Amount | Time | Comments |
|------------------------------------|---------------------------------|-------------------------------|--|
| Asparagus (fresh spears) | 1 lb. | 7 to 10 min., Med-High (7) | In 1½-qt. oblong glass baking dish, place 1/4 cup water. |
| (frozen spears) | 10-oz. package | 5 to 8 min. | In 1-qt. casserole. |
| Beans (fresh green) | 1 lb. cut in half | 12 to 17 min. | In 1½-qt. casserole, place 1/2 cup water. |
| (frozen green) | 10-oz. package | 5 to 9 min. | In 1-qt. casserole, place 2 tablespoons water. |
| (frozen lima) | 10-oz. package | 5 to 9 min. | In 1-qt. casserole, place 1/4 cup water. |
| Beets (fresh, whole) | 1 bunch | 18 to 25 min. | In 2-qt. casserole, place 1/2 cup water. |
| Broccoli (fresh cut) | 1 bunch (1¼ to 1½ lbs.) | 7 to 10 min. | In 2-qt. casserole, place 1/2 cup water. |
| (fresh spears) | 1 bunch (1¼ to 1½ lbs.) | 9 to 13 min. | In 2-qt. oblong glass baking dish, place 1/4 cup water. |
| (frozen, chopped) | 10-oz. package | 5 to 8 min. | In 1-qt. casserole. |
| (frozen spears) | 10-oz. package | 5 to 8 min. | In 1-qt. casserole, place 3 tablespoons water. |
| Cabbage (fresh) | 1 medium head (about 2 lbs.) | 8 to 11 min. | In 1½- or 2-qt. casserole, place 1/4 cup water. |
| (wedges) | | 7 to 10 min. | In 2- or 3-qt. casserole, place 1/4 cup water. |
| Carrots (fresh, sliced) | 1 lb. | 6 to 9 min. | In 1½-qt. casserole, place 1/4 cup water. |
| (frozen) | 10-oz. package | 5 to 8 min. | In 1-qt. casserole, place 2 tablespoons water. |
| Cauliflower (flowerets) | 1 medium head | 9 to 14 min. | In 2-qt. casserole, place 1/2 cup water. |
| (fresh, whole) | 1 medium head | 9 to 17 min. | In 2-qt. casserole, place 1/2 cup water. |
| (frozen) | 10-oz. package | 5 to 8 min. | In 1-qt. casserole, place 2 tablespoons water. |

| | | | |
|---|-------------------------------------|---------------------------------------|--|
| Corn (frozen kernel) | 10-oz. package | 4 to 8 min. | In 1-qt. casserole, place 2 tablespoons water. |
| Corn on the cob (fresh) | 1 to 5 ears | 3 to 5 min. per ear | In 2-qt. oblong glass baking dish, place corn. If corn is in husk, use no water; if corn has been husked, add 1/4 cup water. Rearrange after half of time. |
| (frozen) | 1 ear 2 to 6 ears | 5 to 7 min. 2 to 4 min. per ear | Place in 2-qt. oblong glass baking dish. Cover with vented plastic wrap. Rearrange after half of time. |
| Mixed vegetables (frozen) | 10-oz. package | 4 to 8 min. | In 1-qt. casserole, place 3 tablespoons water. |
| Peas (fresh, shelled) | 2 lbs. unshelled | 9 to 12 min. | In 1-qt. casserole, place 1/4 cup water. |
| (frozen) | 10-oz. package | 4 to 8 min. | In 1-qt. casserole, place 2 tablespoons water. |
| Potatoes (fresh, cubed, white) | 4 potatoes (6 to 8 oz. each) | 11 to 14 min. | Peel and cut into 1-inch cubes. Place in 2-qt. casserole with 1/2 cup water. Stir after half of time. |
| (fresh, whole, sweet or white) | 1 (6 to 8 oz.) | 2 to 5 min. | Pierce with cooking fork. Place in center of the oven. Let stand 5 minutes. |
| Spinach (fresh) | 10 to 16 oz. | 5 to 8 min. | In 2-qt. casserole, place washed spinach. |
| (frozen, chopped and leaf) | 10-oz. package | 5 to 8 min. | In 1-qt. casserole, place 3 tablespoons water. |
| Squash (fresh, summer and yellow) | 1 lb. sliced | 4 to 7 min. | In 1½-qt. casserole, place 1/4 cup water. |
| (winter, acorn or butternut) | 1 or 2 squash (about 1 lb. each) | 7 to 11 min. | Cut in half and remove fibrous membranes. In 2-qt. oblong glass baking dish, place squash cut-side-down. Turn cut-side-up after 4 minutes. |

Time Defrost

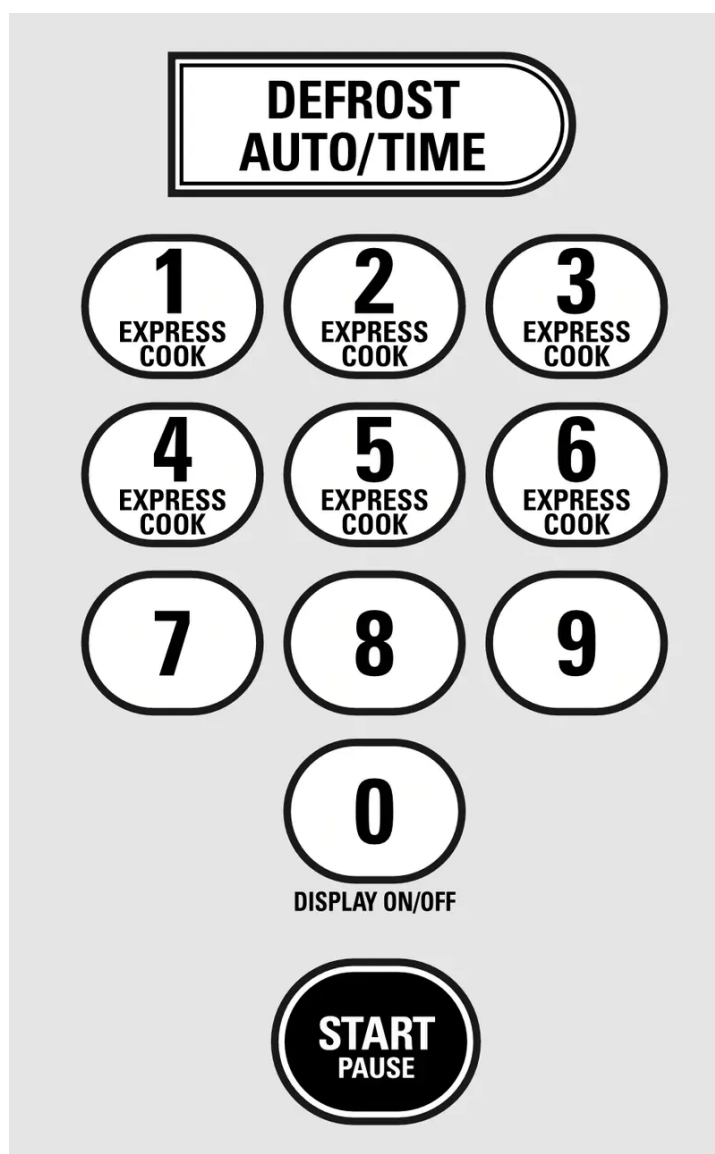

Allows you to defrost for a selected length of time. See the Defrosting Guide for suggested times. (**Auto Defrost** explained in the About the auto feature section.)

1. Press **DEFROST AUTO/TIME** twice.
2. Enter defrosting time.
3. Press **START**.
4. Turn food over when the oven signals.
5. Press **START**.

Power level is automatically set at 3, but can be changed. You can defrost small items quickly by raising the power level after entering the time. **Power level 7** cuts the total defrosting time in about half; **power level 10** cuts the total time to approximately 1/3. However, food will need more frequent attention than usual.

At one half of selected defrosting time, the oven signals **TURN**. At this time, turn food over and break apart or rearrange pieces for more even defrosting. Shield any warm areas with small pieces of foil.

A dull thumping noise may be heard during defrosting. This is normal when oven is not operating at **High** power.

Defrosting Tips

- Foods frozen in paper or plastic can be defrosted in the package. Closed packages should be slit, pierced or vented **AFTER** food has partially defrosted. Plastic storage containers should be partially uncovered.
- Family-size, prepackaged frozen dinners can be defrosted and microwaved. If the food is in a foil container, transfer it to a microwave-safe dish.
- Foods that spoil easily should not be allowed to sit out for more than one hour after defrosting. Room temperature promotes the growth of harmful bacteria.
- For more even defrosting of larger foods, such as roasts, use **Auto Defrost**. Be sure large meats are completely defrosted before cooking.
- When defrosted, food should be cool but softened in all areas. If still slightly icy, return to the microwave very briefly or let it stand a few minutes.

Defrosting Guide

| Food | Time | Comments |
|---|---|---|
| Breads, Cakes <i>Bread, buns or rolls (1 piece)</i> <i>Sweet rolls (approx. 12 oz.)</i> | 1/2 min. 2 to 4 min. | |
| Fish and Seafood <i>Fillets, frozen (1 lb.)</i> <i>Shellfish, small pieces (1 lb.)</i> | 8 to 12 min. 5 to 8 min. | Place block in casserole. Turn over and break up after half the time. |
| Fruit <i>Plastic pouch – 1 or 2 (10-oz. package)</i> | 3 to 7 min. | |
| Meat <i>Bacon (1 lb.)</i> <i>Franks (1 lb.)</i> <i>Ground meat (1 lb.)</i> <i>Roast: beef, lamb, veal, pork</i> <i>Steaks, chops and cutlets</i> | 3 to 6 min. 3 to 6 min. 5 to 8 min. 10 to 16 min. per lb. 5 to 10 min. per lb. | Place unopened package in oven. Let stand 5 minutes after defrosting. Place unopened package in oven. Microwave just until franks can be separated. Let stand 5 minutes, if necessary, to complete defrosting. Turn meat over after half the time. Use power level 1 . Place unwrapped meat in cooking dish. Turn over after half the time and shield warm areas with foil. When finished, separate pieces and let stand to complete defrosting. |
| Poultry <i>Chicken, broiler-fryer cut up (2½ to 3 lbs.)</i> <i>Chicken, whole (2½ to 3 lbs.)</i> <i>Cornish hen</i> <i>Turkey breast (4 to 6 lbs.)</i> | 16 to 22 min. 22 to 28 min. 9 to 16 min. per lb. 5 to 10 min. per lb. | Place wrapped chicken in dish. Unwrap and turn over after half the time. When finished, separate pieces and microwave 2–4 minutes more, if necessary. Let stand to finish defrosting. Place wrapped chicken in dish. After half the time, unwrap and turn chicken over. Shield warm areas with foil. Finish defrosting. If necessary, run cold water in the cavity until giblets can be removed. Place unwrapped hen in the oven breast-side-up. Turn over after half the time. Run cool water in the cavity until giblets can be removed. Place unwrapped breast in dish breast-side-down. After half the time, turn over and shield warm areas with foil. Finish defrosting. Let stand 1–2 hours in refrigerator to complete defrosting. |

Express Cook



This is a quick way to set cooking time for 1–6 minutes.

Press one of the **Express Cook** pads (from 1 to 6) for 1 to 6 minutes of cooking at **power level 10**. For example, press the **2** pad for 2 minutes of cooking time.

The power level can be changed as time is counting down. Press **POWER LEVEL** and enter 1–10.

Add 30 Seconds



You can use this feature two ways:

- It will add 30 seconds to the time counting down each time the pad is pressed.
- It can be used as a quick way to set 30 seconds of cooking time.

About the auto feature.

Auto Defrost

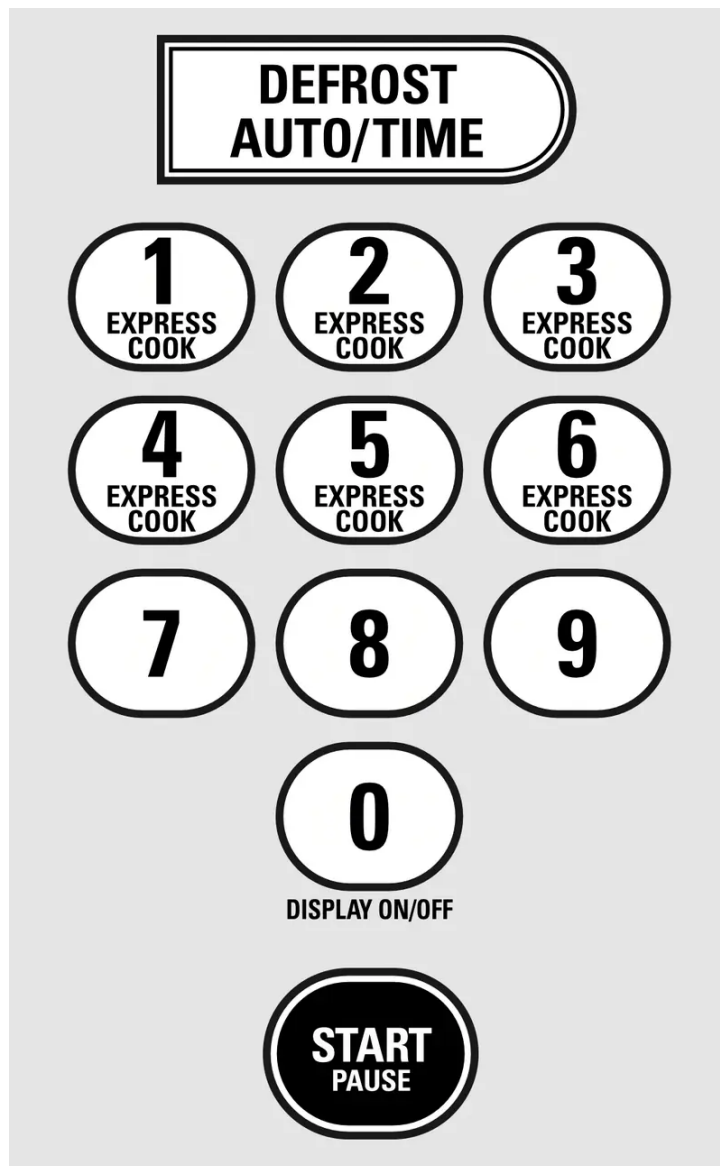

The **Defrost Auto/Time** feature gives you two ways to defrost frozen foods. Press **DEFROST AUTO/TIME** once for **Auto Defrost** or twice for **Time Defrost**.

Use **Auto Defrost** for meat, poultry and fish. Use **Time Defrost** for most other frozen foods.

Auto Defrost automatically sets the defrosting times and power levels to give even defrosting results for meats, poultry and fish weighing up to 6 pounds.

1. Press **DEFROST AUTO/TIME** once.
2. Using the Conversion Guide below, enter food weight. For example, press pads **1** and **2** for 1.2 pounds (1 pound, 3 ounces).
3. Press **START**. (**Time Defrost** is explained in the About the time features section.)

There is a handy guide located on the inside front of the oven.

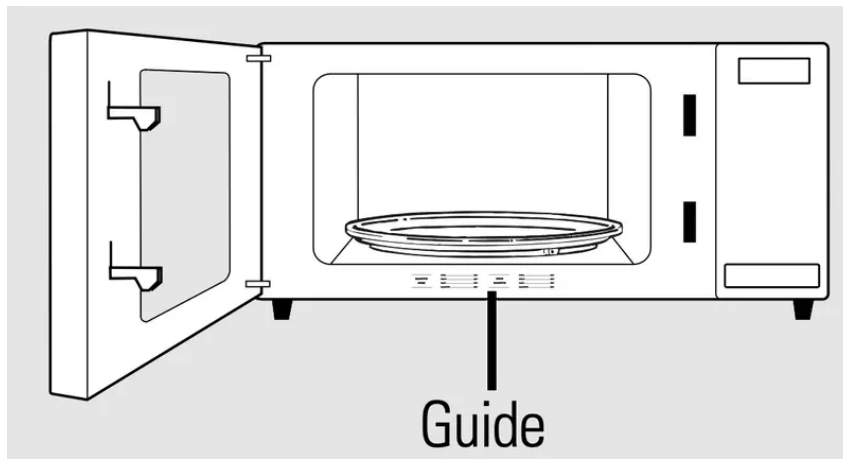

- Remove meat from package and place on microwavesafe dish.
- Twice during defrost, the oven signals **TURN**. At each **TURN** signal, turn the food over. Remove defrosted meat or shield warm areas with small pieces of foil.
- After defrosting, most meats need to stand 5 minutes to complete defrosting. Large roasts should stand for about 30 minutes.

Conversion Guide

If the weight of food is stated in pounds and ounces, the ounces must be converted to tenths (.1) of a pound.

| <i>Weight of Food in Ounces</i> | <i>Enter Food Weight (tenths of a pound)</i> |
|--|---|
| <i>1–2</i> | <i>.1</i> |
| <i>3</i> | <i>.2</i> |
| <i>4–5</i> | <i>.3</i> |
| <i>6–7</i> | <i>.4</i> |
| <i>8</i> | <i>.5</i> |
| <i>9–10</i> | <i>.6</i> |
| <i>11</i> | <i>.7</i> |
| <i>12–13</i> | <i>.8</i> |
| <i>14–15</i> | <i>.9</i> |

About the sensor features.

Humidity Sensor

The **Sensor Features** detect the increasing humidity released during cooking. The oven automatically adjusts the cooking time to various types and amounts of food.

Do not use the Sensor Features twice in succession on the same food portion—it may result in severely overcooked or burnt food. If food is undercooked after the countdown, use **Time Cook** for additional cooking time.

Covered

The proper containers and covers are essential for best sensor cooking.

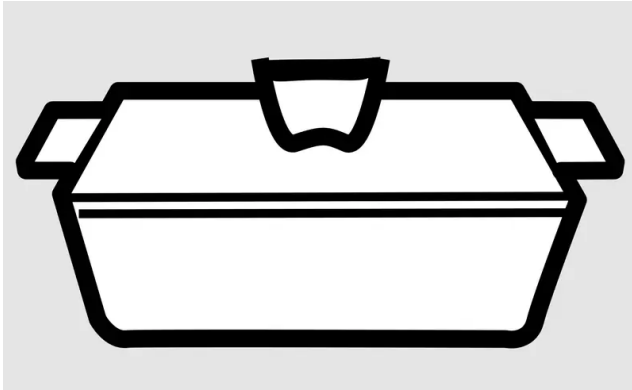

Vented

Always use microwave-safe containers and cover them with lids or vented plastic wrap. Never use tight-sealing plastic containers—they can prevent steam from escaping and cause food to overcook.

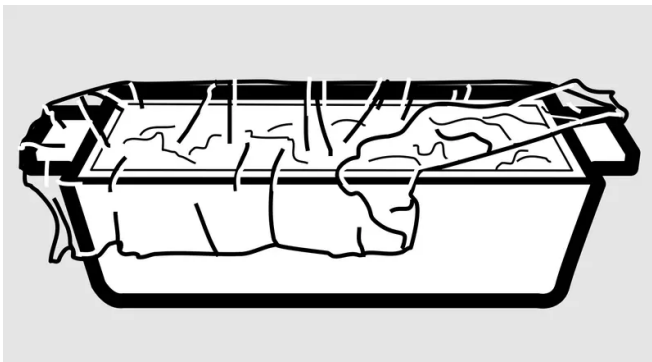

Dry off dishes so they don't mislead the sensor.

Be sure the outside of the cooking containers and the inside of the microwave oven are dry before placing food in the oven. Beads of moisture turning into steam can mislead the sensor.

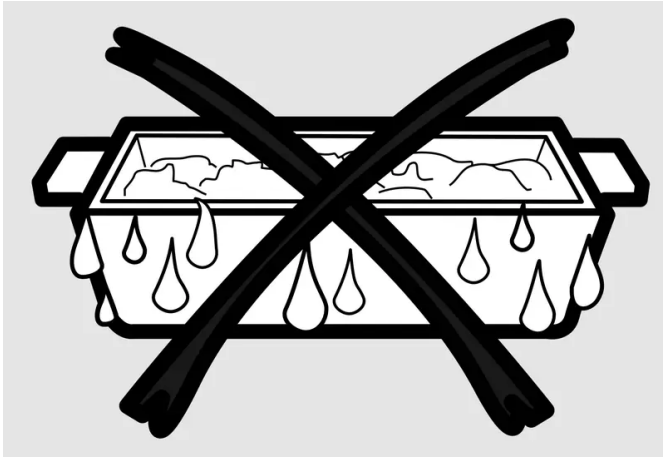

Popcorn

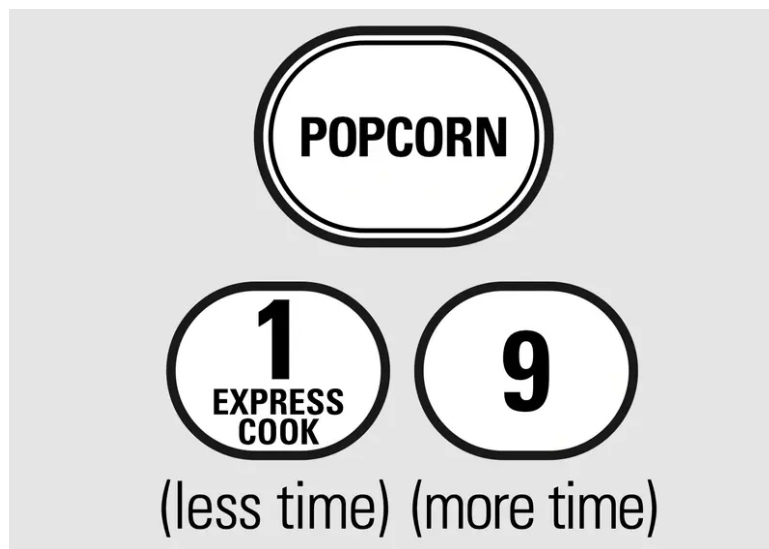

Use only with prepackaged microwave popcorn weighing 3.0 to 3.5 ounces.

NOTE: Do not use this feature twice in succession on the same food portion it may result in severely overcooked or burnt food.

To use the **Popcorn** feature:

1. Follow package instructions, using **Time Cook** if the package is less than 3.0 ounces or larger than 3.5 ounces. Place the package of popcorn in the center of the microwave.
2. Press **POPCORN**. The oven starts immediately.

If you open the door while **POPCORN** is displayed, **SENSOR ERROR** will appear. Close the door, press **CLEAR/OFF** and begin again.

During the **POPCORN** cycle, the turntable will rotate, stop, then rotate again. This feature provides optimum results.

If food is undercooked after the countdown use **Time Cook** for additional cooking time.

How to Adjust the Popcorn Program to Provide a Shorter or Longer Cook Time

If you find that the brand of popcorn you use underpops or overcooks consistently, you can add or subtract 20–30 seconds to the automatic popping time.

To add time: After pressing **POPCORN**, press 9 immediately after the oven starts for an extra 20 seconds. Press 9 again to add another 10 seconds (total 30 seconds additional time).

To subtract time: After pressing **POPCORN**, press 1 immediately after the oven starts for 20 seconds less cooking time. Press 1 again to reduce cooking time another 10 seconds (total 30 seconds less time).

Beverage



NOTE: Do not use this feature twice in succession on the same food portion it may result in severely overcooked or burnt food.

Press **BEVERAGE** to heat a cup of coffee or other beverage.

Drinks heated with the Beverage feature may be very hot. Remove the container with care.

If food is undercooked after the countdown use **Time Cook** for additional cooking time.

Reheat

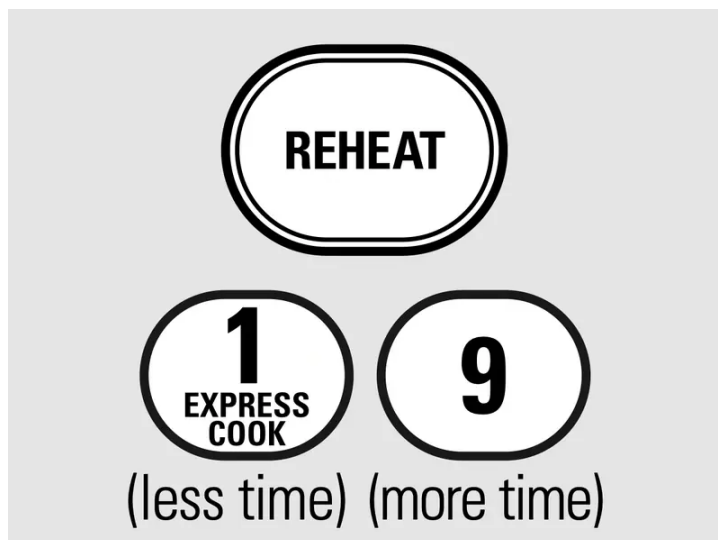

NOTE: Do not use this feature twice in succession on the same food portion it may result in severely overcooked or burnt food.

The Reheat feature reheats single servings of previously cooked foods or a plate of leftovers.

1. Place covered food in the oven. Press **REHEAT**. The oven starts immediately.
2. The oven signals when steam is sensed and the time remaining begins counting down.

Do not open the oven door until time is counting down. If the door is opened, close it and press **START** immediately.

After removing food from the oven, stir, if possible, to even out the temperature. Reheated foods may have wide variations in temperature. Some areas may be extremely hot.

If food is not hot enough after the countdown, use **Time Cook** for additional reheating time.

Some Foods Not Recommended for Use With Reheat

It is best to use **Time Cook** for these foods:

- Bread products.
- Foods that must be reheated uncovered.
- Foods that need to be stirred or rotated.
- Foods calling for a dry look or crisp surface after reheating.

How to Change the Automatic Settings

To reduce time by 10%: Press **1** after the feature pad.

To add 10% to cooking time: Press **9** after the feature pad.

Sensor Cooking

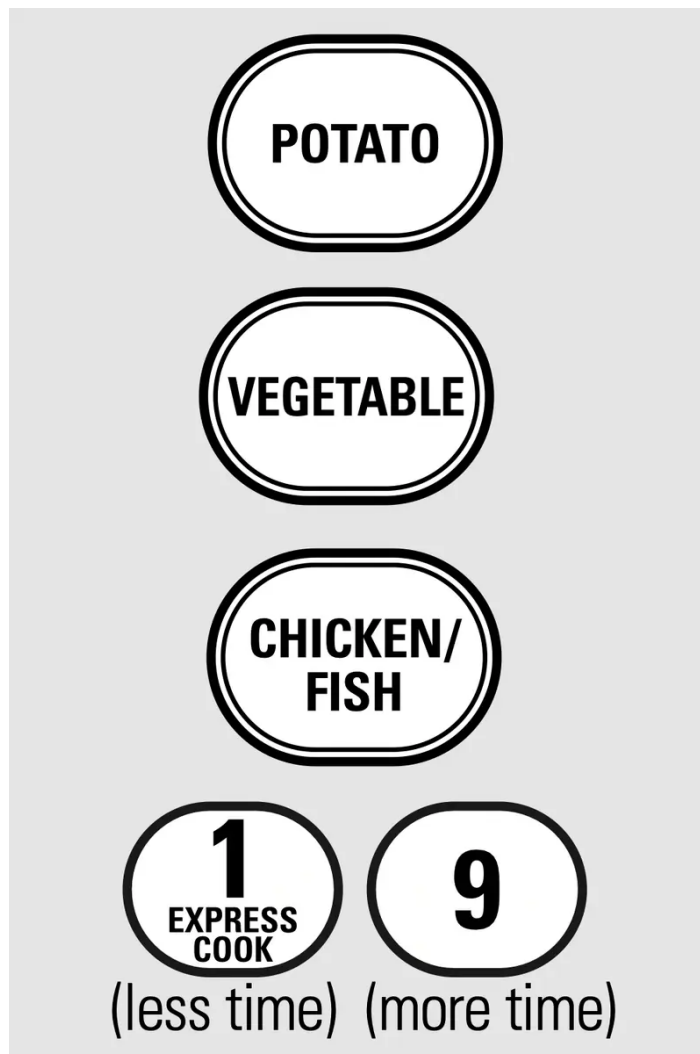

Sensor cooking gives you easy, automatic results with a variety of foods (see the Cooking Guide below).

NOTE: Do not use this feature twice in succession on the same food portion it may result in severely overcooked or burnt food.

Vegetables, Potatoes, Fish, Chicken Pieces

Place covered food in the oven. Press the food pad. For vegetables, press the VEGETABLE pad once for fresh vegetables, twice for frozen vegetables or three times for canned vegetables. For chicken or fish, press the CHICKEN/FISH pad once for chicken pieces or twice for fish. The oven starts immediately.

The oven signals when steam is sensed and the time remaining begins counting down. Turn or stir the food if necessary.

Do not open the oven door until time is counting down. If the door is opened, close it and press **START** immediately.

If food is undercooked after the countdown, use **Time Cook** for additional cooking time.

How to Change the Automatic Settings (automatic settings for canned vegetables cannot be adjusted on some models):

You can adjust the cooking time for all foods to suit your personal taste.

To reduce time by 10%: Press **1** within 30 seconds after pressing the food pad.

To add 10% to cooking time: Press **9** within 30 seconds after pressing the food pad.

Cooking Guide

| Food Type | Amount | Comments |
|--------------------------|---------------|--|
| Canned Vegetables | 4–16 oz | Cover with lid or vented plastic wrap. |
| Frozen Vegetables | 4–16 oz | Follow package instructions for adding water. Cover with lid or vented plastic wrap. |
| Fresh Vegetables | 4–16 oz | Add 1/4 cup water per serving. Cover with lid or vented plastic wrap. |
| Potatoes | 1/2–2 lbs | Pierce skin with fork. Place potatoes on the turntable. |
| Fish | 4–16 oz | Cover with vented plastic wrap. |
| Chicken Pieces | 1–8 pieces | Cover with vented plastic wrap. |

About the other features.

Help

The **HELP** pad displays feature information and helpful hints. Press **HELP**, then select a feature pad.



Cooking Complete Reminder

To remind you that you have food in the oven, the oven will display **FOOD IS READY** and beep once a minute until you either open the oven door or press **CLEAR/OFF**.

Clock

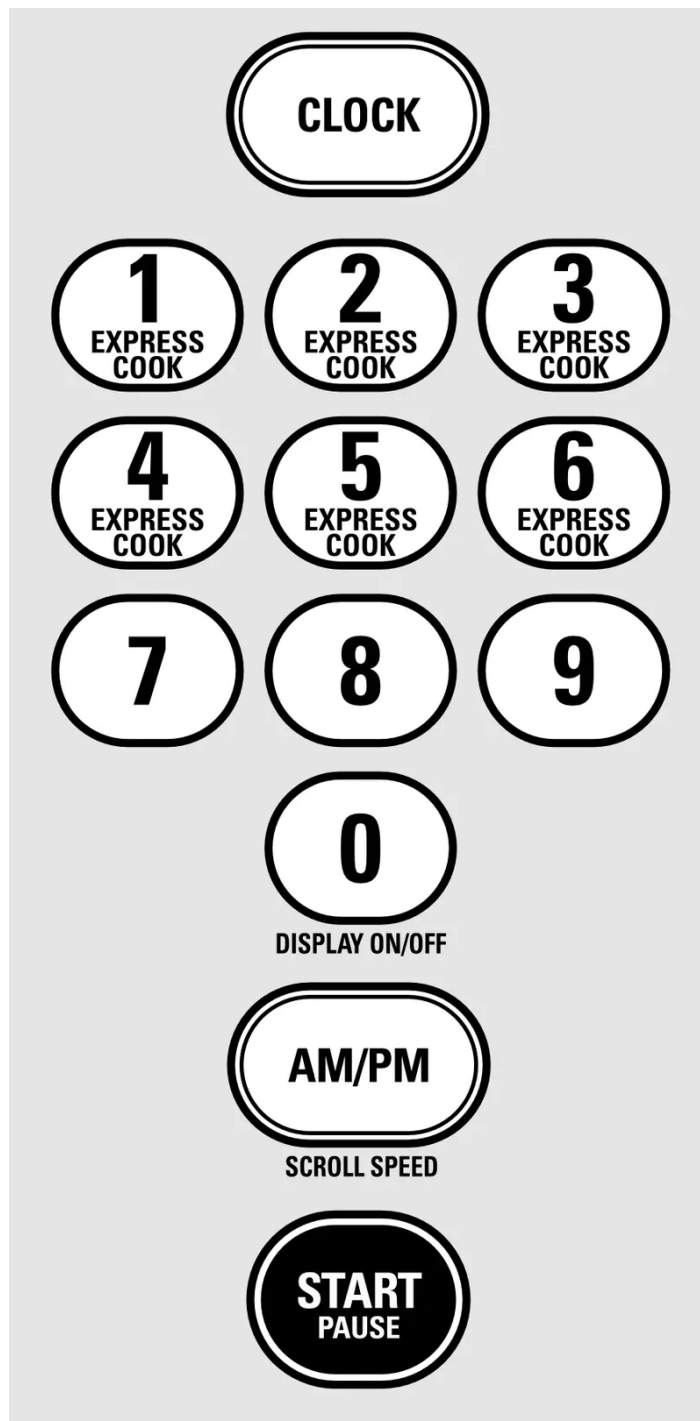

Press to enter the time of day or to check the time of day while microwaving.

1. Press **CLOCK**.
2. Enter time of day.
3. Select AM or PM.
4. Press **START** or **CLOCK**.

Scroll Speed

The scroll speed of the display can be changed. Press and hold the **AM/PM** pad about 3 seconds to bring up the display. Select 1–5 for slow to fast scroll speed.

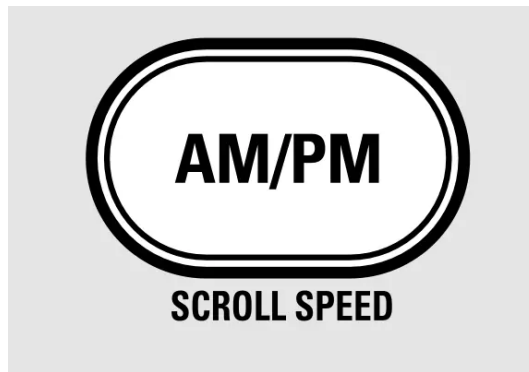

Start/Pause

In addition to starting many functions, **START/PAUSE** allows you to stop cooking without opening the door or clearing the display.



Reminder

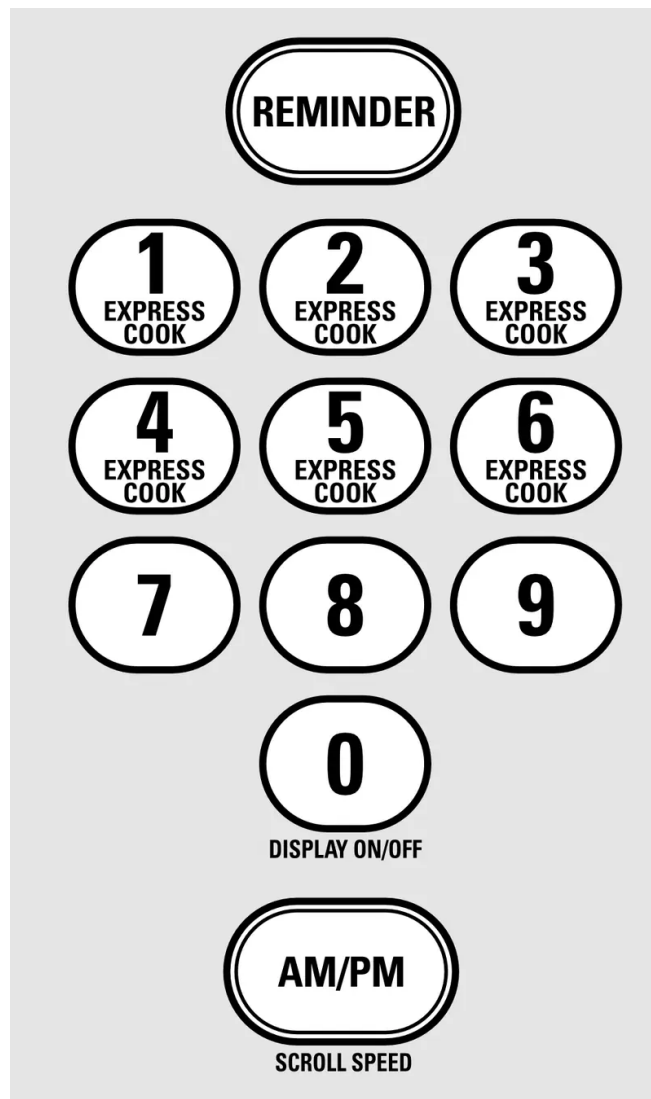

The **Reminder** feature can be used like an alarm clock and can be used at any time, even when the oven is operating. The **Reminder** time can be set up to 24 hours later.

1. Press **REMINDER**.
2. Enter the time you want the oven to remind you. (Be sure the microwave clock shows the correct time of day.)
3. Select AM or PM.
4. Press **REMINDER**. When **Reminder** signal occurs, press **REMINDER** to turn it off. The **Reminder** time may be displayed by pressing **REMINDER**.

NOTE: The **REM** indicator will remain lit to show that the **Reminder** is set. To clear the **Reminder** before it occurs, press **REMINDER**, then **0**. The **REM** indicator will no longer be lit.

Delay Start

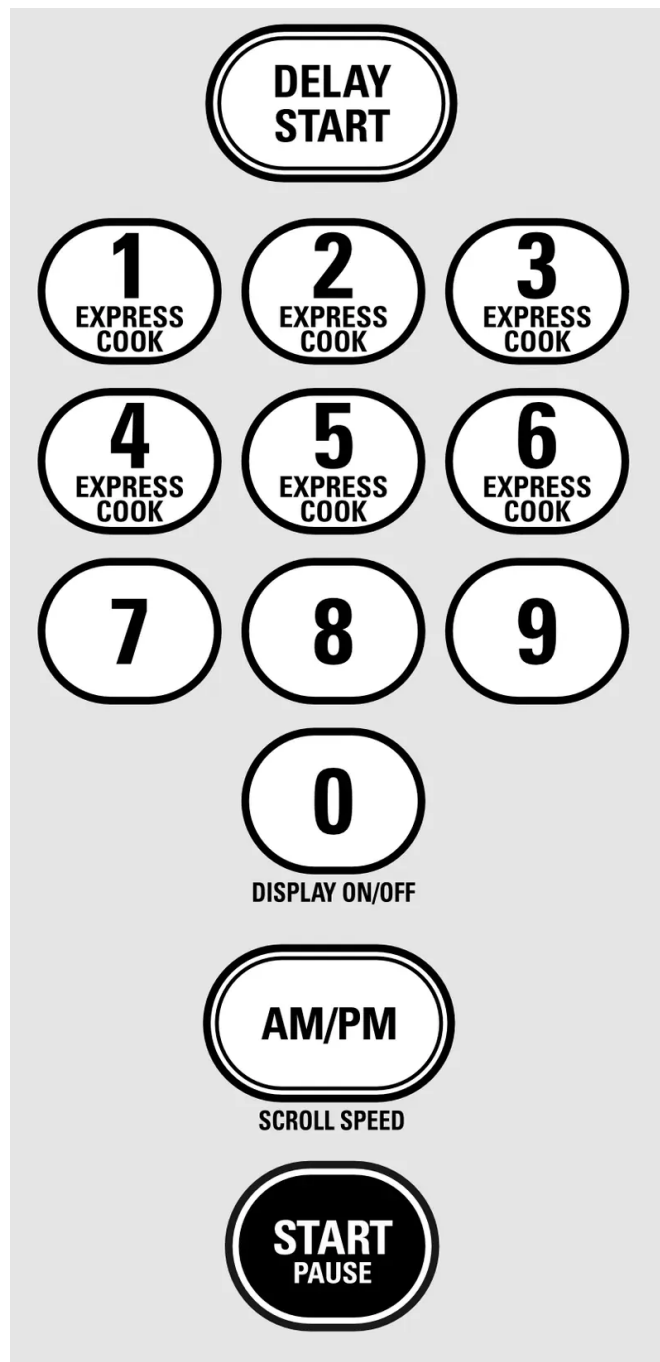

Delay Start allows you to set the microwave to delay cooking up to 24 hours.

1. Press **DELAY START**.
2. Enter the time you want the oven to start. (Be sure the microwave clock shows the correct time of day.)
3. Select AM or PM.
4. Select any combination of **Defrost Auto/Time** and **Time Cook**.
5. Press **START**.

The **Delay Start** time will be displayed plus **DS**. The oven will automatically start at the delayed time.

The time of day may be displayed by pressing **CLOCK**.

Child Lock-Out



You may lock the control panel to prevent the microwave from being accidentally started or used by children.

To lock or unlock the controls, press and hold **CLEAR/OFF** for about three seconds. When the control panel is locked, an L will be displayed to the extreme right.

Turntable



For best cooking results, leave the turntable on.

It can be turned off for large dishes. Press **TURNTABLE** to turn the turntable on or off.

Sometimes the turntable can become too hot to touch. Be careful touching the turntable during and after cooking.

Timer On/Off

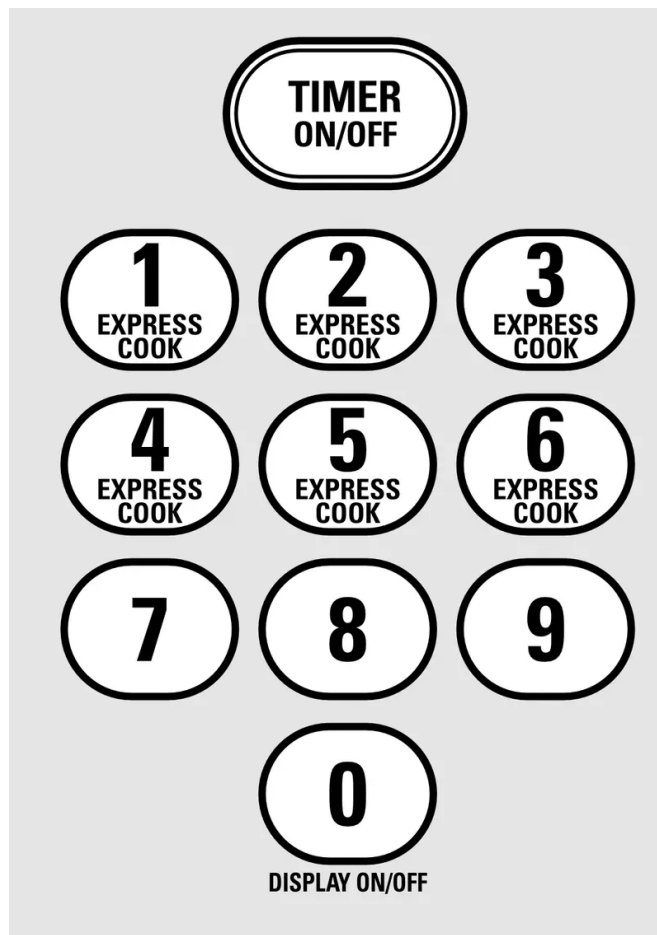

Timer On/Off operates as a minute timer and can be used at any time, even when the oven is operating.

1. Press **TIMER ON/OFF**.
2. Enter time you want to count down.
3. Press **TIMER ON/OFF** to start.

When time is up, the oven will signal. To turn off the timer signal, press **TIMER ON/OFF**.

NOTE: The timer indicator will be lit while the timer is operating.

Display On/Off

To turn the clock display on or off, press and hold **0** for about 3 seconds. The **Display On/Off** feature cannot be used while a cooking feature is in use.

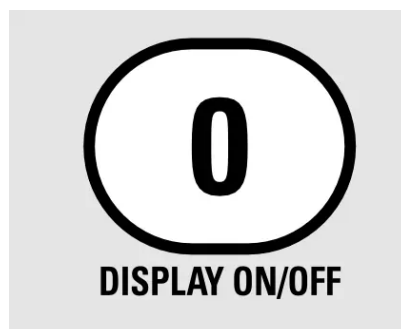

Microwave terms.

| Term | Definition |
|----------------------|---|
| Arcing | Arcing is the microwave term for sparks in the oven. Arcing is caused by: <ul style="list-style-type: none">• metal or foil touching the side of the oven.• foil that is not molded to food (upturned edges act like antennas).• metal such as twist-ties, poultry pins, gold-rimmed dishes.• recycled paper towels containing small metal pieces. |
| Covering | Covers hold in moisture, allow for more even heating and reduce cooking time. Venting plastic wrap or covering with wax paper allows excess steam to escape. |
| Shielding | In a regular oven, you shield chicken breasts or baked foods to prevent over-browning. When microwaving, you use small strips of foil to shield thin parts, such as the tips of wings and legs on poultry, which would cook before larger parts. |
| Standing Time | When you cook with regular ovens, foods such as roasts or cakes are allowed to stand to finish cooking or to set. Standing time is especially important in microwave cooking. Note that a microwaved cake is not placed on a cooling rack. |
| Venting | After covering a dish with plastic wrap, you vent the plastic wrap by turning back one corner so excess steam can escape. |

Care and cleaning of the microwave oven.

Helpful Hints

An occasional thorough wiping with a solution of baking soda and water keeps the inside fresh.

Unplug the cord before cleaning any part of this oven.



How to Clean the Inside

Walls, Floor, Inside Window, Metal and Plastic Parts on the Door

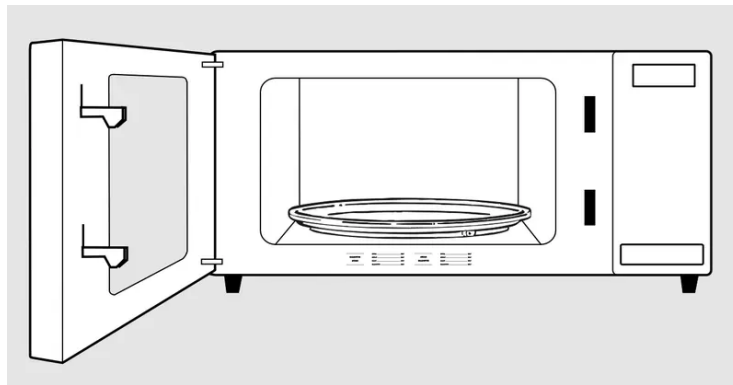

Some spatters can be removed with a paper towel; others may require a damp cloth. Remove greasy spatters with a sudsy cloth, then rinse with a damp cloth. Do not use abrasive cleaners or sharp utensils on oven walls.

To clean the surface of the door and the surface of the oven that come together upon closing, use only mild, nonabrasive soaps or detergents using a sponge or soft cloth. Rinse with a damp cloth and dry.

Never use a commercial oven cleaner on any part of your microwave.

Removable Turntable and Turntable Support

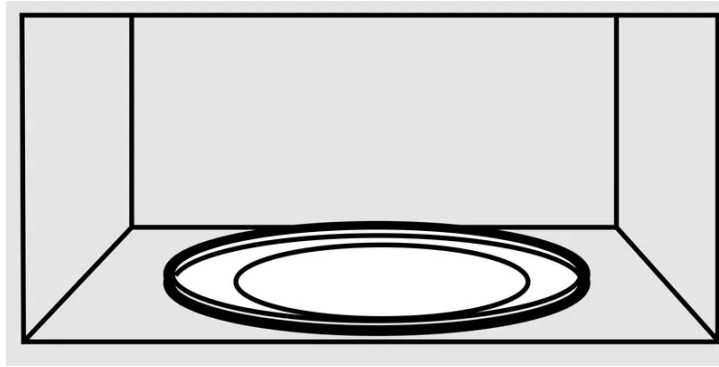

To prevent breakage, do not place the turntable into water just after cooking. Wash it carefully in warm, sudsy water or in the dishwasher. The turntable and support can be broken if dropped. Remember, do not operate the oven without the turntable and support in place.

How to Clean the Outside

Do not use cleaners containing ammonia or alcohol on the microwave oven. Ammonia or alcohol can damage the appearance of the microwave.

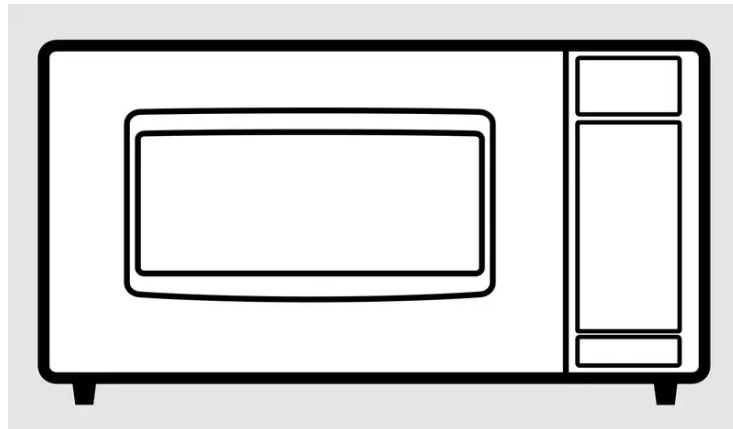

Case

Clean the outside of the microwave with a sudsy cloth. Rinse and then dry. Wipe the window clean with a damp cloth.

Control Panel and Door

Wipe with a damp cloth. Dry thoroughly. Do not use cleaning sprays, large amounts of soap and water, abrasives or sharp objects on the panel—they can damage it. Some paper towels can also scratch the control panel.

Door Surface

It's important to keep the area clean where the door seals against the microwave. Use only mild, non-abrasive detergents applied with a clean sponge or soft cloth. Rinse well.

Stainless Steel (on some models)

Do not use a steel-wood pad; it will scratch the surface.

To clean the stainless steel surface, use a hot, damp cloth with a mild detergent suitable for stainless steel surfaces. Use a clean, hot, damp cloth to remove soap. Dry with a dry, clean cloth. Always scrub lightly in the direction of the grain.



Troubleshooting



| Problem | Possible Causes | What To Do |
|---|---|--|
| Oven will not start | A fuse in your home may be blown or the circuit breaker tripped. | Replace fuse or reset circuit breaker. |
| | Power surge. | Unplug the microwave oven, then plug it back in. |
| | Plug not fully inserted into wall outlet. | Make sure the 3-prong plug on the oven is fully inserted into wall outlet. |
| | Door not securely closed. | Open the door and close securely. |
| Control panel lighted, yet oven will not start | Door not securely closed. | Open the door and close securely. |
| | START pad not pressed after entering cooking selection. | Press START . |
| | Another selection entered already in oven and CLEAR/OFF pad not pressed to cancel it. | Press CLEAR/OFF . |
| | Cooking time not entered after pressing TIME COOK . | Make sure you have entered cooking time after pressing TIME COOK . |
| | CLEAR/OFF was pressed accidentally. | Reset cooking program and press START . |
| | Food weight not entered after selecting Auto Defrost . | Make sure you have entered food weight after selecting Auto Defrost . |
| “SENSOR ERROR” appears on display | During Popcorn, Reheat, Beverage, Chicken/Fish, Potato, or Vegetable program, the door was opened before steam could be detected. | Close the door, press CLEAR/OFF and begin again. |
| | Steam was not detected in maximum amount of time. | Use Time Cook to heat for more time. |

| Problem | Possible Causes | What To Do |
|--|---|--|
| “LOCKED” appears in display | The control has been locked. (When the control panel is locked, an L will be displayed.) | Press and hold CLEAR/OFF for about three seconds to unlock the control. |
| Food amount too large for Sensor Reheat | Sensor Reheat is for single servings of recommended foods. | Use Time Cook for large amounts of food. |

Things That Are Normal With Your Microwave Oven

- Steam or vapor escaping from around the door.
- Light reflection around door or outer case.
- Dimming oven light and change in the blower sound at power levels other than high.
- Dull thumping sound while oven is operating.
- Turntable starts and stops automatically during **POPCORN**.
- TV/radio interference might be noticed while using the microwave. Similar to the interference caused by other small appliances, it does not indicate a problem with the microwave. Plug the microwave into a different electrical circuit, move the radio or TV as far away from the microwave as possible, or check the position and signal of the TV/radio antenna.

Warning

This content is compiled from multiple sources and is provided for reference purposes only. It may not be complete or fully applicable to all situations. If you are unable to resolve your issue, please contact the product manufacturer or an authorized service provider for official support.