

User Manual Tefal AH900015 Actify family

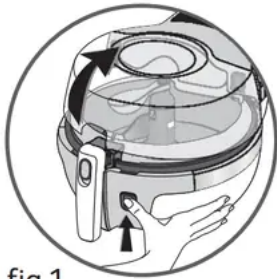

fig.1

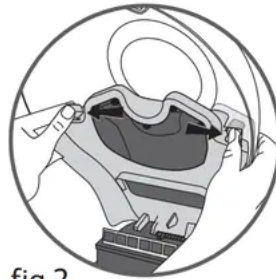

fig.2

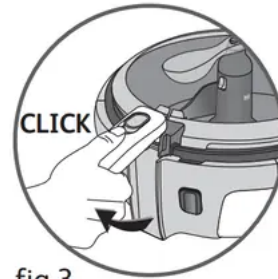

fig.3

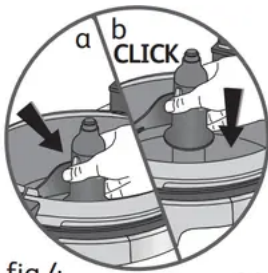

fig.4



fig.5



fig.6

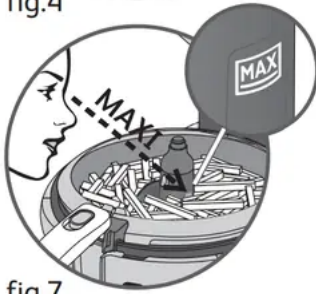

fig.7

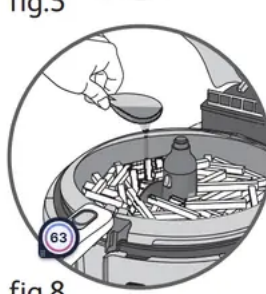

fig.8



fig.9



fig.10

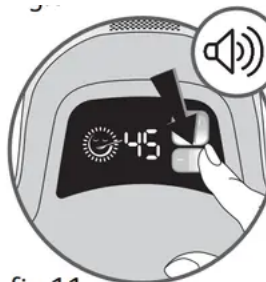

fig.11



fig.12



fig.13

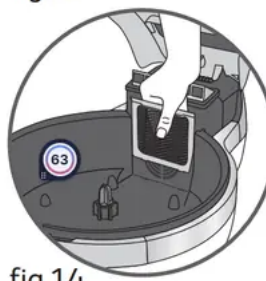

fig.14

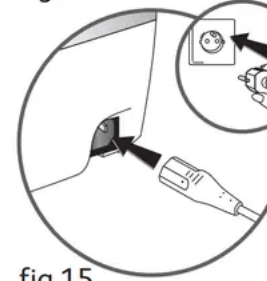

fig.15



Innovating for your health

Nutrition is of course about having a varied and balanced diet. but that is not all. because nutrition is about much more than just the ingredients. The way you cook them plays an essential role in their nutritional and organoleptic transformation (taste. texture and so on).

And because cooking appliances are not all equal in their capacities. has developed a range that is devoted to NUTRITION FOR GREATER PLEASURE: ingenious utensils which preserve the food's nutritional integrity and allow the true taste of the ingredients out.

Providing you with unique solutions

Tefal makes considerable investment into research in order to create appliances with unique nutritional performances which are then confirmed by scientific studies.

Keeping you informed

Tefal has always been a partner for your food preparation, making everything quicker, practical and simply more fun for you. Day after day, the Tasty Nutrition range from **Tefal** will help you to share the pleasure you have in cooking and in a balanced diet, by:

- preserving the qualities of the natural ingredients you use, which are so important to your diet,
- limiting the use of fat,
- promoting a return to traditional flavours and tastes,
- reducing the time it takes you to prepare a meal.

Within this product range, **ActiFry[®] family** enables you to prepare 1.5 kg of potatoes into homemade chips with just a spoonful of your favourite oil!

Welcome to the world of **ActiFry[®] family** !

Make delicious traditional chips. your own way

The chips are crisp on the outside and soft in the centre. thanks to our patented technologies: the mixing paddle which distributes the oil evenly. and the pulsed hot air. Choose your ingredients. oil.

herbs and spices. and let **ActiFry[®] family** do all the rest.

Only 3% fat*: 1 spoonful (20 ml) of oil is enough!

Just one spoonful of the oil you choose enables you to make 1.5 kg of real chips. Thanks to the measuring spoon that comes with the appliance. use just the amount of oil you need. :

*1.5 kg of fresh chips with a cross-section of 13x13 mm. cooked until weight loss of -55% with 20 ml of oil.

Chips and much more besides!

ActiFry[®] family enables you to cook a whole variety of recipes.

- In addition to chips and potatoes. you can vary your daily meals with crunchy vegetables. tasty tender sliced meat. crispy fried prawns. fruit and more besides.



Comes with a free booklet of family recipes prepared by great chefs and nutritionists.

You'll find original ideas for "Chips the way you like them". healthy nutritional dishes and even tasty desserts to make with your family.

- **ActiFry[®] family** also cooks frozen food very well. a nice alternative to fresh produce. Frozen food is very practical and retains the nutritional qualities and the flavour of food.

To make your meals a real success, **ActiFry[®] family** gives you hints and tips on potatoes and oils.

Potatoes: balance and pleasure each and every day!

Potatoes are a great food for everybody at every age! They are an excellent source of energy and vitamins.

Depending on the variety. the climate and the way they are grown. there are a huge number of different kinds of potato: shape. size. flavour. Each of them has its own characteristics in terms of seasonality. yield. size. colour. conservation and culinary uses. The cooking results therefore vary depending on the origin and the season.

What variety should you be using with **ActiFry[®] family**

Generally speaking. we recommend that you use potatoes that are marketed as especially good for chips. For newly harvested potatoes which have a high water content. we recommend that you

fry them for a few extra minutes. **ActiFry[®] family** also makes it possible to cook frozen chips. Because they are already precooked in oil, there is no need to add any oil.

Where should I keep my potatoes?

The best places to keep potatoes are a good cellar or a cool cupboard (between 6 and 8°C), out of the light.

How should I prepare my potatoes for use with **ActiFry[®] family ?**

For the best results, you need to make sure that the chips do not stick to one another. To do this, we recommend that you wash the whole potatoes thoroughly before cutting them and then once again when they have been cut, until the water runs clear. This will enable you to remove as much starch as possible. Dry the chips carefully using a dry and highly absorbent tea towel. The chips need to be perfectly dry before they are put into

Remember the cooking time of the chips will vary according to the weight of chips and the batch of potatoes used.

How should I cut my potatoes?

The size of the chip has an influence on how crunchy or soft they are. The thinner your chips your chips, the crunchier they will be and conversely, if they are very thick, they will be softer in the middle. Depending on what you're looking for, you can vary how you cut your chips and adapt the cooking time accordingly:

Thin American style: 8 x 8 mm / Standard: 10 x 10 mm / Thick: 13 x 13 mm. Length: Up to approximately 9 cm

In **ActiFry[®] family** the maximum recommended chip thickness is 13 x 13 mm and a length of up to 9 cm.

Vary the oils that are good for you

You can vary the type of oil depending on your choice or for different needs. Choose a different oil every time you cook! All of them contain, in various proportions, those nutrients that are so essential for balanced diet. To provide your body with everything it needs, vary your oils! With

ActiFry[®] family you can use a whole variety of oils:

- Standard oils: olive, rapeseed*, grapeseed, corn, groundnut (peanut), sunflower, soya*
- Flavoured oils: oils infused with herbs, garlic, pepper, lemon...

- Speciality oils: hazelnut*. sesame*. almond*. avocado*. argan* (*cooking time according to manufacturer).

Note: Some of these oils are not available in the UK.

Because it uses so little oil during cooking. enables you to preserve all of the good fats that you need for your vitality.



With **ActiFry® family** and the oil you choose. your chips will be of a higher nutritional standard. Depending on your taste and what you're looking for. you can add an extra spoonful of oil for that extra flavour! But this will increase the fat content.

With **ActiFry® family** make tasty. healthier chips for your family as a real treat!

Important recommendations

Safety instructions

- Read these instructions carefully and keep them in a safe place.
- This appliance is not intended to be operated using an external timer or separate remote control system.
- For your safety. this appliance conforms with applicable standards and regulations (Directives on Low Voltage. Electromagnetic Compatibility. Materials in contact with food. Environment. etc.).
- Check that the voltage of your mains network corresponds to the voltage given on the rating plate on the appliance (alternative current).
- Given that there are so many different standards. if the appliance is to be used in a country other than that in which it was bought. have it checked by Approved Service Centre.
- This product has been designed for domestic use only. Any commercial use. inappropriate use or failure to comply with the instructions. the manufacturer accepts no responsibility and the guarantee will not apply.
- This appliance is intended to be used only in the household. It is not intended to be used in the following applications. and the guarantee will not apply for:
 - staff kitchen areas in shops. offices and other working environments;
 - farm houses inns.

- clients in hotels, motels and other residential type environments.
- bed and breakfast type environments.

Connecting to the power supply

- Do not use the appliance if it or the power cord is damaged or if it has fallen and has visible damage or appears to be working abnormally. If this occurs, the appliance must be sent to an Approved Service Centre.
- Do not use an extension lead. If you nevertheless decide to do so, under your own responsibility, use an extension lead that is in good condition and compliant with the power of the appliance.
- For models with detachable power cords, only use the original power cord.
- If the power cord is damaged, it must be replaced by the manufacturer, an approved After Sales Service or a similarly qualified person, in order to avoid any danger. Never take the appliance apart yourself.
- Do not let the power cord dangle.
- Do not unplug the appliance by pulling on the power cord.
- Always unplug your appliance: after use, to move it, or to clean it.

Operation

- Use the appliance on a flat, stable, heat-resistant work surface away from water splashes.
- This appliance is not designed to be used by people (including children) with a physical, sensory or mental impairment, or people without knowledge or experience, unless they are supervised or given prior instructions concerning the use of the appliance by someone responsible for their safety. Children must be supervised to ensure that they do not play with the appliance.
- The work surface can become hot when the appliance is operating, which could cause burns. Do not touch the hot surfaces of the appliance (the lid, visible metal parts, etc).
- Do not use the appliance close to inflammable materials (blinds, curtains, etc), nor close to an external heat source (gas hob, hotplate, etc).
- In the event of fire, unplug the appliance and smother the flames using a damp tea towel.
- Never move the appliance when it still contains hot food.
- Never immerse your appliance in water!

Cooking

- Never operate your appliance when empty.

- Never overload the cooking pan comply with the recommended quantities.
- Your appliance is fitted with a turn-over ring. This ring is designed particularly for cooking chips but we also recommend you use it when making recipes with the maximum quantity of food.

It must be removed for recipes using liquid.

Description

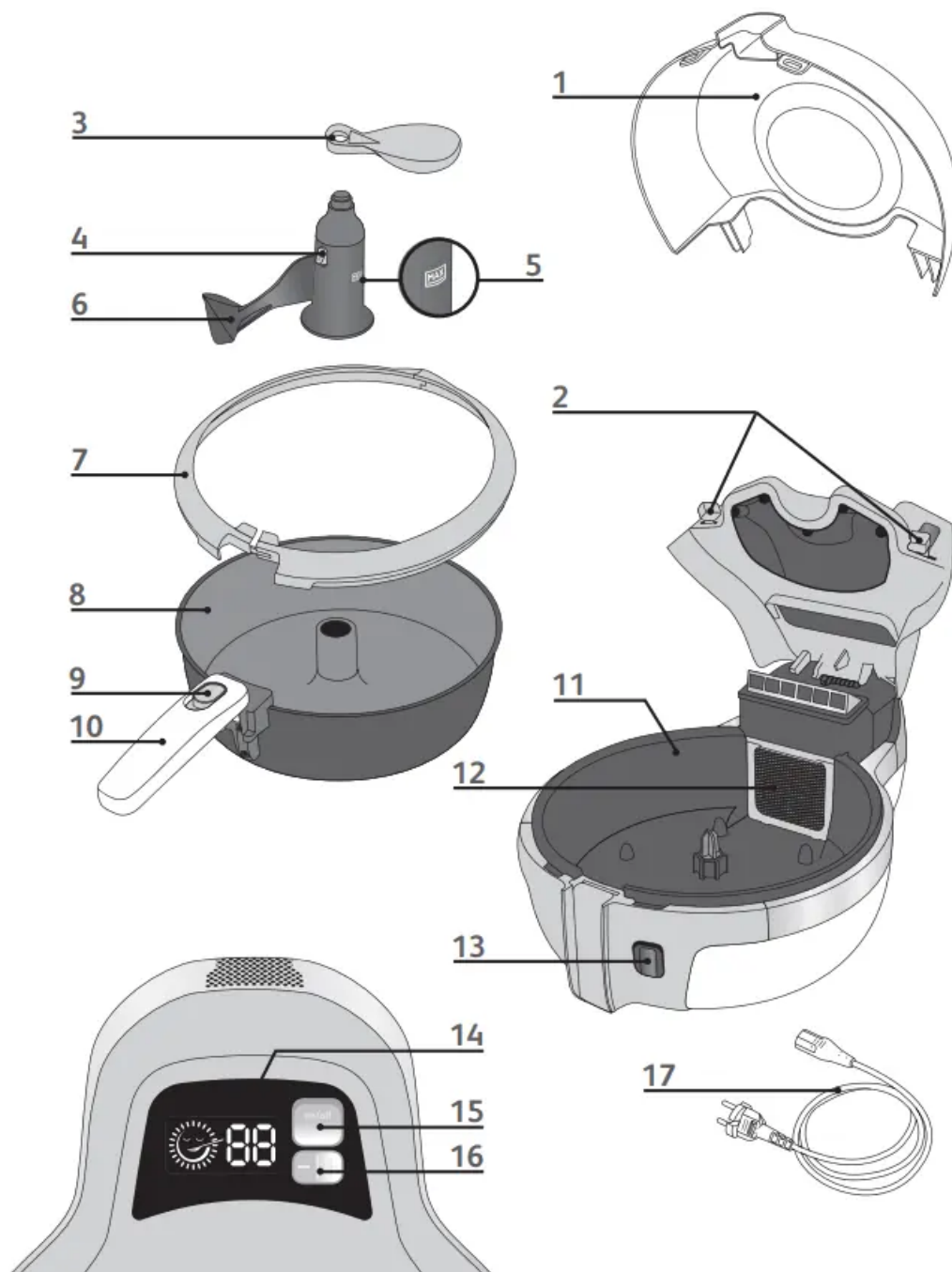

1. Transparent lid

2. Lid locks (x2)

3. Measuring spoon
4. Paddle release button
5. Maximum capacity for liquids and chips
6. Removable mixing paddle
7. Turn-over ring
8. Ceramic coated removable cooking pan
9. Handle release
10. Pan handle
11. Body
12. Removable filter
13. Lid opening button
14. LCD screen
15. On/off switch and Handle release button
16. Timer adjustment button +/- (in minutes)
17. Detachable power cord

Instructions for use

Before using for the first time

The ActiFry Resistant Technology pan has a ceramic coating which has a high resistance to scratching.

- To remove the lid - open the lid by pressing the lid opening button (13) - fig.1 and push the lid locks (2) outward to remove the lid - fig.2.

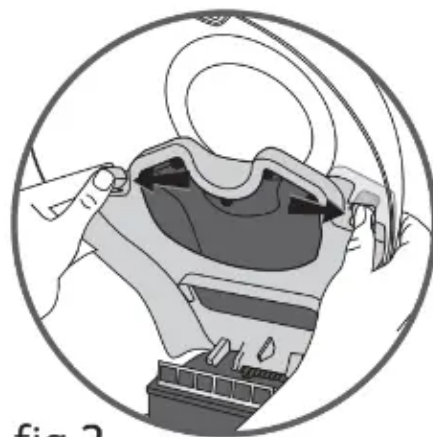

- Remove the measuring spoon.

- Lift the detachable pan handle until you hear a "CLICK" as it locks. in order to remove the pan - fig.3.

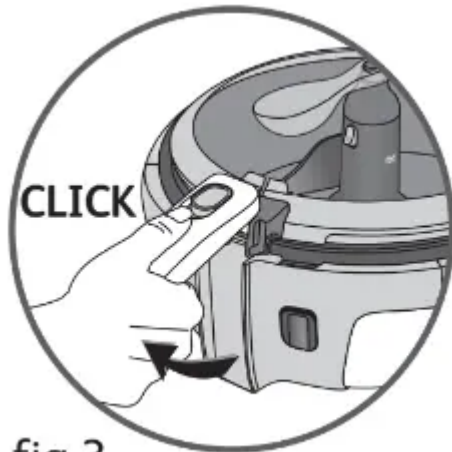

fig.3

- Remove the paddle by pushing the release button - fig.4a.

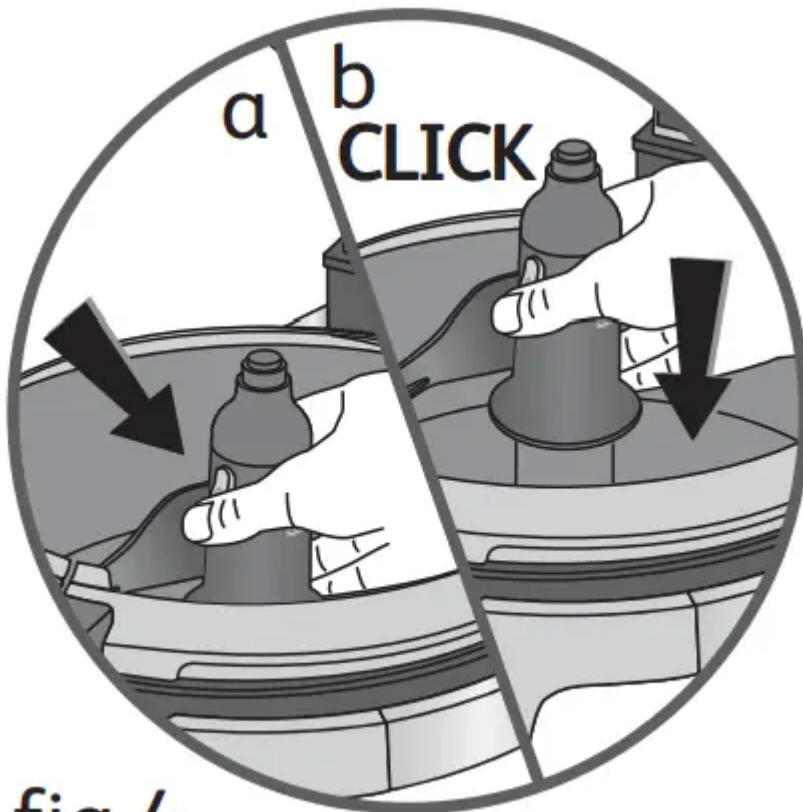

fig.4

- To remove the ring. hold the left side of the ring and press slightly on the securing clip of the right hand side of the ring to release the catch. Separate the two parts of the ring and

extract - fig 5.

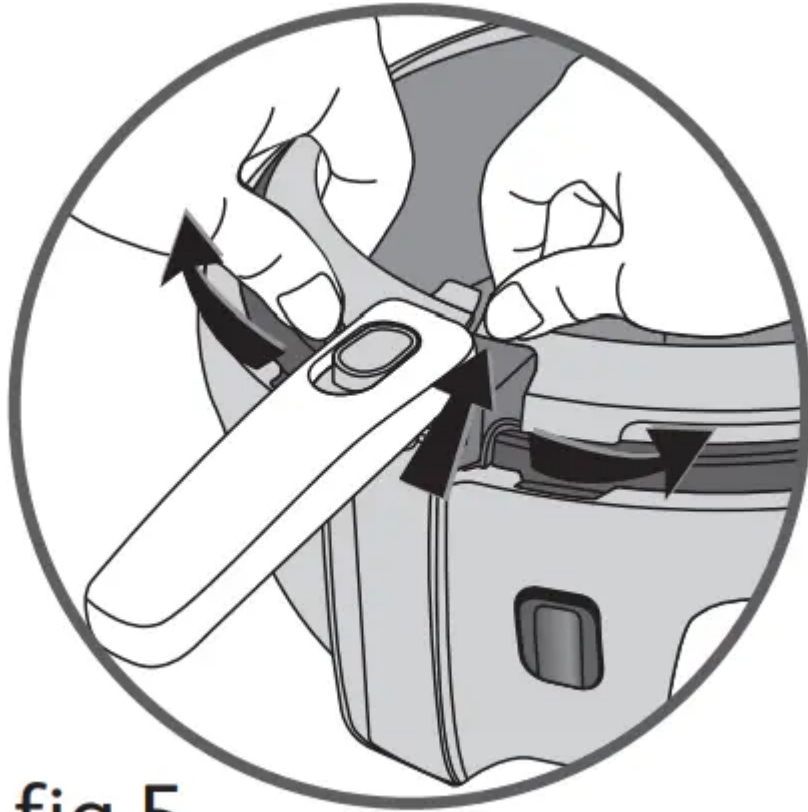

fig.5

- Remove the detachable filter - fig.14.

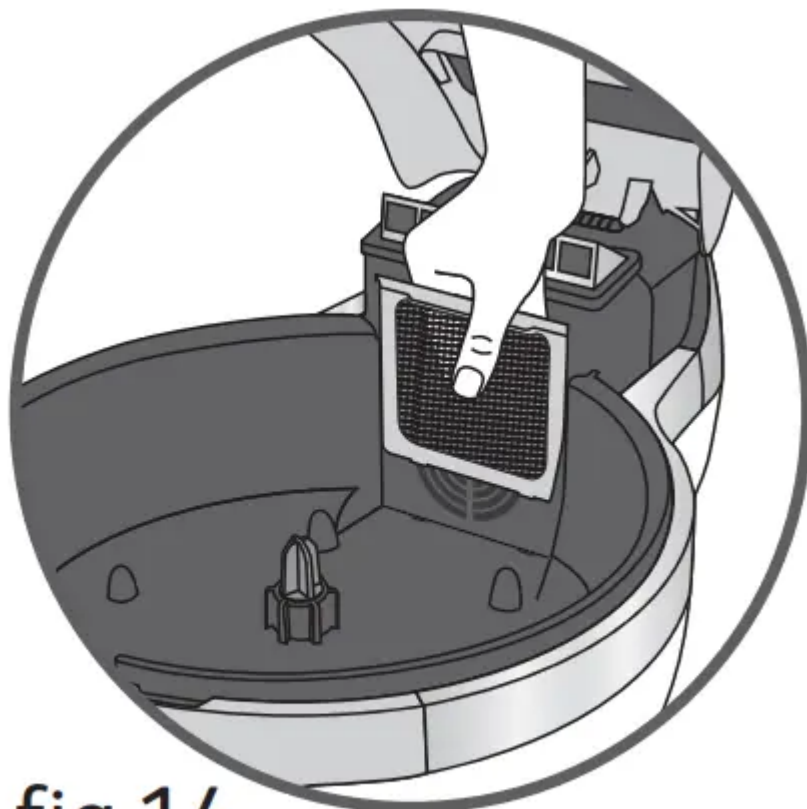

fig.14

- All the removable parts are dishwasher safe - fig.6 or can be cleaned using a non abrasive sponge and some washing up liquid.



fig.6

- Clean the body of the appliance with a damp sponge and a little washing-up liquid.
- Dry carefully before putting everything back in place.
- Place the dismantled ring on the edge of the cooking pan and centre-up the parts. Push the two left and right parts together until these "CLICK" together.

- Reposition the paddle until you hear the "CLICK" - fig.4b.

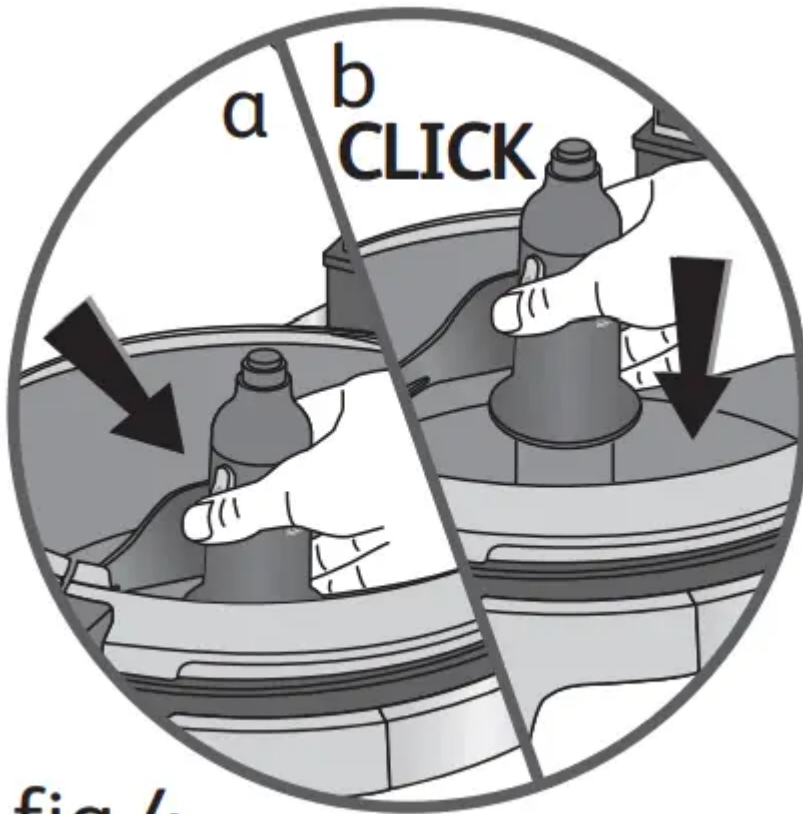

fig.4

- When using for the first time, the appliance may give off a harmless odour. This has no impact on the use of the appliance and will soon disappear.
- In the event of fire, unplug the appliance and smother the flames using a damp tea towel.
- Never move the appliance when it still contains hot food.
- Never immerse your appliance in water!

Preparing the food

To avoid damaging your appliance, please follow the quantities of ingredients and liquids given in the manual and the recipe book. Do not leave the measuring spoon inside the pan while cooking food.

- Open the lid - fig.1.

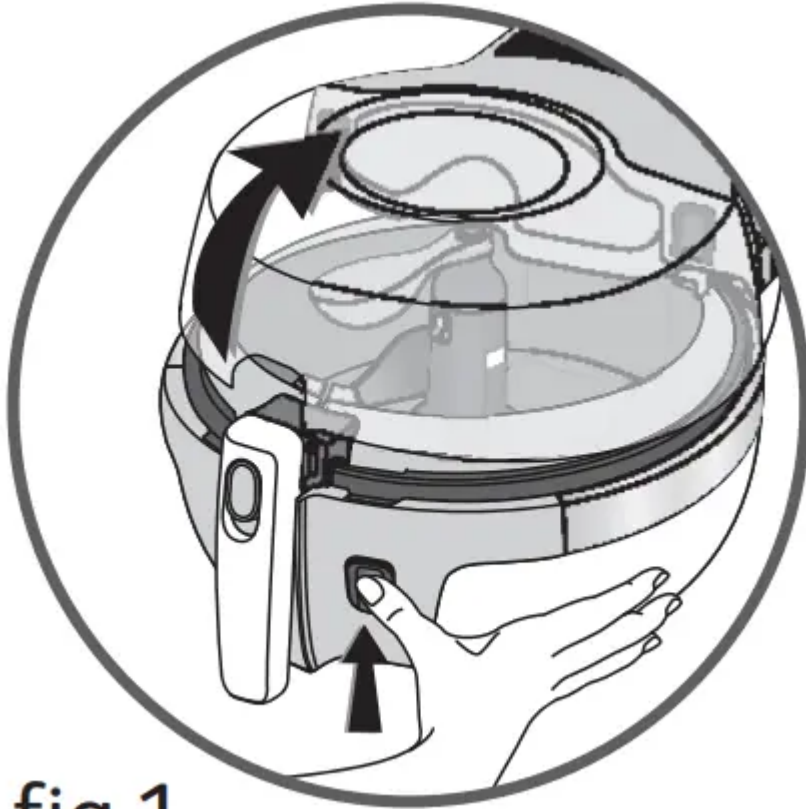

fig.1

- Remove the spoon inside the pan.
- Place the foodstuffs in the cooking pan and always observe the maximum amounts (see cooking table p. 8 to 10) and keep to the recipe instructions - fig.7. Do not alter the

quantities or ingredients used.

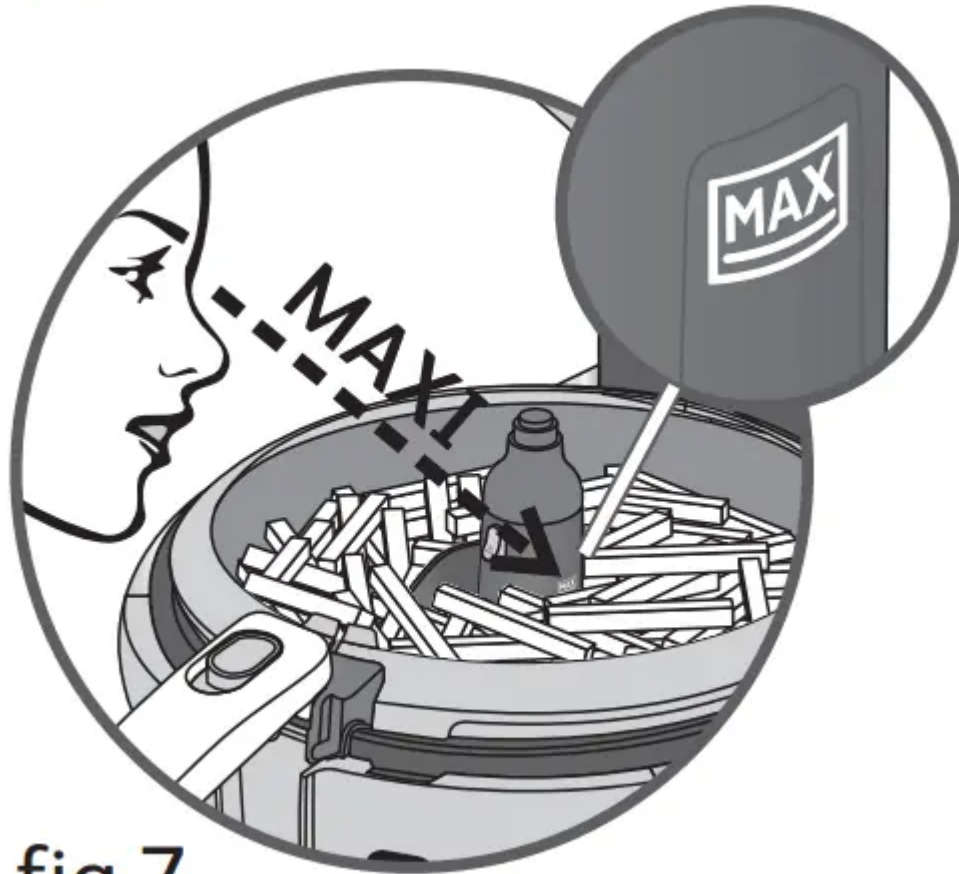

fig.7

- Fill the spoon with the recommended amount of oil (see cooking table p. 8 to 10) and pour the contents evenly onto the food fig.8.



fig.8

- Unlock the handle and push it right back into its housing - fig.9.



fig.9

- Close the lid.

Start cooking

The timer signals the end of cooking. The timer display shows 00 and the appliance automatically stops cooking. To switch off the appliance completely you have to press the on/off button.

- Attach the removable power cord to the appliance and plug it into an earthed electrical outlet - fig.15.

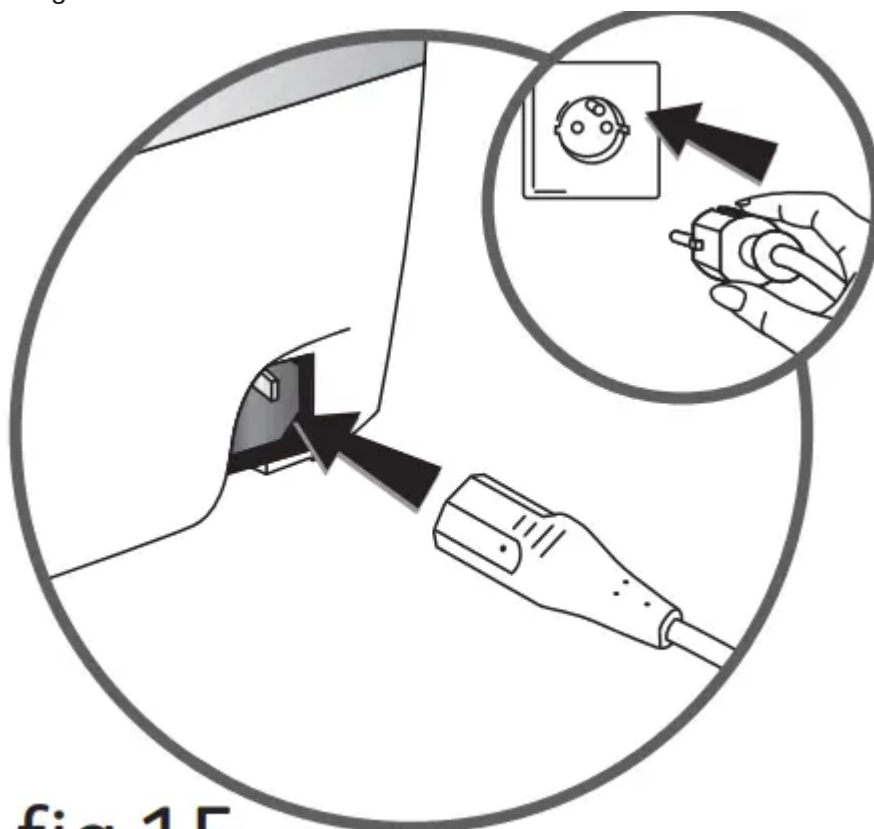

fig.15

- Press the On/Off button; the appliance emits a beep and the screen displays 00 - fig.10.

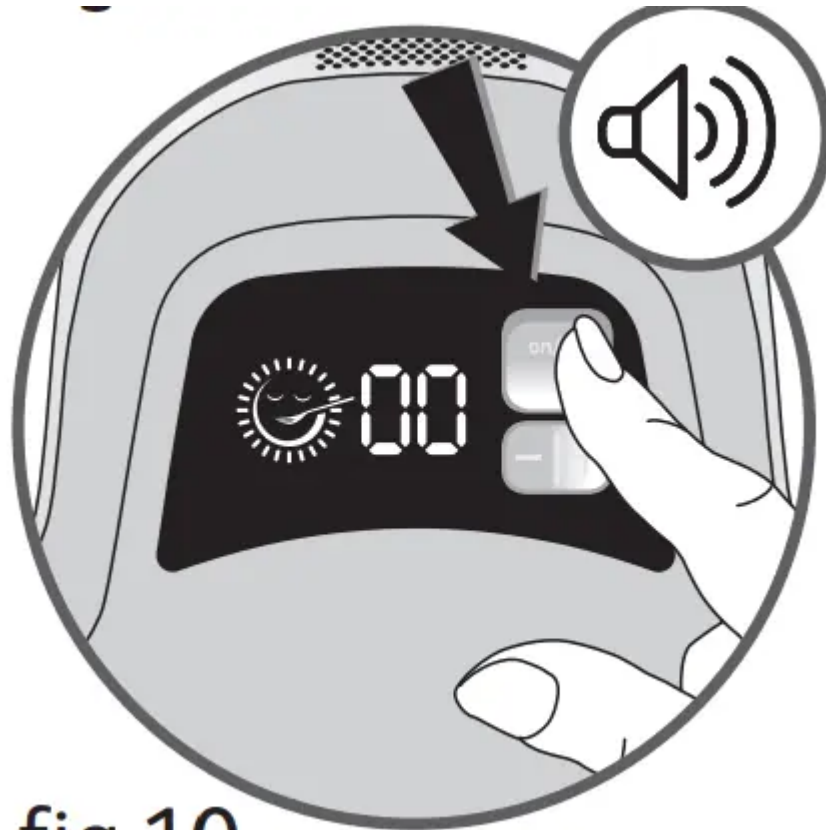

fig.10

- Set the cooking time using the +/- button (see cooking table p. 8 to 10). the appliance emits a second beep - fig.11 and the cooking starts thanks to the movement of hot air

into the cooking chamber.

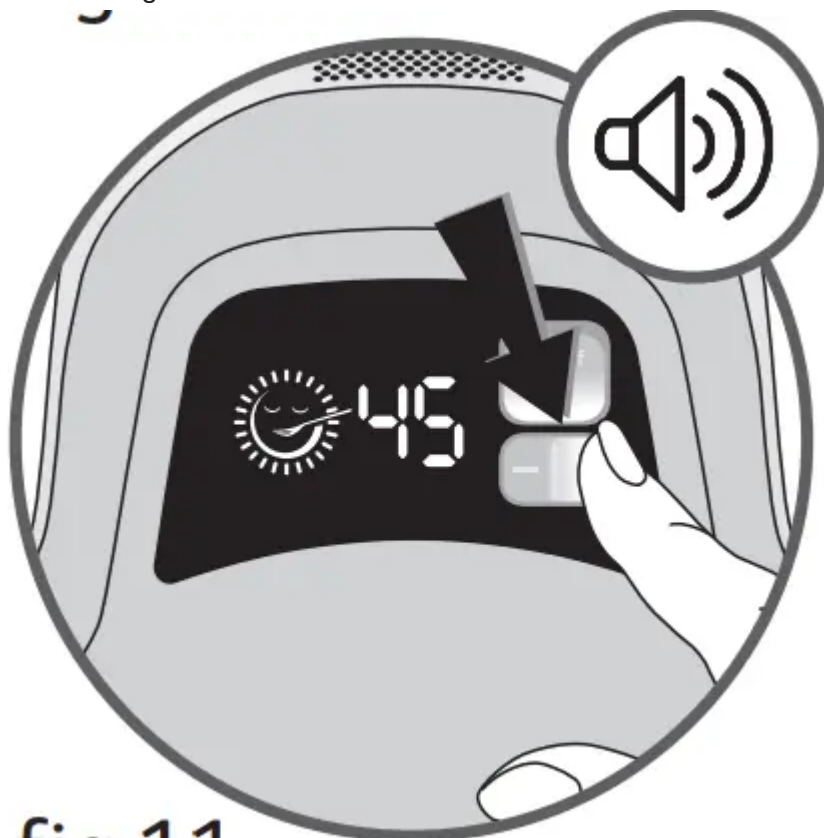

fig.11

- The selected time is displayed and the clock counts down minute by minute - fig.12.



fig.12

The

selection and time displayed is in minutes and only the time displayed below one minute is in seconds.

- In the event of an error or to delete the selected time. hold the button down for 2 seconds and re-select the time. increase or decrease the cooking time with the +/- button.

Remove the food

Opening the lid stops the pulsing of hot air. If the lid remains open for more than 3 minutes the timer is cancelled. Reset the timer.

When the cooking is complete. the timer beeps and the display shows 00: the appliance automatically stops cooking what you have prepared. Stop the beeps by pressing one of the +/- buttons fig.13.

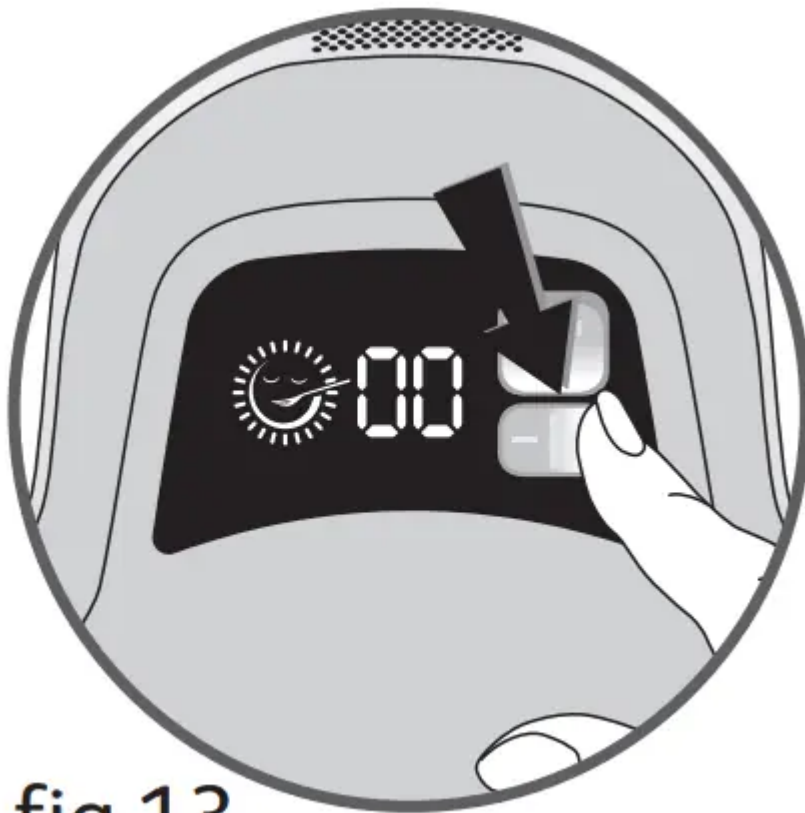

fig.13

Open the lid - fig.1.

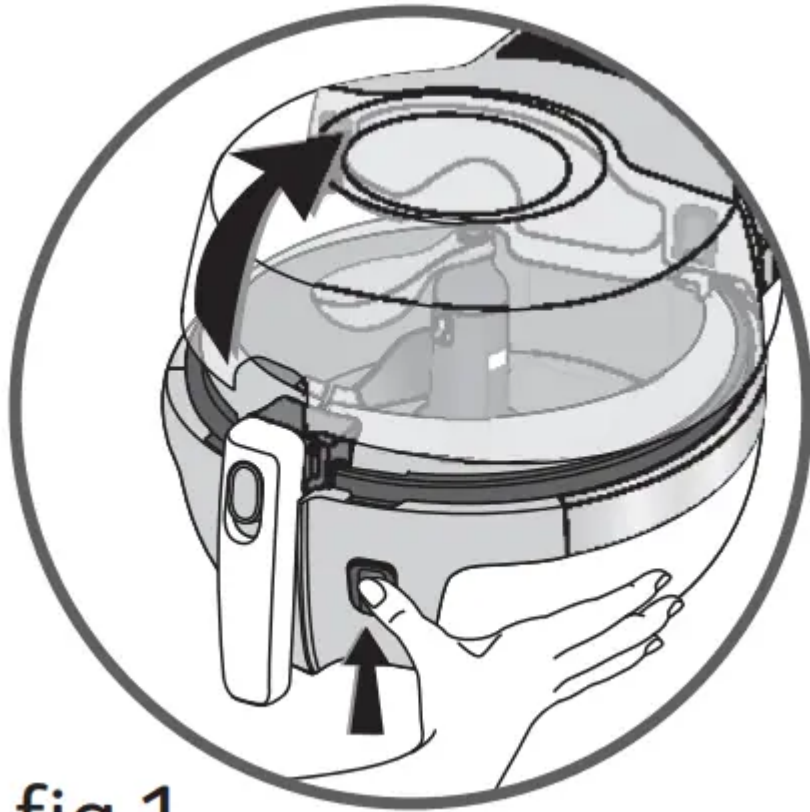

fig.1

Lift the handle until it "CLICKS" to remove the pan and the food.

Cooking times

The cooking times are given as a rough guide and may vary depending on the seasonality of the food, its size, the quantities used and individual tastes, as well as the voltage of the mains system. The amount of oil indicated may be increased depending on your taste and needs.

If you want crisper chips, you can add a few extra minutes to the cooking.

Potatoes

	TYPE	QUANTITY	OIL	COOKING TIME
Standard size chips 10 mm x 10 mm length up to 9 cm*	Fresh	1500 g**	1 spoon of oil	45 min
		1000 g**	¾ spoon of oil	38 min
		750 g**	½ spoon of oil	32 min
		500 g**	⅓ spoon of oil	26 min
		250 g**	⅓ spoon of oil	22 min
Standard Size Frozen Chips 10 mm x 10 mm***	Frozen	1200 g	without	40 min
		750 g	without	27 min

* For UK style thicker chips cut 13 mm x 13 mm increase the cooking time slightly.

** Weight of unpeeled potatoes.

*** For American Style Thin Cut Frozen Chips (8 mm x 8 mm) cook for the same time as 10 mm x 10 mm frozen chips.

Other vegetables

	TYPE	QUANTITY	OIL	COOKING TIME
Courgettes	Fresh in slices	1200 g	1 spoon of oil + 150 ml cold water	30 min
Peppers	Fresh in slices	1000 g	1 spoon of oil + 250 ml cold water	25 min
Mushrooms	Fresh in quarters	1000 g	1 spoon of oil	20 min
Tomatoes	Fresh in quarters	1000 g	1 spoon of oil	20 min
Onions	Fresh in round slices	750 g	1 spoon of oil	30 min

Meat - Poultry

To add a little flavour to your meat, don't hesitate to mix spices in with the oil (paprika, curry, mixed herbs, thyme, bay leaf, etc).

	TYPE	QUANTITY	OIL	COOKING TIME
Chicken nuggets	Fresh	1200 g	without	20 min
	Frozen	1200 g	without	20 min
Chicken legs	Fresh	3	without	30 min
Chicken drumsticks	Fresh	9	without	35 min
Chicken breast (boneless)	Fresh	9 breasts (about 1200g)	without	25 min
Spring Rolls	Fresh	12 small	1 spoon of oil	12 min
Lamb chops	Fresh (2.5 cm to 3 cm thick)	8	1 spoon of oil	20 min*
Minced beef	Fresh	900 g	1 spoon of oil	15 min
	Frozen	600 g	1 spoon of oil	15 min
Meat balls	Frozen	1200 g	1 spoon of oil	20 min
Sausages	Fresh	8 to 10 (pricked)	none	12 min

* Cook longer for well done meat.

Fish - Shellfish

	TYPE	QUANTITY	OIL	COOKING TIME
Battered calamari	Frozen	500 g	without	14 min
Prawns	Cooked	600 g	without	8 min
King prawns	Frozen and thawed	450 g	without	10 min

Desserts

	TYPE	QUANTITY	OIL	COOKING TIME
Bananas	In slices	700 g (7 bananas)	1 spoon of oil + 1 spoon of brown sugar	6 min
	Wrapped in foil packets	3 bananas	without	20 min
Apples	Cut in half	5	1 spoon of oil + 2 spoons of sugar	12 min
Pears	Cut in pieces	1500 g	2 spoons of sugar	12 min
Pineapple	Cut into pieces	2	2 spoons of sugar	17 min

Frozen food

	TYPE	QUANTITY	OIL	COOKING TIME
Ratatouille*	Frozen	1000 g	without	32 min
Pasta and fish*	Frozen	1000 g	without	22 min
Country-style fry*	Frozen	1000 g	without	30 min
Savoyard fry*	Frozen	1000 g	without	25 min
Pasta carbonara*	Frozen	1000 g	without	20 min
Paella*	Frozen	1000 g	without	20 min
Cantonese rice*	Frozen	1000 g	without	20 min
Chilli con Carne meat only	Frozen	1000 g	without	15 min

* Not available in the UK.

ActiFry cooking hints and tips

- Do not add salt to chips while the chips are in the pan. Only add salt once the chips are removed from the appliance at the end of cooking.
- When adding dried herbs and spices to ActiFry, mix them with some oil or liquid. If you try sprinkling them directly into the pan they will just get blown around by the hot air system.
- Please note that strong coloured spices and strong coloured foods such as tomatoes, may slightly stain the paddle and parts of the appliance. This is normal.
- For best results, use finely chopped garlic instead of crushed garlic to avoid it adhering to the central paddle.
- If using onions in ActiFry recipes, they are best thinly sliced instead of chopped as they cook better. Separate the onion rings before adding them to the pan and give them a quick stir so that they are evenly distributed.
- With meat and poultry dishes, stop the appliance and stir the pan once or twice during cooking so that the food on top does not dry out and the dish thickens evenly.
- Prepare vegetables in small pieces or stir fry size to ensure they cook through.
- This appliance is not suitable for recipes with a high-liquid content (eg. soups, cook-in sauces...).

Easy to clean

Clean the appliance

- Leave it to cool completely before cleaning.

- Open the lid by pressing the button - fig.1 and push the lid locks (2) outward to remove the lid - fig.2.

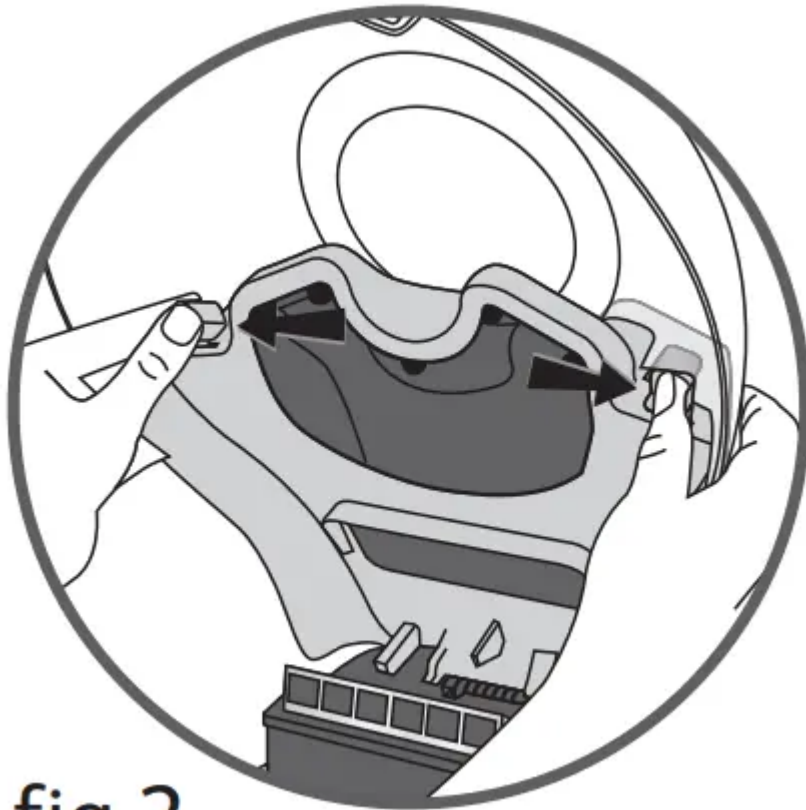

fig.2

- Lift the detachable pan handle until you hear a "CLICK", in order to remove the pan - fig. 3.

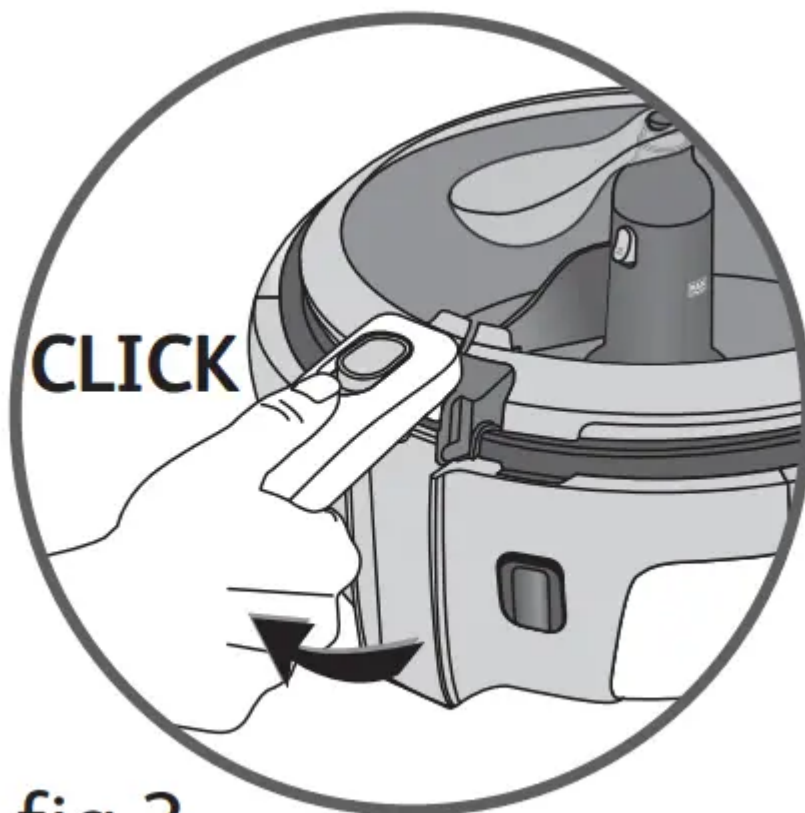

fig.3

- Remove the paddle by pushing the release button - fig.4a.

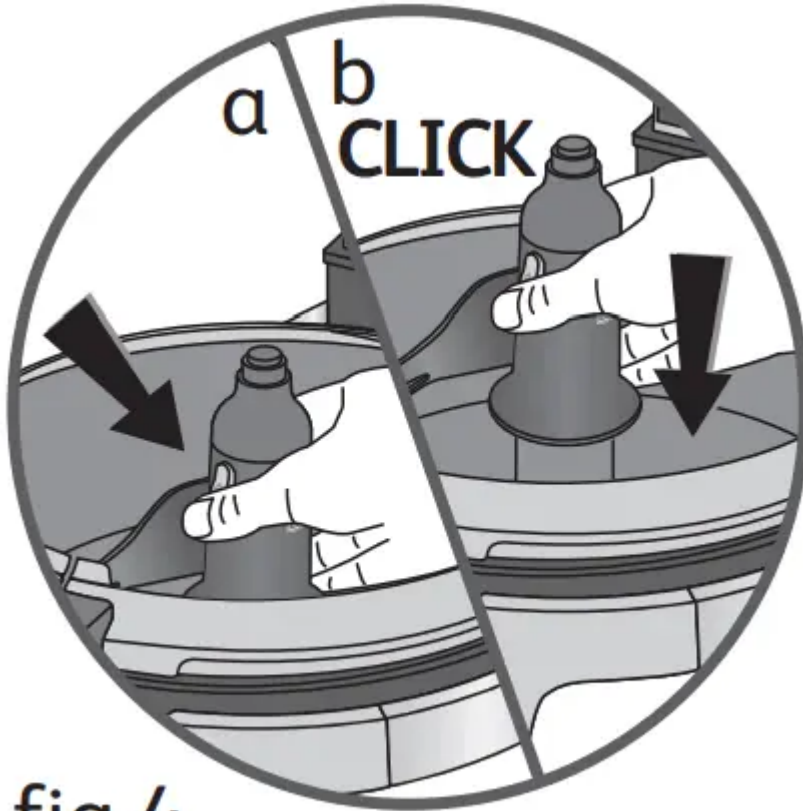

fig.4

- To remove the ring, push the two sides of the ring apart by gently pushing the right-hand side, then pull it free - fig.5.

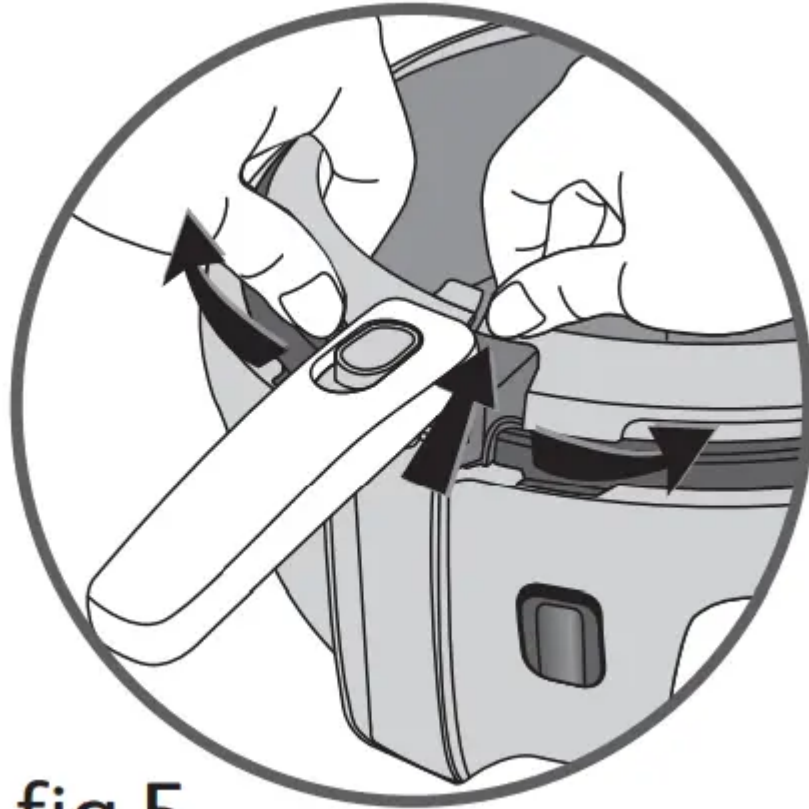

fig.5

- Remove the detachable filter - fig.14.

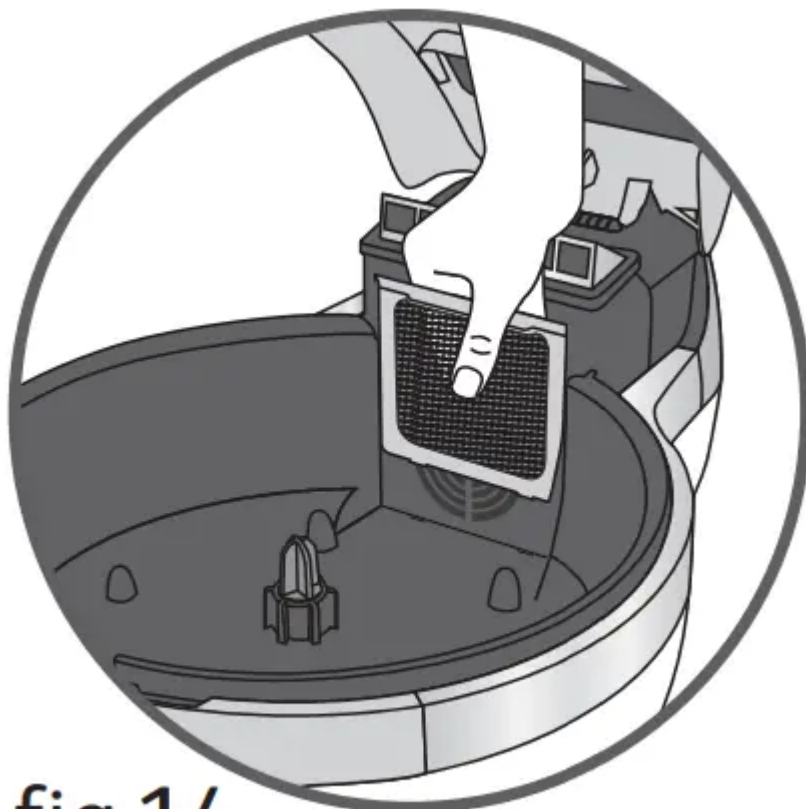

fig.14

- All the removable parts are dishwasher safe - fig.6 or can be cleaned using a non abrasive sponge and some washing up liquid.



fig.6

- Clean the body of the appliance with a damp sponge and a little washing-up liquid.
- Dry carefully before putting everything back in place.
- We guarantee that the detachable pan COMPLIES WITH REGULATIONS with regards to materials in contact with food.
- The pan has a natural coating that is highly resistant, durable and scratch resistant.
- If food gets stuck onto the paddle or pan, leave them to soak in warm water before cleaning (Recyclable ceramic coated removable pan, highly scratch resistant).

Never immerse the appliance in water. Do not use any corrosive or abrasive cleaning products. The removable filter must be cleaned regularly. To ensure the qualities of your removable pan last longer, never use any metal utensils.

A few tips in case of problems...

PROBLEMS	CAUSES	SOLUTIONS
The appliance does not work.	The appliance is not plugged in properly.	Make sure the appliance is properly connected.
	You have not pressed the ON / OFF button.	Press the ON / OFF button.
	You have pressed the ON / OFF button but the appliance is not working.	Close the lid.
	The appliance is not heating.	Take the appliance to an Authorised Service Centre.
	The paddle does not turn.	Check that it is inserted in the correct position, otherwise take the appliance to an Authorised Service Centre.
The paddle does not stay in place.	The paddle is not locked.	Reposition the paddle until you hear it "CLICK" - fig.4b.
The food has not been cooked uniformly.	You have not used the paddle.	Put it in position.
	The food has not been cut uniformly.	Cut the food all to the same size.
	The chips have not been cut uniformly.	Cut the chips all to the same size.
	The paddle has been fitted correctly but is not turning.	Take the appliance to an Authorised Service Centre.

The chips are not crunchy enough.	You are not using a potato variety that is recommended for chips.	Choose a potato variety that is recommended for chips.
	The potatoes are insufficiently washed and/or not completely dried.	Wash potatoes for a long time to remove the starch, drain and dry very thoroughly before cooking.
	The chips are too thick.	The maximum chip thickness is 13 mm x 13 mm. Cut them more thinly.
	There is not enough oil.	Increase the amount of oil (see cooking table on p. 8 to 10).
	The filter is clogged.	Clean the filter.
The chips break during cooking.	The quantity is too large.	Reduce the amount of potatoes and adjust the cooking time.
	The potatoes used are newly harvested and hence have a high water content.	Choose a potato variety recommended for chips.
The food stays on the edge of the pan.	The pan has too much food.	Comply with the amount shown on the cooking table. Put the turn-over ring in place. Reduce the amount of food.
	Max level exceeded.	Reduce the quantities.
Cooking fluids have leaked into the base of the appliance.	Faulty pan or paddle.	Check that the paddle is correctly positioned, otherwise take the appliance to an Authorised Service Centre.

	The max level has been exceeded.	Observe the max level. Do not use ActiFry for making recipes with a high liquid content.
The LCD screen does not work.	The appliance is not plugged in.	Plug the appliance in.
	The lid is open.	Close the lid.
	The appliance has not been started.	Press the ON / OFF button.
The LCD displays shows "Er" (error).	The appliance is not functioning correctly.	Unplug the appliance, wait 10 seconds, plug the appliance, press the ON / OFF button. If the LCD displays still shows "Er"(error), take the appliance to an Authorised Service Centre.
The appliance is abnormally noisy.	You suspect there is a problem in the way the appliance motor is working.	Take the appliance to an Authorised Service Centre.

Warning

This content is compiled from multiple sources and is provided for reference purposes only. It may not be complete or fully applicable to all situations. If you are unable to resolve your issue, please contact the product manufacturer or an authorized service provider for official support.