

## Installation

### What's included

Make sure all the parts are included in the product package. If you have a problem with the washer or the parts, contact the Samsung customer care center or the retailer.

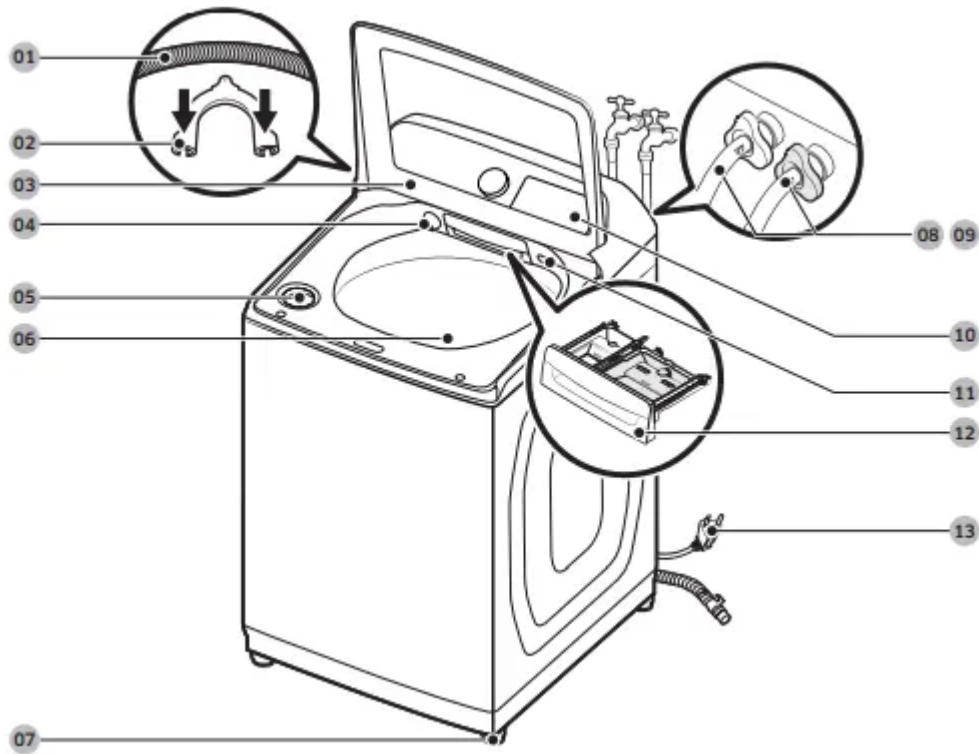

**01** Drain hose

**02** Hose guide

**03** Lid

**04** Active Waterjet nozzle

**05** Bleach compartment

**06** Tub

**07** Leveling feet

**08** Water hose (Cold)

**09** Water hose (Hot)

**10** Control panel

**11** Active Waterjet button

**12** Detergent drawer

## 13 Power cord

### Step-by-step installation

#### STEP 1 Select a location

Location requirements:

- A solid, level surface without carpeting or flooring that may obstruct ventilation
- No direct sunlight
- Adequate room for ventilation and wiring
- Ambient temperature always higher than the freezing point (32 °F / 0 °C)
- Away from heat sources

#### STEP 2 Connect the water hose

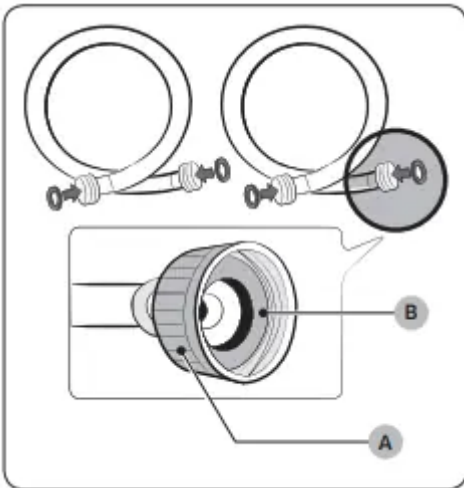

- Attach the water hoses to the hot and cold water taps, and then hand tighten the water hose fittings until they are tight. Then, use pliers to tighten the fittings by an additional two-thirds of a turn. To avoid damaging the fittings, do not overtighten them.
- Pull the water hoses to check if they are firmly connected.

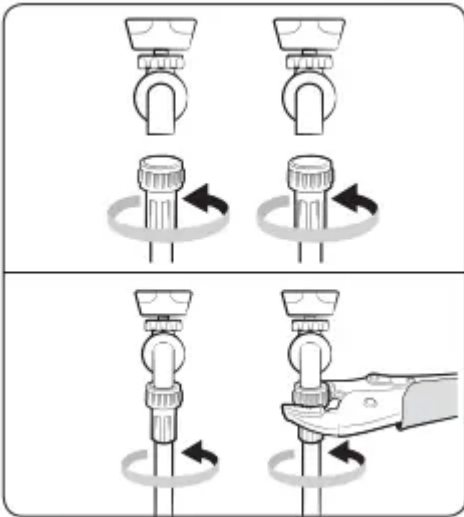

- Put the other ends of the hoses into a bucket, and then open the water taps for 10 - 15 seconds to remove impurities. When done, close the taps.



- Attach the water hoses to the hot and cold water inlets on the back of the washer, and then hand tighten the water hose fittings until they are tight. Then, use pliers to tighten the fittings by an additional two-thirds of a turn.

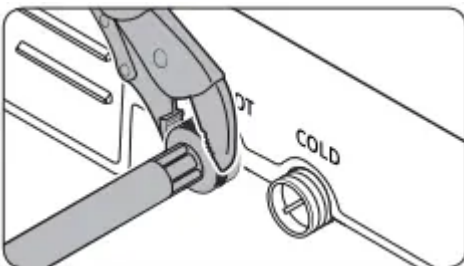

- Open the water taps, and check for leaks.

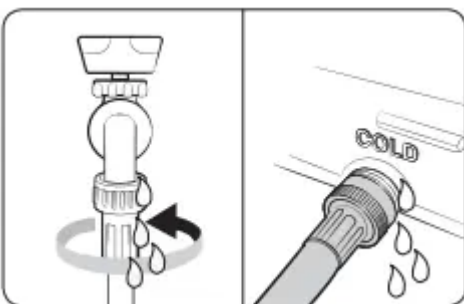

### STEP 3 Connect the drain hose

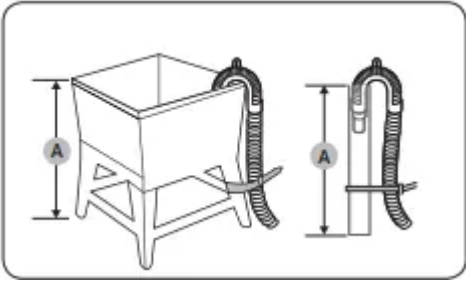

- Check the height (A) of your drain system and make sure the minimum and maximum heights shown below are met.
- Attach the drain hose to the plastic hose guide (B).

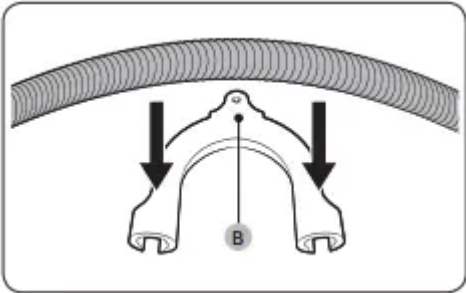

- Route the drain hose to the drain system.

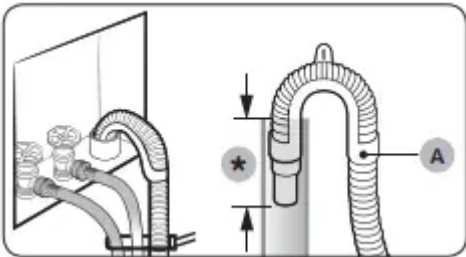

(\*): Min. 6 in. (152 mm), Max. 8 in. (203 mm)

- Secure the drain hose with cable ties

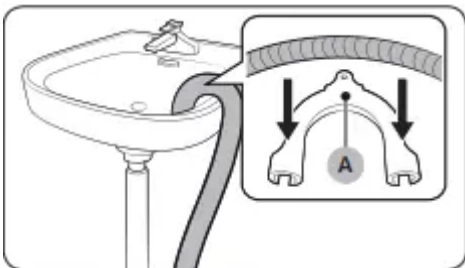

### Over the edge of a wash basin

- The drain hose must be placed at a height of between 24 in. (60 cm) and 35 in. (90 cm) from the floor. To keep the spout of the drain hose bent, use the supplied plastic hose guide (A). Secure the guide to the wall using a hook to ensure stable drainage.

### STEP 4 Level the washer

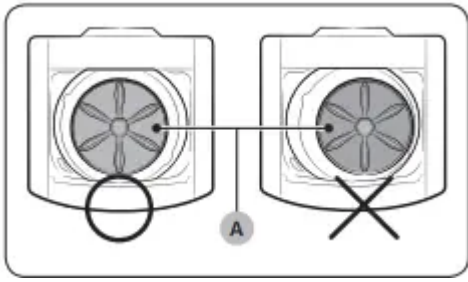

- Slide the washer into position.
- Open the lid and check the pulsator. If the washer is level, the pulsator (A) will be positioned at the center of the tub.

### **STEP 5 Power on**

- Plug the power cord into an AC 120 V / 60 Hz approved electrical outlet protected by a 15-amp fuse or circuit breaker. Then, press Power to turn on the washer.

### **STEP 6 Run a test cycle**

Run a test cycle as follows to check if your washer is properly installed.

1. Load about 6 lb. of laundry into the tub.
2. Press Power to turn on your washer.
3. Turn the Cycle Selector to RINSE+SPIN.
4. Press and hold Start/Pause (Hold to Start) to start the test cycle.
5. The washer should not rock or vibrate excessively during water supply, washing, spinning, and water should drain well during spinning process.

### **NOTE**

- If water leaks while water is being supplied or drained, check the water connections. See the “STEP 2 Connect the water hose” section on page 19.
- If the washer rocks and vibrates excessively, level your washer again. See the “STEP 4 Level the washer” section on page 22.

## **Laundry guidelines**

### **STEP 1 Sort**

Sort the laundry according to these criteria:

- Care label: sort the laundry into cottons, mixed fibers, synthetics, silks, wools, and rayon.
- Color: Separate whites from colors.
- Size: Mixing different sized items together in the tub improves washing performance.
- Sensitivity: Wash delicate items separately. For pure new woolen items, curtains, and silk items, check the labels on the items.

## **STEP 2 Empty pockets**

Empty all the pockets of your laundry items

- Metal objects such as coins, pins, and buckles on clothing may damage other laundry items such as well as the tub.

Turn clothing with buttons and embroideries inside out

- If pants or jacket zippers are open while washing, the tub may be damaged. Zippers should be closed and fixed with a string.
- Clothing with long strings may become entangled with other clothes. Make sure to tie the strings before starting the wash.

## **STEP 3 Use a laundry net**

- Brassieres (water washable) must be placed in a laundry net. Metal parts of the brassieres may break through and tear other laundry items.
- Cashmilon, large volume items, and lightweight clothes (lace-decorated clothes, lingerie, nylon stocking, and synthetic fabrics) may float on water during washing and cause problems to the washer. Use the laundry net or wash them separately.
- Do not wash the laundry net by itself without other laundry. This may cause abnormal vibrations that could move the washer and result in injury.

## **STEP 4 Prewash (if necessary)**

- To remove stains and dirt on collars, sleeves, hems, and pockets, apply detergent lightly and brush off.
- Use powder or liquid detergents. Do not use soap, as this may remain on the tub after washing.
- Prewash white socks, sleeves, and collars with a little detergent and a brush.

## **STEP 5 Determine the load capacity**

- Make sure the laundry does not exceed the plastic area of the tub. Otherwise, it may cause the washing machine to not wash properly or cause damage to the machine or the laundry itself, or a water leak.

### **NOTE**

- When washing bedding or bedding covers, the wash time may be lengthened or the spin efficiency may be reduced.
- For bedding or bedding covers, the recommended load capacity is 3.5 kg or less.

## STEP 6 Add the correct detergent type

- The type of detergent depends on the type of fabric (cotton, synthetic, delicate items, wool), color, wash temperature, and degree of soiling. Always use “low suds” HE laundry detergent which is designed for automatic washers.

### NOTE

- Follow the detergent manufacturer’s recommendations based on the weight of the laundry, the degree of soiling, and the hardness of the water in your local area. If you are not sure about the water hardness, contact your local water authority.
- Do not use detergent that tends to harden or solidify. This detergent may remain after the rinse cycle, blocking the drain outlet.

## Before you start

### To add washing agents to the detergent drawer

- Open the lid.
- Slide open the detergent drawer.
- Add liquid laundry detergent to the liquid detergent container in the main wash compartment.

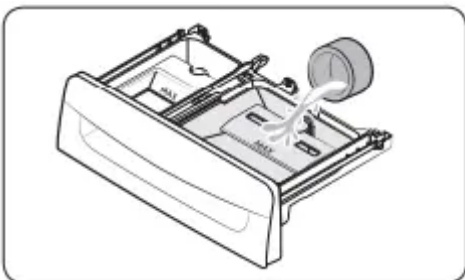

- Add fabric softener to the softener compartment.
- Close the detergent drawer.

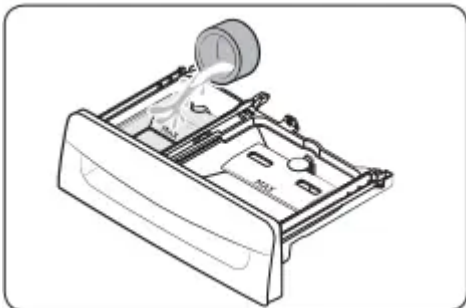

### NOTE

- Do not exceed the max line when applying the cleaning agents.

- It is normal for a small amount of water to remain in the detergent compartments at the end of the cycle.
- When adding color-safe bleach, it is recommended to use liquid detergent.

### To use powdered detergent

First, remove the provided liquid detergent container from the detergent compartment. Then, add powdered detergent to the detergent compartment according to the detergent manufacturer's instructions.

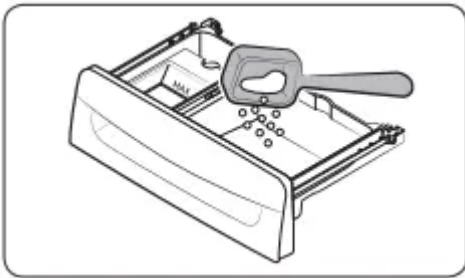

### To use the bleach compartment

Add only liquid chlorine bleach to the bleach compartment. Do not exceed the max line.

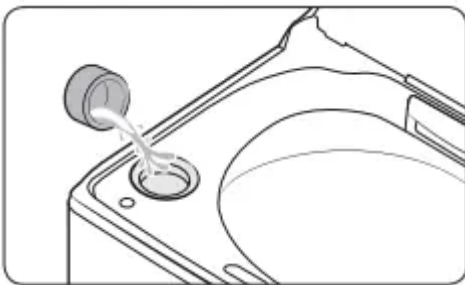

## Control panel

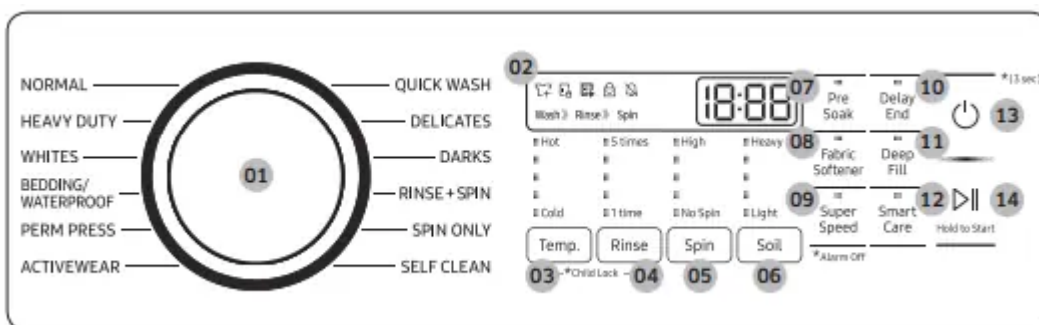

### 01 Cycle Selector

- Turn the dial to select a cycle. (For more information about wash cycles, see page 38.)

### 02 Display

- The display shows current cycle information and estimated time remaining, or an information code if the washer needs to be checked.

### 03 Temp

Press to change the water temperature for the current cycle.

- Hot (Level 5): Heavily soiled, colorfast items.
- (Level 4): Whites and heavily soiled, colorfast items.
- (Level 3): Colorfast items.
- (Level 2): Brightly colored, very lightly soiled items.
- Cold (Level 1): Uses only cold water without utilizing the washer's the heater. No warm water is supplied.

### 04 Rinse

Press to change the rinse count for the current cycle.

- You can select 1 to 5 rinses.

### 05 Spin

Press to change the spinning speed for the current cycle.

- High (Level 5): Extends the spinning process to effectively remove moisture from the load. This level uses a stronger spinning process to remove moisture, so it is not suitable for wrinkle-free or non-iron fabrics, or overloads.
- (Level 4): Underwear, t-shirts, jeans, and sturdy cottons.
- (Level 3): Jeans, wrinkle-free or wash-and wear items, and synthetics.
- (Level 2): Delicate items that require a lower spinning speed.
- No Spin (Level 1): The drum does not spin after the final drain process.

Rinse hold (All indicators are off): The final rinse process is suspended so that the laundry remains in the water. To unload the laundry, run a drain or spin process.

### 06 Soil

Press to change the soil level for the current cycle.

- Heavy (Level 5): For extremely soiled loads.
- (Level 4): For heavily soiled loads.
- (Level 3): For moderately soiled loads. This setting is best for most loads.
- (Level 2): For lightly soiled loads.
- Light (Level 1): For barely soiled loads.

### 07 Pre Soak

- Press to add 18 minutes of soaking time at the start of the wash cycle for better stain removal.

## 08 Fabric Softener

- Press to add an additional rinse at the end of the cycle for more thorough removal of laundry additives and perfumes.

## 09 Super Speed

- Press to shorten the washing time for NORMAL, HEAVY DUTY or WHITES. Shortened time may differ depending on the cycle, load, and options.

## 10 Delay End

- Set the washer to finish your wash automatically at later time. Choose a delay of between 1 to 24 hours (in 1 hour increments). (For more information about Delay End, see page 41.)

## 11 Deep Fill

Use this option where extra water is needed.

- NOTE The cycle time will be extended when you use this function.

## 12 Smart Care

- This function enables you to check the status of the washer using a smartphone.

## 13 Power

- Press to turn the washer on or off

## 14 Start/Pause (Hold to Start)

- Press and hold to start operation or press to stop operation temporarily.

## Simple steps to start

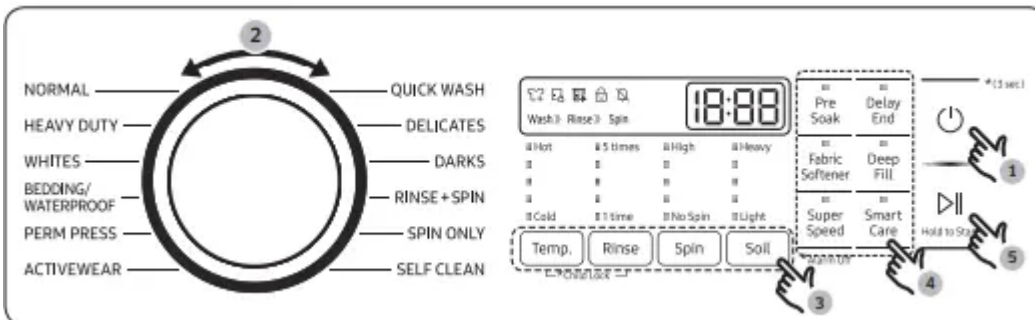

1. Press Power to turn on the washer.
2. Turn the Cycle Selector to select a cycle.
3. Change the cycle settings (Temp., Rinse, Spin, and Soil) as necessary.
4. Select desired options as necessary.
5. Press and hold Start/Pause (Hold to Start).

## To change the cycle during operation

1. Press Start/Pause (Hold to Start) to stop operation.
2. Select a different cycle, and repeat steps 2-3 above if necessary.
3. Press and hold Start/Pause (Hold to Start) again to start the new cycle.

## Operations

### Cycle overview

#### NORMAL

- For cottons, bed linens, table linens, underwear, towels, or shirts. The washing time and the number of rinses are automatically adjusted according to the load.

#### HEAVY DUTY

- For sturdy, colorfast fabrics, heavily soiled items.

#### WHITES

- For white items. You can wash with or without bleach.

#### BEDDING/ WATERPROOF

- For bulky and large items, such as comforters, blankets, and sheets, and waterproof or water resistant items. When washing comforters, use liquid detergent.

### CAUTION

- Do not wash waterproof items and non-waterproof items together.
- Check the specification label on each item to see if the item is waterproof.
- Use the BEDDING/WATERPROOF cycle for waterproof or water-resistant items such as plastic mats, ski pants, raincoats, and comforters which hardly absorb water.

#### PERM PRESS

- For wash-and-wear, synthetic fabrics, and lightly to normally soiled items.

#### ACTIVEWEAR

- For exercise wear such as sports jerseys, training pants, shirts/tops and other performance clothing. This cycle provides effective soil removal with gentle action for special fabric care.

#### QUICK WASH

- For lightly soiled garments needed quickly.
- For best performance, recommended load is 4 lb. or lower.

## DELICATES

- For sheer fabrics, bras, lingerie (silk), and other handwashonly fabrics.
- For best performance, use liquid detergents.

## DARKS

- For loads that needs rinsing and spinning only.
- You can also select this cycle for additional rinsing and spinning process after running other cycle.

## SPIN ONLY

- For loads that needs spinning only.
- You can also select this cycle for additional spinning process after running other cycle.

## SELF CLEAN

- Cleans the drum by removing dirt and bacteria from the drum.
- Perform once every 20 washes with no detergent or bleach added.
- Make sure the drum is empty

## Cycle chart

Setting	Temp.	Rinse	Spin	Soil
● : factory setting	5: Hot (Level 5)	5: 5 times (Level 5)	5: High (Level 5)	5: Heavy (Level 5)
○ : can be selected	4: (Level 4)	4: (Level 4)	4: (Level 4)	4: (Level 4)
	3: (Level 3)	3: (Level 3)	3: (Level 3)	3: (Level 3)
	2: (Level 2)	2: (Level 2)	2: (Level 2)	2: (Level 2)
	1: Cold (Level 1)	1: 1 time (Level 1)	1: No Spin (Level 1)	1: Light (Level 1)

Cycle	Temp.					Rinse				
	5	4	3	2	1	5	4	3	2	1
NORMAL	○	●	○	○	○	○	○	○	○	●
HEAVY DUTY	●	○	○	○	○	○	○	○	○	●
WHITES	●	○	○	○	○	○	○	○	●	○
DELICATES	-	○	○	●	○	○	○	○	○	●
PERM PRESS	○	●	○	○	○	○	○	○	○	●
BEDDING/WATERPROOF	○	●	○	○	○	○	○	○	●	○
QUICK WASH	○	●	○	○	○	○	○	○	○	●
ACTIVE WEAR	-	○	●	○	○	○	○	○	○	●
DARKS	-	○	○	●	○	○	○	○	○	●
RINSE+SPIN	-	-	-	-	-	○	○	○	○	●
SPIN ONLY	-	-	-	-	-	-	-	-	-	-
SELF CLEAN	●	-	-	-	-	-	-	-	-	●

## Active Waterjet (for prewash)

You can use the Active Waterjet function to hand-wash your items before you put them in the washer.

1. Press Power to turn on your washer.
2. Open the lid.
3. Press Active Waterjet to supply water.
4. Hand-wash the items.
5. When done, press Active Waterjet again to stop the water.

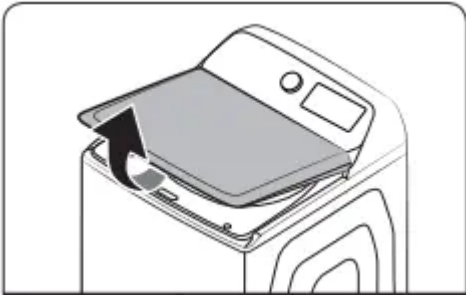

#### NOTE

- If you want to hand-wash while the washer is operating, press Start/Pause (Hold to Start) to stop operation, and then follow steps 1-4 above.



#### NOTE

- The Active Waterjet function stops operating automatically when the washer detects the maximum water level.
- The Active Waterjet function stops operating automatically 5 minutes after it begins. To add more water, press Active Waterjet again to resupply water.
- If the Active Waterjet function is activated immediately after the washer turns on, the washer will spray water for 1 second before supplying water through the Active Waterjet outlet.
- To drain water added by the Active Waterjet function, turn the power off. Water will be drained automatically for few minutes and you can turn the power on again when the water is completely drained.

## CAUTION

- Do not block the Active Waterjet outlet with hands. Water may leak outside the tub, causing a system failure.
- Do not use the Active Waterjet to wash shoes, food, or pets.
- Due to differences in air pressure, water coming from the Active Waterjet may splatter when you first activate it.
- Make sure the lid is closed tightly before you start a load of laundry.

## Delay End

You can set the washer to finish your wash automatically at a later time by choosing a delay of between 1 to 24 hours (in 1 hour increments). The hour displayed indicates the time the wash will finish.

1. Select a cycle. Then, change the cycle settings if necessary.
2. Press Delay End repeatedly until a desired end time is set.
3. Press and hold Start/Pause (Hold to Start).
4. To cancel Delay End, restart the washer by pressing Power.

## Alarm Off

You can turn the alarm sound on or off. When the alarm is off, the cycle completion melody and the power-off beep will not sound. However, button and alert sounds will remain on.

- To mute the sound, press and hold Super Speed for 3 seconds.
- To unmute the sound, press and hold again for 3 seconds.
- Your setting will be kept even after you turn off and then restart the machine.

## ATC (Auto Temperature Control)

- ATC enables the washer to control water temperatures in each washing cycle using the internal thermistor. It is designed to maintain certain washing temperatures for best results.

## NOTE

- If you select NORMAL or HEAVY DUTY, you may notice the washer supplying cold water. This is normal because the machine is designed to reduce power consumption. In these cycles, the water temperature for Level 5 is similar to bath-water temperatures, and Level 3 is similar to comfortable swimming pool temperatures.
- To wash clothes at a specific temperature, you must choose a different cycle first.

## Smart Care

To enable this function, you must first download the Samsung Laundry app from the Play Store or the App Store and install it on a mobile device that has a camera function. The Smart Care function has been optimized for Galaxy and iPhone mobile devices (applicable models only).

1. When the washer detects an issue to check, an information code appears on the display. To enter Smart Care mode, press Smart Care.
2. The washer starts the self-diagnosis procedure and displays an information code if a problem is detected.
3. Run the Samsung Laundry app on your mobile device, and then tap Smart Care.
4. Put the mobile device close to the washer's display so that the smartphone camera and the washer face each other. The information code will be recognized automatically by the app.
5. When the information code is recognized correctly, the app provides detailed information about the problem with applicable solutions.

#### **NOTE**

- The function name, Smart Care, may differ depending on the language.
- If the washer's display reflects light, the app may fail to recognize the information code.
- If the app fails to recognize the information code, you can enter the code manually on the app.

## **Maintenance**

### **Self Clean**

Certain usage and environmental conditions may result in some residue build-up or odor in the washer tub. To prevent this build-up of residue or odor causing bacteria and keep your washer tub fresh and clean, perform the SELF CLEAN cycle at least once a month or every 20 cycles. Perform the recommended procedure below when using the SELF CLEAN cycle.

1. Remove all items from the washer tub and ensure the tub is empty. Laundry left in the tub during the SELF CLEAN cycle may be damaged.
2. Press Power to turn on the washer.
3. Turn the Cycle Selector to SELF CLEAN.
4. Press and hold Start/Pause (Hold to Start).

#### **NOTE**

- The water temperature for SELF CLEAN is defaulted to Hot. This temperature cannot be changed.

- In the case where residue is present in the washer tub, add 1 cup (8 fl.oz, 240ml) of liquid chlorine bleach to the bleach compartment before you start the SELF CLEAN cycle.
- Do not use or mix any other detergent or chemicals during the SELF CLEAN cycle. If necessary, run a RINSE+SPIN cycle after the SELF CLEAN cycle has completed to help remove any remaining residue.

### **SELF CLEAN reminder**

- After 20 washing cycles, the SELF CLEAN LED reminder icon and the SELF CLEAN cycle LED will blink on the control panel for an hour and then turn off automatically.
- The reminder will appear on the control panel for 5 additional consecutive cycles before turning off. The next reminder will not appear until another 20 cycles have been completed.

### **Cleaning the exterior**

1. Turn off the water taps after finishing the day's washing. This will shut off the water supply to your washer and prevent the unlikely possibility of damage from escaping water. Leave the lid open to allow the inside of your washer to dry out.
2. Use a soft cloth to wipe up all detergent, bleach, or other spills as they occur. Clean the following as recommended below:
  - Control Panel – Clean with a soft, damp cloth. Do not use abrasive powders or cleaning pads. Do not spray cleaners directly on the panel.
  - Cabinet – Clean with soap and water.

### **Cleaning the interior**

Clean the interior of your washer periodically to remove any dirt, soil, odor, mold, mildew, or bacterial residue that may remain in your washer as a result of washing clothes.

### **CAUTION**

- Failure to follow these instructions may result in unpleasant conditions, including odors and/or permanent stains on your washer or laundry.

### **NOTE**

- Hard water deposits may be removed, if needed. Use a cleaner labeled "Washer safe".

### **Care for an extended period of non-use**

Avoid leaving the washer unused for an extended time. However, if you intend to leave the washer unused for a long period of time, follow the directions below:

1. Press Power, and then turn the Cycle Selector to QUICK WASH.
2. Empty the drum, and then press and hold Start/Pause (Hold to Start).

3. When the cycle is complete, close the water taps and disconnect the water hoses.
4. Turn off the washer, and then unplug the power cord.
5. Open the door to let air circulate through the drum.

### Cleaning the mesh filter

Clean the mesh filters in the water inlets once or twice a year.

- Turn off the washer, and then unplug the power cord.
- Close the water taps.
- Loosen and disconnect the water hose from the back of the washer. Cover the hose with a cloth or towel to prevent water from gushing out.

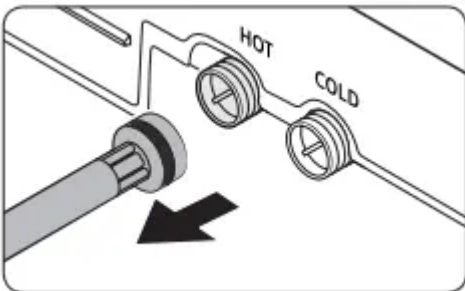

- Use pliers to pull out the mesh filter from the inlet valve.
- Thoroughly clean the mesh filter in water.
- Completely dry the mesh filter. Do not dry in direct sunlight.
- Reinsert the mesh filter, and then reconnect the water hose.
- Open the water tap.

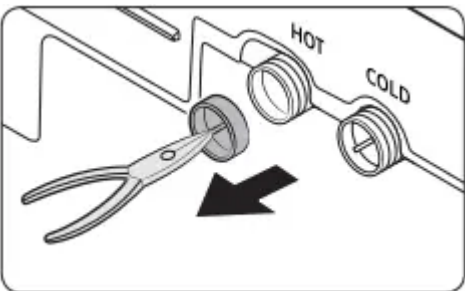

**NOTE** If the mesh filter is clogged, the “4C” information code appears on the washer’s display screen.

### Cleaning the detergent drawer

- Fully pull out the detergent drawer.

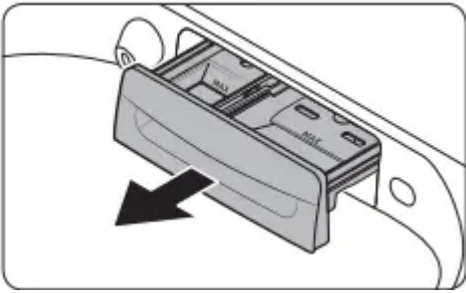

- To remove, pull the detergent drawer while pushing the ends of each side.

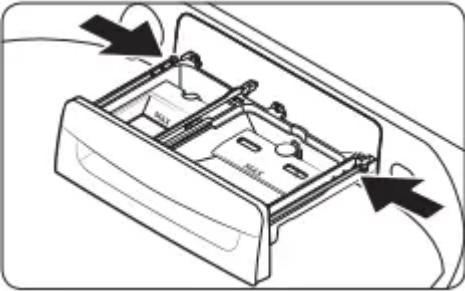

- Remove the inserts from the compartments. Rinse the inserts and the drawer in warm water and clean with a soft brush.

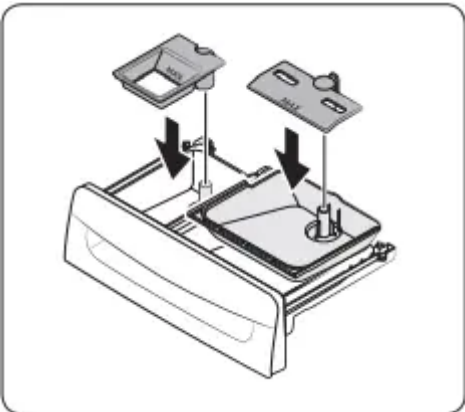

- Clean the drawer opening thoroughly with a small, non-metallic brush.

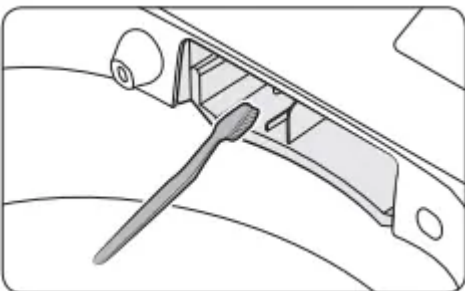

- Return the insert to the proper compartments. Replace the drawer by placing the drawer rail (A) on the compartment rail (B) while tilting the drawer downward.
- Fully push the drawer back to close.

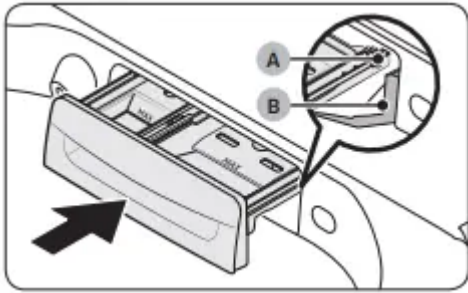

## Troubleshooting

### Checkpoints

If you encounter a problem with the washer, first check the table below and try the suggestions.

Does not turn on.

- Make sure your home electrical system is providing electrical power that matches the requirements of the washer. See page 16.
- Make sure the power cord is completely plugged in.
- Check the fuse or reset the circuit breaker.
- If you have turned the power off to drain the water added by the Active Waterjet function, power does not turn on until the water is completely drained.

Does not start.

- Make sure the door is closed.
- Make sure the water taps are open.
- Make sure to press or tap Start/Pause (Hold to Start) to start the washing machine.
- Make sure Child Lock is not activated.
- Before the washing machine starts to fill, it will make a series of clicking noises to check the door lock, and then does a quick drain.
- Was the door opened during the spinning cycle? Close the door, and then press or tap Start/Pause (Hold to Start) to resume.
- The machine enters Standby or is in a soaking cycle. Please wait.
- Check the fuse or reset the circuit breaker.

Water is not supplied.

- Make sure you press or tap Start/Pause (Hold to Start) after selecting the cycle and options.
- Make sure the water taps are open.
- Are the mesh filters in the water inlets clogged? Clean the mesh filters by brushing with a toothbrush. See page 46.

- Is the water supply cut off? If the water supply is cut off, close the tap and power off.
- Straighten the water supply hoses.
- Open and close the door, and then press or tap Start/Pause (Hold to Start).
- If the water pressure is low, it takes longer to start washing.
- If the water level is not as high as necessary or lower than expected, use the level selector to adjust the water level.

After a cycle, detergent remains in the automatic dispenser.

- Make sure the washing machine is running with sufficient water pressure.
- Make sure the detergent drawer is properly inserted.
- Remove and clean the detergent drawer, and then try again.

Vibrates excessively or makes noise.

- Make sure the washing machine is on a level floor. If the floor is not level, use the levelling feet to adjust the washing machine.
- Make sure the washing machine is not contacting any other object.
- Make sure the laundry load is balanced.
- Make sure the laundry is spread evenly in the washing machine. Spread out the laundry evenly and start again.
- Make sure the space around the washing machine is free of objects.
- Humming is produced normally during operation.
- Objects such as coins can cause noise. Remove these objects from the washing machine after washing is complete.

Stops.

- Plug the power cord into a live electrical outlet.
- Check the fuse or reset the circuit breaker.
- Close the door, and then press or tap Start/Pause (Hold to Start) to start the washing machine. For your safety, the washing machine will not spin unless the door is closed.
- Before the washing machine starts to fill, it will make a series of clicking noises to check the door lock, and then does a quick drain.
- There may be a pause or soak period in the cycle. Wait briefly and the washing machine may start.
- Make sure the inlet hose filters at the taps are not clogged. Periodically clean the filters. See page 47.
- This problem can occur temporarily due to low voltage in your household electrical system. It will be resolved when the voltage returns to normal.

Fills with the wrong temperature water.

- Fully open both water taps.
- Make sure the temperature selection is correct.
- Make sure the hoses are connected to the correct water taps. Flush water lines.
- Disconnect the hoses and clean the mesh filters. The water inlet mesh filters may be clogged. See page 46.
- While the washing machine fills, the water temperature may change as the automatic temperature control feature checks incoming water temperature. This is normal.
- While the washing machine fills, you may notice just hot and/or just cold water going through the dispenser when cold or warm temperatures are selected. This is a normal function of the automatic temperature control feature as the washing machine determines the water temperature.

Door (Lid) locked or will not open.

- While the washing machine is operating, press or tap Start/Pause (Hold to Start) to stop the washing machine.
- It may take a few moments for the door lock mechanism to disengage.

Does not drain and/or spin.

- Check the fuse or reset the circuit breaker.
- Make sure the electrical voltage is normal.
- Make sure the washing machine is plugged in.
- Make sure the drain hose is pointed downward. (Natural drain models only)
- Make sure the drain hose is not clogged.
- Make sure the drain hose is not kinked.
- Straighten the drain hose. If there is a drain restriction, call for service.
- Close the door, and then press or tap Start/Pause (Hold to Start). For your safety, the washing machine will not spin unless the door is closed.

Load is wet at the end of the cycle.

- Use the High or Extra High spin speed cycle. (Applicable model only)
- Use high efficiency (HE) detergent to reduce oversudsing.
- The load is too small. Small loads (one or two items) may become unbalanced and not spin completely.

Leaks water.

- Make sure all hose connections are tight.

- Make sure the water supply hoses' rubber washers are in the correct position. Screw tightly again.
- Make sure the end of the drain hose is correctly inserted and secured to the drain system.
- Avoid overloading.
- Use high efficiency (HE) detergent to prevent oversudsing.
- Make sure the water supply hose is not kinked.
- If the water supply pressure is too strong, water may leak. Close the water tap a little.
- Make sure water is not leaking from the water tap. If it is, repair the water tap

Excessive suds.

- Use high efficiency (HE) detergent to prevent oversudsing.
- Reduce the detergent amount for soft water, small loads, or lightly soiled loads.
- Non-HE detergent is not recommended.

The spin basket or drain/supply hose is frozen.

- Use warm water to disconnect the water supply hose and drain hose. Soak them in warm water.
- Fill the spin basket with warm water, and then wait for about 10 minutes.
- Put a hot towel on the drain hose connector.
- Reconnect the water supply hose and drain hose, and then check if water is supplied properly.

Water drains out immediately.

- Make sure the drain hose is not clogged, and is hung over the drain hose hook. Fill the spin basket halfway with water, and try spinning again.
- Lift the end of the drain hose to prevent water from draining. Fill the spin basket halfway with water, and then run the Spin cycle after releasing the drain hose.
- Make sure the drain hose is installed correctly. See the installation section of this user manual and adjust the position of the drain hose as instructed.

Stains on clothes.

- Select an appropriate cycle for the laundry. Use the HEAVY DUTY cycle for stained clothes.
- Apply a recommended amount of detergent as instructed by the detergent manufacturer.
- Clean the magic filter (if it comes with your washer) on a regular basis.

Has odors.

- Excessive suds collect in recesses and can cause foul odors.

- Run a SELF CLEAN cycle to sanitize periodically.
- Dry the washing machine interior after a cycle has finished.

### **Information codes**

The washer may display information codes to help you understand what is occurring with your washer better.



Code	Meaning
1C	<p>The Water Level sensor is not working properly.</p> <ul style="list-style-type: none"> <li>• Turn off the washer, unplug it, wait 30 seconds, and then plug the washer in again. If the information code remains, contact a Samsung customer service center.</li> </ul> <p><b>NOTE</b> If the washer displays “1C”, the washer will automatically drain for 3 minutes. During this time, the Power button is inoperative.</p>
3C	<p>Check the motor for operation.</p> <ul style="list-style-type: none"> <li>• Try restarting the cycle.</li> <li>• If the problem continues, call for service.</li> </ul>
4C	<p>Water is not supplied.</p> <ul style="list-style-type: none"> <li>• Make sure the water taps are open.</li> <li>• Make sure the water hoses are not clogged.</li> <li>• Make sure the water taps are not frozen.</li> <li>• Make sure the washing machine is operating with sufficient water pressure.</li> <li>• Make sure that the cold water tap and the hot water tap are properly connected.</li> <li>• Clean the mesh filter as it may be clogged.</li> </ul> <p><b>NOTE</b> If the washer displays “4C”, the washer will automatically drain for 3 minutes. During this time, the Power button is inoperative.</p>
4C2	<ul style="list-style-type: none"> <li>• Make sure the cold water supply hose is firmly connected to the cold water tap. If it is connected to the hot water tap, laundry may be damaged when some cycles are run.</li> </ul>
5C	<p>Water is not draining.</p> <ul style="list-style-type: none"> <li>• Make sure the drain hose is not frozen or clogged.</li> <li>• Make sure the drain hose is positioned correctly, depending on the connection type.</li> <li>• Clean the mesh debris filter as it may be clogged.</li> <li>• Make sure the drain hose is straight all the way to the drain system.</li> </ul>



	<ul style="list-style-type: none"> <li>• Turn off the washer, unplug it, wait one minute, and then plug the washer in again. If the information code remains, contact a Samsung customer service center.</li> </ul>
9C1	<p>The electronic control needs to be checked (Over Voltage Error).</p> <ul style="list-style-type: none"> <li>• Check if power is supplied properly.</li> <li>• Turn off the washer, unplug it, wait one minute, and then plug the washer in again. If the information code remains, contact a Samsung customer service center.</li> </ul>
9C2	<p>Low voltage detected.</p> <ul style="list-style-type: none"> <li>• Check if the power cord is plugged in.</li> <li>• Turn off the washer, unplug it, wait one minute, and then plug the washer in again. If the information code remains, contact a Samsung customer service center.</li> </ul>
AC6	<p>Inverter Communication problem.</p> <ul style="list-style-type: none"> <li>• Turn off the washer, unplug it, wait one minute, and then plug the washer in again. If the information code remains, contact a Samsung customer service center.</li> </ul>
dC	<p>Operating the washer with the door open.</p> <ul style="list-style-type: none"> <li>• Make sure the door is properly closed.</li> <li>• Make sure laundry is not caught in the door.</li> </ul>
HC	<p>High temperature heating check.</p> <ul style="list-style-type: none"> <li>• Turn off the washer, unplug it, wait one minute, and then plug the washer in again. If the information code remains, contact a Samsung customer service center.</li> </ul>
LC	<p>Check the drain hose.</p> <ul style="list-style-type: none"> <li>• Make sure the end of the drain hose is positioned correctly.</li> <li>• Make sure the drain hose is not clogged.</li> </ul>

	<ul style="list-style-type: none"> <li>• Turn off the washer, unplug it, wait one minute, and then plug the washer in again. If the information code remains, contact a Samsung customer service center.</li> </ul> <p><b>NOTE</b> When the washer displays “LC”, the washer do draining for 3 minutes. During this time, the Power button is inoperative.</p>
OC	<p>Water overflowed.</p> <ul style="list-style-type: none"> <li>• Restart after spinning.</li> <li>• Turn off the washer, unplug it, wait one minute, and then plug the washer in again. If the information code remains, contact a Samsung customer service center.</li> </ul>
PC	<p>When position of the clutch can't be detected.</p> <ul style="list-style-type: none"> <li>• Turn off the washer, unplug it, wait one minute, and then plug the washer in again. If the information code remains, contact a Samsung customer service center.</li> </ul>
PC1	<p>After position of the clutch is detected, if the signal from the hall clutch hall is incorrect.</p> <ul style="list-style-type: none"> <li>• Turn off the washer, unplug it, wait one minute, and then plug the washer in again. If the information code remains, contact a Samsung customer service center.</li> </ul>
Ub	<p>Spinning does not work.</p> <ul style="list-style-type: none"> <li>• Make sure laundry is spread out evenly.</li> <li>• Make sure the washing machine is on a flat, stable surface.</li> <li>• Redistribute the load. If only one item of clothing needs washing, such as a bathrobe or pair of jeans, the final spin result might be unsatisfactory, and an “Ub” check message will appear in the display.</li> </ul>
Ur	<p>Display for additional rinsing.</p> <ul style="list-style-type: none"> <li>• Show additional rinsing in sensing unbalance.</li> <li>• Method of releasing the display.</li> <li>• Any key input.</li> </ul>

**Warning**



This content is compiled from multiple sources and is provided for reference purposes only. It may not be complete or fully applicable to all situations. If you are unable to resolve your issue, please contact the product manufacturer or an authorized service provider for official support.

---

Document generated by [ManualsFile](#)

