

Operation Instruction

About the dishwasher control panel.

You can locate your model number on the tub wall just inside the door. Throughout this manual, features and appearance may vary from your model.

Front-Control Dishwashers

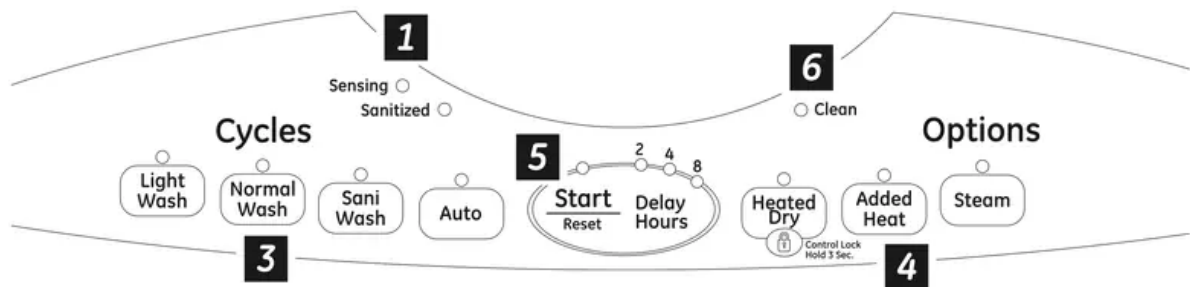

Top-Control Dishwasher

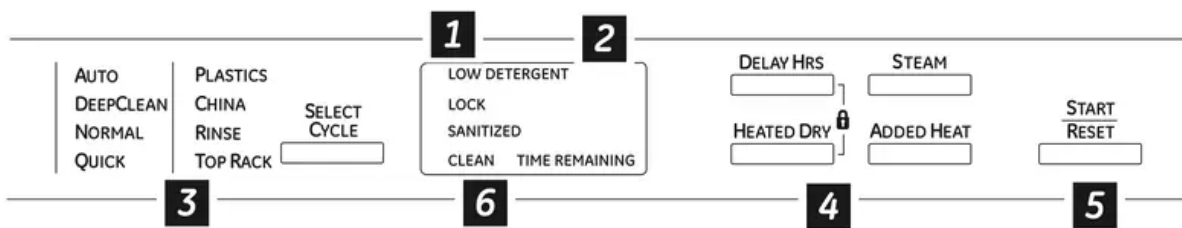

Control Settings

1. Status Indicator Lights (Indicators vary by models)

The Status display tells you what is happening while the dishwasher is in operation and may flash, indicating a malfunction. The lights will come ON indicating the sequence of



the dishwasher operation.

| | |
|-------------------------------|--|
| LOW DETERGENT | Displayed when the SmartDispense™ needs to be refilled with liquid or gel automatic dishwasher detergent. NOTE: If you are not using SmartDispense™ and you want to turn the LOW DETERGENT LED light off, press the ADDED HEAT button 5 times within 3 seconds. You will hear 3 beeps; then the light will go off. You can turn the light back on by pressing the ADDED HEAT button 5 times within 3 seconds. |
| SENSING | Displayed while the Clean Sensor™ is measuring the amount of soil and temperature of water. The dishwasher will adjust the selected cycle to achieve optimal performance. |
| SANITIZED | Displayed at the end of the cycle when SANITIZE has been selected and the dishwasher has met the requirements for sanitization. See SANITIZE, below, for complete cycle description. Opening the door or pressing any key while the door is closed and latched will turn off the light. |
| CLEAN | Displayed when a wash cycle is complete. Refer to Item 6, page 9, for further explanation of clean light operation |
| CYCLE STATUS INDICATOR | The cycle status indicator light is located on the right side of the dishwasher, above the handle. This light comes on as amber while the selected cycle is running. The light turns to green when the selected cycle is complete. The light stays ON as green as a reminder that the dishes are clean until the door is opened or until another cycle is selected. |

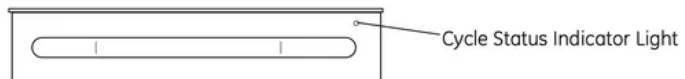

2. Time Remaining Display (on some models)

During operation, the display shows the minutes remaining until the cycle is complete. The display may adjust the remaining time while the Sensing light is on. The time displayed at the start of each cycle may change from the factory setting as the unit customizes itself to home use. During a delay start, the display will show hours of time remaining until the cycle starts.

NOTE: This dishwasher is equipped with CleanSensor™ with automatic temperature control; therefore, cycle length and time may vary depending on soil and water temperature conditions.

3. Wash Programs (Selections)

Front-Control Dishwashers: Close and latch door. Press the button for the desired wash cycle. Top-Control Dishwashers: Use the Select Cycle button to scroll through the wash cycles while the door is open.

NOTE: All cycle times and water usage information contained in the following section are approximate values. Actual results will depend on several factors, including but not limited to inlet temperature and amount of soil in the wash water.

The light above or next to the selected button will be ON to indicate which WASH CYCLE has been selected.

| Wash Program | Time (minutes) | Water Usage (gallons/cycle) | Food Soil Level | Description |
|---------------------------------|----------------|-----------------------------|------------------------|---|
| Sanitize/ Sani Wash | 50-135 | 7.5-8.75 | Light to heavy | This cycle raises the water temperature in the final rinse to sanitize your dishware. NOTE: This cycle is monitored for sanitization requirements. If the cycle is interrupted during or after the main wash portion or if the incoming water temperature is so low that adequate water heating cannot be achieved, the sanitizing conditions may not be met. In these cases, the sanitized light will not illuminate at the end of the cycle. When using this cycle, do not open the dishwasher door in the final rinse. |
| Deep Clean/ Scour | 115-175 | 10 | Heavy to baked on food | This cycle is meant for heavily soiled dishes or cookware with dried on or baked on soils. Every day dishes are safe to be used in this cycle. NOTE: On some models the STEAM enhancement will be automatically selected when this cycle is selected, and cannot be deselected. NOTE: This cycle is monitored for sanitization requirements. If the cycle is interrupted during or after the main wash portion or if the incoming water temperature is so low that adequate water heating cannot be achieved, the sanitizing conditions may not be met. In these cases, the sanitized light will not illuminate at the end of the cycle. When using this cycle, do not open the dishwasher door in the final rinse. |
| Cookware/ Pots & Pans | 75-140 | 8.75-10 | Heavy to baked on food | This cycle is meant for heavily soiled dishes or cookware with dried on or baked on soils. Everyday dishes are safe to be used in this cycle. |
| Auto | 62-114 | 5.2 | Light to heavy | This cycle is meant for light to heavily soiled dishes. |
| Normal | 68-118 | 3.75-5.2 | Normally soiled dishes | This cycle is meant for normal every day soil levels and is designed to conserve both water and energy. The Normal cycle was used to rate the efficiency of this dishwasher. |
| China/ Crystal Light Wash | 40-60 | 7.5 | Light to Normal | This cycle is specifically designed for delicate ware such as crystal and china by maintaining lower temperatures. |
| Glasses | 40-75 | 7.5 | Light to normal | This cycle is specifically designed for glasses. |
| Plastics | 85-145 | 6.25-7.5 | Light to heavy | This cycle is specifically designed for plastic ware and includes a built in drying portion that is specifically designed to reduce the risk of melting plastic items and improve plastic drying. |
| Top Rack | 50-110 | 5-8.75 | Light | Upper rack only. |
| Rinse | 11 | 2.5 | Any | For rinsing partial loads that will be washed later. Do not use detergent with this cycle. |

NOTE: Only the Sanitize, Sani Wash, Deep Clean and Scour cycles have been designed to meet the requirements of Section 6, NSF 184 for soil removal and sanitization efficacy.

NOTE: NSF-certified residential dishwashers are not intended for licensed food establishments.

4. Enhancements

The light above the selected button will be on to indicate which **ENHANCEMENT** has

been selected.

| ENHANCEMENTS | DESCRIPTION |
|--|--|
| DELAY HOURS | <p>You can delay the start of a wash cycle for up to 24 hours (depending on model). Press the DELAY START button to choose the number of hours you want to delay the start of the cycle; then press START/RESET.</p> <p>Front-Control Dishwashers: The machine will count down and start automatically at the correct time.</p> <p>Top-Control Dishwashers: After closing the door, the machine will count down and automatically start at the correct time.</p> <p>NOTE: To cancel the DELAY START selection before the cycle begins, repeatedly press the DELAY START button until the display is blank.</p> |
| ADDED HEAT | <p>When selected, the cycle will run longer with heating element on to improve both wash and dry performance.</p> <p>NOTE: Cannot be selected with RINSE AND HOLD cycle.</p> |
| STEAM | <p>For use with heavily soiled and/or dried-on, baked-on soils. This option MUST be selected PRIOR to starting the cycle. The STEAM option adds 26 minutes to the cycle time.</p> <p>NOTE: Cannot be selected with RINSE AND HOLD cycle.</p> |
| HEATED DRY | <p>When HEATED DRY is off, dishes will air dry. Top-control models have a fan that assists the drying process.</p> <p>Light Off: Shuts off the drying heat option. Dishes will air dry naturally (front-control dishwashers) or fan dry (top-control dishwashers) to save energy.</p> <p>Light On: Turns the heater on for faster drying. This will extend the total cycle time between 8 and 38 minutes depending on the cycle selected.</p> <p>NOTE: Cannot be selected with RINSE AND HOLD cycle.</p> |
| LOCK  | <p>You can lock the controls to prevent any selections from being made. Or you can lock the controls after you have started a cycle.</p> <p>Children cannot accidentally start dishwasher by touching buttons with this option selected.</p> <p>Front Control: To unlock the dishwasher controls, press and hold the HEATED DRY button for 3 seconds. The light above the lock button will turn off. To lock the dishwasher, press and hold the HEATED DRY button for 3 seconds. The light above the LOCK button will turn on.</p> <p>Top Control: To unlock the dishwasher controls, press and hold the HEATED DRY and DELAY HOURS buttons for 3 seconds. The lock status indicator light will turn off. To lock the dishwasher, press and hold the HEATED DRY and DELAY HOURS buttons for 3 seconds. The lock status indicator light will turn on.</p> |
| START/RESET | <p>For top control models, open the door slowly. For front control models leave the door closed, then follow below.</p> <p>To change a cycle after washing starts, touch the START/RESET button to cancel the cycle.</p> <p>The START/RESET LED will turn off and the drain pump will pump water out of the dishwasher for 75 seconds and then turn off. Cycle selection and option LED's will remain on, and buttons will respond during pump out. If the START/RESET is pressed while the dishwasher is in pump out, the START/RESET LED will turn on and the dishwasher will start a new wash cycle.</p> |

5. Start

Front-Control Dishwashers

Close and latch the dishwasher door and select the cycle and desired enhancements.

Touch the **START/RESET** button one time to begin the cycle. Water fill begins immediately, and approximately 60 seconds later the wash action begins.

When the dishwasher door is fully closed and latched, the control panel lights will display the last settings you selected. If you don't want to change any of the settings, simply touch the **START/RESET** button to begin the cycle.

If the door is closed, the indicator lights will turn off if the **START/RESET** button is not selected within 5 minutes. To activate the display, open and close the door or press any

button.

Top-Control Dishwashers

After selecting the cycle and desired enhancements, touch the START/RESET button to ready the dishwasher to begin the cycle. Close the door to start the cycle or begin the DELAY START countdown. When the cycle starts, the water fill begins and approximately 60 seconds later the wash action begins.

The dishwasher will always display your last selection and enhancements. If you don't want to change the settings, simply touch the START/RESET button to ready the dishwasher and close the door to begin the cycle.

ALL MODELS: If a power failure occurs AUTO and HEATED DRY will automatically be programmed. Make any new selections and touch the START/RESET button to begin the new cycle.

When the door is opened, the indicator lights will turn off if the START/RESET button is not selected within 5 minutes. To activate the display, open and close the door or touch any button.

6. Clean

Front-Control Dishwasher

The CLEAN light will illuminate and a double beep will sound when a wash cycle is complete. On some models, the CLEAN light will turn off when the door is opened. On other models, the CLEAN light will remain on until the door is opened and then relatched or until any keypad is pressed while the door is latched shut.

Top-Control Dishwasher

The CLEAN light will illuminate and a double beep will sound when a wash cycle is complete. The CLEAN light will remain on until the door is opened and then relatched or until any key is pressed.

ALL MODELS: To turn off the audible end-of-cycle signal (or re-activate it if it was previously turned off), press the HEATED DRY button 5 times within 3 seconds. A triple beep will sound to indicate the end-of-cycle beep option has been toggled.

Recommended dishwasher products.

GE recommends the following products for use in its dishwashers:

- For your manual detergent dispenser, Cascade® Complete ActionPacs are recommended. Powders, liquids, and gels may also be used but may not work as effectively. See page 11 for more details.
- For your SmartDispense™ Detergent Dispenser, Cascade® Complete gel is recommended. See page 12 for differences between liquid gel types and a warning about mixing liquid detergents together.

- Cascade® Rinse Aid™ rinse agent to remove spots and prevent new film buildup on your dishes, glasses, flatware, cookware and plastic. Using rinse agent also improves dry performance.

Using the Dishwasher

Check the Water Temperature

The entering water should be at least 120°F and not more than 150°F for effective cleaning and to prevent dish damage. Check the water temperature with a candy or meat thermometer. Turn on the hot water faucet nearest the dishwasher, place the thermometer in a glass and let the water run continuously into the glass until the temperature stops rising.

Use Cascade® Rinse Aid™ Rinse Agent

Cascade® Rinse Aid™ rinse agent improves drying, removes spots and prevents new film buildup on your dishes, glasses, flatware, cookware and plastic.

Filling the Dispenser

The rinse agent dispenser holds 3.5 oz. of rinse agent. Under normal conditions, this will last approximately one month. Try to keep it full, but do not overfill.

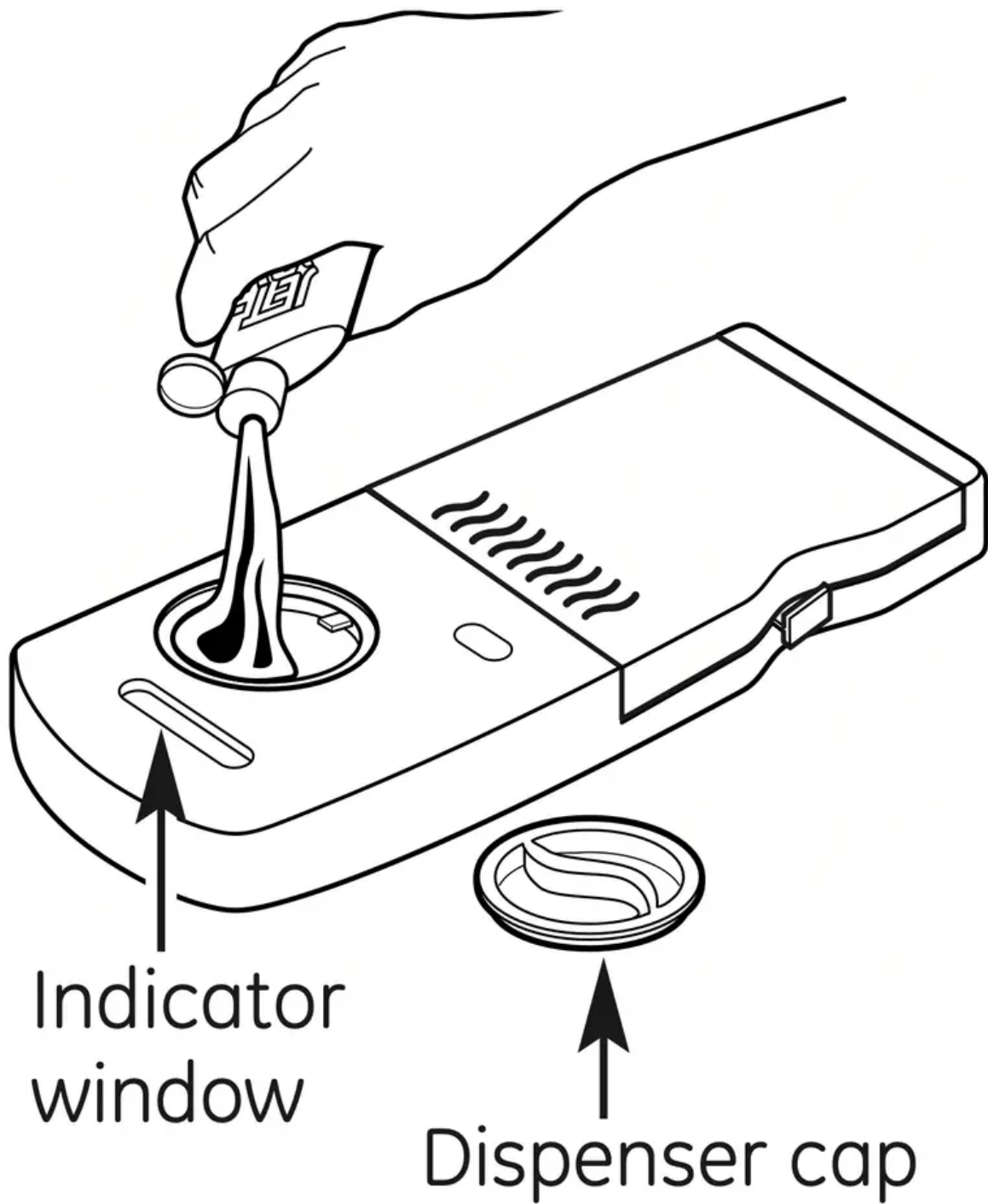

1. Make sure the dishwasher door is fully open.
2. Turn the dispenser cap to the left and lift it out.
3. Add rinse agent until the indicator window is full.
4. Clean up any spilled rinse agent with a damp cloth.
5. Replace the dispenser cap.

Rinse Aid Setting

The amount of rinse agent released into the final rinse can be adjusted. The factory setting is at the midpoint. If there are rings of calcium (hard water) spots on dishes, try a higher setting. If there is foaming, use a lower setting.

To adjust the setting: Remove the dispenser cap; then turn the adjuster counter clockwise to increase the amount of rinse agent or clock wise to reduce the amount of rinse agent dispensed.

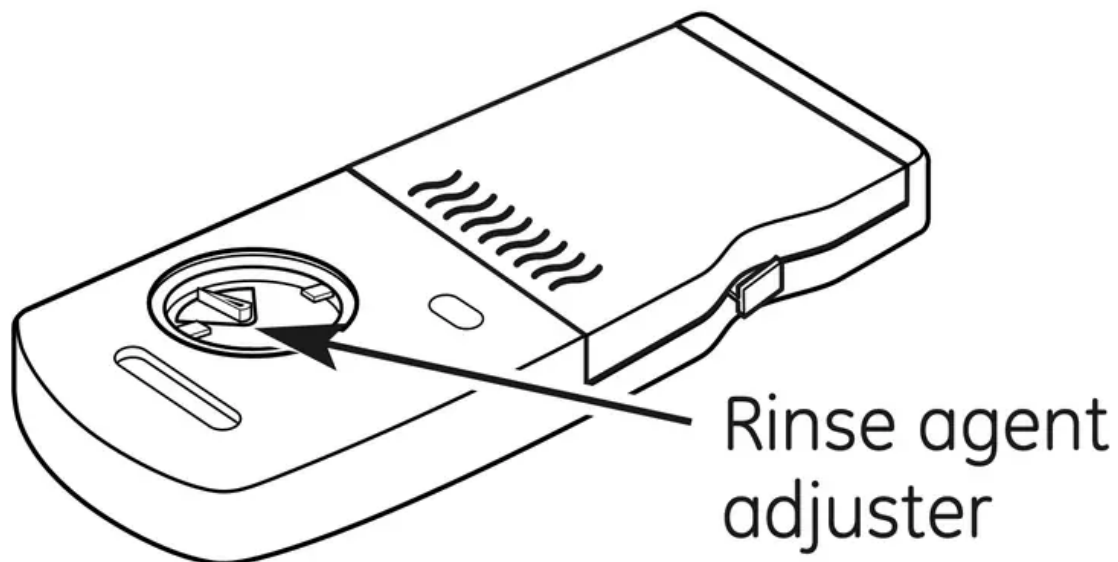

Dish Preparation Prior to Loading

- No prerinsing of normal food soil is required.
- Remove large quantities of any remaining food.
- Scrape off hard soils, bones, tooth picks, skins and seeds.
- Remove leafy vegetables, meat trimmings and excessive amounts of grease or oil.

Forget to Add a Dish?

A forgotten dish can be added any time, however, for best wash performance it is recommended to add a dish prior to the opening of the detergent cup.

1. Squeeze the door latch to release the door.
2. Do not open the door until the water spray action stops. Steam may rise out of the dishwasher.
3. Add forgotten dishes.
4. Close the door and dishwasher will start in 5 seconds.

Detergent Dispenser

The detergent dispenser is on the upper left hand side of the dishwasher door. It has two compartments. Use the main wash compartment for all loads. Use the pre-wash compartment only when your water is extremely hard or when you have a heavy soiled load.

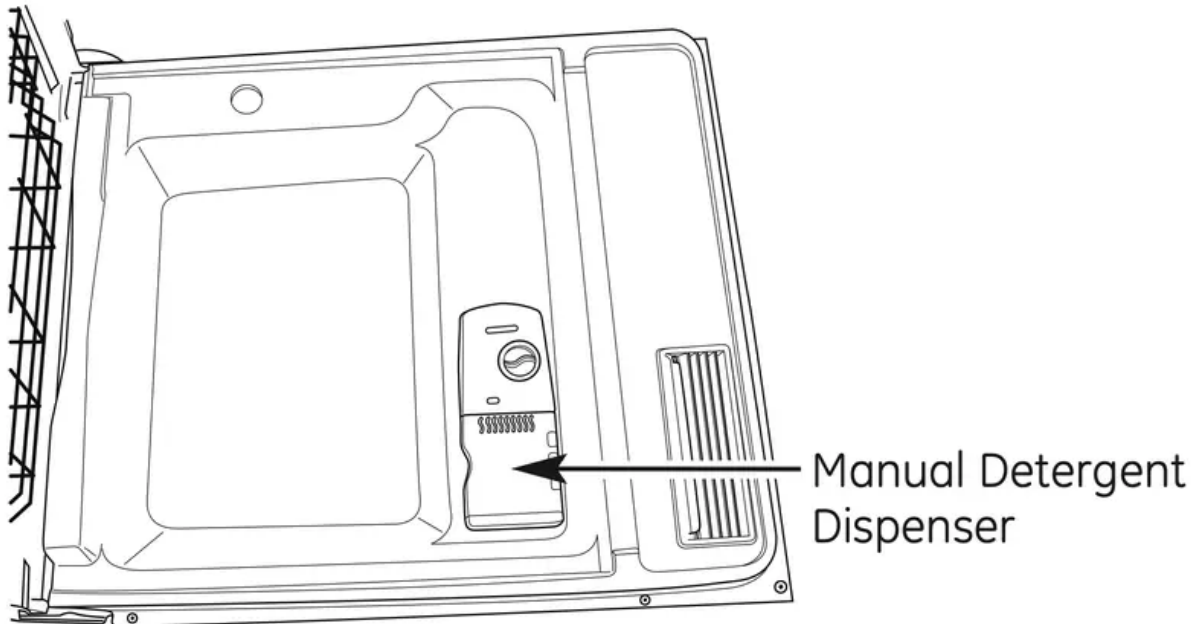

You may use tablet, powder, liquid or gel automatic dishwasher detergent. Make sure you use only detergents specifically labeled for use in automatic dishwashers. Never use liquid hand dish detergent in an automatic dishwasher. Sudsing and poor wash performance will result with the use of improper detergents.

Detergents should be stored in a dry location and in their original container to prevent loss of effectiveness. Place detergent in the cup just prior to starting the dishwasher and then close and latch the cover. The cover will open during the wash cycle.

Filling the Detergent Dispenser

GE recommends using detergent in tablet or packet form. Independent testing has shown this form of detergent is very effective in the dishwasher. Cascade® Complete Action Packs are an example of this type of detergent. Simply put a tablet or packet into the main wash compartment and then close and latch the detergent cup cover. Please notice that the tablet or packet must be placed in the main wash compartment of the detergent cup. If the tablet or packet is tossed in the bottom of the dishwasher, the detergent will be flushed down the drain in a very short period of time and will thus be wasted. Wash performance will be very poor as a result.

If you choose to use detergent in powder, liquid or gel form, the amount of detergent you use will be determined by the hardness of your water, the temperature of your water, and the food soil load inside the dishwasher. Contact your water company to get information about the hardness of the water in your area. Alternatively, you may purchase a hard water test strip from GE. Call 1-800-626-2002 and ask for part number WD01X10295.

| <i>Number of Grains</i> | <i>Detergent Cups to Fill</i> |
|--------------------------------|--|
| Less than 4 | Fill cup to soft line (1/3 full) |
| 4 to 8 | Fill cup to medium soft line (2/3 full) |
| 8 to 12 | Fill cup to medium hard line (completely full) |
| Greater than 12 | Fill both main wash cup and pre wash cup |

Using too much detergent with very soft and/or very hot water may cause a condition called etching on your glassware. Etching is a permanent cloudiness in your glassware. This condition is irreversible. However, using too little detergent will cause poor wash performance.

Use the table as a starting point and then adjust the amount of detergent you use. Use just enough to get good wash performance. Using just the right amount of detergent will provide great wash performance without wasting detergent or etching of glassware.

DO NOT USE HAND DISH DETERGENT

NOTE: Using a detergent that is not specifically designed for dishwashers will cause the dishwasher to fill with suds. During operation, these suds will spill out of the dishwasher vents, covering the kitchen floor and making the floor wet.

Because so many detergent containers look alike, store the dishwasher detergent in a separate space from all other cleaners. Show anyone who may use the dishwasher the correct detergent and where it is stored.

While there will be no lasting damage to the dishwasher, your dishes will not get clean using a dishwashing detergent that is not formulated to work with automatic dishwashers.



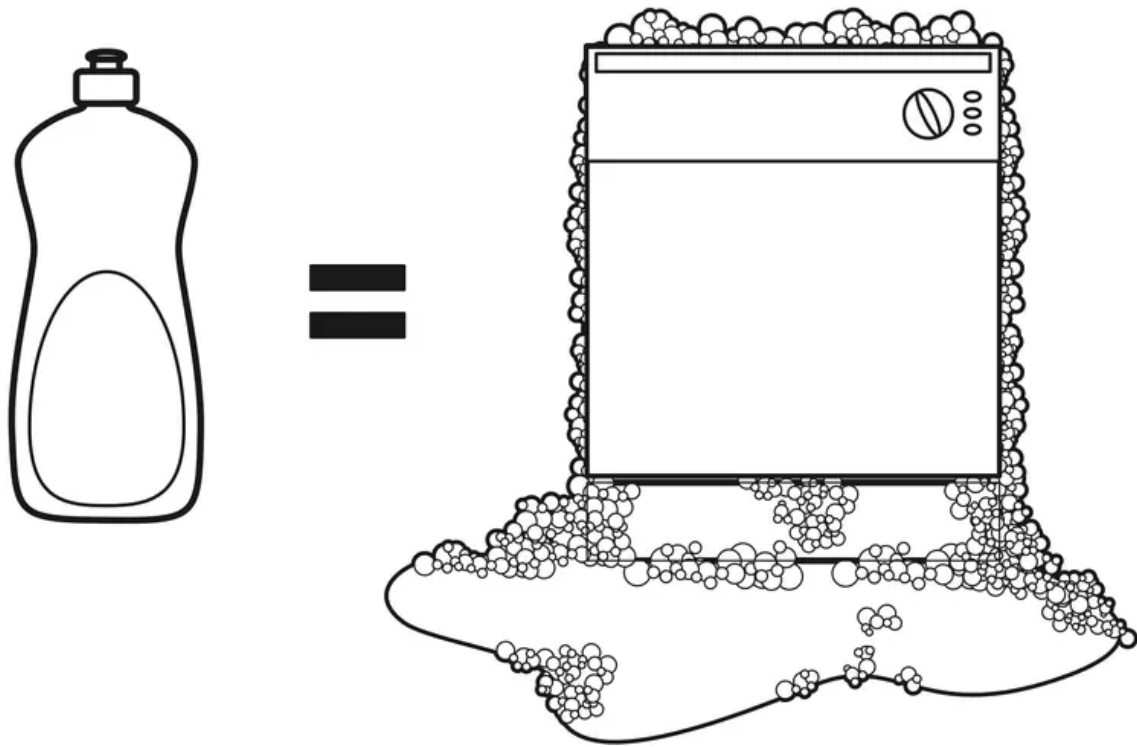

SmartDispense™ Detergent Dispenser (some models)

This dishwasher may have SmartDispense™, a feature which automatically dispenses liquid automatic dishwasher detergent into each cycle based on soil level and water hardness. To utilize the SmartDispense™ Detergent Dispenser, it must first be filled. Although any liquid or gel automatic dishwashing detergent can be used in the SmartDispense™ system, all liquid or gel automatic dishwashing detergents are not the same. Most automatic dishwashing detergents are chlorine bleach-based (such as Cascade®) while others contain enzymes (such as Cascade Complete®).

Do not mix any chlorine bleach-based automatic dishwashing detergent with any dishwashing detergent containing enzymes as this could cause the detergents to congeal and lead to blockage of the SmartDispense™ system.

Check the detergent label to determine if the detergent is chlorine bleach-based or one that contains enzymes. It is recommended that the same type of detergent be used when refilling your SmartDispense™ system.

CAUTION! Absolutely do not add powder detergent, tablets or any liquid soap or detergent normally used for washing hands or dishes in a sink. Only use liquid or gel detergent specifically designed for use in an automatic dishwasher.

To open the dispenser for filling, push down and turn the blue cap counter clockwise until the cap is loose. Lift cap off.

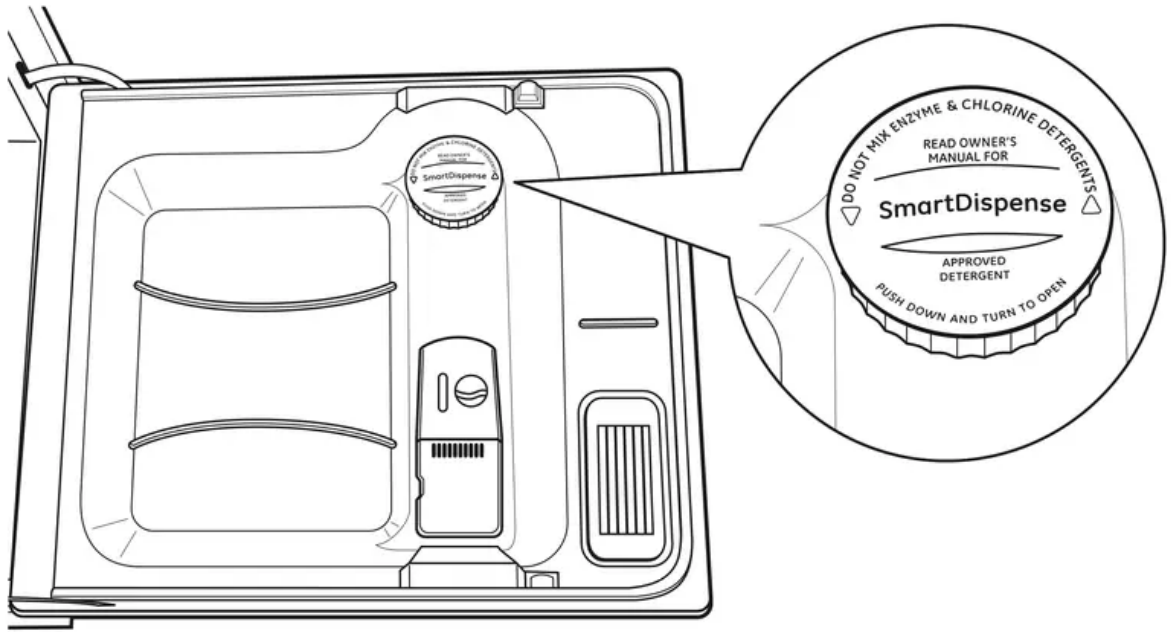

Set the door at a comfortable angle to fill the dispenser.

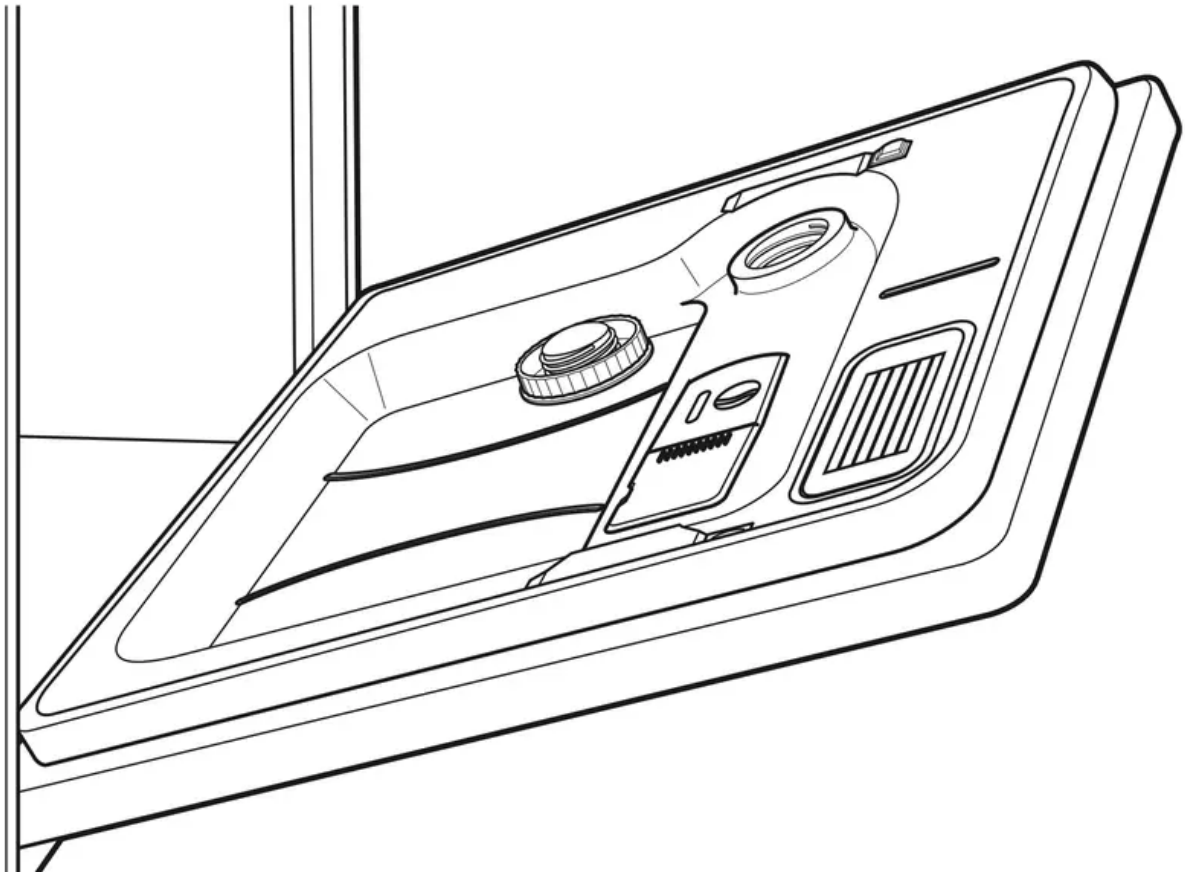

Aim the detergent bottle at the opening in the door and begin to fill.

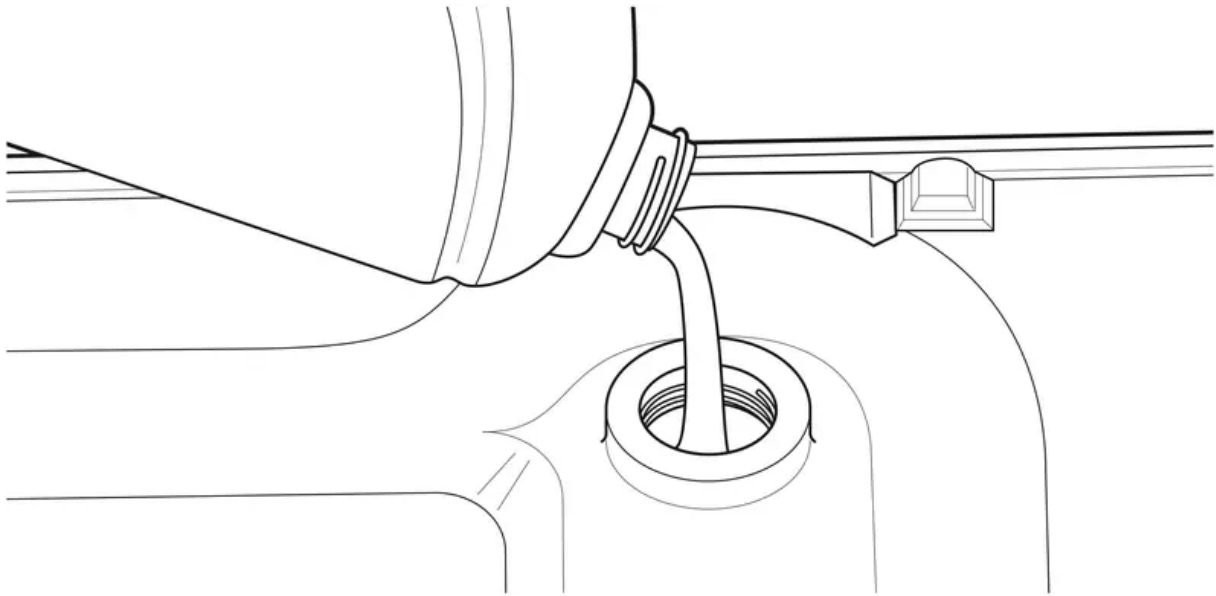

The dispenser will hold 45 oz of liquid dishwasher detergent (standard size bottle).



When full, replace the cap and turn clockwise until tight to ensure no water enters the SmartDispenseTM dispenser. If residue is left on the door, it will be washed off in the next cycle.

An indicator light will turn on to notify you when the dispenser needs to be filled again. After filling, the light will not turn off until the door is closed. A full dispenser will last approximately 1 month for the average user.

STATUS

SmartDispense

Light Will Turn On When Time to Refill → ○ **LOW DETERGENT** ● **DRYING**
 ● **SENSING** ● **SANITIZED**
 ● **WASHING** ● **CLEAN**

(appearance may vary)

NOTE: If you are not using SmartDispense™ and you want to turn the LOW DETERGENT LED light off, press the ADDED HEAT button 5 times within 3 seconds. You will hear 3 beeps; then the light will go off. You can turn the light back on by pressing the ADDED HEAT button 5 times within 3 seconds.

SmartDispense™ Detergent Dispenser Water Hardness Calibration

Prior to the first use, the dishwasher needs to be calibrated for water hardness. Please follow the directions below to calibrate the dishwasher to the hardness of your tap water.

Determine the Hardness of Your Tap Water

In the bag that contained these instructions, you should find a water hardness test strip package. Read the instructions on the package, remove the test strip and follow the instructions to determine the hardness level of your tap water. You will use this information to calibrate your dishwasher to dispense the optimal amount of detergent.

Calibration of Front-Control Models With 3-Digit Display

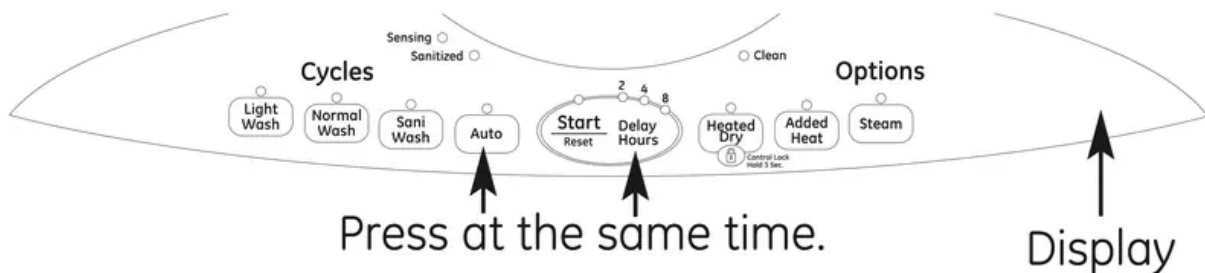

1. Close and latch the door (lights on, dishwasher not running).
2. Press the AUTO and DELAY HOURS buttons at the same time for 3 seconds.
3. The display will show a number from 1 to 5. This is the water hardness value currently set.
4. Press the AUTO button to raise the value or the NORMAL button to lower the value. Set the water hardness value to the number determined with the test strip and table above.

- Once the water hardness is set, press the START/RESET button to save the setting and return the dishwasher to normal operation.

Calibration of Front-Control Models Without a 3-Digit Display

- Close and latch the door (lights on, dishwasher not running).
- Press the AUTO button and DELAY HOURS buttons at the same time for 3 seconds. All lights will light up and you will hear 1 to 5 beeps. The number of beeps indicates the current hardness value.
- To change the setting, press the DELAY HOURS button the number of times that corresponds to the water hardness value determined at the left. The control will beep each time you press the button.
- Once finished pressing the button, you will hear a confirmation with beeps for the hardness value selected.
- If the number of beeps is not what you desire, start pressing the DELAY HOURS button again to reenter a new water hardness level.
- Once the water hardness is set, press the START/RESET button to save the setting and return the dishwasher to normal operation.

Water hardness test strip indication.

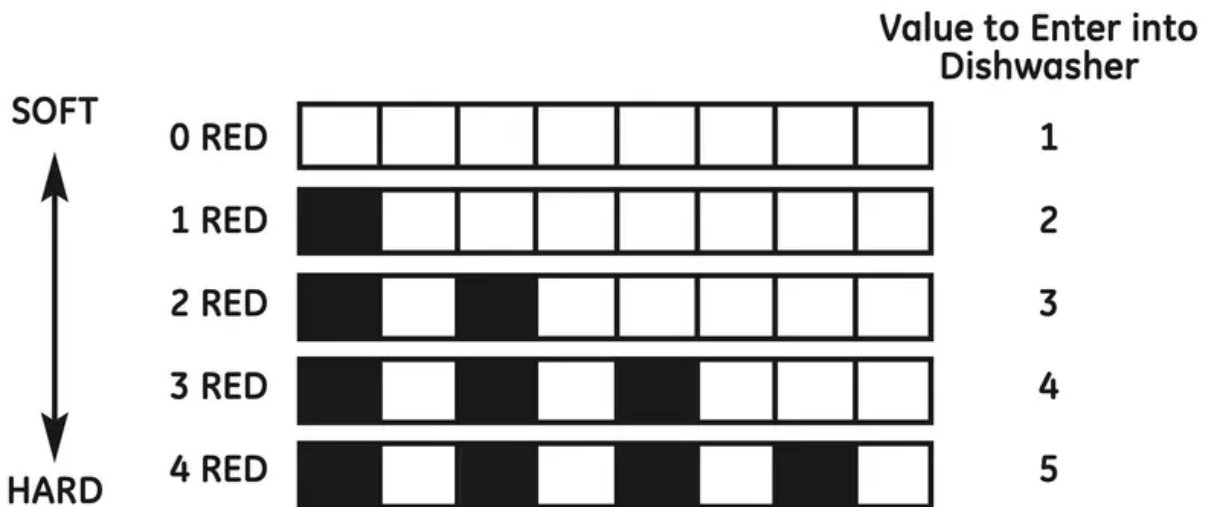

Calibration of Top-Control Models With 3-Digit Display



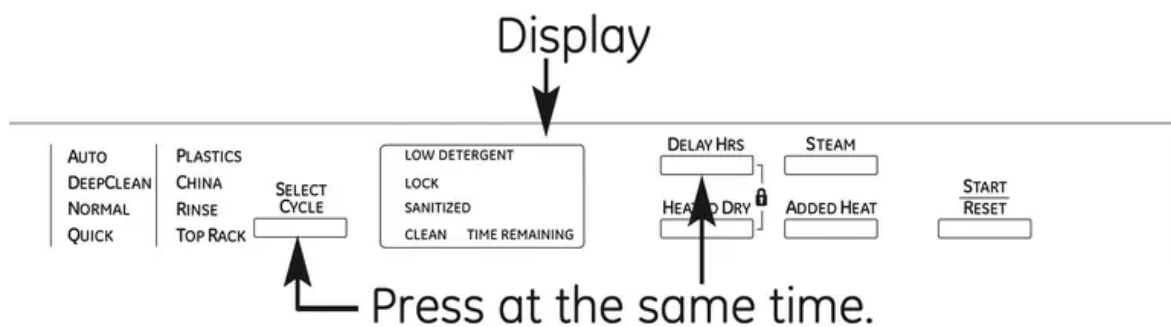

1. Open the door and touch any button other than START to turn lights on.
2. Press the Select Cycle button and DELAY HOURS button at the same time for 3 seconds. The display will show a number from 1 to 5. This is the water hardness value currently set.
3. Press the STEAM button to raise the value or the Select Cycle button to lower the value. Set the water hardness value to the number determined with the test strip and table at the left.
4. Once the water hardness is set, press the START/RESET button to save the setting and return the dishwasher to normal operation.

Calibration of-Top-Control Models Without a 3-Digit Display

1. Open the door and touch any button other than START to turn lights on.
2. Press the Select Cycle button and DELAY HOURS button at the same time for 3 seconds. All lights will light up and you will hear 1 to 5 beeps. The number of beeps indicates the current hardness value.
3. To change the setting, press the DELAY HOURS button the number of times that corresponds to the water hardness value determined at the left. The control will beep each time you press the button.
4. Once finished pressing the button, you will hear a confirmation with beeps for the hardness value selected.
5. If the number of beeps is not what you desire, start pressing the DELAY HOURS button again to reenter a new water hardness level.
6. Once the water hardness is set, press the START/RESET button to save the setting and return the dishwasher to normal operation.

Note: You should recalibrate to dishwasher control if water conditions change; for example, if a water softener system is added or removed from your home.

Loading the dishwasher racks

For best dishwashing results, follow these loading guidelines. Features and appearance of racks and silverware baskets may vary from your models.

Upper Rack



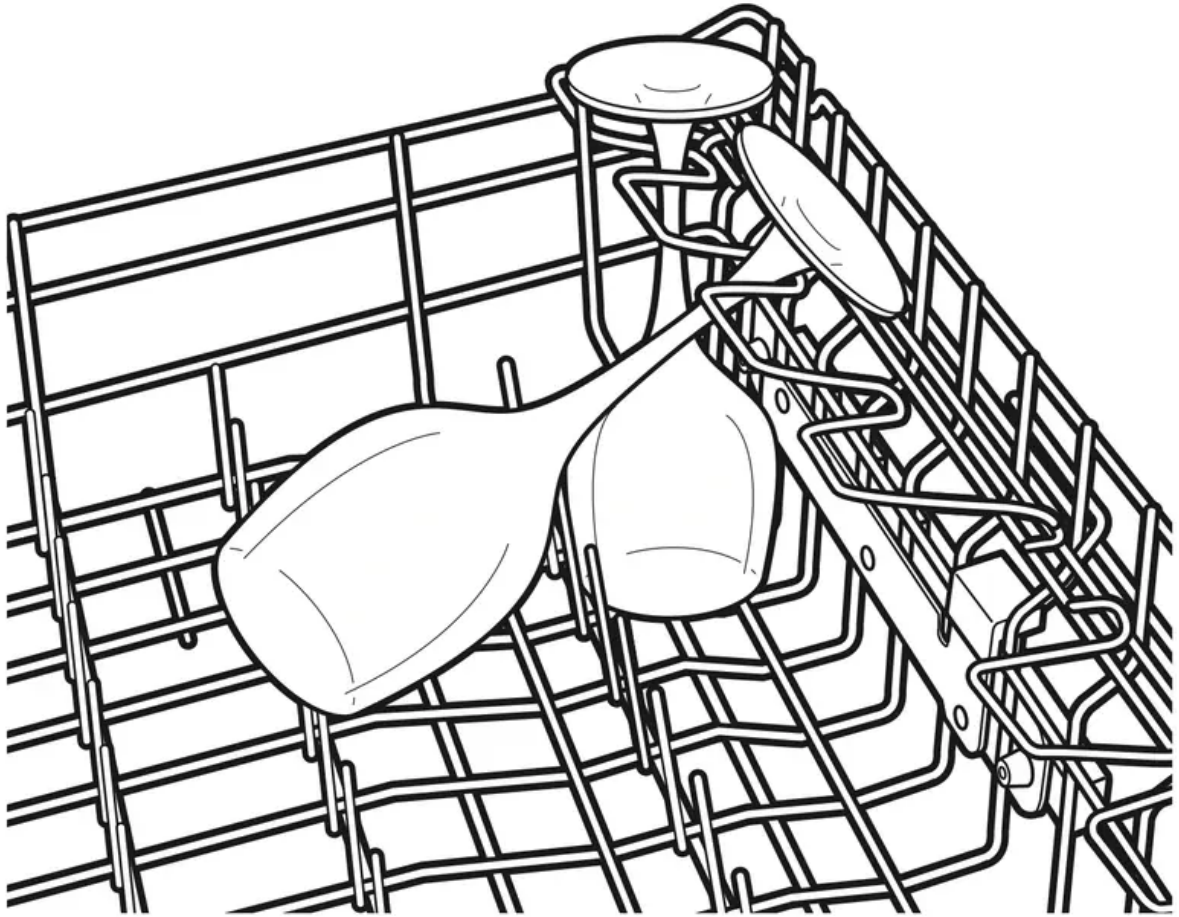

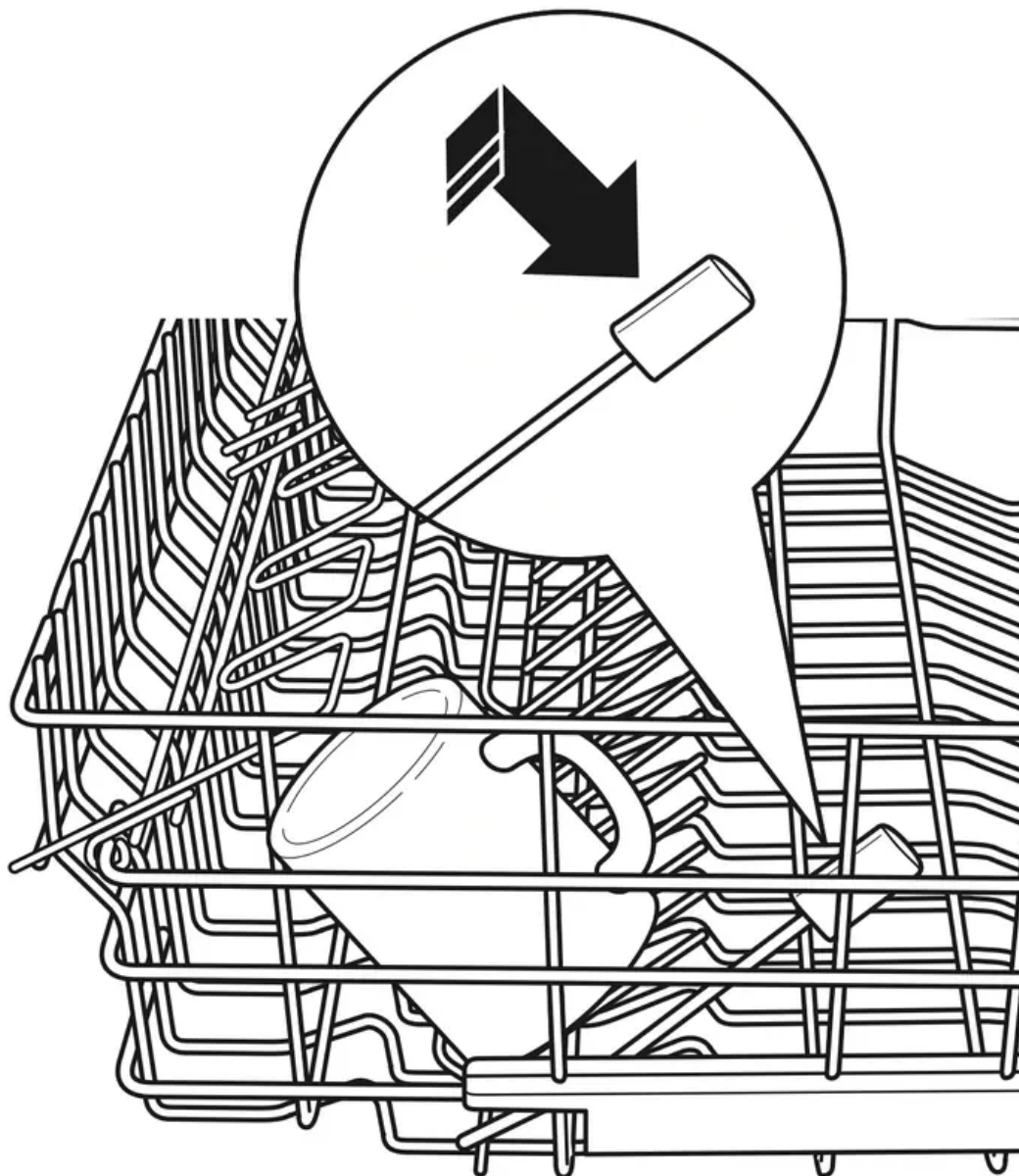

Although the upper rack is primarily for glasses, cups and saucers, pots and pans can be placed in this rack for effective cleaning. Cups and glasses fit best along the sides. This is also a secure place for dishwasher plastics.

The utility shelf (some models) may be placed in the up or down position to add flexibility. A wine glass holder (some models) secures wine glasses for best washability.

Some models have contoured metal cup shelves that can secure up to 12 wine glasses (as shown).

Because wine glasses come in various sizes, after loading, slowly push in the rack to make sure they will clear the top of the dishwasher.

Some models have an Angled Rack System, which allows you to angle your dishes, such as coffee mugs, for better cleaning and quicker drying. To position the tines, pull the lever forward then drop the tines into position, then release the lever.

The upper rack is good for all kinds of odd-shaped utensils. Saucepans, mixing bowls and other items should be placed facedown. Fold-down tines (on some models) provide flexibility for extra-large and hard-to-fit items.

Secure larger dishwasher-safe plastics over 2 tines when possible.

Make sure small plastic items are secure so they can't fall onto the heater.

Be sure that items do not protrude through the bottom of the rack and block rotation of the middle spray arm. This could result in poor wash performance for items in the upper rack.

Check to make sure that no items will block rotation of the wash arm.

NOTE: The Single Rack Wash selection, on models with this feature, washes the upper rack only. If you use this feature, do not load items in the lower rack.

Adjustable Upper Rack (on some models)

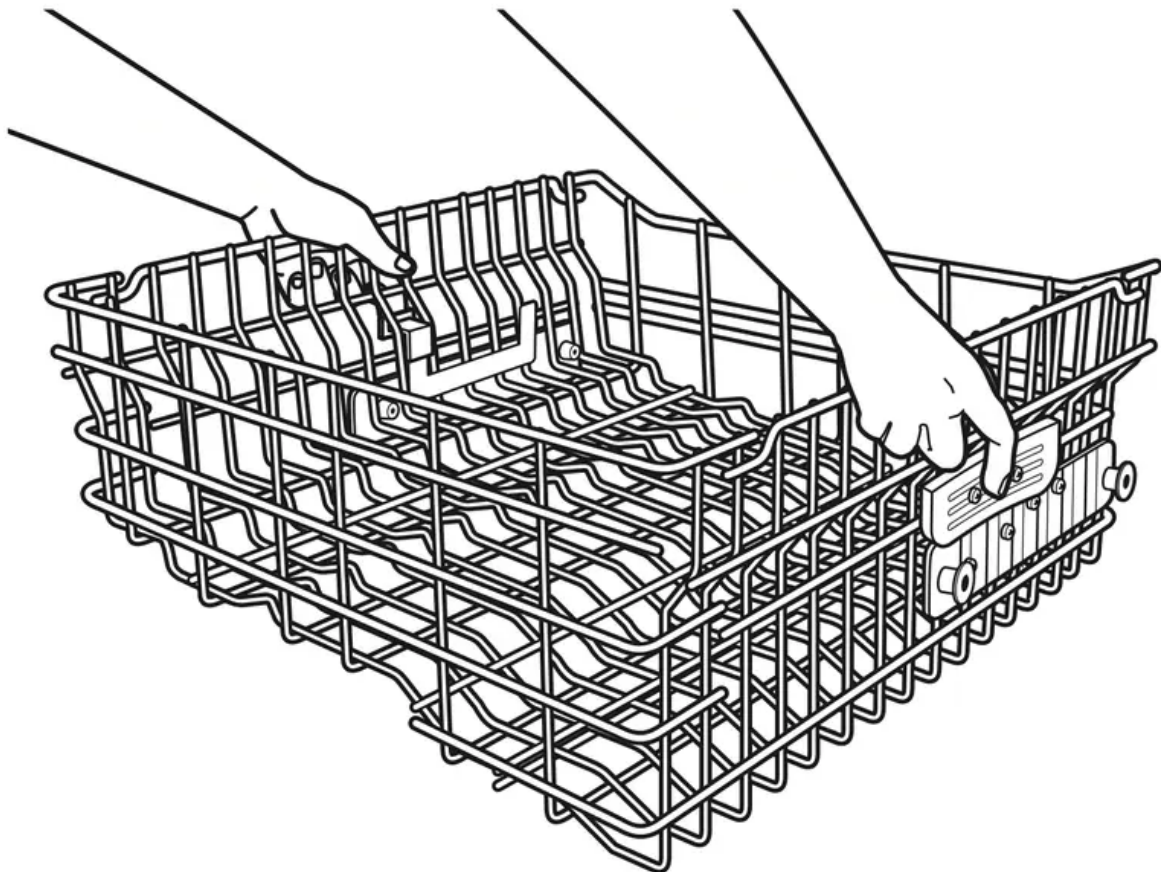



The standard position of your adjustable rack is "up" which allows for maximum clearance for your taller items in the lower rack. If you have taller wine glasses, tumblers or other items to place in the upper rack, you may want to adjust the rack to the lower position.

To lower the rack, support the weight of the rack with your hands as shown and press both finger pads about 1/4" toward the inside of the rack as indicated and guide the rack down to its lower position.

To raise the rack to the "up" position, pull upon the center of the rack side frame until the rack locks into place.

Lower Rack

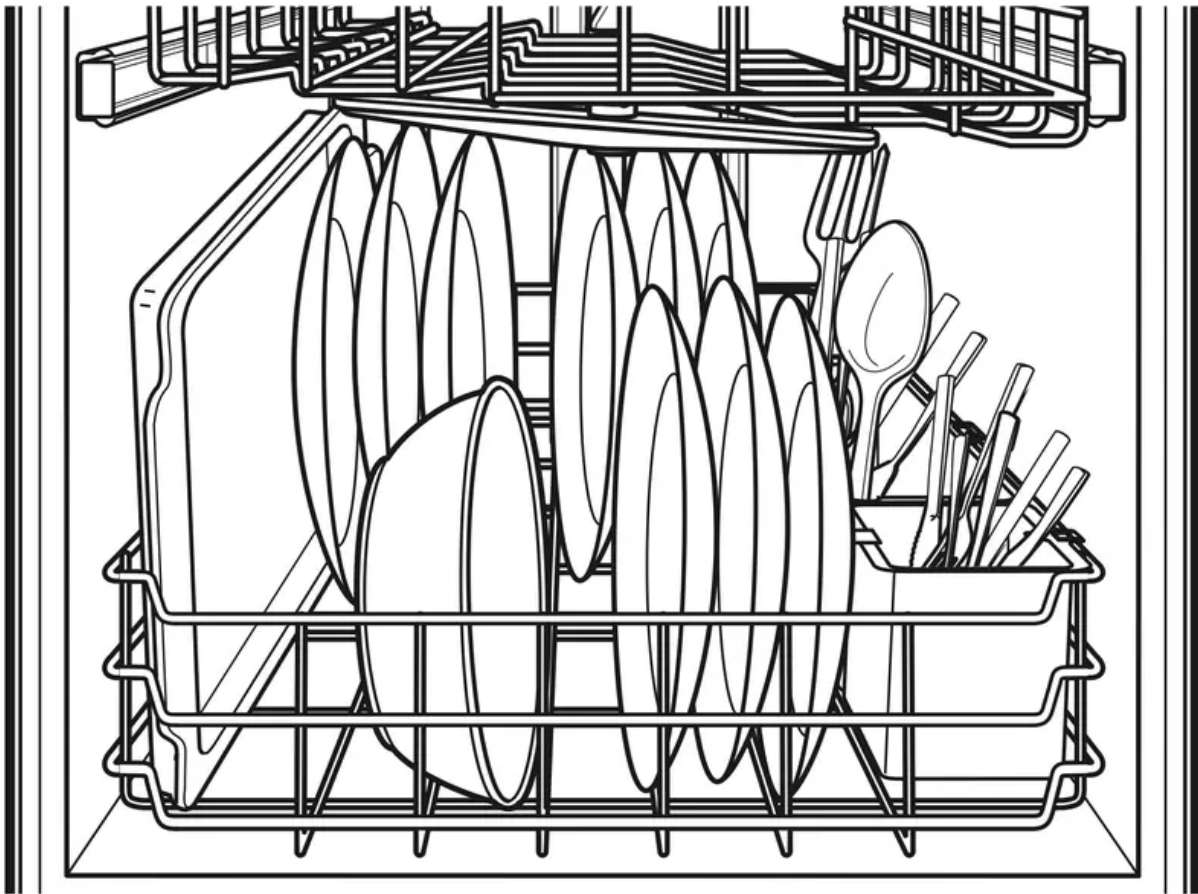

The lower rack is best used for plates, saucers and cookware. Large items such as broiler pans and baking racks should go along the left-hand side. Load platters, pots and bowls along the sides, in corners or in the back. The soiled side of items should face the center of the rack. If necessary, oversized glasses and mugs can be placed in the lower rack to maximize loading flexibility.

Also, be careful not to let a portion of an item such as a pot or dish handle extend through the bottom rack. This could block the wash arm and cause poor washing results.

Fold-down tines (on some models) provide flexibility for extra-large and hard-to-fit items. The tines may be left in the up position or folded down to customize the lower rack. Do not load large bowls or pots facedown in the front left-hand corner. Items loaded in this manner could prevent proper operation of the manual detergent cup.

Silverware Basket

To load flatware, simply push the adjustable handle to either side (on some models). Put flatware in the removable basket with fork and knife handles up to protect your hands. Place spoons in the basket with handles down. Mix knives, forks and spoons so they don't nest together. Distribute evenly. Small plastic items, such as measuring spoons and lids from small containers should go in the bottom of the silverware basket with the silverware on top.

The one-piece silverware basket (on some models) can be placed in the front, right side or back of the lower rack.

A variety of options is available regarding the three-piece silverware basket (on some models) in your dishwasher. The complete basket is designed to fit on the right side of the lower rack. Additionally, each end of the basket is removable to add loading flexibility to accommodate flatware and lower rack capacity needs.

The lids of both end and middle baskets (on some models) can be closed to contain small items. Long items can be placed on the utility shelf in the upper rack. Load flatware through the slots in the silverware basket covers.

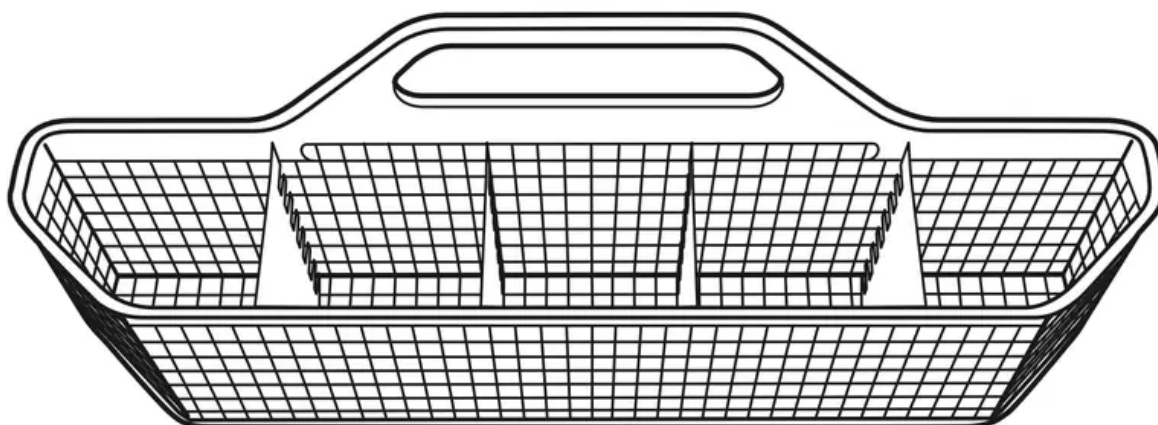

One-piece basket (on some models).

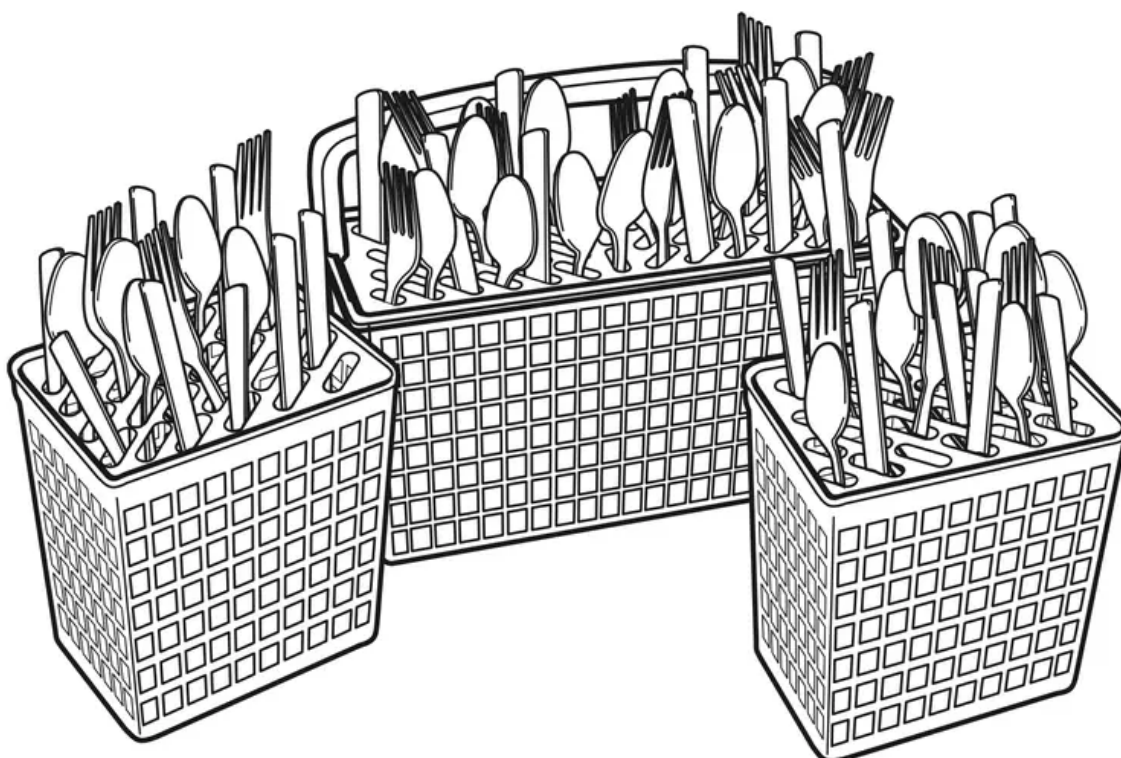

Three-piece basket (on some models).

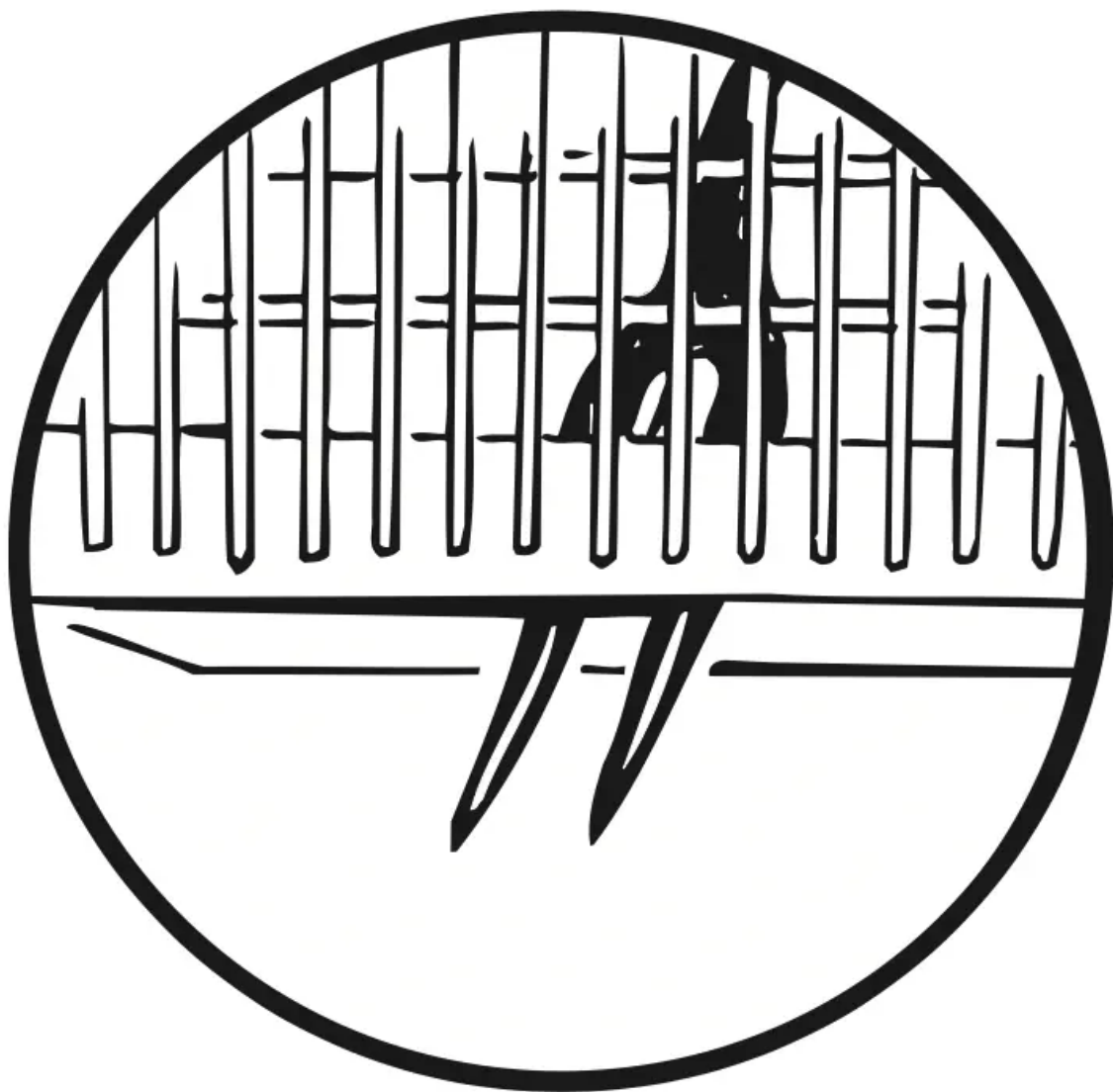

Don't let any item extend through bottom.

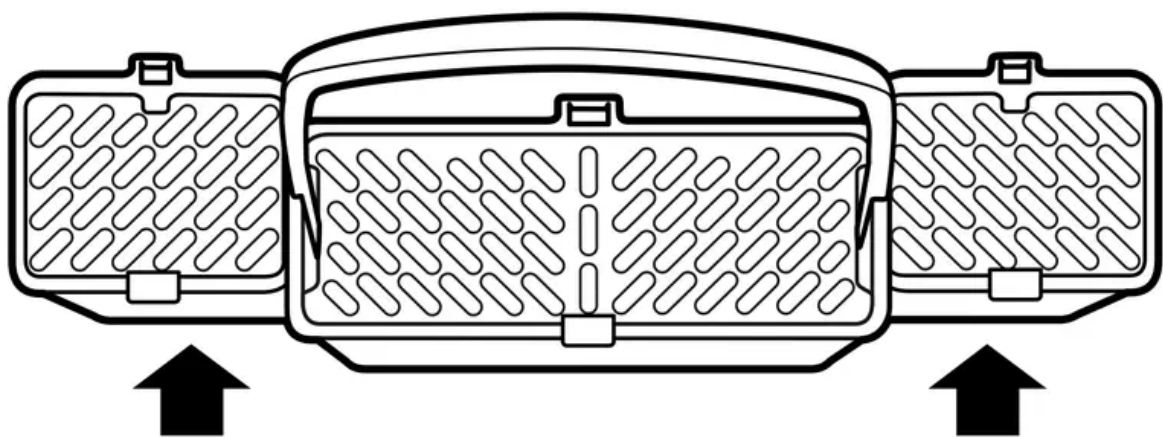

To remove end baskets, grasp the basket at opposite corners and slide apart.

Extra Rack Features (on some models)

Cutlery Tray

The cutlery tray holds up to 4 large knives such as a carver, chef's knives, bread knife, etc., that are too tall to fit in the silverware basket.

Hook the tray onto the rear of the upper rack. Lay the knives between the guides (as shown).

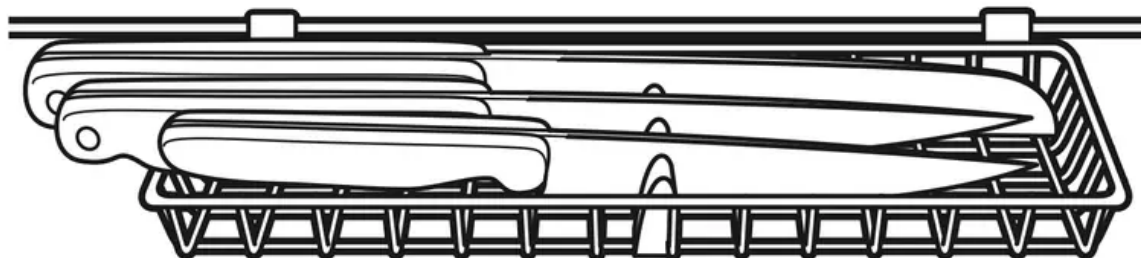

Bowl Tines

The special large-bowl tines in the lower rack add flexibility to your loading pattern. They are useful for serving bowls or other large bowls.

To use the bowl tines, fold down the 2 rows of flex tines in front of the bowl tines and load bowls just as you would in the upper rack.

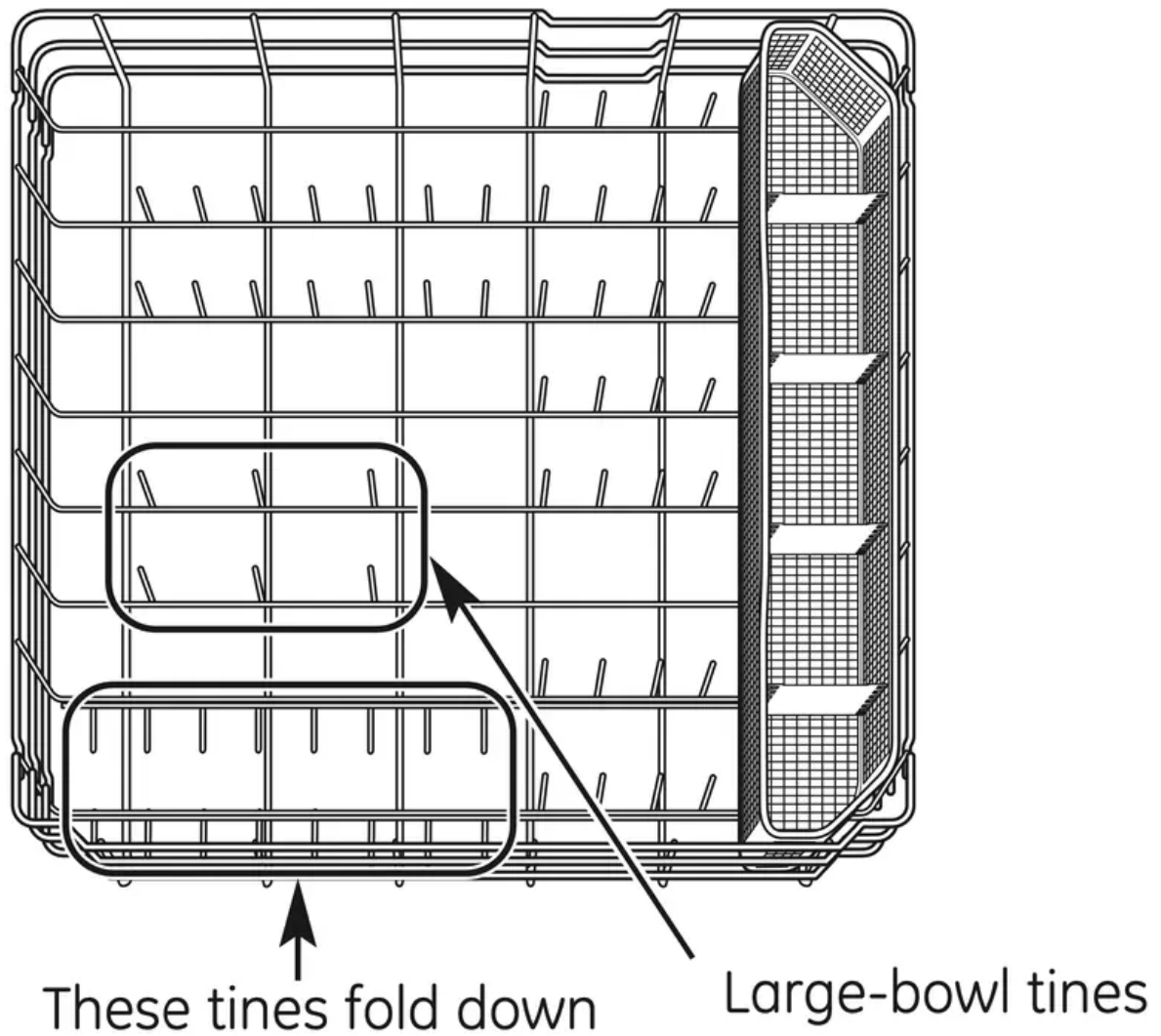

Loading place settings

Follow these guidelines for loading 10 place settings. Features and appearance of racks and silverware baskets may vary from your model.

NOTE: Silverware should be individually loaded into the slots on the silverware basket lid.

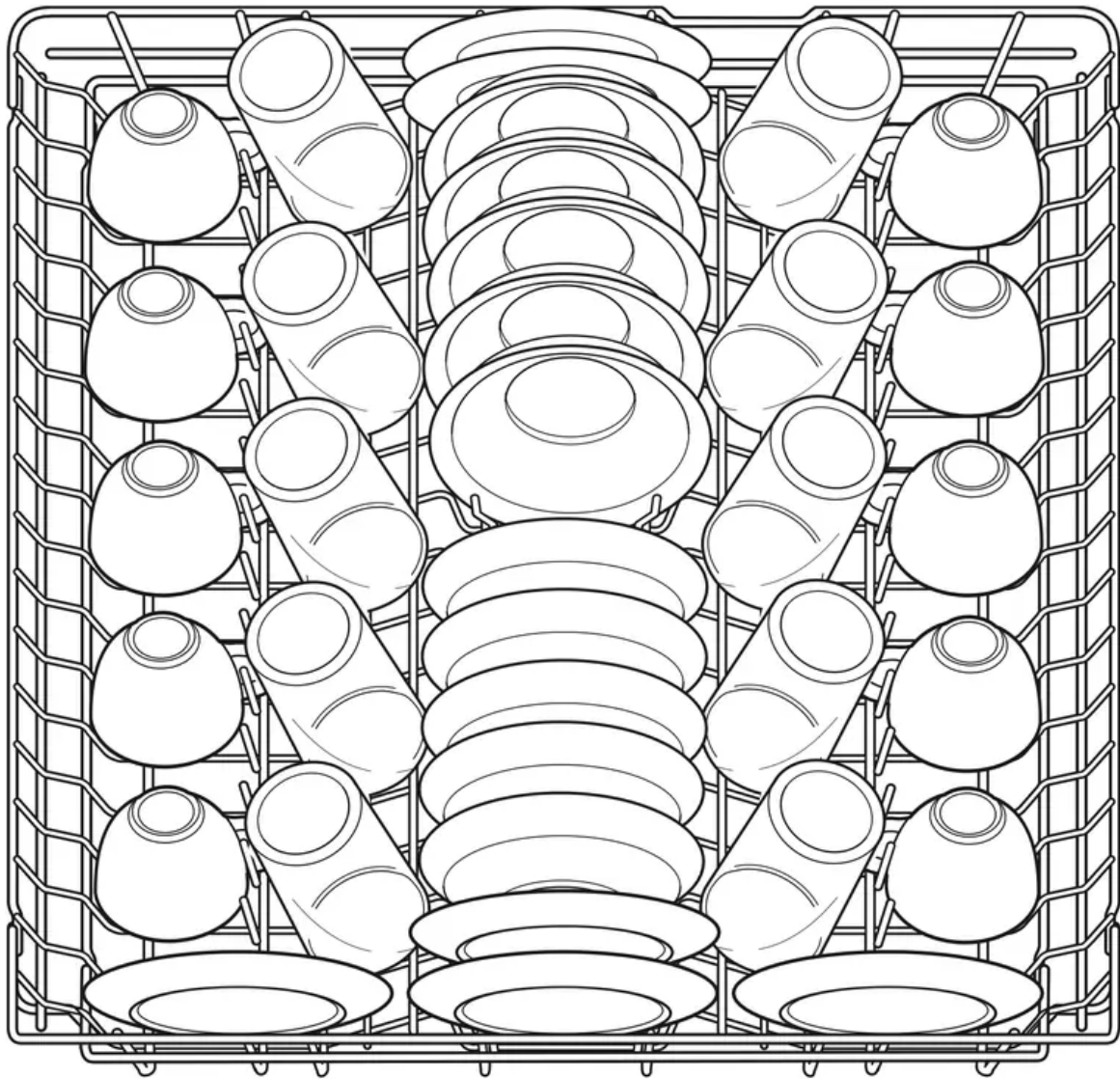

Upper Rack-10 place settings

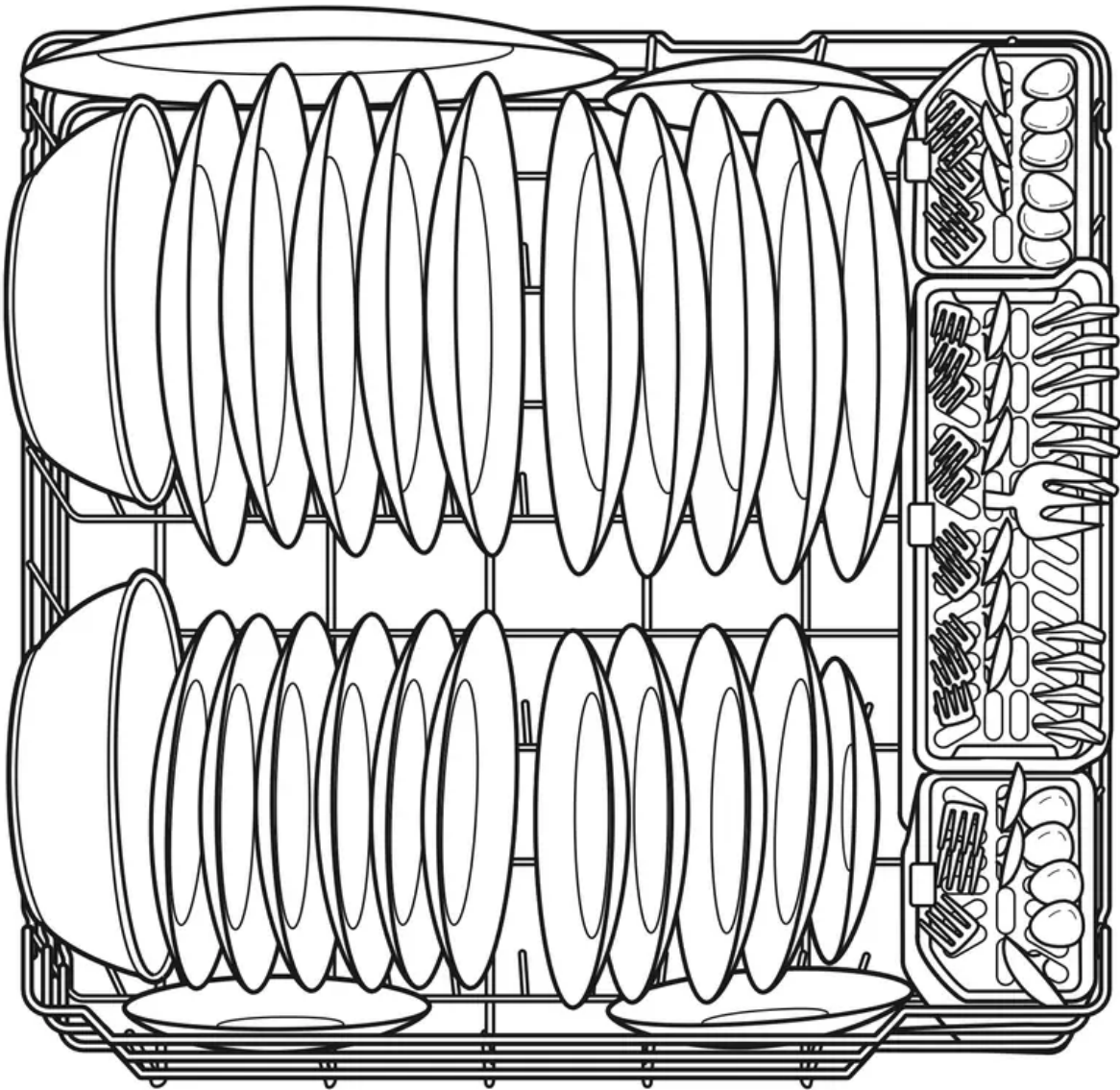

Lower Rack-10 place settings

Follow these guidelines for loading 12 place settings. Features and appearance of racks and silverware baskets may vary from your model.

NOTE: Silverware should be individually loaded into the slots on the silverware basket lid.

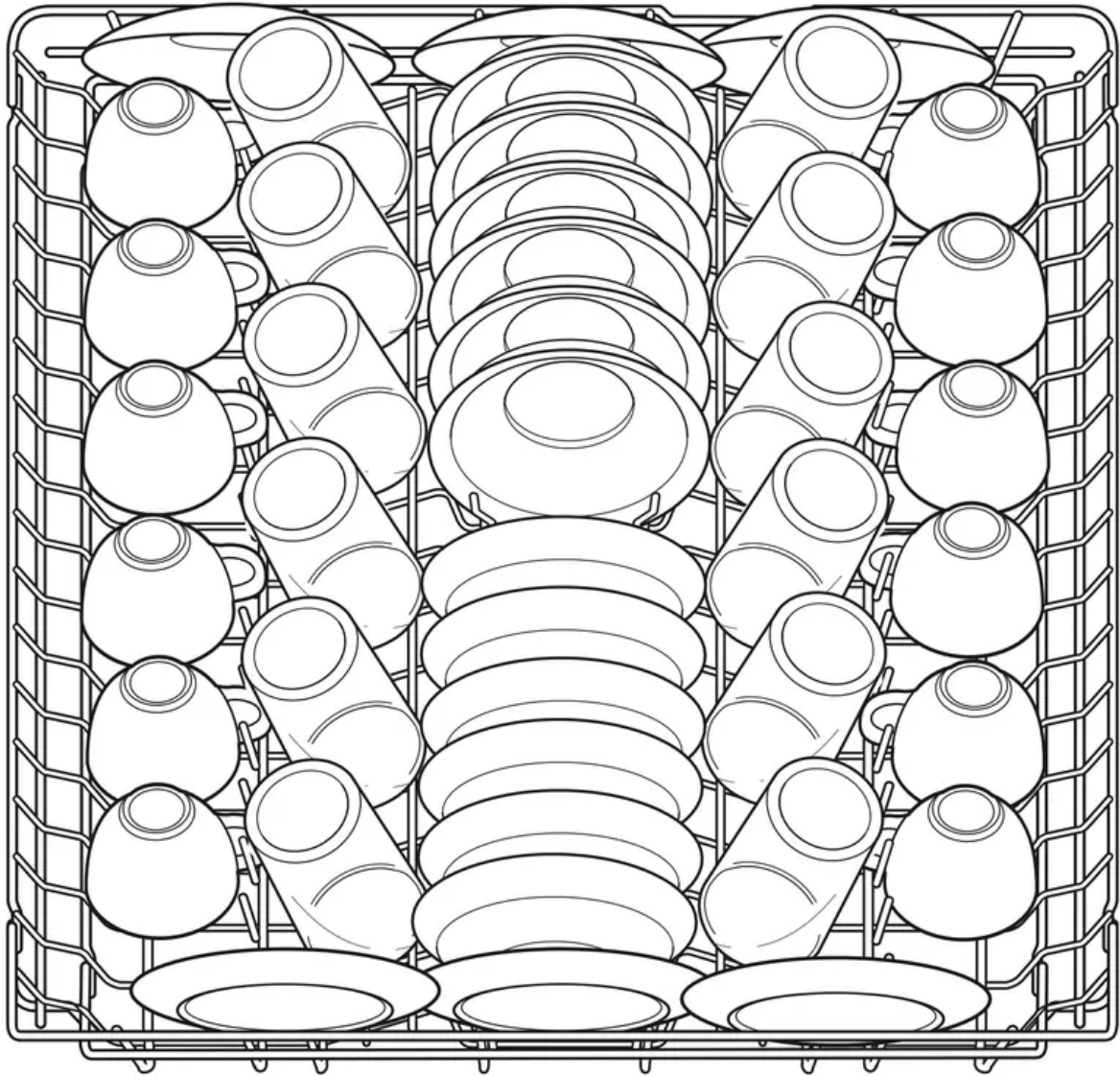

Upper Rack - 12 place settings



NOTE: Do not place large objects in the front-left corner of the lower rack.

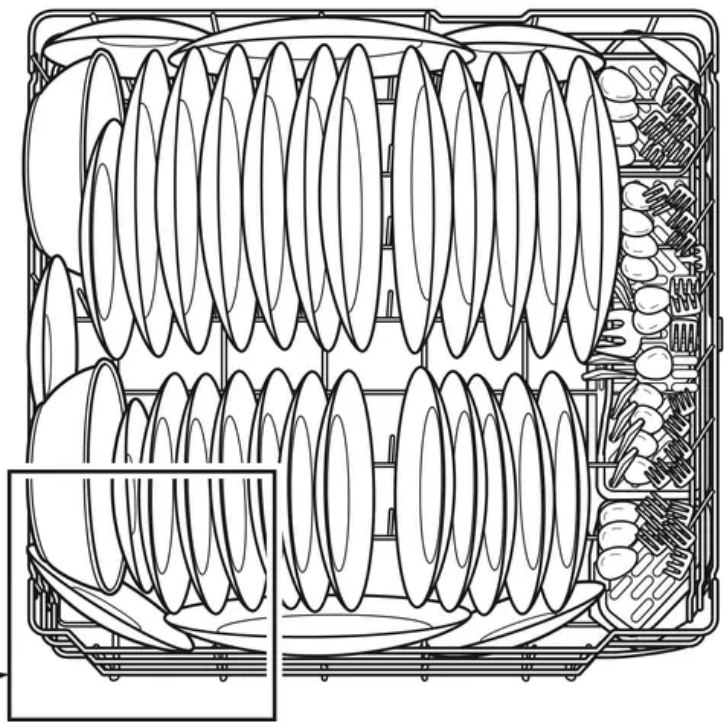

Lower Rack - 12 place settings

Caring for the dishwasher

Cleaning the Exterior Door Panel

Before cleaning the front panel, make sure you know what type of panel you have. Refer to the last two letters of your model number. You can locate your model number on the left-hand tub wall just inside the door. If your model number ends with BB, CC, WW, SA or BG, then you have a Painted Door panel. If your model number ends with SS, then you have a Stainless Steel Door panel. If your model number ends with CS, then you have a Clean Steel panel.

Follow the instructions below for cleaning the door panel for your specific model.

Painted Door Panel (model numbers ending in BB-black, CC-bisque, WW-White, SA-silver metallic or BG-graphite black)

Use a clean, soft, lightly dampened cloth, then dry thoroughly. You may also use a good appliance wax or polish.

Stainless Steel Door Panel (model number sending in SS)

The stainless steel panels can be cleaned with Stainless Steel Magic or a similar product using a clean, soft cloth. Do not use appliance wax, polish, bleach or products containing chlorine on Stainless Steel doors.

You can order Stainless Steel Magic #WX10X15 through GE Parts by calling 800.626.2002.

CleanSteel Door Panel (model number sending in CS)

Use a clean, soft, lightly dampened cloth, then dry thoroughly. Do not use appliance wax, polish or any chemical agent on CleanSteel doors.

Do not wipe the dishwasher with a soiled dish cloth or wet towel. These may leave a residue. Do not use scouring pads or powdered cleaners because these products can scratch the finish.

Stainless Steel Interior-Tub and Inner Door

The stainless steel used to make the dishwasher tub and inner door provides the highest reliability available in a GE dishwasher. If the dishwasher tub or inner door should be scratched or dented during normal use, they will not rust or corrode. These surface blemishes will not affect their function or durability.

Cleaning the Control Panel

To clean the control panel, use a lightly dampened cloth. Then dry thoroughly.

Protect Against Freezing

If your dishwasher is left in an unheated place during the winter, ask a service technician to:

1. Cut off electrical power to the dishwasher. Remove fuses or trip circuit breaker.
2. Turn off the water supply and disconnect the water inlet line from the water valve.
3. Drain water from the water inlet line and water valve. (Use a pan to catch the water).
4. Reconnect the water inlet line to the water valve.

Does Your Dishwasher Have an Air Gap?

An air gap protects your dishwasher against water backing up into it if a drain clogs. The air gap is not a part of the dishwasher. It is not covered by your warranty. Not all plumbing codes require air gaps, so you may not have one. If the air gap gets clogged, the dishwasher will not drain. Clean the air gap if the dishwasher will not drain.

The air gap is easy to clean.

1. Turn off the dishwasher and lift off the cover.
2. Remove the plastic cap and clean with a toothpick.

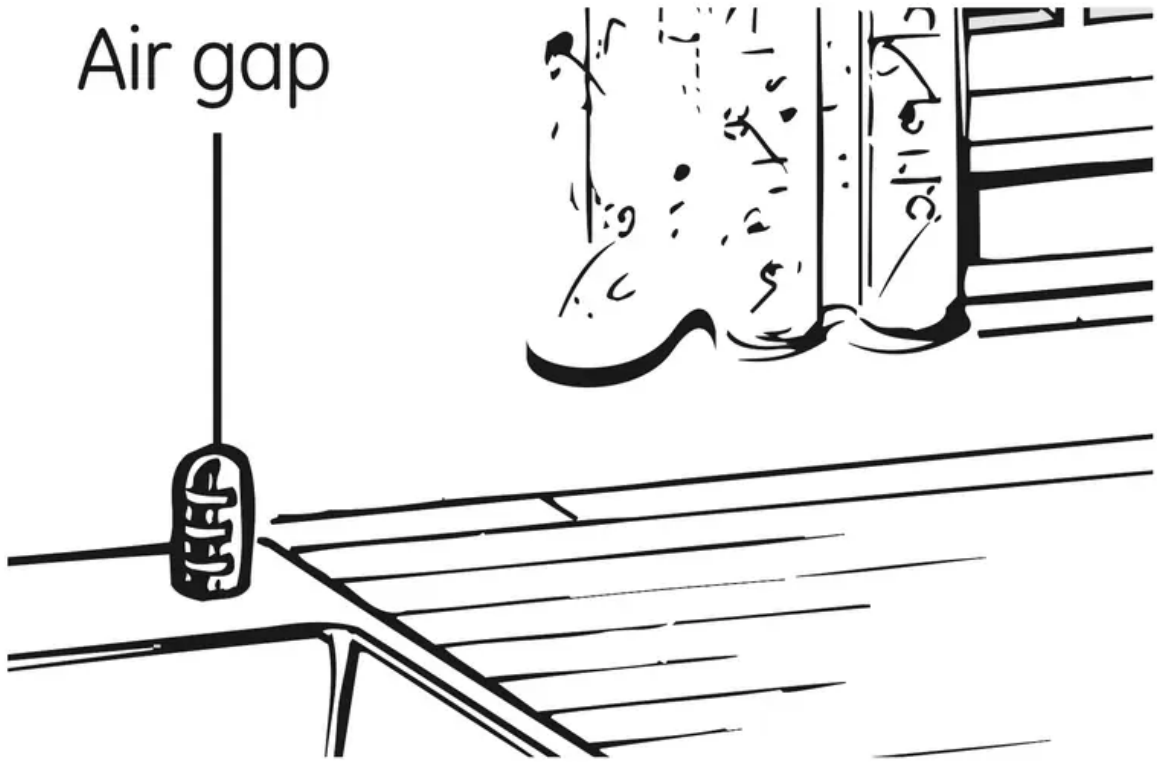

Check the air gap any time your dishwasher isn't draining well.



Troubleshooting



| Error Messages | Possible Causes | What To Do |
|---|---|---|
| Dishwasher BEEPS once every minute | This is a reminder that your dishwasher door has been left open during operation. It will continue beeping until you close the door. | <ul style="list-style-type: none"> • Close and latch the door after opening it mid-cycle. |
| Beeping at the end of the cycle | This is normal. The dishwasher will beep twice at the end of the cycle. | <ul style="list-style-type: none"> • To turn off the double beep indicator (or re-activate it if it was previously turned off), press the HEATED DRY pad 5 times within 3 seconds. • A triple beep will sound to indicate the end-of-cycle beep option has been turned on or off. |
| Dishes and flatware not clean | Low inlet water temperature. | <ul style="list-style-type: none"> • Make sure inlet water temperature is correct (see page 10). Turn on the hot water faucet nearest the dishwasher, let run until the water temperature stops rising. Then start the dishwasher and turn off the faucet. This insures the entering water is hot. |
| | Water pressure is temporarily low. | <ul style="list-style-type: none"> • Turn on a faucet. Is water coming out more slowly than usual? If so, wait until pressure is normal before using your dishwasher. |
| | Air gap or disposer is clogged. | <ul style="list-style-type: none"> • Clean the air gap or flush the disposer. |
| | Improper rack loading. | <ul style="list-style-type: none"> • Make sure large dishware does not block the detergent dispenser or the wash arms. See the Loading the dishwasher racks section. |



| Error Messages | Possible Causes | What To Do |
|--|---|--|
| | No air gap or high drain loop. | <ul style="list-style-type: none"> • Verify that you have an air gap or a high drain loop. Refer to the Installation Instructions. |
| | Poor performing detergent. | <ul style="list-style-type: none"> • Use a highly rated detergent such as Cascade® Complete. |
| Spots and filming on glasses and flatware | Extremely hard water. | <ul style="list-style-type: none"> • Use rinse agents such as Cascade® Rinse Aid™ to remove spots and prevent new film buildup. |
| | Low inlet water temperature. | <ul style="list-style-type: none"> • Make sure water temperature is at least 120°F. |
| | Overloading or improper loading of the dishwasher. | <ul style="list-style-type: none"> • Load dishwasher as shown in the Loading Place Settings section. |
| | Old or damp powder detergent. | <ul style="list-style-type: none"> • Make sure detergent is fresh. |
| | Rinse agent dispenser empty. | <ul style="list-style-type: none"> • If water is extremely hard, a softener may be required. |
| | Too little or low performing detergent. | <ul style="list-style-type: none"> • Make sure you use the proper amount of highly rated detergent. |
| Cloudiness on glassware | Combination of soft water and too much detergent. | <ul style="list-style-type: none"> • This is called etching and is permanent. To prevent this from happening, use less detergent if you have soft water. Wash glassware in the shortest cycle that will get it clean. |
| | Low performing phosphate free detergent. | <ul style="list-style-type: none"> • See White film on inside surface page 20. |

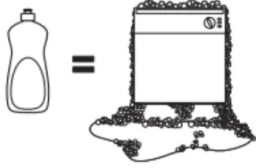

| Error Messages | Possible Causes | What To Do |
|--|---|---|
| | <p>Water temperature entering the dishwasher exceeds 150°F (66°C).</p> | <ul style="list-style-type: none"> • This could be etching. Lower the water heater temperature. |
| <p>Suds in the tub</p> | <p>Correct detergent wasn't used</p>  | <ul style="list-style-type: none"> • Use only automatic dishwasher detergents to avoid sudsing. Cascade® Automatic Dishwashing Detergents have been approved for use in all GE dishwashers. • To remove suds from the tub, open the dishwasher and let suds dissipate. Close and latch the dishwasher door. Pump out water by touching the START/RESET button once; then 30 seconds later, touch the START/RESET button again. Repeat if necessary. |
| | <p>Rinse agent was spilled</p> | <ul style="list-style-type: none"> • Always wipe up rinse agent spills immediately. |
| <p>Detergent left in dispenser cups</p> | <p>Dishes are blocking the detergent cup</p> | <ul style="list-style-type: none"> • Reposition the dishes, so the water from the lower spray arm can flush the detergent cup. See pages 15 and 16. |
| <p>Black or gray marks on dishes</p> | <p>Aluminum utensils have rubbed against dishes</p> | <ul style="list-style-type: none"> • Remove marks with a mild, abrasive cleaner. |
| <p>Dishes don't dry</p> | <p>Low inlet water temperature</p> | <ul style="list-style-type: none"> • Make sure inlet water temperature is at least 120°F. • Select HEATED DRY. • Use ADDED HEAT options. • Select a higher cycle, such as SANI WASH/SANITIZE or DEEP CLEAN. |

| Error Messages | Possible Causes | What To Do |
|---|--|--|
| | Rinse agent dispenser is empty | <ul style="list-style-type: none"> • Check the rinse agent dispenser and fill as required. |
| Control panel responded to inputs but dishwasher never filled with water | Door latch may not be properly seated | <ul style="list-style-type: none"> • Make sure the door is firmly closed. |
| | Water valve may be turned off | <ul style="list-style-type: none"> • Make sure water valve (usually located under the sink) is turned on. |
| Stained tub interior | Some tomato-based foods can cause reddish stains | <ul style="list-style-type: none"> • Use of the RINSE AND HOLD cycle after adding the dish to the load can decrease the level of staining. |
| | Tea or coffee stains | <ul style="list-style-type: none"> • Remove the stain by hand, using a solution of 1/2cup bleach and 3 cups warm water. WARNING: Before cleaning interior, wait at least 20 minutes after a cycle for the heating elements to cool down. Failure to do so can result in burns. |
| | An overall yellow or brown film can be caused by iron deposits in water | <ul style="list-style-type: none"> • A special filter in the water supply line is the only way to correct this problem. Contact a water softener company. |
| Dishwasher won't run | Dishwasher door is not closed and latched | <ul style="list-style-type: none"> • Dishwasher door must be closed and latched for dishwasher to operate. |
| | Fuse is blown or circuit breaker | <ul style="list-style-type: none"> • Replace fuse or reset circuit breaker. Remove any other appliances from the circuit. |
| | Power is turned off | <ul style="list-style-type: none"> • In some installations, the power to the dishwasher is provided through a wall |

| Error Messages | Possible Causes | What To Do |
|--|--|--|
| | | switch, often located next to the disposer switch. Make sure it is on. |
| | Control panel is locked | <ul style="list-style-type: none"> • Unlock control panel. See page 8. |
| | Reboot your control | <ul style="list-style-type: none"> • Turn off power to the dishwasher (circuit breaker or wall switch) for 30 seconds; then turn back on. |
| Control panel lights go off when you're setting controls | Time too long between touching of selected buttons | <ul style="list-style-type: none"> • Each button must be touched within 5 minutes of the others. To relight, touch any button again, or unlock and relatch door. |
| Water standing in the bottom of the tub | This is normal | <ul style="list-style-type: none"> • A small amount of clean water around the outlet on the tub bottom at the back of the tub keeps the pump seal lubricated. |
| Water won't pump out of the tub | Drain is clogged | <ul style="list-style-type: none"> • If you have an air gap, clean it. See page 17. • If the dishwasher drains into a disposer, run disposer clear. • Check to see if your kitchen sink is draining well. If not, you may need a plumber. |
| Steam | This is normal | <ul style="list-style-type: none"> • Warm, moist air comes through the vent by the door latch during drying and when water is being pumped out (front-control models) . This is normal and necessary for drying. |
| Sanitized light does not illuminate at the end of the cycle | The door was opened and the cycle was interrupted during or | <ul style="list-style-type: none"> • Do not interrupt the cycle anytime during or after main wash. |

| Error Messages | Possible Causes | What To Do |
|---|---|--|
| | <p>after the main wash portion.</p> | |
| | <p>The incoming water temperature was too low</p> | <ul style="list-style-type: none"> • Raise the water heater temperature to between 120°F and 140°F. |
| | <p>The cycle is complete and the door has been open for longer than 60 seconds</p> | <ul style="list-style-type: none"> • This is normal. No action is required. |
| <p>Noise</p> | <p>Normal operating sounds</p> <p>Detergent cup opening</p> <p>Water entering dishwasher</p> <p>The motor stops and starts at various times during the cycle</p> <p>Drain pump sounds during pump out</p> | <ul style="list-style-type: none"> • These are all normal. No action is required. |
| | <p>Rattling dishes when the spray arm rotates</p> | <ul style="list-style-type: none"> • Make sure dishes are properly loaded. See the Loading the dishwasher racks section. |
| <p>A white film on glassware, dishware and the interior</p> | <p>This problem caused by phosphate-free dishwasher detergent</p> | <ul style="list-style-type: none"> • To remove the white film, run your dishes through a dishwasher cycle with citric acid. You may purchase a citric acid kit from GE by calling 1-800-626-2002 and asking for WD35X151. Alternatively, you can purchase citric acid crystals from your local supermarket. Pour the citric acid in the detergent cup |



| Error Messages | Possible Causes | What To Do |
|----------------|-----------------|--|
| | | <p>and close the cover. Place the filmed but otherwise clean glassware and dishware in the dishwasher.</p> <p>Leave silverware and other metal items out of the dishwasher. Turn the dishwasher on and let it run through a complete cycle without detergent.</p> <p>The glassware, dishware, and dishwasher should come out film free. Alternatively, a vinegar rinse may be used. Pour 1 cup of vinegar into dishwasher just after the detergent cup opens and let the dishwasher complete its cycle. This may be repeated several times a year as needed.</p> <p>The use of a rinse agent such as Cascade® Rinse Aid™ may help minimize a repeat build up of film. Also, the use of a highly rated detergent such as Cascade® Complete Action Pads will help prevent film build-up.</p> |

Warning

This content is compiled from multiple sources and is provided for reference purposes only. It may not be complete or fully applicable to all situations. If you are unable to resolve your issue, please contact the product manufacturer or an authorized service provider for official support.

