

## What's in the Box

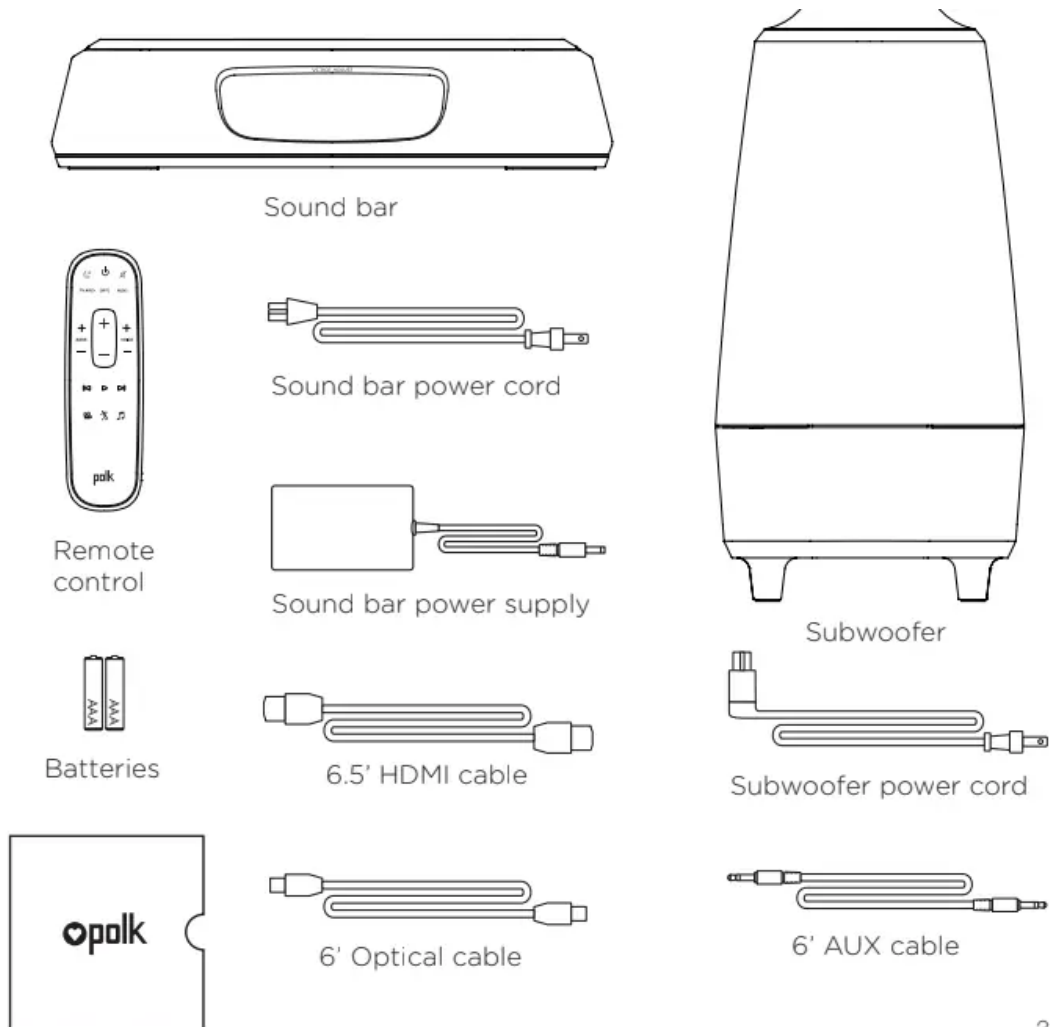

## Connecting Your MagniFi Mini to Your TV

Is an HDMI input jack on your TV labeled "ARC"?

1a. You **MUST** have an HDMI ARC input on your TV to use HDMI.



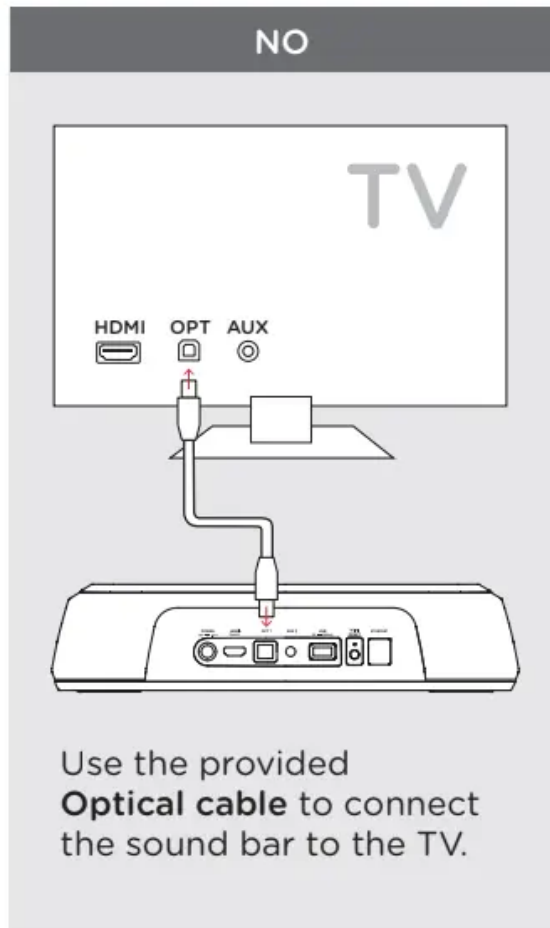
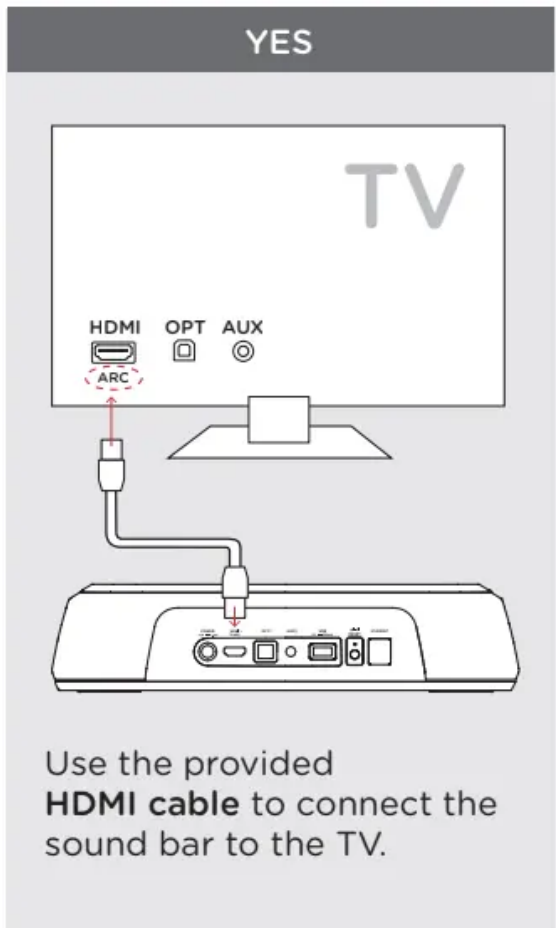

1b. Don't have HDMI or Optical input available on your TV?

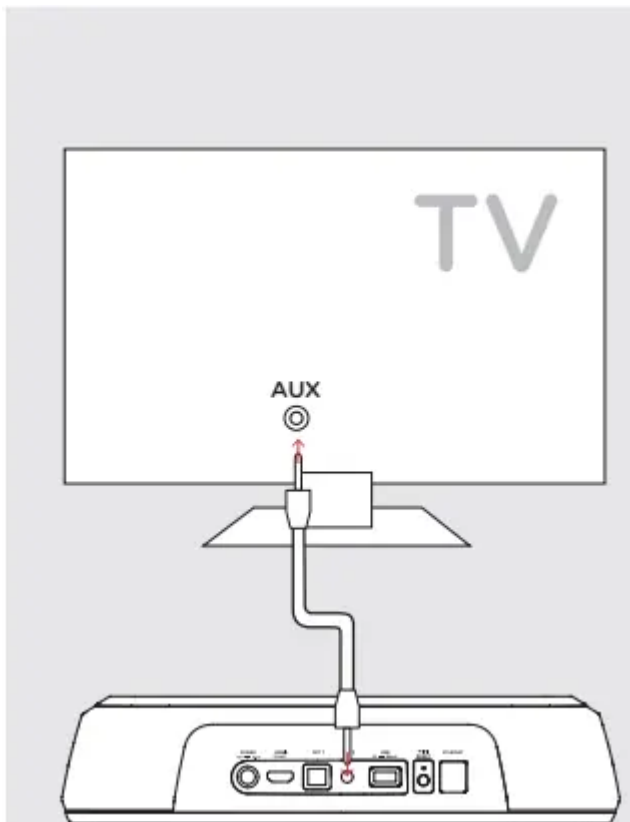

If your TV does not have an HDMI ARC or optical output, connect the sound bar to the TV with the provided AUX cable.

(Only HDMI and optical inputs support Dolby 5.1 decoding)

## 2. Remote battery installation

Insert the provided AAA batteries.

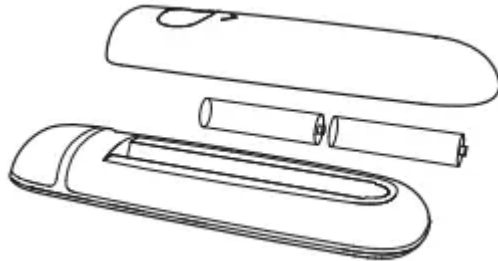

## 3. Connect the sound bar power cord to an AC outlet

A red LED will pulse on the front of the sound bar indicating boot up.

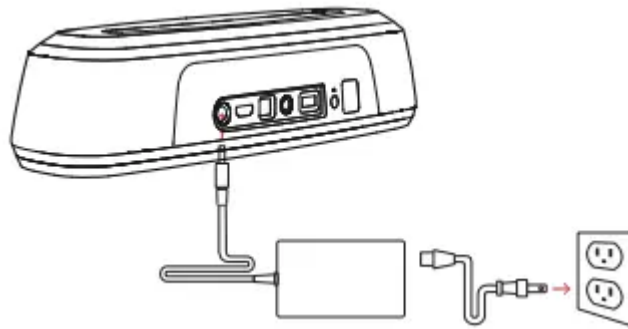

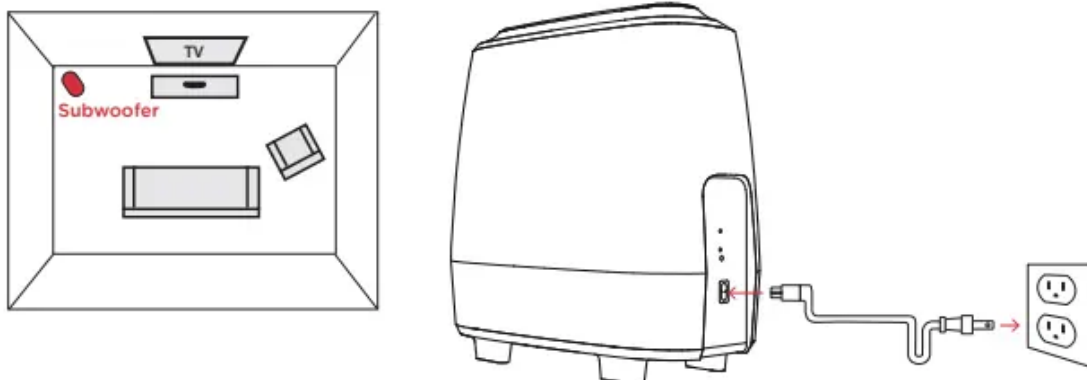

## 4. Position subwoofer and connect to an AC outlet

(for best performance place on the same wall as the TV)



**NOTE: The MagniFi Mini sound bar and wireless subwoofer are preset at the factory to work together.** Should your wireless subwoofer stop receiving an audio signal, follow these instructions to re-establish the connection:

1. Turn on your sound bar. On the sound bar simultaneously press and hold the Bluetooth button  and the source button  for 3 seconds.
  2. Press and hold the SYNC button on the back of the subwoofer for 3 seconds.
  3. The green LED on the back of the subwoofer will start flashing at a faster rate, indicating that the sound bar and the subwoofer are connecting, the LED is solid green when connected.
5. Turn on your sound bar

Press the Power button  on the sound bar or remote.

NOTE: make sure TV internal speakers are off when using optical and aux inputs.

## Remote Control

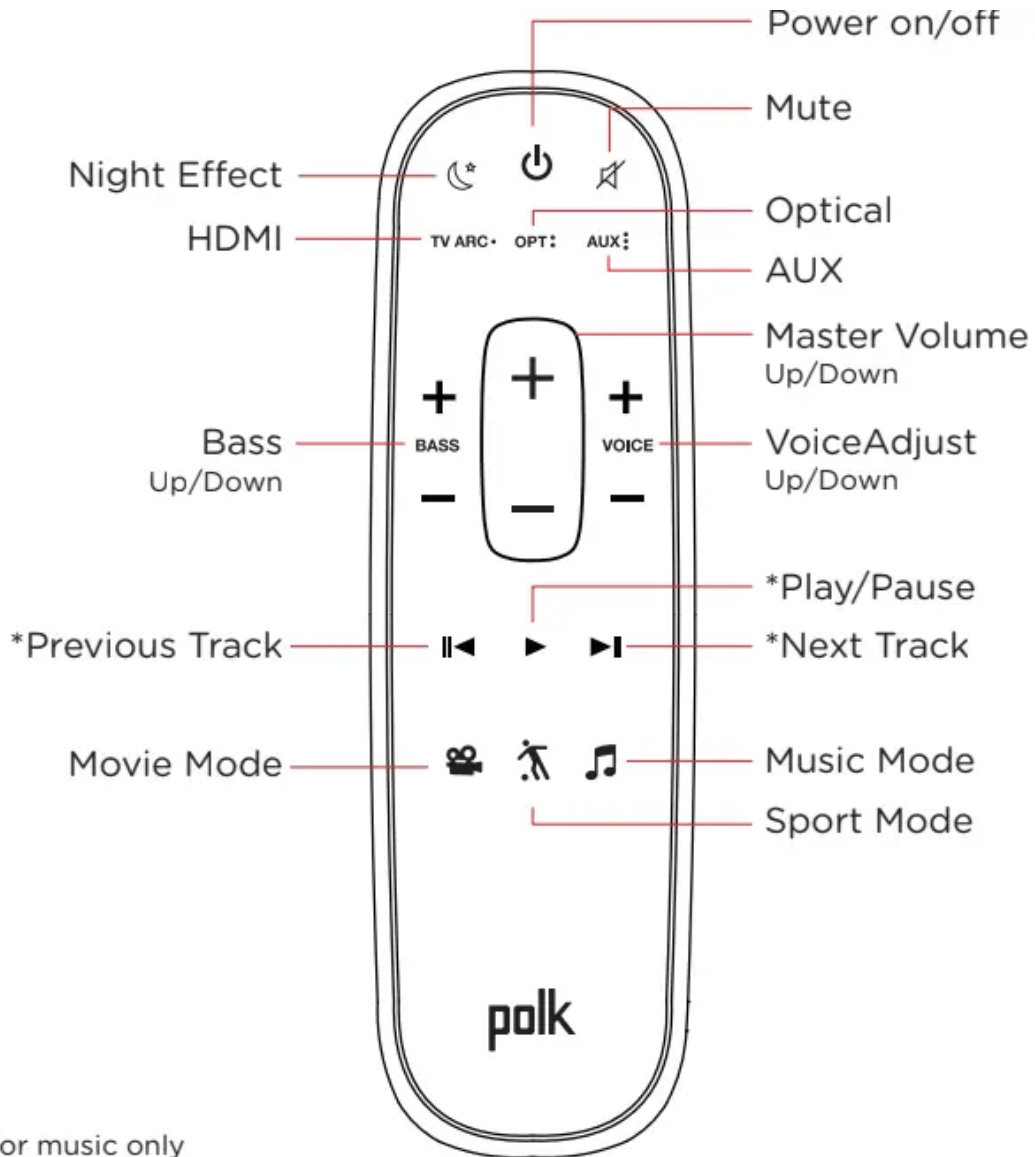

\*For music only

## Sound Bar Top Panel

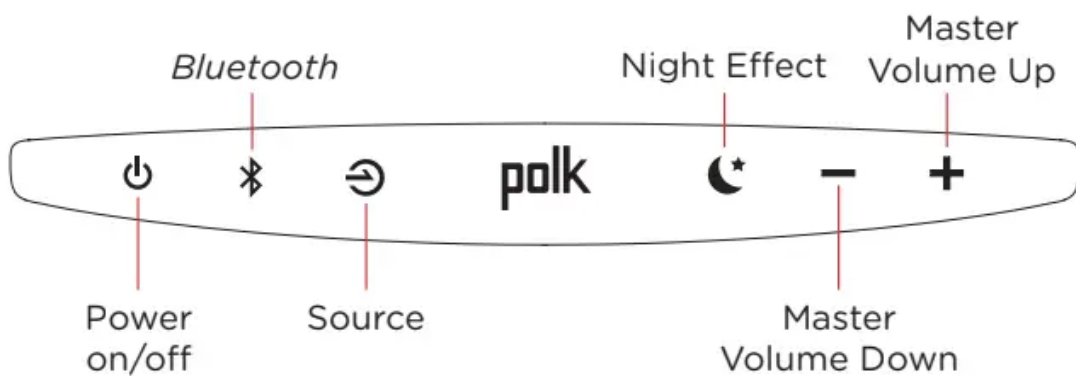

## Sound Bar Back Panel

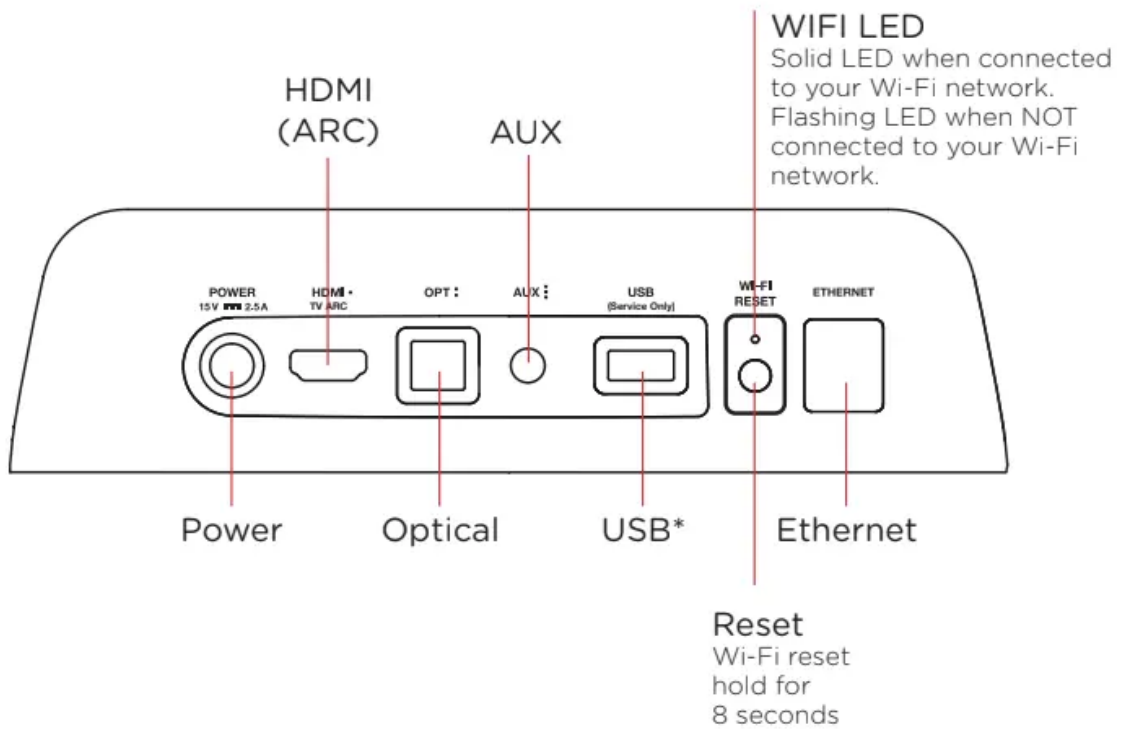

## Sound Bar LEDs

The MagniFi Mini has a vertical row of LED lights that provide status indications, like source, volume and listening modes.

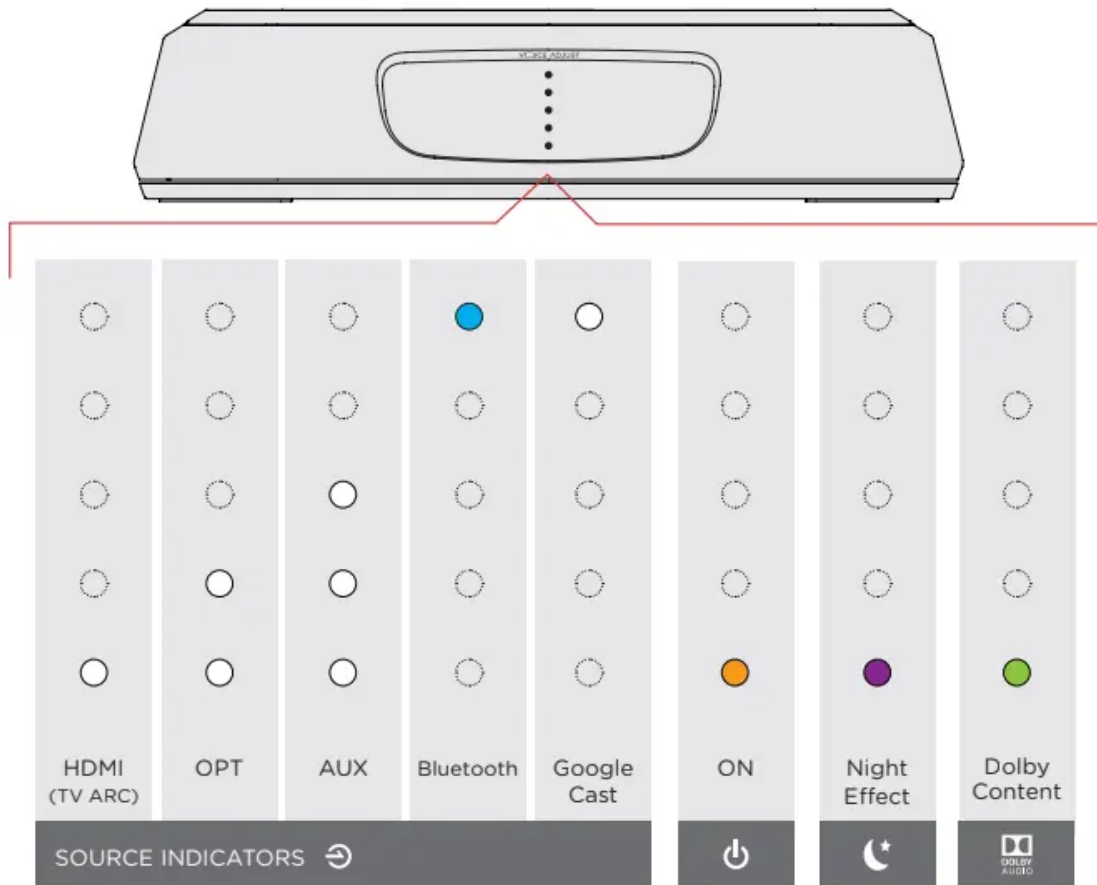

## Using Your TV or Cable/Satellite Remote (IR only) to Control the MagniFi Mini

The MagniFi Mini works best with the included remote, however you can also teach it to respond to your favorite TV or cable IR remote by following these steps:

**IMPORTANT:** Hold both remotes about 12" (30cm) directly in front of the MagniFi Mini when pressing their respective buttons, make sure you wait at least 1 second between button presses, make sure your remotes have fresh batteries

1. Enter learn mode by pressing and holding the Source  button on the sound bar until you hear a tone and the lights on the front of the sound bar pulse up and down.
2. Press and release the button on the MagniFi Mini remote that you want to learn (ex: Volume Up).
3. Press and Release the corresponding button on YOUR remote repeatedly until you hear a two note ascending tone. NOTE: Make sure you wait at least 1 second between button presses!
4. Repeat steps 2 and 3 to learn Volume Down, Mute, and Power buttons from your remote.

5. Exit learn mode by pressing and holding the  Source button on the sound bar again until you hear a tone and the lights on the front of the sound bar stop pulsing.
6. Verify that your remote can control the buttons you programmed (ex: Volume up) on the MagniFi Mini.

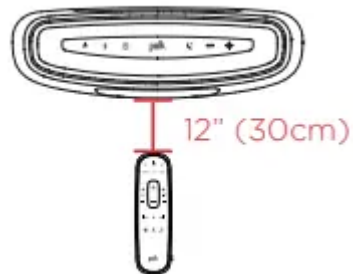

**NOTE:**

- You will hear a different (descending) tone if the command failed to learn. Please try again.
- MagniFi Mini will exit Learn mode after 1 minute of in activity, saving any learned codes

## Optimizing Your Listening Experience

### Bass Control

#### Control Bass Volume Levels

Easily adjust bass volume for more or less impact.

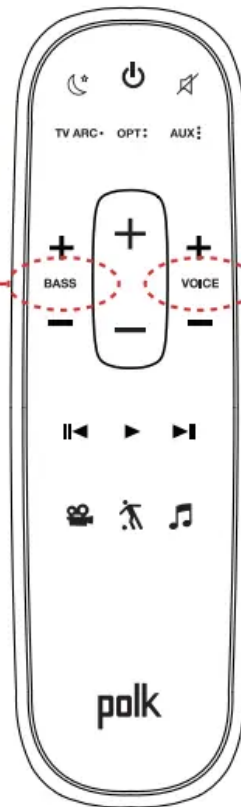
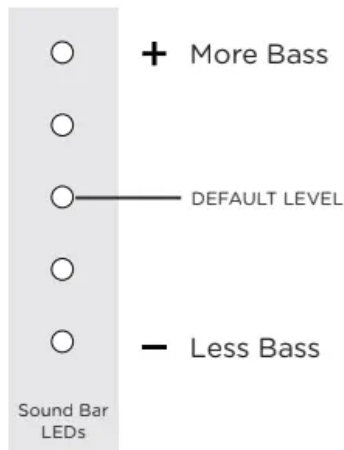

### VOICE ADJUST™

#### Control Dialogue Volume Levels

Isolate and adjust the voice channel level to reproduce clear, crisp dialogue.

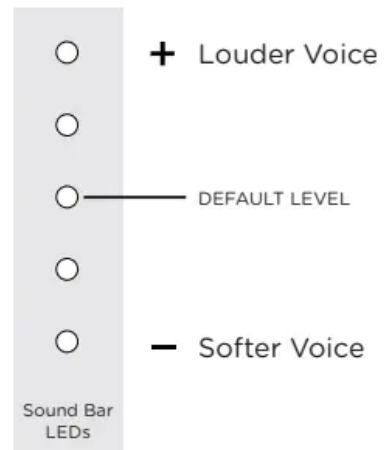

12



#### Movie Mode

Enhances audio reproduction in TV and movies.



#### Music Mode

Enhances audio whenever you're listening to music, or watching TV or movies that have music playing in them.



#### Sport Mode

Enhances audio whenever you're watching sporting events, news and talk shows.



## Night Effect

Reduces bass and volume dynamics while improving voice intelligibility for low-volume listening.

## Music Services

### How to Set Up Google Cast™

1. Power on the sound bar.
2. From your phone, tablet or computer visit: chromecast setup
3. Download the Google Home app, click on the devices tab within the app and select MagniFi Mini. Follow in app setup instructions.



4. When you're streaming Google Cast, a white LED will appear on the sound bar.

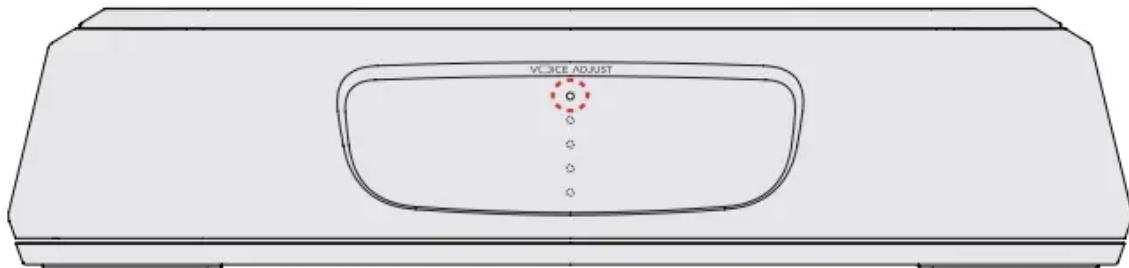

How to hear your TV again: When you are finished using Google Cast, press the source button on the sound bar or remote (TV ARC, OPT, AUX).

### How to Set Up Bluetooth®

1. To enable Bluetooth, press the Bluetooth button  on the sound bar. A blue LED will slowly pulse on the sound bar.

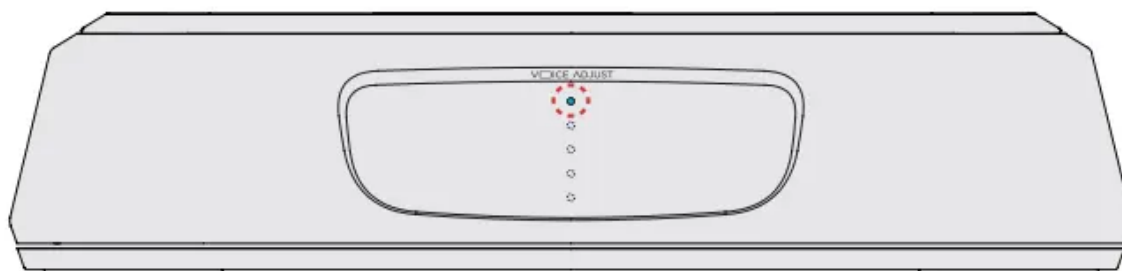

2. Go to the Bluetooth devices section on your phone, tablet or computer and select Polk MagniFi Mini. The LED is solid blue when Bluetooth is connected.

**Note:** To take control when another device is connected, press the Bluetooth button.

How to hear your TV again: When you are finished using Bluetooth, press the source button on the sound bar or remote (TV ARC, OPT, AUX).

### **Warning**

This content is compiled from multiple sources and is provided for reference purposes only. It may not be complete or fully applicable to all situations. If you are unable to resolve your issue, please contact the product manufacturer or an authorized service provider for official support.