

## Scan to download APP

Thanks for buying our robot vacuum cleaner. Please read this manual carefully before use. Please follow up the manual during operation for your safe.

There are wifi-version and non-wifi version of our C30B model.

If your robot is wifi-version, please read the Quick Guide for APP Using in the next page; If your robot is non-wifi version, please skip the page of Quick Guide for APP Using.

\*\*\*Please make sure that your robot, your router, and your phone are close to each other before you start APP connection.





**Suggested distance: less than 4M**

# Quick Guide for App Using

For Wifi-version C30B only

## 1. App Downloading

For Wifi-version C30B only Search “Tuya” from your APPSTORE or google play; download the APP [Fig 1]; Open “Tuya” on your cellphone after download [Fig 2]; Register an account via email or cell phone number [Fig 3] (tap the right Verification Code and Set up a password for your Tuya ID [Fig 4]); Login with account and password [Fig 5].

\*\*\*Important\*\*\*: Before WIFI connection, turn on the robot; After the voice prompts “Welcome to use sweeping robot”, please press the start button  continuously twice, then the voice prompts “connecting network”, and the WIFI icon  begins to flash constantly; Your robot is initialized.

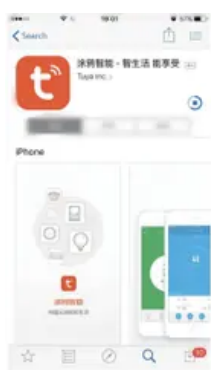

Fig 01



Fig 02

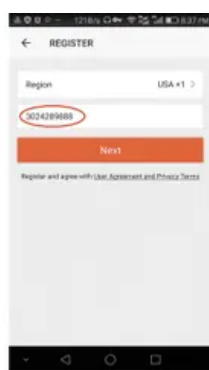

Fig 03

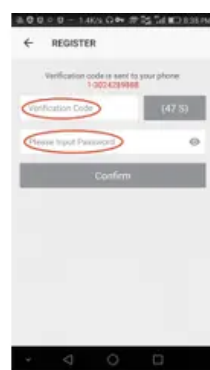

Fig 04

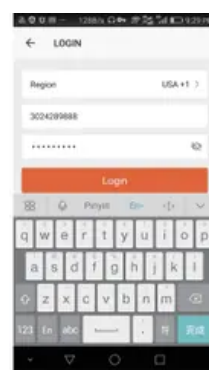

Fig 05

Tap + on the top right corner to add device [Fig 6]; Tap All [Fig 7]; Choose Robot Vacuum [Fig 8]; Click Confirm indicator rapidly blink [Fig 9];

Type your WIFI Password [Fig 10] and start device connection [Fig 11]; Adding device succeeded [Fig 12].

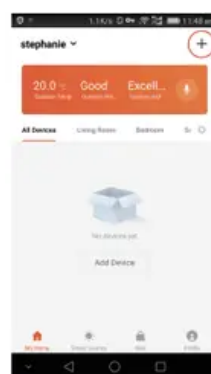

Fig 06

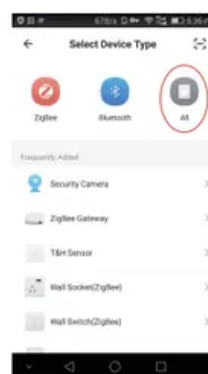

Fig 07

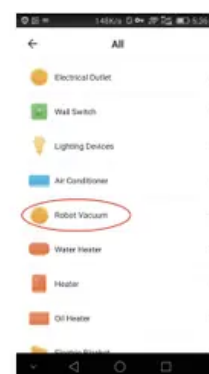

Fig 08

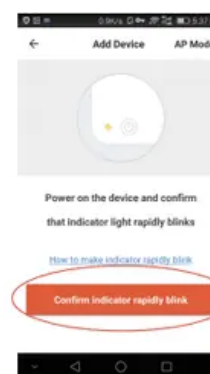

Fig 09

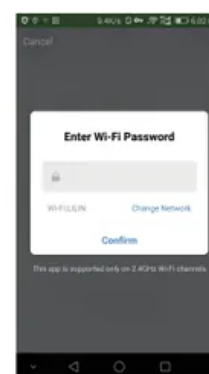

Fig 10

Rename your device, e.g. Robot C30 [Fig 13]; Start using App to control your robot [Fig 14].





Fig 11

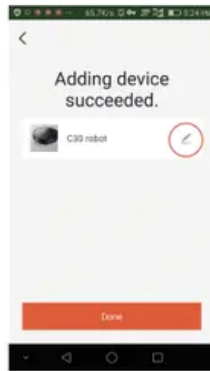

Fig 12

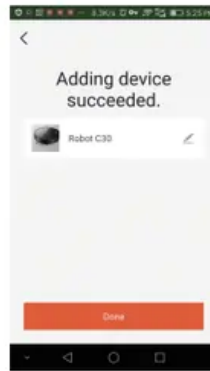

Fig 13

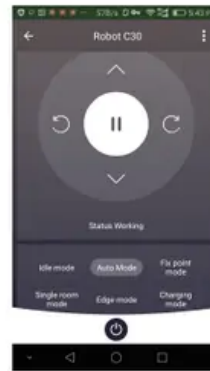

Fig 14

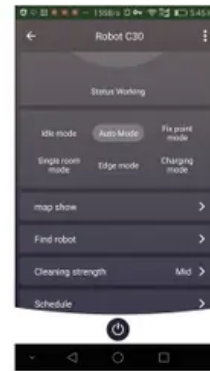

Fig 15

## 2. APP Operation

You may click “Auto Mode”, “Fix point mode”, “Single room mode”, “Edge mode”, “Charging mode” as you want to start certain cleaning mode [Fig 15]; Choose Cleaning strength to enter suction power setting interface [Fig 16];

## 3. Scheduling

For Wifi-version C30B only Choose Schedule to enter scheduling interface and Choose “Add Schedule” [Fig 17]; choose the proper working time [Fig 18] and day (multiple Mon-Sun) [Fig 19].

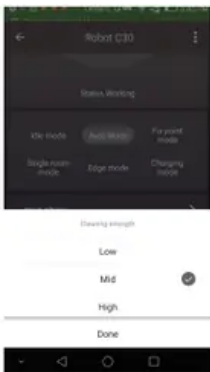

Fig 16

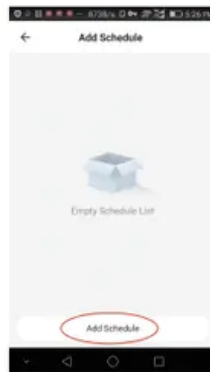

Fig 17



Fig 18

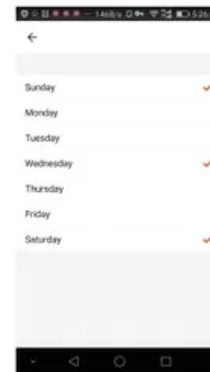

Fig 19

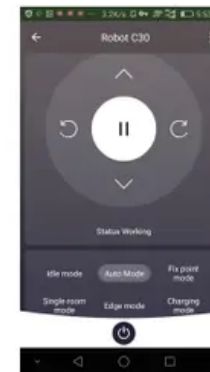





Fig 20

4.

## Pause/ Standby/ Sleeping mode

Press  , the robot will pause [Fig 20] [Fig 21]; Or press Idle mode, the robot will pause [Fig 22]; Press the On/Off symbol  on your App to make the robot enter standby/sleeping mode.

**Note:** When it is in sleeping mode, the App page turns darker [Fig 23]; If it is in sleeping mode, press the On/Off symbol  , the robot will be waken up to standby mode [Fig 24]; Press the cleaning mode as you want to start working [Fig 25].

## 5. Working Map

The App will show the map of working cleaning path of the robot [Fig 26]; But it may not update in real time.

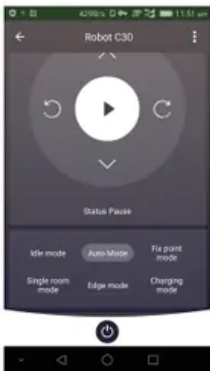

Fig 21

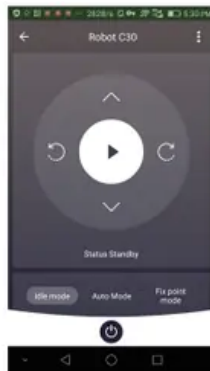

Fig 22

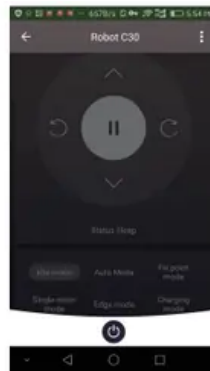

Fig 23

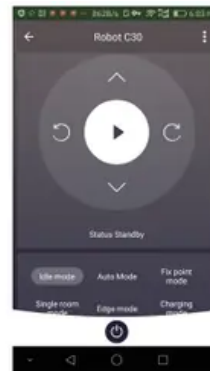

Fig 24

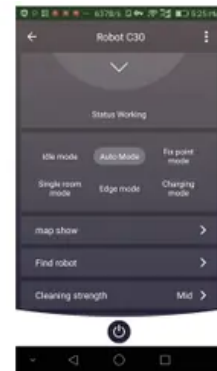

Fig 25

## 6. Find robot

You may not know where the robot is when it finishes cleaning and stops. Then press “Find robot” and “Confirm” [Fig 27]; then there is “Di” sound prompt for you to find the robot.

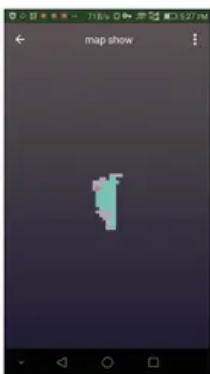

Fig 26

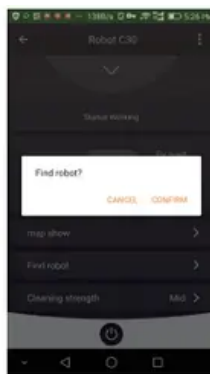

Fig 27

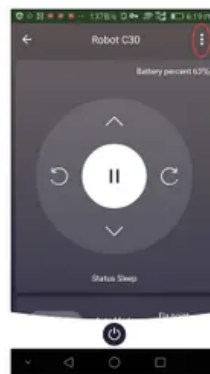

Fig 28

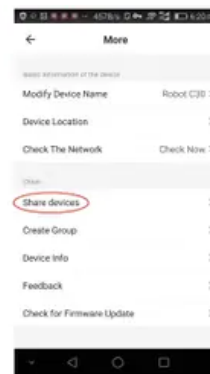

Fig 29

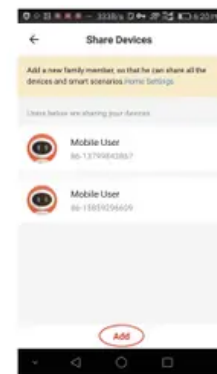



Fig 30

## 7. Share Devices

Only one main ID for one single device is available. If you want to share the device to others in your family, tap  on the top right corner [Fig 28]; Choose “Share devices” [Fig 29]; type correct registered cellphone number/ email ID to add additional users [Fig 30].

**Note:** other users have to register Tuya ID before added.

## 8. Reset WIFI

Changing the connection from existing WIFI network to new WIFI network, you need to re-connect your robot to the new WIFI network after initializing your robot as follows: turn on the robot, after the voice prompts “Welcome to use sweeping robot”, press the start button  twice continuously,

then the voice prompts “Connecting network”, and WIFI icon  begins to flash constantly, your robot is initialized; Then you could connect it to new network.

Thanks for buying our robots and wish you enjoy using.

**Notes:** The APP software is upgrading, the actual APP user interface may be different from the statements in this manual. Some functions may be added while some functions mentioned above may be deleted. As different countries has different networking policy, the real time map displaying function may be delayed or may not be fulfilled. Our company reserves the right to change the parameters without prior notice.

## Safety Regulation

Before using this product, please read the following safety instructions and follow all the safety precautions. Please read the instructions carefully. Please keep this instructions. Any operation inconsistent with this instruction manual may cause damage to this product.



### Note:

1. Only authorized technicians can disassemble this product. Users are not recommended to disassemble this product by themselves.
2. Please use the original power adapter only. Other adapters may caused damage to this product.
3. Do not touch wires, sockets or power adapters when your hands are wet.
4. Do not use cloth curtains or body parts to roll into the product drive wheels.
5. Do not place this product near cigarette butts, lighters and other smoldering fires.
6. Please clean the product after charging.
7. Do not bend wires excessively or place heavy objects and sharp objects on the machine.
8. This product is an indoor household product. Do not use it outdoors.
9. Do not sit on the product.
10. Do not use this product in wet environment (e.g. bathroom).
11. Before using this product, please remove all vulnerable items (e.g. glasses, lamps, etc.) on the ground as well as items (e.g. wires, paper sheets, curtains) that may entangle the side brushes and air suction passages.
12. Do not put this product in a place where it is easy to fall (e.g. on desks and chairs).
13. Please carefully check whether the power adapter is connected to the socket before use, otherwise the battery may be damaged.

14. To prevent tripping, please inform other members of the house when this product works.
15. Please empty the dust box before using this product when the dust box is full.
16. The temperature used for this product is 0 to 40 degrees celsius.
17. Do not use this product in high temperature environment.
18. Please remove the battery from the machine before the product is scrapped.
19. Please make sure that this product is not powered on when removing the battery.
20. Please recycle the discarded batteries safely



**Warning:**

1. Use only the original rechargeable battery and charging station specially equipped by the manufacturer. Non-rechargeable batteries are strictly prohibited, please refer to “product parameters” for battery specification information.
2. It is forbidden to use products in environments with open flames or fragile objects.
3. It is forbidden to use products in extremely hot ( above 40 °C ) or extremely cold ( below 0 °C ) weather.
4. It is forbidden for human hair, clothes, fingers and other parts to approach the opening and operating parts of the product.
5. It is forbidden to use products on wet or stagnant ground.
6. It is forbidden for products to absorb any articles such as stones and waste paper that may clog products.
7. It is prohibited for the product to absorb any inflammable substances, such as petrol, toner and toner for printers or photocopiers. It is also prohibited to use the product in clean areas with flammable items.
8. It is forbidden for products to absorb any burning articles, such as cigarettes, matches, ashes and other articles that may cause fire.
9. It is forbidden to place articles at the suction port. Do not use the product when the suction port is blocked. Clean up dust, cotton wool, hair etc. at the suction port to ensure smooth air circulation at the suction port.
10. Use the power cord carefully to avoid damage. It is forbidden to use the power cord to drag or pull the products and the product charging station. It is forbidden to use the power cord as a handle. It is forbidden to clamp the power cord in the crack of the door. It is forbidden to pull the power cord at sharp corners and corners. It is forbidden for the product to run on the power cord while the power cord should be far away from the heat source.
11. Do not use damaged charging station.

12. Even if the product has been severely damaged, burning of the product is prohibited, which may lead to explosion of the battery of the product.

## Product Composition / Package Contents



Host

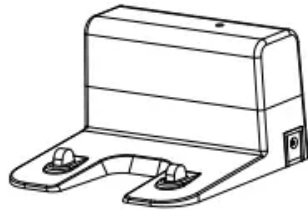

Charging Station



Remote Control

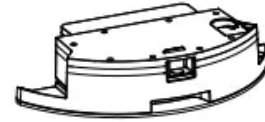

Water Tank



Dust Box



Mop



Cleaning Brush



Side Brushes

## Product Composition / Part Name

Top

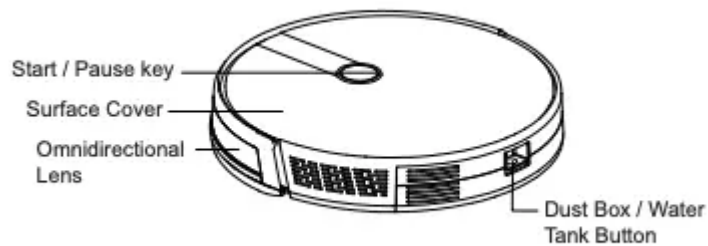

Bottom

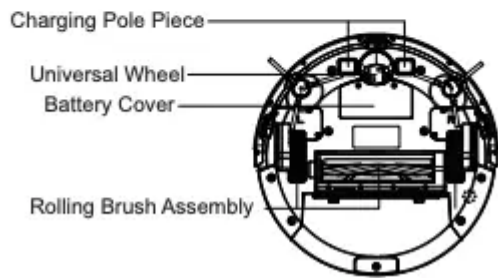
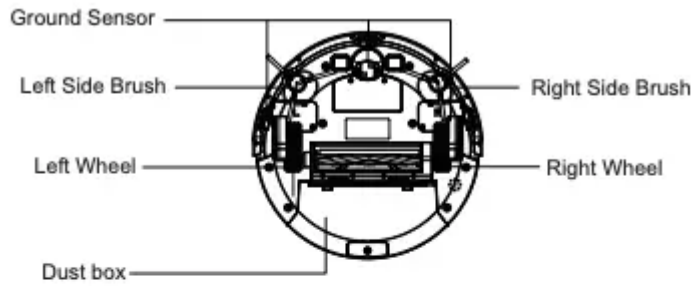

Dust box

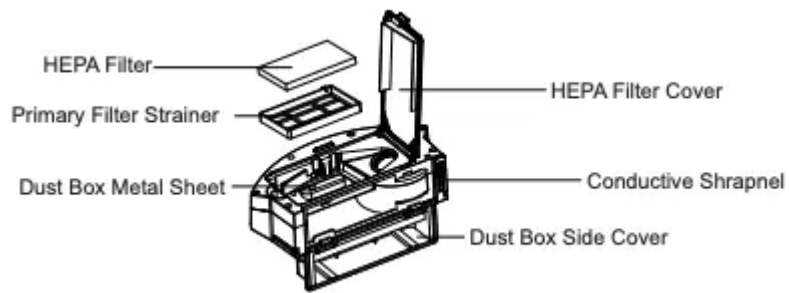

Water Tank and Mop Assembly

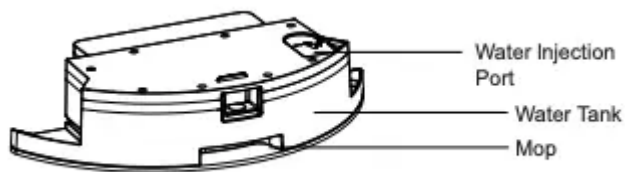

Charging Station

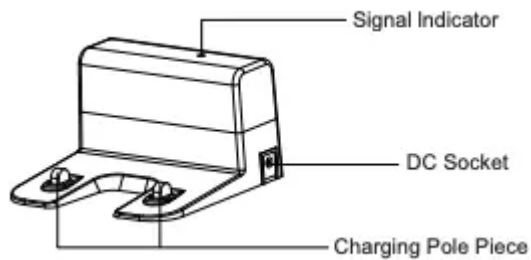

Remote Control



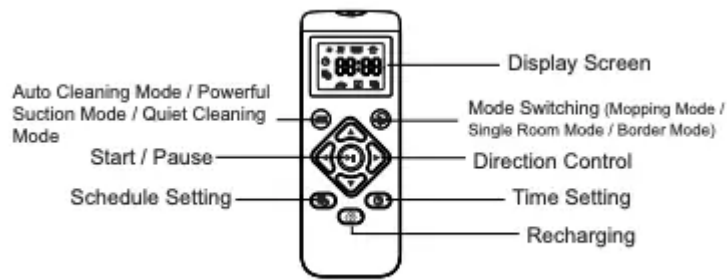

## Product Usage / Preparation

### Remove Protection

Before using the host, remove the protective strip on the host and the protective film on the charging station.

#### Remove the protective strip

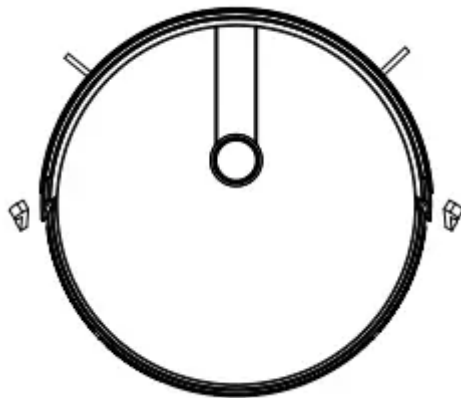

#### Remove protective film

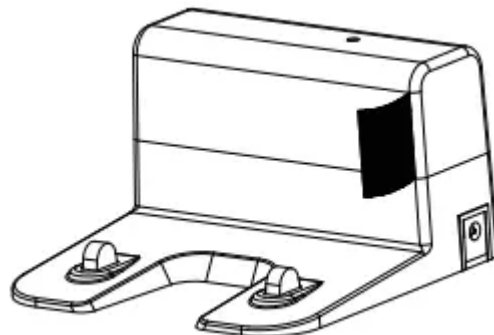

## Product Use / Host Charging

1. Placing and charging: The charging station is against the wall and placed on a flat ground. Do not place articles within the range of 0.5m left and right and 1.5m ahead.

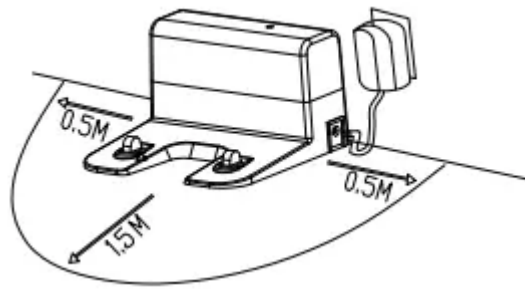

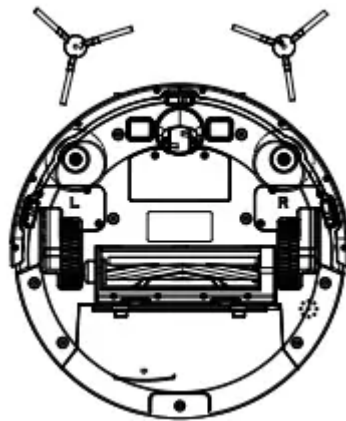

2. Connect the power supply

3. Installing side brush: Install the side brush according to the left and right (L/R).



### ⓘ Charging attention:

1. **Charging:** Place the host on the charging station for charging. (During charging, the indicator light  flashes; If charging is over, the light  is always on. The charging time is about 5 hours.

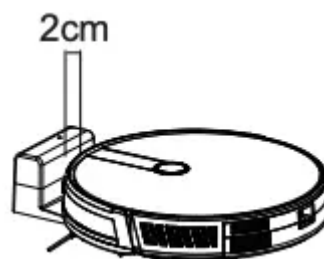

**Attention :** When manual charging, please keep the front bumper of the robot 2cm away from the charging station to ensure the metal contacts connected well for a successful charging.

2. The charging station cannot be used in environments with strong reflection such as direct sunlight or nearby mirrors. If there is any object with strong reflection, please cover it 7cm from the bottom.

3. In order to ensure the normal working hours of the host, please fully charge it before use. The charging time is about hours.

4. When charging, do not assemble the water tank assembly to the robot vacuum, so as to ensure the safety of charging and prevent wet mops from damaging the floor.





5. During the cleaning process, the host can sense that its power is insufficient and automatically start the recharging mode to find the charging station to recharge. You can





also command the host to start the recharging mode through the recharging button  on the remote controller.

## Product Use / Start Cleaning

According to different cleaning needs, the product has a variety of cleaning modes to choose from. You can start various cleaning modes through a host, remote control or app.

### Automatic Cleaning





Setting method: In the shutdown state, press the button  for a few seconds. When the indicator light  of the host is on, it indicates that the host is powered on. When the button  on the host is pressed for a short time, or press the automatic cleaning button  on the remote controller, the host starts automatic cleaning.



If it is dustbin instead of water tank installed in the host, and in standby mode or other working modes, press the button  on the remote controller, the host starts automatic cleaning. Press the button  again, the host will switch to powerful suction mode. Press the button  once more, the host will switch to quiet cleaning mode. Pressing the button  additionally more times will make the host switch between powerful suction mode and quiet cleaning mode circularly. If it is water tank installed in the host, and in standby or other working modes, pressing the button  will always make the host enter into mopping mode.







### Mopping Mode

**Applicable scenario:** Used to do wet & dry mopping.



**Setting method:** Install the water tank to the host and press the start button  on the host or the button  or  (  ) on the remote controller, the host starts mopping mode.

(**Attention:** If the water tank is not installed, press the button  (  ) on the remote controller, the host will prompt that the water tank is not installed and the host will not work at this status.)

Press the button  (  ), the host will switch to single room cleaning mode. Press the button  (  ), the host will switch to border cleaning mode.

## Single Room Cleaning

**Applicable scenario:** Used to clean the single room.



**Setting method:** Click the remote control mode switch button  (  ) to select the single room cleaning mode to start the single room cleaning.

**Friendly Reminder:** When it is only necessary to clean a single room, please close the door and the host will do centralized cleaning in the room.

If this room does not have a charging station, the host will return to the original point after finishing cleaning.

## Border Sweeping

**Applicable scenario:** For indoor border cleaning, the host cleans along the perimeter of fixed objects (such as walls), and returns to the charging station after the border cleaning finished.



**Setting method:** Click the remote control mode switch button  (  ) to select the border cleaning mode to start the border cleaning.

## Manual Control



**Applicable scenario:** Suitable for manual control cleaning.

**Setting method:** Click on the buttons  on the remote controller to move forward and backward and turn right or left.

## Product use / pause, wake up and shut down





**Pause:** During the operation of the host, press the host button  or the pause button  on the remote controller or app to pause the host.

**Wake up:** If the host stops working for more than ten minutes, it will automatically enter into sleep mode (all the host lights are off). You can wake up the host by pressing the host button

 or any button on the remote controller, or the button  on app.



**Shut down:** After the host stops working, press the host button  for a few seconds and all the indicator lights of the host go out to indicate that the host has been shut down.

## Product Usage / Schedule Settings

**Schedule setting:** Press the remote control schedule setting button  to set the host scheduled cleaning time. First press the button , then press the buttons  to set the hour and minute. After it, press the button , then the setting is completed.

The host will automatically start to clean at the scheduled time every day.

**PS:** Before the schedule setting, you need to press the button to set the current time of the host

first. Press the button , then press the buttons  to set the hour and minute of the current time. After it, press the button , then the setting is completed.

## Product Use / Water Tank Use

Do not use the floor mopping function on carpets. After mopping the floor, please empty the water tank in time and remove the mop.

Add water

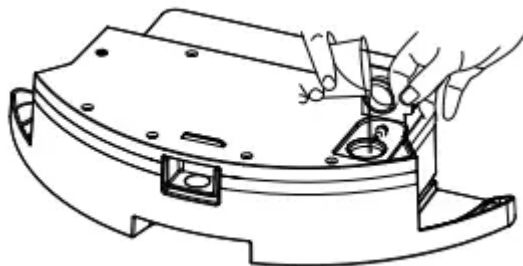

Install Mop

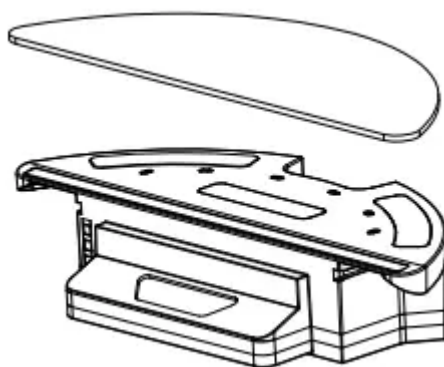

Install the Water Tank Assembly

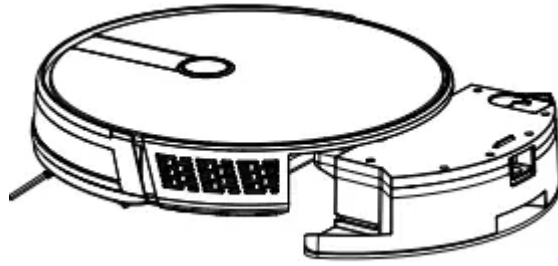

Start Mopping the Floor



**Component maintenance / dust box**

A . Press the dust box button to take out the dust box;

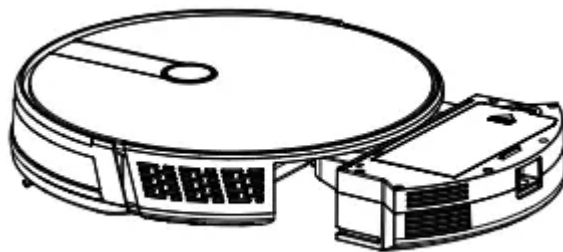

B . Open the dust box side cover;

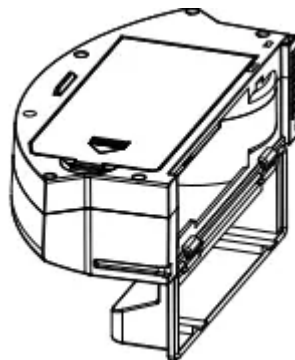

C. Dumping the rubbish.

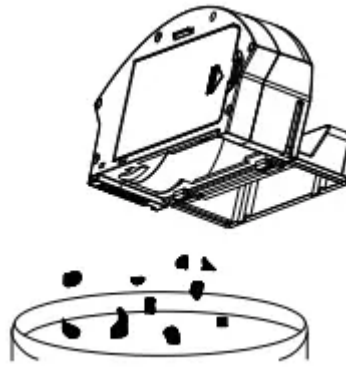

D. Open the HEPA Filter cover;

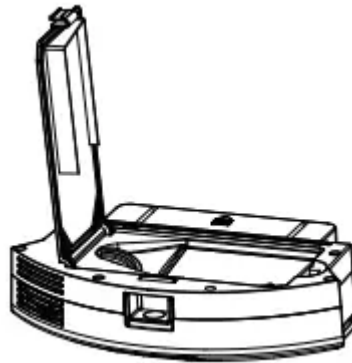

E. . Open the HEPA filter cover and take out the HEPA filter and the primary filter. It is not recommended to wash the HEPA filter by water. Tap gently to remove the dust;



F. . Rinse the primary filter;



G . The dust box should be scrubbed with mop;

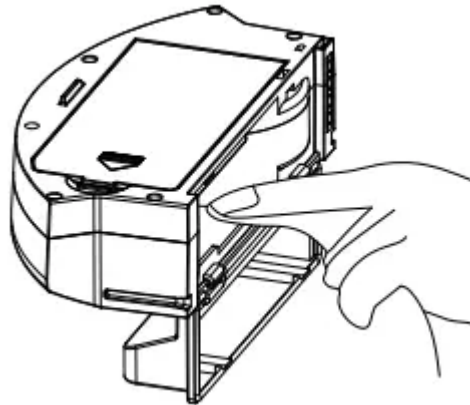

H . Dry the dust box and filter assembly and keep it dry to ensure its service life;

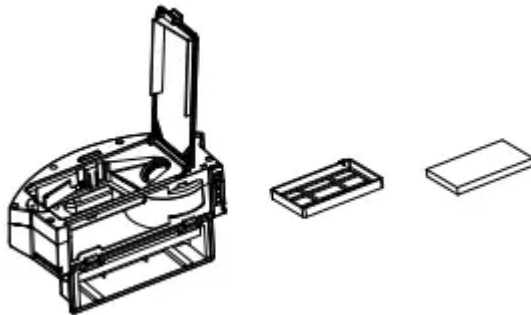

I. Replace the primary filter and the HEPA filter into the dust box;

**Note:**

- 1. Before installing the filters, please ensure that the HEPA filter and the primary filter are in dry state.
- 2. Do not expose the HEPA filter and primary filter to the sun.

J. Close the dust box cover and install the dust box into the host.

**ⓘ Note: Do not allow water to seep into the fan port when cleaning.**

## Component maintenance / water tank and mop

1.Take out the water tank assembly;

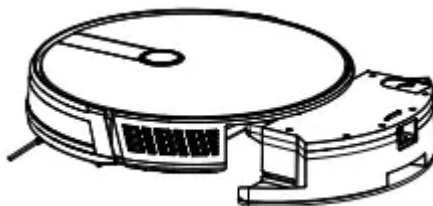

2.Remove the mop;

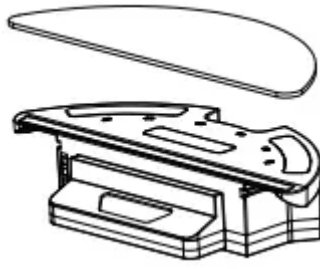

3.Empty the Water Tank;

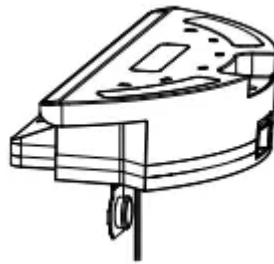

4.Washing mop;



5. Airing;



6. Dry or naturally dry the water tank.

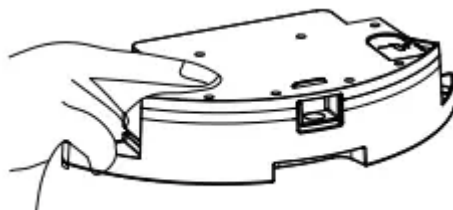

## How to clean the rubbish in the dustbin of the water tank

1. Put the water tank horizontally with the dustbin port upside.

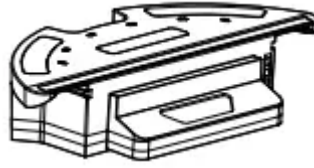

2. Clean up the rubbish in the dustbin of the water tank with running water.

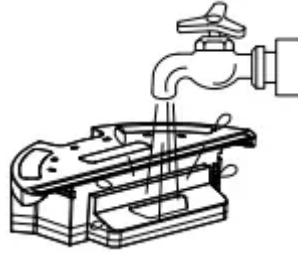

3. Dry up the conductive shrapnel

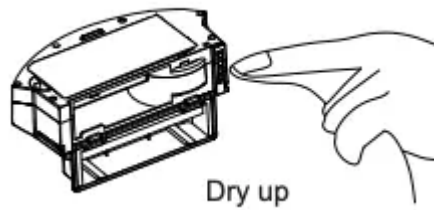

## Component maintenance / roller brush and side brush

- 1 . Open the roller brush cover assembly;



2. Take out the roller brush shaft;

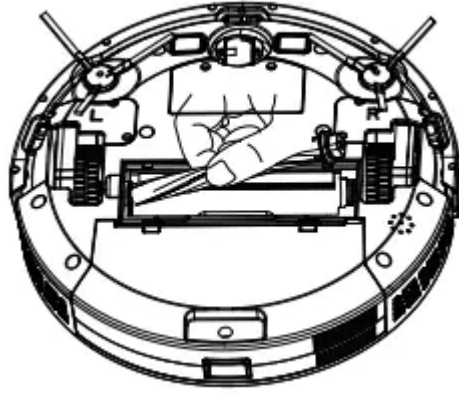

3. Use the cleaning brush to cut off the hair tangled on the roller brush;

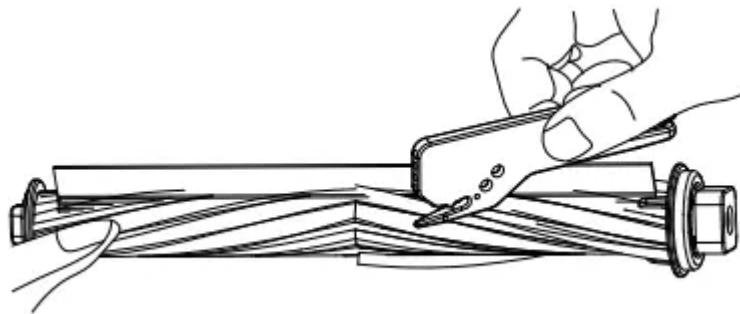

4. Clean the side brush.

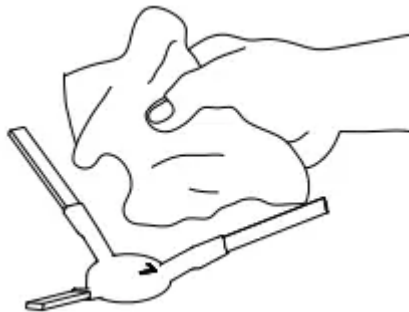

## Component maintenance / charging pole pieces, ground sensors, drive wheels and universal wheel

**Friendly Reminder:** The interior of the charging pole pieces, the ground sensors and the front bumper all contain sensitive electronic components. Please use dry mop to clean the above parts and do not use wet mop to prevent damage caused by water inflow.

Clean the charging pole pieces.

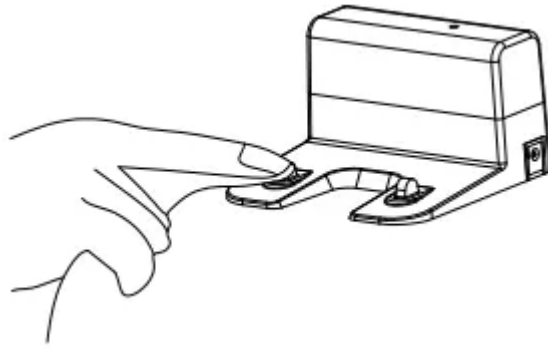

Clean the ground sensors.

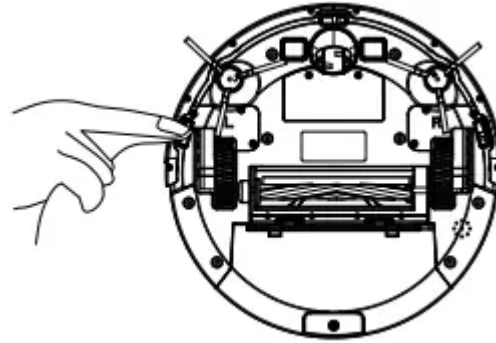

Clean the drive wheels and the universal wheel.

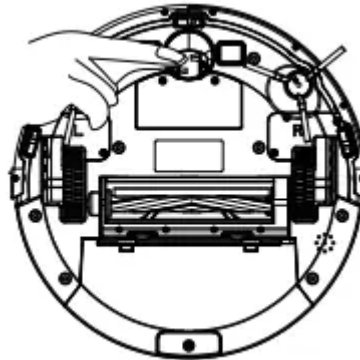

If you do not use the product for a long time, please fully charge it before storing. Turn off the host and keep charging power to it every 3 months to prevent the battery from over discharge. If the battery is over discharged or is not used for a long time, the product may not be able to be charged. Please contact our company for after-sales maintenance. Do not disassemble it by yourself.

## Investigation of common problems

### Wheels off the ground.

Host suspended.

- Please put the host back to the ground and press the cleaning key again.

### Dust box not installed.

Dust box removed and not installed.

- Replace the dustbin to the host and press the cleaning button again.

**Battery failure.**

Abnormal battery charging.

- Contact after-sales service to test the battery.

**Please check if the wheel is stuck.**

Wheel jammed.

- Check whether the wheel is entangled with foreign objects and clean up the entangled objects.

**Please check if the front bumper is stuck.**

Front bumper bracket stuck.

- Check whether the front bumper can be bounced normally.

**Robot connection failed.**

Machine failed to connect to server.

- Check whether the wireless network connected during distribution can connect to the internet.

**The battery is low, please charge the machine.**

Battery power less than 20%.

- The host automatically switches to recharging mode.

**Please check whether the side brush is tangled or jammed.**

Abnormal side brush.

- Check whether the side brush is twined by wire or hair and clean up the wire or hair.

**Please move the machine to the open area.**

The machine failed to get out of trouble.

- Please move the host to an empty place and press the cleaning key again.

**Warning**

This content is compiled from multiple sources and is provided for reference purposes only. It may not be complete or fully applicable to all situations. If you are unable to resolve your issue, please contact the product manufacturer or an authorized service provider for official support.



