

## Positioning and connecting

Included with the appliance

Note: Check the machine for transport damage. Never use a damaged machine. If you have any complaints, contact the dealer from whom you purchased the appliance or our customer services.

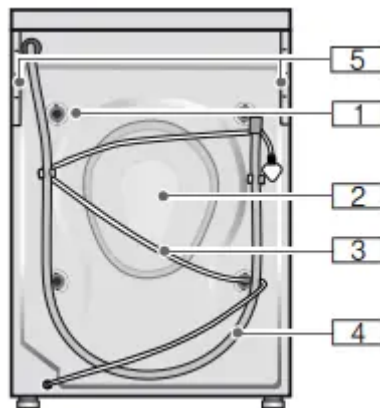

- 1 Transport bolts
- 2 Rear cover
- 3 Mains cable
- 4 Water drain hose
- 5 Support Struts, you can remove them by yourself as required.

The appliance also contains:

- Supplementary sheet for the operating and installation instructions
- After-sales service location directory\*
- Warranty\*
- Cover caps for openings after the transport bolts have been removed
- Bottom cover. Please install it correctly before using the appliance\*
- Water supply hose
- Elbow for securing the water drain hose\*

\* depending on the model

In addition, a hose clamp (24 - 40 mm diameter, available from specialist dealers) is required to connect the water drain hose to a siphon.

## Useful tools

- Spirit level for aligning
- Spanner for loosening the transport bolts and for aligning the appliance feet

## Removing the transport bolts

Note: To avoid injury, take care when handling these.

1. Use a spanner to loosen all fixing bolts until they turn freely.
2. All four parts will fall to the floor when you tip the machine.



3. Insert the cover caps which you will find in the bag containing the documentation.



## Water outlet

### Caution!

### Water damage

If the drain hose slips out of the wash basin or the connection point during draining due to high water pressure, any escaping water may cause water damage. Secure the drain hose so that it cannot slip out.

Note: Do not kink the water drain hose or put strain on it lengthways.

You can lay the water drain hose as follows:

### Caution! Damage to the appliance/fabrics

If the end of the drain hose is immersed in the drained water, water may be sucked back into the appliance and may damage the appliance/fabrics.

Make sure that:

- The plug does not block drainage from the sink.
- The end of the drain hose is not immersed in the drained water.
- The water drains away quickly enough.

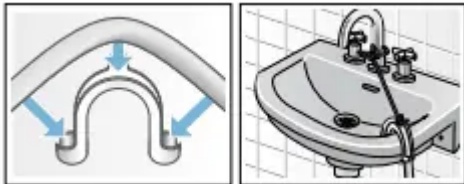

### Drainage into a siphon

The connection point must be secured using a hose clamp with a diameter of 24-40 mm (available from specialist dealers).

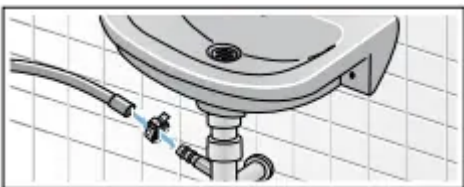

### Outlet into a plastic pipe with rubber bushing or into a drainage pit



### Levelling

Level the appliance using a spirit level. Incorrect levelling may result in intense noise, vibrations and "wandering".

1. Loosen the lock nuts using a wrench, by turning it in a clockwise direction.
2. Check the alignment of the washing machine with a spirit level, and adjust it if necessary. Change the height by turning the appliance feet. All four appliance feet must stand firmly on the ground.
3. Tighten the lock nut against the housing. In doing so, hold the foot tight and do not adjust its height. The lock nuts on all four appliance feet must be screwed tightly against the housing.



## Getting to know the appliance

### Washing machine

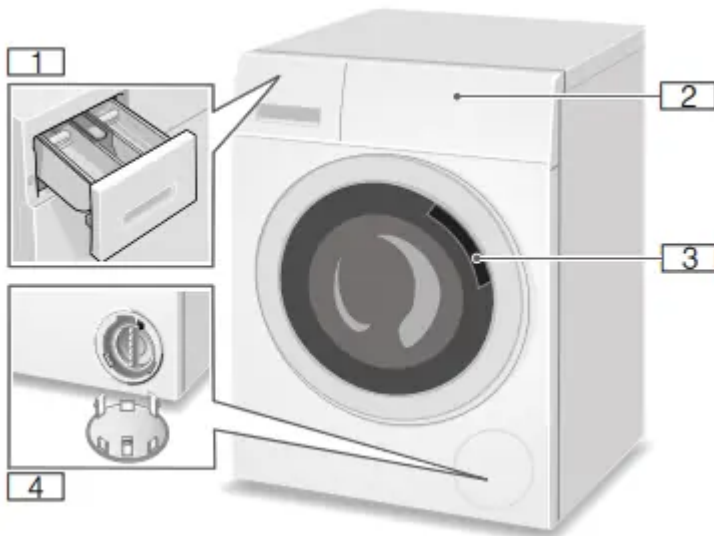

- 1 Detergent drawer
- 2 Operating/display panel
- 3 Loading door with door handle
- 4 Service flap

### Control panel

Control panel differs depending on the model



- 1 Programmes -> Supplementary sheet for the operating and installation instructions.
- 2 Programme selector
- 3 Display panel for settings and information

## Display panel

Note: The tables show possible setting options and information in the display panel; these differ depending on the model.

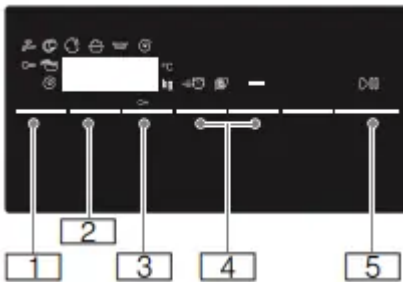

Button	Display in- dicator	Description
1	 --- 90 °C**	Selectable <b>Temp. °C</b> in °C; --- = cold
2	 --- 0 1 100**	Selectable <b>rpm</b> Ⓞ in rpm: 0 = no spin cycle, draining only; --- = Rinse Stop
3	 e.g. 2:30  1-24 h	<b>Finished in</b> ☹ Program duration depends on the program selection in h:min (hours:minutes) End of programme ("Fin- ished in" time) after ...h (hours)
4		<b>Additional program                      settings:</b> → Page 23



\* depending on the model  
 \*\* depending on the selected program, settings and model

Button	Display in- dicator	Description
		Speed Eco
		Rinse Plus *
5		<b>Button</b> for starting a pro- gram, Interrupting a pro- gram, e.g. to add items of laundry and cancelling a program

\* depending on the model  
 \*\* depending on the selected program, settings and model

## More information on the display panel

Display indicator	Description
7.5 kg**	<b>Load recommendation</b>
	<b>Program progress:</b>
	Washing
	Rinsing
	Spinning
<b>End</b>	Programme end
- - -	Programme end during Rinse Stop
	<b>Washing machine door</b>
	→ "Adding/removing laundry" on page 27
	→ "Faults and what to do about them" on page 33
	<b>Tap</b>
	→ "Faults and what to do about them" on page 33
	<b>Childproof lock</b>
	→ "Childproof lock" on page 26
	→ "Faults and what to do about them" on page 33
* depending on the model	
** depending on the selected program, settings and model	

Display indicator	Description
	<b>Foam detection*</b>
	→ "Starting the programme" on page 26
	→ "Information on the display panel" on page 34
	<b>Indicator lamp for Drum clean programme*</b>
	→ "Information on the display panel" on page 34
	→ "Appliance settings" on page 28
<b>E: - -</b>	<b>Fault display</b>
	→ "Information on the display panel" on page 34
<b>0 - 4</b>	<b>Signal setting</b>
	→ "Appliance settings" on page 28
* depending on the model	
** depending on the selected program, settings and model	

**Note:** Energy saving mode In order to save energy, the appliance switches to energy saving mode. The display lighting goes out after a few minutes and the  button flashes. To activate the lighting, press any button. The energy saving mode is not activated if a programme is running.

## Laundry

### Preparing the laundry

Therefore, note the following tips when preparing your laundry:

- Empty any pockets.



- Check for metal items (paper clips, etc.) and remove them.
- Wash delicates in a laundry bag (tights, underwired bras, etc.).



- Remove curtain fittings or place curtains in a laundry bag.
- Close any zips, button up any cover buttons.
- Brush sand out of pockets and collars.

## Soaking

1. Pour soaking agent/detergent into compartment **II** in accordance with the manufacturer's instructions.
2. Select the desired programme.
3. Press the **▶|||** button to start the programme.
4. After approx. ten minutes, press the **▶|||** button to pause the programme.
5. After the desired soaking time, press the **▶|||** button again to continue or change the programme.

## Notes

- Load laundry of the same colour.
- No additional detergent is required; the soaking solution is used for washing.

## Detergent

### Correct selection of detergent

The care label is crucial to ensure correct detergent selection, temperature and laundry treatment.

- Standard detergent with optical brighteners suitable for heat-resistant white washing made from linen or cotton

Programme: Cottons / cold – max. 90 °C

- Detergent for colours without bleach or optical brighteners suitable for coloured washing made from linen or cotton

Programme: Cottons / cold – max. 60 °C

- Detergent for colours/delicates without optical brighteners suitable for coloured laundry made from easy-care fibres, synthetic fibres

Programme: Easy-Care / cold – max. 60 °C

- Detergent for delicates suitable for delicate, fine fabrics, silk or viscose

Programme: Delicates/Silk / cold – max. 40 °C

- Detergent for woollens suitable for woollen fabrics

Programme: Wool / cold – max. 40 °C

## Saving energy and detergent

For light and normal soiling, you can save energy (lower washing temperature) and detergent.

Saving	Soiling/note
Reduced temperature and detergent quantity as per the recommended dosage	<b>Light</b> No visible dirt or stains. Clothing has taken on some body odour, e.g.: <ul style="list-style-type: none"><li>■ Light summer/sports clothing (worn for a few hours)</li><li>■ T-shirts, shirts, blouses (worn for up to one day)</li><li>■ Guest bed linen and hand towels (used for one day)</li></ul>
	<b>Normal</b> Visible dirt or a few light stains, e.g.: <ul style="list-style-type: none"><li>■ T-shirts, shirts, blouses (sweat soaked, worn a few times)</li><li>■ Towels, bedding (used for up to one week)</li></ul>
	Temperature as per the care label and detergent quantity as per the recommended dosage for heavy soiling

**Note:** When measuring the amount of all detergents/additives/care products and cleaning agents, please always check the manufacturer's instructions and information. -> "Measure and add detergent and care products" on page 25

## Programme default settings

The programme default settings for all programmes are preset at the factory and are displayed in the display panel after the programme is selected.

You can change the default settings by repeatedly pressing the corresponding buttons until the required settings are displayed in the display panel.

Note: Pressing and holding the button automatically runs through the setting values until the last one. Press the button once more and you will be able to change the setting values again.

The available settings vary depending on the model.

You can find an overview of all settings available for selection in each programme on the supplementary sheet for the operating and installation instructions.

### Temp. °C

Depending on what stage the programme is in, you can change the set temperature before and at the beginning of the programme.

#### Notes

- The maximum temperature that can be set depends on the programme that has been selected.
- The remaining time may be increased or decreased according to the changed temperature values.

### rpm

Depending on what stage the programme is in, you can change the spin speed (in rpm; revolutions per minute) before and during the programme.

Setting 0: The rinsing water is drained but there is no final spin. The laundry stays wet inside the drum, e.g. for items that should not be spun.

Setting - -: (Rinse Stop) = no final spin. The laundry stays in the water after the final rinse.



You can select "Rinse Stop" to prevent creasing if the laundry will not be taken out of the washing machine immediately after the program has ended. To continue/end the program see -> Page 27

Note: The maximum speed that can be set depends on the model and programme that has been selected.



### Finished in

Before starting the programme, you can preselect the programme end ("Finished in" time) in hourly increments (h = hour) up to a maximum of 24 hours.

To do this:

1. Select a programme. The programme duration is displayed for the selected programme, e.g. **2:30** (hours:minutes).
2. Press the Finished in  button repeatedly until the required number of hours is displayed.
3. Press the  button. The door will be locked. The selected number of hours (e.g. **8 h**) is shown in the display panel and counts down until the wash programme starts. The duration of the programme is then displayed. Note: The programme duration is included in the selected "Finished in" time.

During the timer count-down, you can change the preselected number of hours as follows:

1. Press the  button.
2. Use the Finished in  button to change the number of hours.
3. Press the  button.

During the timer count-down you can add or remove laundry as required.

Note: The length of the programme is automatically adjusted when the programme is running.

Certain factors can affect the programme length, e.g.:

- Programme settings,
- Detergent dosage (additional rinse cycles if required due to foaming),
- Load size/type of textiles (longer washing for higher load and for textiles which absorb more water),
- Imbalances (e. g. due to fitted sheets) are offset with several startups of spin cycles,
- Fluctuations in power supply,
- Water pressure (infeeding speed).

## Operating the appliance

### Preparing the washing machine

1. Connect the mains plug.
2. Turn on the water tap.
3. Open the door.
4. Check that the drum is completely drained. Drain if necessary.



### Select programme/switch on the appliance

**Note:** If you have activated the childproof lock, you must first deactivate it before you can set a programme. -> "Childproof lock" on page 26

Use the programme selector to select the required programme. The programme selector can be rotated in either direction.

The appliance is switched on.

The programme default settings for the selected programme appear in the display panel:

- The maximum load and the duration of the programme (alternately)

Note: The maximum load appears only when the door is opened.

### Change the programme default settings

You can use the default settings or change them.

To do this, repeatedly select the corresponding button until the required setting is displayed.

The settings are activated without needing to be confirmed.

They are not saved when the appliance is switched off. -> "Programme default settings" on page 21

Overview of programmes -> Supplementary sheet for the operating and installation instructions.

### Select additional programme settings

By selecting additional settings, you can better adapt the washing process to your items of laundry.

The settings can be selected or deselected depending on the programme progress.

The indicator lamp for the button lights up if a setting is active.

The settings are not saved when the appliance is switched off. -> "Additional programme settings" on page 23

Overview of programmes -> Supplementary sheet for the operating and installation instructions.

## Placing laundry into the drum

### Notes

- Mix items of laundry of varying sizes. Laundry items of different sizes distribute themselves better during the spin cycle. Individual items of laundry may lead to imbalances.
  - Observe the specified maximum load. Overfilling has a negative impact on the washing result and promotes creasing.
1. Place presorted items of laundry unfolded in the washing drum.
  2. Make sure that no items of laundry are trapped between the washing machine door and the rubber seal, and close the door.



The  button indicator lamp flashes to indicate that the washing programme can be started. It is possible to change the settings.



-> "Programme default settings" on page 21



-> "Additional programme settings" on page 23

## Childproof lock

(  3 sec.)

You can lock the washing machine to prevent the functions you have set from being changed inadvertently.

To activate/deactivate, press and hold the rpm  and Finished in  buttons at the same time for approx. three seconds. The  symbol appears in the display panel.



-  lights up: The childproof lock is active.
-  flashes: The childproof lock is active and the programme selector has been adjusted. If you reset the programme selector to the initial programme, the symbol lights up again.

### Notes

- If the appliance is switched off while the programme is running and childproof lock is activated, the programme continues when the appliance is switched back on.
- To remove the laundry at the end of the programme, deactivate the childproof lock.
- The childproof lock remains active, even once the washing machine has been switched off.

## Adding/removing laundry

After starting the programme, you can add or remove laundry as required.

Press the  button to pause the programme. The  button indicator lamp flashes and the machine checks whether it is possible to add or remove laundry.

- If the  symbol disappears in the display panel, the washing machine door is unlocked. You can add or remove laundry.

## Notes

- Do not leave the door open for too long when adding/removing laundry as water from the laundry may leak out.
- The load display is not active during reloading.



Press the  button to continue the programme.

If the  symbol lights up in the display panel, it is not possible to add or remove laundry.

**Note:** For safety reasons, the door remains locked when the water level or temperature is high, or while the drum is turning.



## Changing the programme

If you have started the wrong programme by mistake, you can change it as follows:



1. Press the  button.
2. Select another programme.
3. Press the  button. The new programme starts from the beginning.

## Cancelling the programme

For programmes at high temperature:

1. Press the  button.
2. To cool down laundry: Select Rinse.
3. Press the  button.

For programmes at low temperature:

1. Press the  button.
2. Select Spin.
3. Press the  button.

## Programme end during Rinse Stop

- - appears in the display panel and the indicator lamp of the  button flashes.

Continue the programme by:

- Pressing the ▶ button (the laundry will be spun with the default spin speed setting\*) or
- Selecting a spin speed or setting the programme selector to Spin and then pressing the ▶ button.

### Programme end

End appears in the display panel and the indicator lamp of the ▶ button is off.

### Removing laundry/switching off the appliance

1. Turn the program selector to off position. The appliance is switched off.
2. Turn off the tap. Disconnect the mains cable.
3. Open the door and remove the laundry.

### Notes

- Always wait until the program ends, as the appliance could still be locked.
- If the display panel goes off at the end of a program, the energy-saving mode is active. Press any button to activate the panel.
- Do not leave any items of laundry in the drum. They may shrink in the next wash or discolour another item.
- Remove any foreign objects from the drum and the rubber seal – risk of rusting.
- Wipe the rubber seal dry.



- Leave the door and detergent drawer open so that any residual water can evaporate.

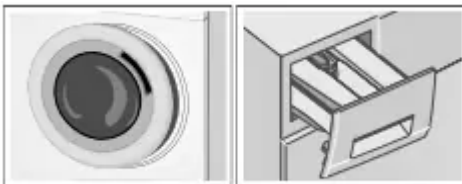

### Appliance settings

You can change the following settings:

- The volume of the information signals (e.g. at the end of the programme) and/or
- The volume of the button signals and/or
- Switch on or off the drum clean reminder\*.

In order to change these settings you will need to activate the setting mode.



1/2/3/4... positions on the programme selector



### Activating the setting mode

1. Turn the programme selector to position 1. The washing machine is switched on.
2. Press the  button and, at the same time, turn the programme selector clockwise to position 2. Release the button.

The setting mode is activated and the preset volume for the information signals appears in the display panel (e.g. at the end of the programme).

\* depending on the model

### Changing the volume

- To change the volume of the information signals, use the Finished in  button while the programme selector remains at position 2.
- To change the volume of the button signals, rotate the programme selector to position 3. Use the Finished in  button again to change the volume.

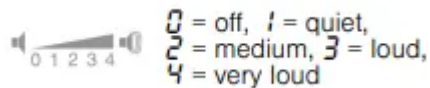

Switching on or off the drum clean reminder\*

To switch on/off the drum clean reminder, rotate the programme selector to position 4. Use the Finished in  button to switch the reminder on or off.



If the setting is activated, an acoustic signal is heard.

### Exiting setting mode

You can now end the process and set the programme selector to the off position. The settings are saved.

# Cleaning and maintenance

## Machine housing/control panel

- Wipe the housing and the control panel with a soft, damp cloth.
- Remove the detergent residue immediately.
- Do not clean with a water jet.

## Drum

- Use chlorine-free cleaning agents, do not use steel wool.
- If there are odours in the washing machine, or to clean the drum, run the Drum clean programme or Cottons 90 °C programme\* without laundry.

## Descaling

- Descaling should not be necessary if the detergent is measured out correctly. However, if it is required, follow the manufacturer's instructions for the descaling agent. Suitable descalers can be obtained via our website or from our after-sales service. -> Page 37

## Detergent drawer and housing

If the detergent drawer contains detergent or fabric softener residues:

1. Pull out the detergent drawer. Press down the insert and fully remove the drawer.
2. To remove the insert: Push the insert upwards from below with your finger.

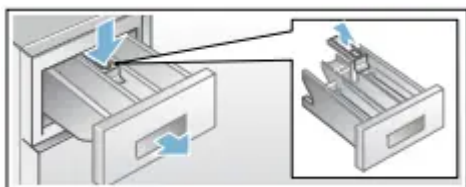

3. Clean the detergent dispenser tray and insert with water and a brush, and dry it. Clean the inside of the housing as well.
4. Fit the insert and lock it in place (push the cylinder onto the guide pin).
5. Push in the detergent drawer.

Note: Leave the detergent drawer open so that any residual water can evaporate.

## Cleaning the measuring aid A\* for liquid detergent

If it contains liquid detergent residue:

1. Hold the measuring aid, pull the cover upward and disconnect them.

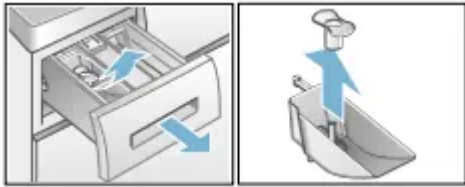

2. Clean the measuring aid and cover with water and brush.

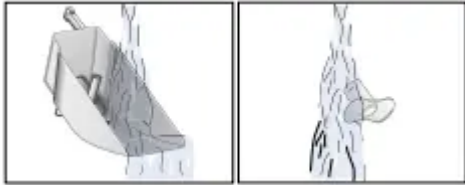

3. Install the cover back to the measuring aid. Pay attention to the assemble mark, and press the cover until click sounds.

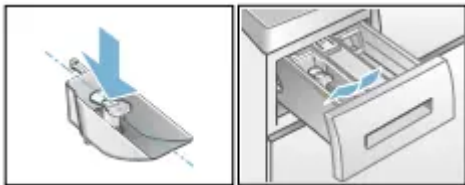

### Detergent solution pump blocked

Note: Turn the tap off to prevent more water from flowing in and to ensure that it is drained via the pump.

1. Pull out the mains plug.
2. Open and remove the maintenance cover.



3. Carefully unscrew the pump cover - do not remove it completely. Let the water drain into a shallow container. Repeat the operation until there is no water left.

4. Remove the pump cover. Remove foreign material/fluff from inside the pump. Clean the interior, pump cover thread and pump housing (the fan impeller in the detergent-solution pump must be able to rotate).

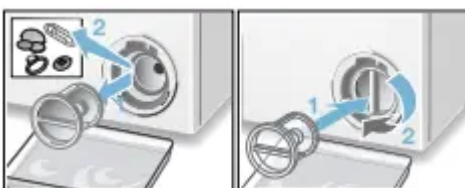

5. Refit the pump cover, ensuring it fits tightly. Handle should be vertical.

6. Insert the maintenance cover and close it.

Note: To prevent unused detergent from flowing into the outlet during the next wash: Pour 1 litre of water into dispenser II and start the Spin programme.

### The drain hose at the siphon is blocked

1. Switch off the appliance. Disconnect the mains plug.
2. Loosen the hose clamp. Carefully remove the drain hose; residual water may leak out.
3. Clean the drain hose and siphon connecting piece.



4. Reattach the drain hose and secure the connection using the hose clamp.

## Information on the display panel

### lights up

- The temperature is too high. Wait until the temperature drops.
- The water level is too high. It is not possible to add laundry. Run the Spin programme to reduce the water level, if necessary.

### flashes

- Laundry may be caught. Open and close the door again and press the A button.
- If necessary, push the door closed or remove some laundry and then push it closed again.
- If necessary, switch the appliance off and on again; set the programme and make your individual settings; start the programme.

### lights up

- The water pressure is too low.

### flashes

- Turn on the cold water tap fully,
- Supply hose kinked/trapped,
- Clean the filter. -> Page 32

### E17

- The filters in the water connection is blocked. Clean the filter. ~ Page 32

- Fully turn on the tap and approximately 2.5 gallons (10 liters) of water per minute must flow out of the fully open tap. Contact your plumber if the water pressure is too low.

E18

- The drain pump is blocked. Clean the drain pump. -> Page 31
- The drain hose/drain pipe is blocked. Clean the drain hose at the siphon. ~-> Page 32

E32

- Alternating display with **End** when programme is finished, indicating the laundry inside are unbalanced. The washing machines' unbalanced load detection system can not adjust the imbalance. To protect the mechanical systems, the machine will not achieve the highest spin speed, and the laundry can not be spinned completely. Please wash small and large items of laundry together.



- The childproof lock is activated – deactivate it.



\* lights up

- Too much foam has been detected and an additional wash cycle has been activated. Add less detergent to the next washing cycle with the same load.

The indicator light  for the Drum clean programme\* flashes

Run the Drum clean programme or a 60 °C programme to clean and care for the drum and the outer tub.

### Notes

- Run the programme without laundry.
- Switching the information signal on/off -> Page 28

Other displays

- Switch off the appliance, wait for five seconds and then switch it on again. If the display appears again, call the after-sales service. -> Page 37

## Faults and what to do about them

Water is leaking from the appliance.

- Attach the drain hose correctly or replace it.
- Tighten the screw connection of the supply hose.

The machine is not filling with water. Detergent is not being dispensed.



- Have you pressed the  button?
- Is the tap turned on?

- Could the filter be clogged? Clean the filter. -> Page 32
- Is the supply hose kinked or trapped?
- Is there water in the drum?

The door cannot be opened.

- The programme does not end normally. Select any programme.
- Is - - - selected (Rinse Stop = no final spin)?
- Can the door only be opened by the emergency release? -> Page 33

The program will not start.

- Have you pressed the  or Finished in  button?
- Is the door closed correctly?
- Is the  childproof lock activated? Deactivate.

**The additional function could not be activated for the selected programme.**

- Can the additional option be selected?
- Overview of programmes -> Supplementary sheet for the operating and installation instructions.

The water is not draining.

- Is - - - selected (Rinse Stop = no final spin)?
- Clean the drain pump. -> Page 31
- Clean the drain pipe and/or the drain hose. -> Page 32

Water is not visible in the drum.

- Not a fault – the water is below the visible area.

The spin result is not satisfactory.

- Not a fault – the unbalanced load detection system has interrupted the spin cycle because the laundry is unevenly distributed.
- Distribute small and large items of laundry evenly in the drum.

Laundry is wet/too damp.

- Less Ironing \* selected?
- Is the selected speed too low?

The spin cycle runs several times.

- Not a fault – the unbalanced load detection system is adjusting an imbalance.

The programme duration changes during the wash cycle.

- Not a fault – the unbalanced load detection system is adjusting an imbalance by repeatedly distributing the laundry.
- Not a fault – the foam detection system is active – a rinse cycle has been switched on.

Residual water in the compartment .

- Remove the insert. Clean detergent drawer and re-insert -> Page 30

Residual detergent in the detergent dispenser

- Detergent is damp or lumpy, clean the detergent dispenser.
- Use the dosing aid for liquid detergent.

The  symbol lights up in the display panel. Foam may also be leaking from the detergent drawer.

- Have you used too much detergent?
- Mix one tablespoon of fabric softener with 1/2 litre of water and pour it into compartment II (not suitable for outdoor clothing, sportswear or items stuffed with down).
- Use less detergent in the next wash cycle.

Loud noises, vibrations and machine "movement" during the spin cycle.

- Is the appliance aligned? Align the appliance. -> Page 14
- Have the transport bolts been removed? Remove the transport bolts.-> Page 11

The display panel/indicator lights do not work while the appliance is running.

- Has there been a power failure?
- Have the fuses blown? Reset/replace the fuses.
- If the fault occurs repeatedly, call customer services. -> Page 37

**There is detergent residue on the laundry.**

- Some phosphate-free detergents contain water-insoluble residue.
- Select Rinse or brush the laundry after washing.

If you cannot rectify a fault yourself (after switching the machine off and on again) or a repair is required:

- Switch off the appliance and pull out the mains plug.
- Turn off the tap and call customer services. -> Page 37

**Warning**

This content is compiled from multiple sources and is provided for reference purposes only. It may not be complete or fully applicable to all situations. If you are unable to resolve your issue, please contact the product manufacturer or an authorized service provider for official support.

---

Document generated by [ManualsFile](#)

