

## PRODUCT OVERVIEW

### Parts

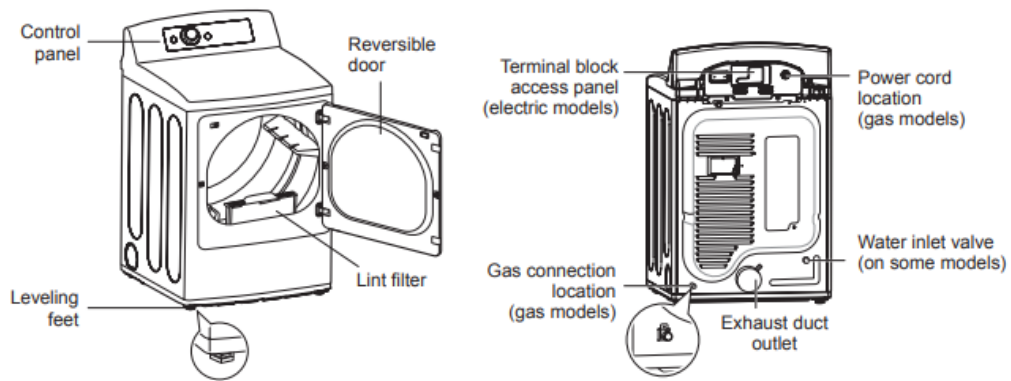

### Accessories

#### Included Accessories

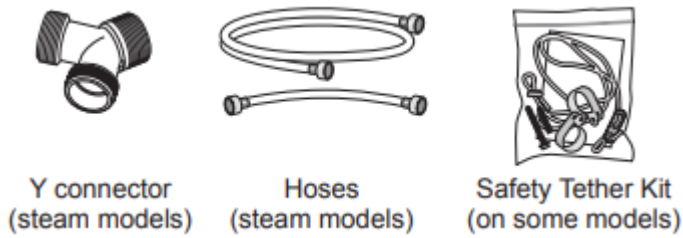

#### Optional accessories

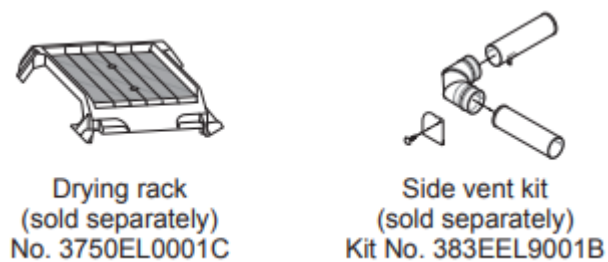

## Two-Way Reversible Door (on some models)

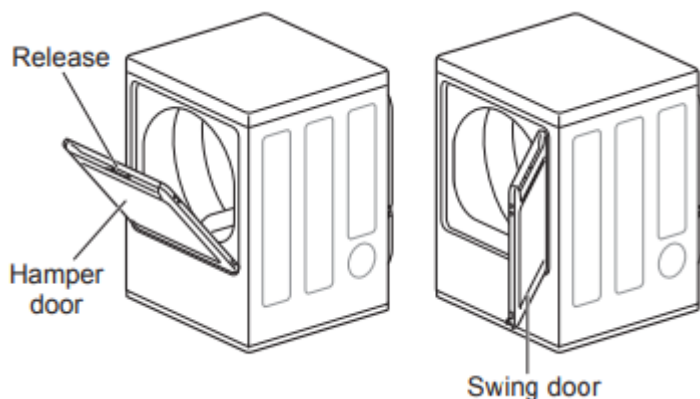

The LG EasyLoad™ feature allows you to open the dryer door from the top, hamper-style, when loading the dryer to help guide clothes into the drum and prevent them from falling onto the floor. When unloading the dryer or loading bulkier items, use the swing door for easy access to the drum.

## OPERATION

### Using the Dryer



#### 1 Clean the Lint Filter

If the lint filter has not already been cleaned, lift out the filter and remove the lint from the last load. This will help ensure the fastest and most efficient drying performance. Make sure to reinstall the filter, pressing down until it clicks firmly into place. The dryer will not operate without the lint filter in place.



#### 2 Load the Dryer

Load the dryer with the wet laundry from the washer. If the load is extra large, you may need to divide it into smaller loads for proper performance and fabric care.



### 3 Turn on The Dryer

Press the POWER button to turn ON the dryer. The cycle LEDs will illuminate and a chime will sound.



### 4 Select a Cycle

Turn the cycle selector knob either direction until the LED for the desired cycle is on. The preset temperature, dry level, and option settings for that cycle will be shown. Refer to page 37. Default settings for the selected cycle can now be changed if desired. This can be done using the cycle modifier buttons as shown on page 37. Cycle options can be added using the option buttons as shown on page 38-41.

#### NOTE

Not all options or modifiers are available on all cycles. A different chime will sound and the LED will not come on if the selection is not allowed.



### 5 Begin the Cycle

Press the START/PAUSE button to begin the cycle. The cycle can be paused at any time either by opening the door or by pressing the START/PAUSE button.

If the cycle is not restarted within 4 minutes of being paused, the dryer will shut off and the settings will be lost.



### 6 End of Cycle

When the cycle is finished, the chime will sound. Immediately remove your clothing from the dryer to reduce wrinkling. If Wrinkle Care is selected, the dryer will tumble briefly every few minutes to help prevent wrinkles from setting in the clothes.

## Check the Lint Filter Before Every Load

Always make sure the lint filter is clean before starting a new load; a clogged lint filter will increase drying time. To clean, pull the lint filter straight up and roll any lint off the filter with your fingers. Do not rinse or wash the filter to remove lint. Push the lint filter firmly back into place. See Regular Cleaning for more information.

Always ensure the lint filter is properly installed before running the dryer. Running the dryer with a loose or missing lint filter will damage the dryer and articles in the dryer.

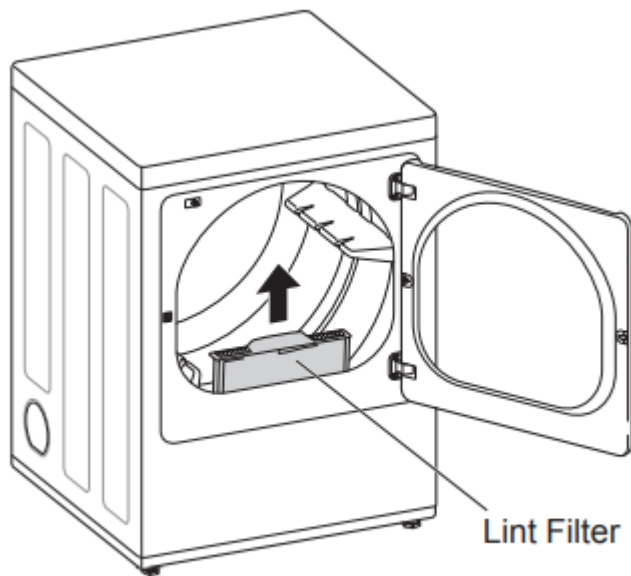

## Sorting Loads

### Fabric Care Labels

Most articles of clothing feature fabric care labels that include instructions for proper care.

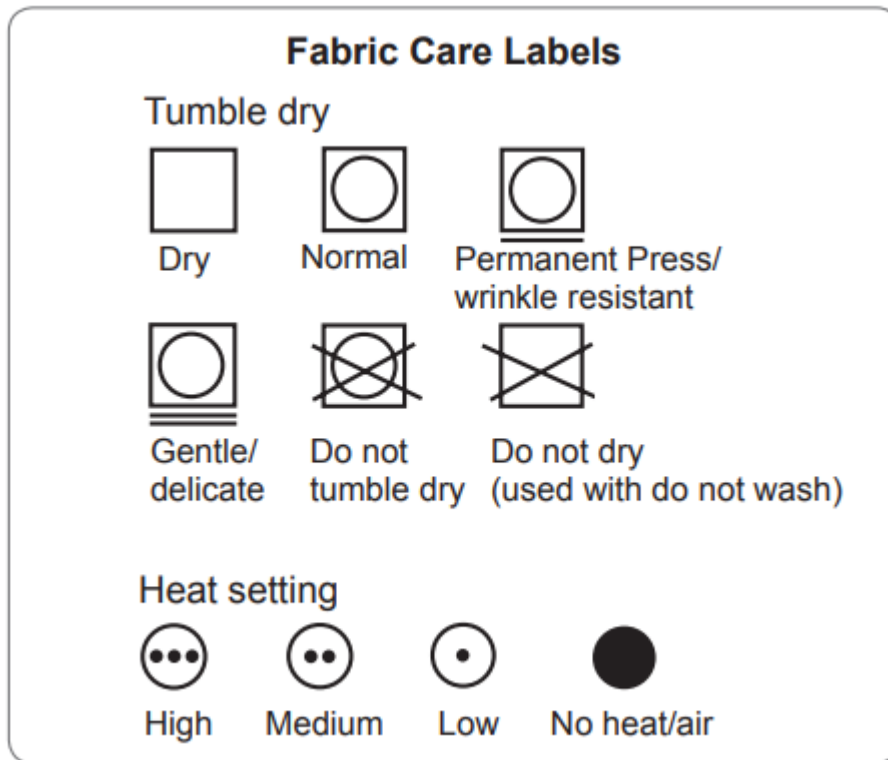

### Group Similar Items

For best results, sort clothes into loads that can be dried with the same drying cycle.

Different fabrics have different care requirements, and some fabrics will dry more quickly than others. For best fabric care results, always dry fabrics with similar care requirements together.

### Loading the Dryer

#### WARNING

To reduce the risk of fire, electric shock, or injury to persons when using this appliance, follow basic precautions, including the following:

- Check all pockets to make sure that they are empty. Items such as clips, pens, coins, and keys can damage both your dryer and your clothes. Flammable objects such as lighters or matches could ignite, causing a fire.

Failure to do so may result in fire, explosion, or death.

- Never dry clothes that have been exposed to oil, gasoline, or other flammable substances. Washing clothes will not completely remove oil residues. Failure to obey this warning may result in fire, explosion, or death.

#### NOTE

#### Loading Tips

- Combine large and small items in the same load.

- Damp clothes will expand as they dry. Do not overload the dryer; clothes require room to tumble and dry properly.
- Close zippers, hooks, and drawstrings to prevent these items from snagging or tangling on other clothes.

## Using the LG EasyLoad™

### Swing Door

Use the swing door when unloading, or when loading bulkier items, for easy access to the drum.

To open the swing door, grasp the top of the door on the side opposite the hinge and pull.

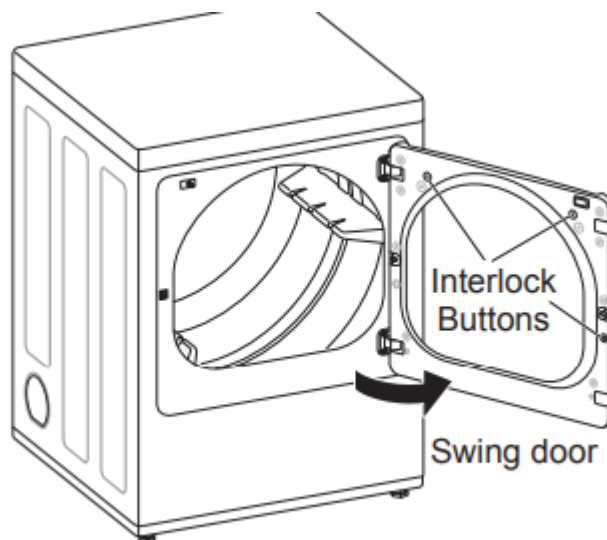

### WARNING

Do not press the three interlock buttons when the door is open. The door may fall off and cause serious injury.

- Do not place heavy items on or lean against the top of the door when it is open.

The dryer could tip forward, causing injury or property damage.

### Hamper Door (on some models)

Use the hamper door when loading. The hamper door opens about 40 degrees and acts as a chute to help guide items into the drum and help prevent items from falling onto the floor. It also comes in handy when unloading a few small items, helping prevent the rest of the laundry from being pulled onto the floor.

To open the hamper door, press the release on the top of the door and pull the door forward.

Make sure laundry is fully inserted in the drum before closing the door.

**NOTE** Make sure the swing door latch is completely closed before pressing the hamper door release.

## Hamper door release

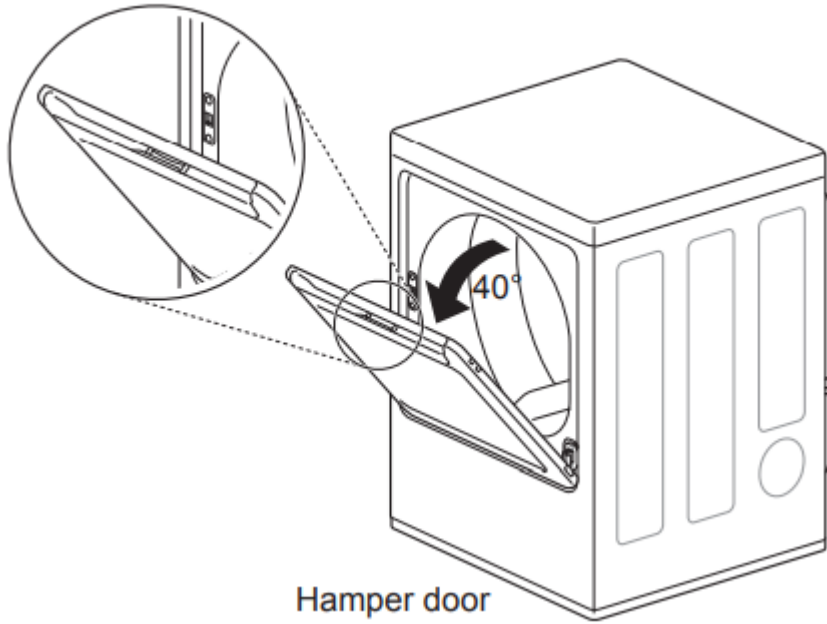

## Warning

- Do not attempt to pull the hamper door open more than 40 degrees.
- Be careful when opening and closing the door. Fingers and hands can get caught in the door and cause injury if the door drops forward unexpectedly.

## Control Panel

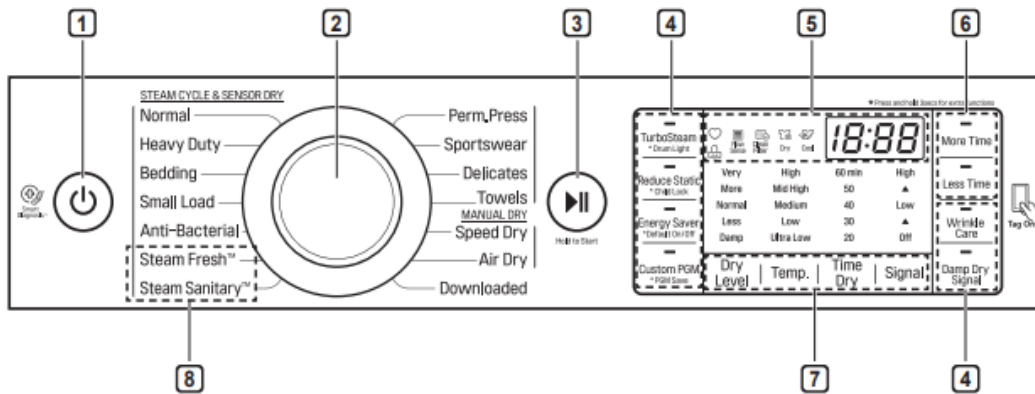

**NOTE** Model numbers can be found on the cabinet inside the door.

### 1. POWER Button

Press to turn the dryer ON. Press again to turn the dryer OFF.

**NOTE** Pressing the POWER button during a cycle will cancel that cycle and any load settings will be lost.

### 2. Cycle Selector Knob

Turn this knob to select the desired cycle. Once the desired cycle has been selected, the standard presets are shown in the display. On Manual Dry cycles, these settings can be adjusted using the cycle modifier buttons any time before starting the cycle.

### 3. START/PAUSE Button

Press this button to start the selected cycle. If the dryer is running, use this button to pause the cycle without losing the current settings.

**NOTE** If you do not press the START/PAUSE button to resume a cycle within 4 minutes, the dryer turns off automatically.

### 4. Cycle option Buttons

The option buttons allow you to select additional cycle options. Certain buttons also allow you to activate special functions by pressing and holding the button for 3 seconds.

### 5. Time and Status Display

The display shows the settings, estimated time remaining, options, and status messages for your dryer.

### 6. MORE TIME/LESS TIME Buttons

Use these buttons with the Time Dry and other MANUAL DRY cycles to adjust the drying time. Press the More Time button to increase the selected manual cycle time by 1 minute; press the Less Time button to decrease the cycle time by 1 minute.

### 7. Cycle Modifier Buttons

Use these buttons to select the desired cycle settings for the selected cycle. The current settings are shown in the display. Press the button for that option to select other settings.

### 8. Steam Functions

LG's steam technology allows you to inject fabrics with a swirling jet of steam to refresh clothes, reduce static, and make ironing easier. Simply select the Steam Fresh™ cycle or Wrinkle Free cycle.

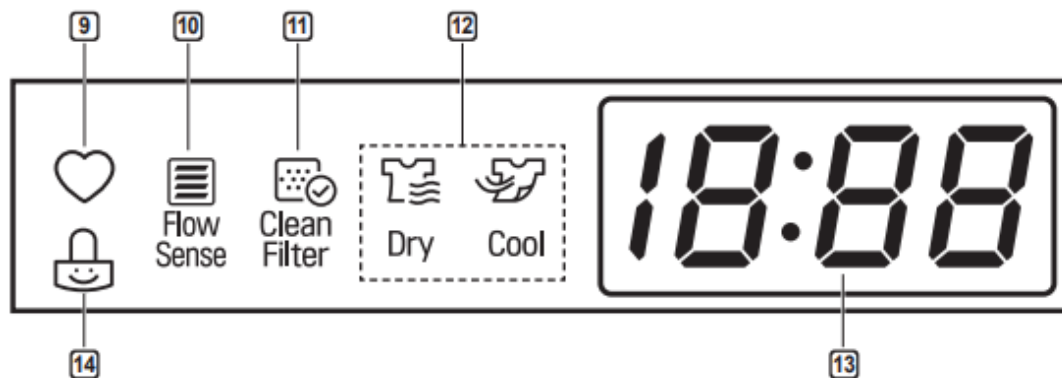

### 9. Custom PGM

If you have a special combination of settings that you use frequently, you can save these settings as a Custom Program.

#### **10. Flow Sense™ Duct Blockage Sensing System Indicator**

The Flow Sense™ duct blockage sensing system detects and alerts you to blockages in the ductwork that reduce exhaust flow from the dryer. Maintaining a clean exhaust system improves operating efficiency and helps minimize service calls, saving you money.

#### **11. Clean Filter Reminder**

The display will show Clean Filter when the dryer is turned on as a reminder to check the filter. It turns off when the START/PAUSE button is pressed.

#### **12. Cycle Completion Indicator with Check Filter Reminder**

This portion of the display shows which stage of the drying cycle is currently underway (Clean Filter, Dry, Cool).

#### **13. Estimated Time Remaining**

This display shows the estimated time remaining for SENSOR DRY cycles or the actual time remaining for Time Dry or MANUAL DRY cycles.

**NOTE** The cycle time on SENSOR DRY cycles may fluctuate as the dryer recalculates drying time for optimal results.

#### **14. Child Lock Indicator**

When Child Lock is set, the Child Lock indicator will appear and all buttons will be disabled except the POWER button. This prevents children from changing settings while the dryer is operating.

## Cycle Guide

### Cycle Guide

= default setting  
 = allowable option

Cycle	Fabric Type	Dry Level	Temperature	Time	More Time/ Less Time	Wrinkle Care	Turbo Steam	Damp Dry Signal	Reduce Static	Energy Saver
Steam Fresh™	Comforter, Shirts, Trousers (except especially delicate fabrics)	Off	Mid High	10	<input type="radio"/>	<input type="radio"/>	<input type="checkbox"/>			
			Adjustable	Adjustable						
Steam Sanitary™	Comforter, Bedding, Children's clothing	Off	High	31		<input type="radio"/>	<input type="checkbox"/>			
Anti-Bacterial	Do not use this cycle with delicate fabrics.	Very Dry	High	1:10		<input type="radio"/>				
Small Load	Only Normal & Cotton/Towels Fabric Type (Max 3 lb)	Normal Dry	High	30		<input type="radio"/>				
		Adjustable								
Bedding	Comforters, Pillows, Shirts	Normal Dry	Medium	55					<input type="radio"/>	
		Adjustable								
Heavy Duty	Jeans, heavyweight items	Normal Dry	High	54		<input type="radio"/>	<input type="radio"/>	<input type="radio"/>	<input type="radio"/>	
		Adjustable								
Normal	Work clothes, corduroys, etc.	Normal Dry	Medium	Elec : 67 Gas : 63		<input type="radio"/>	<input type="radio"/>	<input type="radio"/>	<input type="radio"/>	<input type="radio"/>
		Adjustable								
Perm. Press	Permanent press, synthetic items	Normal Dry	Low	32		<input type="radio"/>	<input type="radio"/>	<input type="radio"/>	<input type="radio"/>	
		Adjustable								
Towels	Denims, towels, heavy cottons	Normal Dry	Mid High	55		<input type="radio"/>		<input type="radio"/>	<input type="radio"/>	
		Adjustable								
Sportswear	Sports Wear	Off	-	27		<input type="radio"/>			<input type="radio"/>	
Delicates	Lingerie, sheets, blouses	Normal Dry	Low	28		<input type="radio"/>		<input type="radio"/>	<input type="radio"/>	
		Adjustable								
Speed Dry	For small loads with short drying times	Off	High	25	<input type="radio"/>	<input type="radio"/>			<input type="radio"/>	
			Adjustable	Adjustable						
Air Dry	For items that require heat-free drying such as plastics or rubber	Off	No Heat	30	<input type="radio"/>	<input type="radio"/>				
				Adjustable						

## Cycle Settings and Options

### Cycle Modifier Buttons

SENSOR DRY cycles have preset settings that are selected automatically. MANUAL DRY cycles have default settings, but you may also customize the settings using the cycle modifier buttons. Press the button for that option to view and select other settings.

### Dry Level

Selects the level of dryness for the cycle. Press the Dry Level button repeatedly to scroll through available settings.

- This option is only available with SENSOR DRY cycles.
- The dryer will automatically adjust the cycle time. Selecting More Dry or Very Dry will increase the cycle time, while Less Dry or Damp Dry will decrease the cycle time.
- Use a Less Dry or Damp Dry setting for items that you wish to iron.

## **Temp.**

Adjusts the temperature setting. This allows precise care of your fabrics and garments. Press the Temp. Control button repeatedly to scroll through available settings.

## **Time Dry**

Allows you to manually select the drying time, from 20 to 60 minutes, in 10-minute increments. Use this for small loads or to remove wrinkles.

## **More Time/Less Time**

Use the More Time/Less Time buttons to add or reduce the drying time of a MANUAL DRY cycle in 1-minute increments.

## **Signal (Option)**

Press the Signal (Option) button repeatedly to change the volume or turn on/off the button tones and the end of cycle melody.

## **Cycle Option Buttons**

The dryer features several additional cycle options to customize cycles to meet individual needs. Certain option buttons also feature a special function that can be activated by pressing and holding that option button for 3 seconds. (See Special Functions on the following page for details.)

### **Adding Cycle Options to a Cycle:**

1. Turn on the dryer and press the CYCLE buttons to select the desired cycle.
2. Use the cycle modifier buttons to adjust the settings for that cycle.
3. Press the cycle option button(s) for the option you would like to add. A confirmation message is shown in the display.
4. Press the START/PAUSE button to start the cycle. The dryer starts automatically.

## **Wrinkle Care**

Selecting this option will tumble the load periodically for up to 3 hours after the selected cycle, or until the door is opened. This is helpful in preventing wrinkles when you are unable to remove items from the dryer immediately.

## **Damp Dry Signal**

With this option, the dryer will signal when the load is approximately 80% dry. This allows you to remove faster-drying lightweight items or items that you would like to iron or hang while still slightly damp.

## Special Functions

Some cycle option buttons also activate secondary functions. These special functions are marked with an asterisk (\*). Press and hold the option button marked with the special function to activate it.

### \* Drum Light

The drum is equipped with a blue LED that illuminates when the dryer is turned on. This light automatically turns off when the door is closed and the cycle starts. To turn on the light during a cycle, press and hold the TurboSteam button for three seconds. The drum light will illuminate and then turn off automatically after four minutes.

### \* Child Lock

Use this option to prevent unwanted use of the dryer or to keep cycle settings from being changed while the dryer is operating.

Press and hold the button marked Child Lock for 3 seconds to activate or deactivate the Child Lock function. The Child Lock icon will be shown in the display, and all controls will be disabled except the POWER button.

**NOTE** Once set, Child Lock remains active until it is manually deactivated. Child Lock must be turned off to run another cycle. To deactivate Child Lock, press and hold the Child Lock button for 3 seconds.

### Energy Saver (on some models)

This option helps to reduce energy consumption in the Normal cycle, depending on the load size. When the Energy Saver option is selected, the cycle begins with an air dry section and the drying time is increased.

**NOTE** The Energy Saver option is turned on by default in the Normal cycle. Turn off the Energy Saver option for a faster Normal cycle which begins with heated drying.

### \* Default On/Off

This option allows the Energy Saver settings to be changed. To run a Normal cycle without the Energy Saver option, press and hold the Energy Saver button for three seconds. ON or OFF appears in the display

### Custom PGM

If you have a special combination of settings that you use frequently, you can save these settings as a custom program.

### Saving a Custom Program:

1. Turn on the dryer and press the CYCLE buttons to select the desired cycle.
2. Use the cycle setting buttons to adjust the settings for that cycle.

3. Press the cycle option button(s) for the option you would like to add. A confirmation message will be shown in the display.
4. Press and hold the Custom PGM button for 3 seconds.

**NOTE** You may save only one custom program at a time. Pressing and holding the Custom PGM button will overwrite any previously saved custom program.

#### **Recalling a Custom Program:**

1. Turn on the dryer.
2. Press the Custom PGM button.
3. Press the START/PAUSE button to start the cycle.

### **Steam Functions**

LG's new steam technology allows you to inject fabrics with a swirling jet of hot steam to refresh clothes and reduce static, or sanitize clothes. Simply select the Steam Fresh™ cycle or the Steam Sanitary™ cycle. Or you can add a steam option to selected cycles.

#### **Using the Steam Fresh™ cycle**

Steam Fresh™ uses the power of steam alone to quickly reduce wrinkles and odors in fabrics. It brings new life to wrinkled clothes that have been stored for an extended time. Steam Fresh™ can also be used to help reduce odors and remove the hanger creases in fabrics.

**NOTE** Depending on the load size, change the cycle time by pressing More Time or Less Time. The display shows 1, 3, 5, or **b' 9**. Select 3 for up to three items; select 5 for four or five items; and select **b' 9** for a large load, a bulky item like a blanket, or to remove hanger creases.

#### **To use the Steam Fresh™ cycle:**

1. Turn on the dryer and turn the cycle selector knob to select the Steam Fresh™ cycle.
2. To add an option function, select Wrinkle Care.
3. Depending on the load (quantity of items), steam time can be changed by pressing the More Time or Less Time buttons.
4. Press Start/Pause button to start the cycle.

#### **Using the Steam Sanitary™ cycle**

The new Steam Sanitary™ cycle is ideal for sanitizing non-washable items quickly and easily using the power of steam alone. This cycle is recommended for use with cotton and polyester materials. (Do NOT use for urethane foam, down feathers or delicate items.)

#### **Using the steam options:**

The Reduce Static option injects steam late in the drying cycle to reduce the static electricity caused by dry fabrics rubbing together. Change the amount of time for the cycle by pressing the More Time or Less Time button, depending on the load (quantity of items). The display will show the recommended number of items, such as 7, 9, 11, 14, 16, or 18. TurboSteam helps prevent the overdrying of clothes by injecting steam during the drying process. The Steam Shield Function extends the life of clothes.

**NOTE**

- When Sensor Dry is selected with the Reduce Static or Turbo Steam option, a Dry level of Less or Damp cannot be selected.
- The Reduce Static option may also be selected during Time Dry cycles.
- After the Steam option is selected in Time Dry, the More Time or Less Time buttons will change the steam time only.
- After pressing Start/Pause, the More Time or Less Time buttons will be disabled.

**To add steam to a standard cycle:**

1. Turn on the dryer and turn the cycle selector knob to select the desired cycle.
2. Use the cycle setting buttons to adjust the settings for that cycle.
3. Press the steam option button for the steam option you would like to add. Then adjust for the load size using the More Time or Less Time buttons.
4. Press Start/Pause to start the cycle.

**Steam Cycle Guide**

	Steam	Default Time	Temp. Control	Dry Level	Fabric State	Fabric Type	Maximum Amount
<b>Steam Sanitary™</b>		31 minutes			Dry	Comforter Bedding	Single (1 each)
			Children's clothing	3 lbs.			
<b>Steam Fresh™</b>		10 minutes	○		Dry	Comforter	Single (1 each)
			Shirts*	5 each			
<b>Steam Option</b>	+ Reduce Static	Follows Selected Cycle		○	Wet	Varies by selected cycle	8 lbs. (18 Items.)
	+ Turbo Steam			○		Wet	Varies by selected cycle
<b>Time Dry</b>	+ Reduce Static	38 minutes	○		Wet	Varies by selected cycle	8 lbs. (18 Items.)

\*Shirt: 70% cotton:30% poly blend. Except especially delicate fabrics.

- When the lint filter or exhaust duct is clogged, steam options will not give proper results.
- For best results, load articles of similar size and fabric type. Do not overload.



# SMART FEATURES

## Tag On (on some models)

### Before Using Tag On

The Tag On function allows you to conveniently use the LG Smart Diagnosis™, Cycle Download, Laundry Stats and Tag On Cycle Set features to communicate with the appliance from a smart phone. To use the Tag On function:

1. Download the LG Smart Laundry & DW application to the smart phone.
2. Turn on the NFC (Near Field Communication) function on the smart phone. The Tag On function can only be used with smart phones equipped with the NFC function and based on the Android operating system (OS).

### Turning On the Smart Phone's NFC Function

1. Enter the Settings menu of the smart phone and select Share & connect.

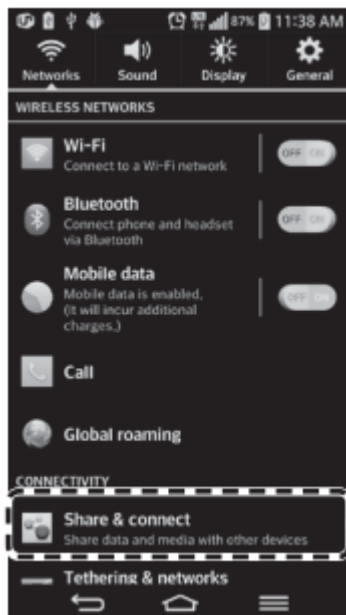

2. Set NFC to ON.



**NOTE** Depending on the smart phone manufacturer and Android OS version, the NFC activation process may differ. Refer to the manual of the smart phone for details.

### Using the Tag On Function

The Tag On Icon 

Look for the Tag On icon on the right side of the dryer's control panel. Position the smart phone over the icon when using the Tag On function with the LG Smart Set features of the LG Smart Laundry & DW application.

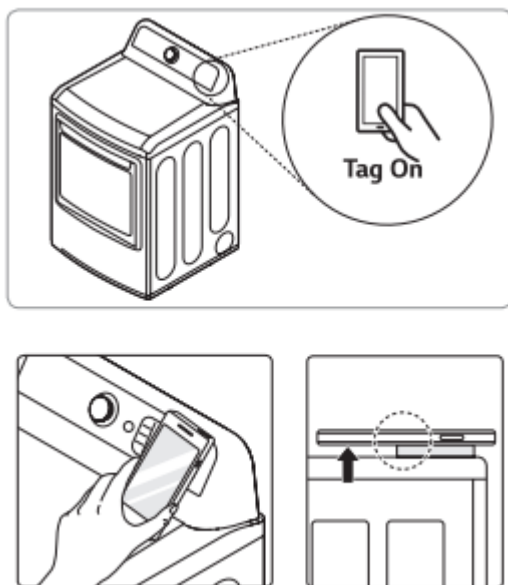

### The NFC Antenna Position

When you use the Tag On function, position your smart phone so that the NFC antenna inside the back of your smart phone matches the position of the Tag On icon on the

appliance. (Because you cannot see the position of the antenna, the LG Smart Laundry & DW app will attempt to find it for you and show you a target range for the antenna on your smart phone's screen.)

If the app is not able to show a target range, try positioning the center back of your smart phone over the Tag On icon on the appliance. If the connection is not made immediately, move your smart phone very slightly in a widening circular motion until the application verifies the connection.

Because of the characteristics of NFC, if the transmission distance is too far, or if there is a metal sticker or a thick case on the phone, transmission will not be good.

Press [ ? ] in the LG Smart Laundry & DW app for a more detailed guide on how to use the Tag On function.

## Using Tag On With Apps

LG Smart Diagnosis™, Cycle Download, Laundry Stats and Tag On Cycle Set in the LG Smart Laundry & DW apps use the Tag On function when you touch the LG appliance's Tag On logo with your NFC-equipped smart phone.

**NOTE** Images are for reference only. The actual LG Smart Laundry & DW application is subject to change for product improvement purposes.

- Before using the LG Smart Diagnosis™, Cycle Download, Laundry Stats and Tag On Cycle Set, download the application from the Google Play Store and install it.
- Select Tag On using either the scrollable icons or the stationary bottom icons.



## Tag On Diagnosis

The Tag On Diagnosis app helps you to troubleshoot problems with your appliance using the Tag On function and an NFC-equipped smart phone based on the Android operating system (OS).

1. Select Tag On Diagnosis.



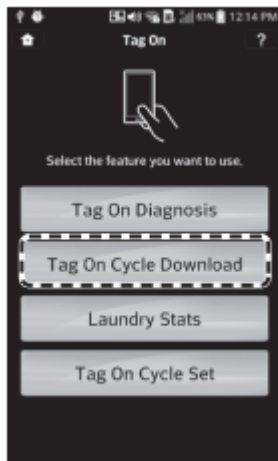

2. Touch the Tag On logo.

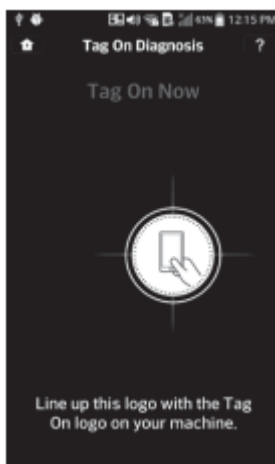

3. Check the diagnosis results and solutions.

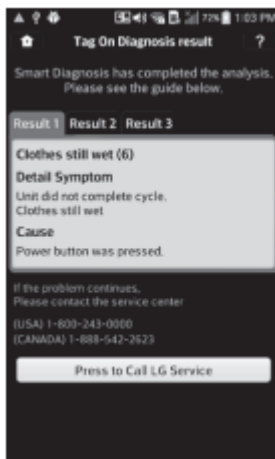

- The app shows the diagnosis results of the cycles recently used.
- If the results are unclear, or if they suggest calling the LG Service Center, see the Call Center Diagnosis section for instructions.

## Call Center Diagnosis

If you receive a diagnosis from either the Tag On Diagnosis or Smart Diagnosis™ app that is unclear or directs you to call the LG Service Center, follow these instructions:

1. Select Press to Call LG Service on the Smart Diagnosis Result screen.

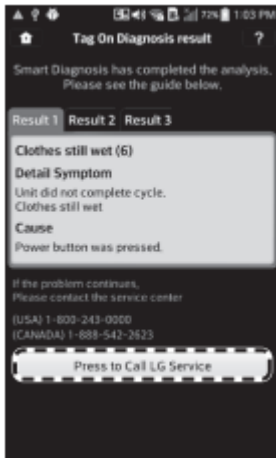

2. Select your country.
3. Agree to Terms and Conditions of the Use and Privacy Policy by pressing I accept.

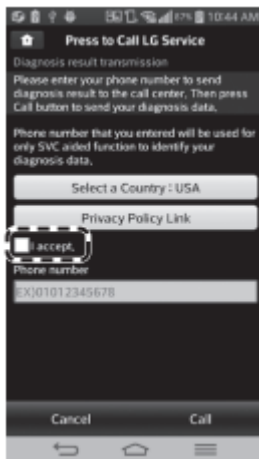

4. Enter your phone number in the field. Use this phone number when talking to LG Customer Service to allow them to find your Smart Diagnosis data.



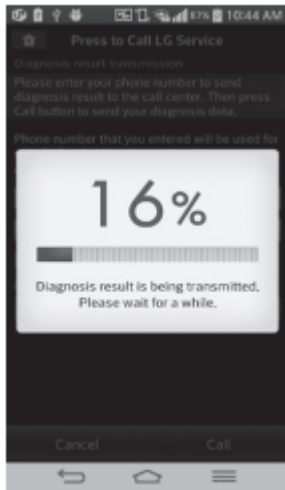

5. Press the Call button to initiate the call to LG's Support Center.

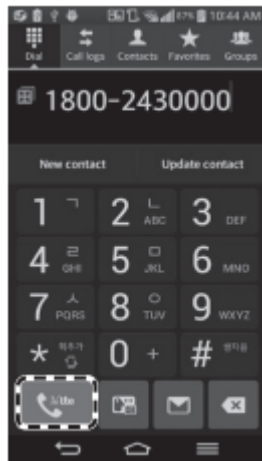

### Tag On Cycle Download

Tag On Cycle Download allows you to download cycles for later use. The cycle is available at the Download Cycle position on the control panel until another cycle is downloaded.

1. Select Tag On Cycle Download.

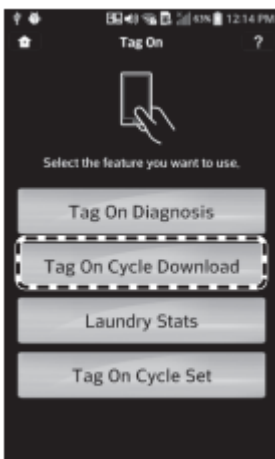

2. Touch the Tag On logo.

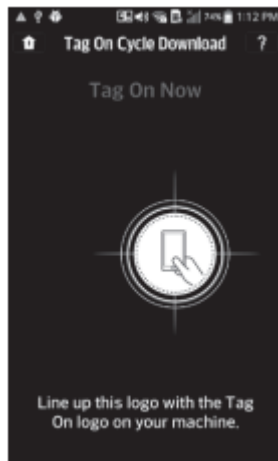

3. Select a cycle to download.

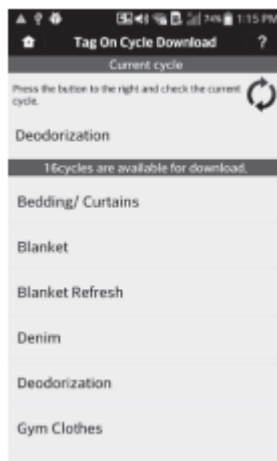

- The current downloaded cycle is at the top of the screen and the available cycles are below that. You can also confirm the existing downloaded cycle.

4. Touch the Tag On logo.

- When a Tag On screen appears, tap your smart phone on the Tag On icon on the right side of the dryer's control panel.

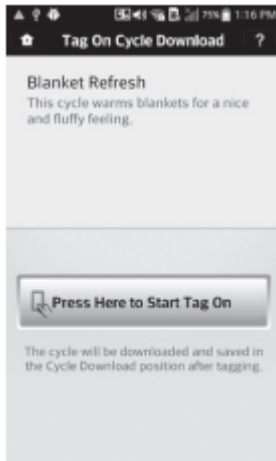

5. The new cycle is downloaded successfully!

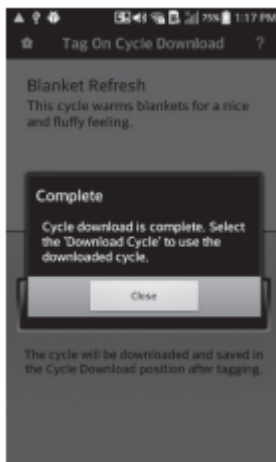

- Check whether the new cycle is downloaded by turning the cycle selector knob to Download Cycle.

## Laundry Stats

Tag On Laundry Stats allows you to check the Flow Sense status on your appliance to check if your home exhaust system is clogged and also display the details of your last ten cycles.

## Flow Sense™ Status

- LG's Flow Sense duct blockage sensing system detects and alerts you to restrictions in the installed household ductwork that reduce exhaust airflow through the dryer

1. Select Laundry Stats.

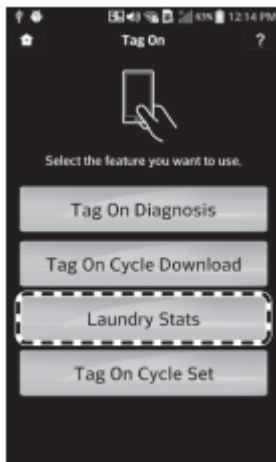

2. Touch the Tag On logo.

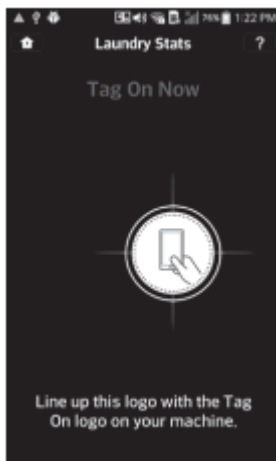

3. Check the Flow Sense status result.



4. If the status shows your home exhaust system is blocked, press the Venting Tips button.

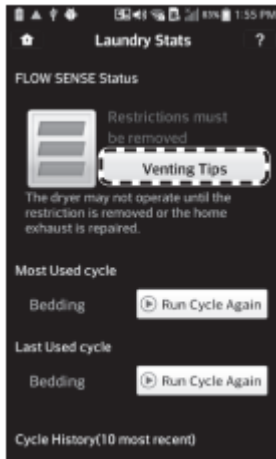

## Run Cycle Again

1. Select the Run Cycle Again button.

- The Most Used cycle or Most Recent cycle can be immediately started by selecting the Run Cycle Again button.

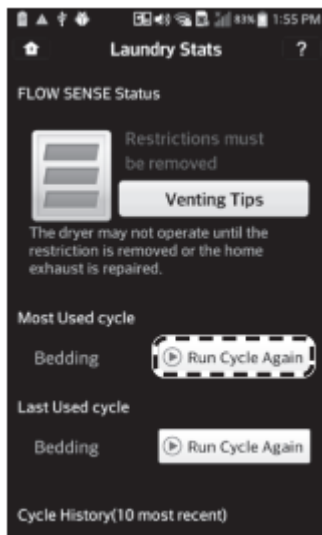

2. Touch the Tag On logo.

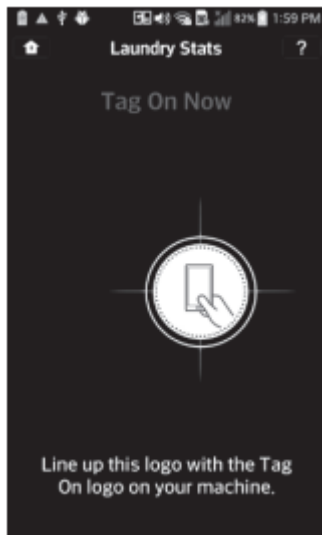

3. Check whether drying starts with the selected cycle.

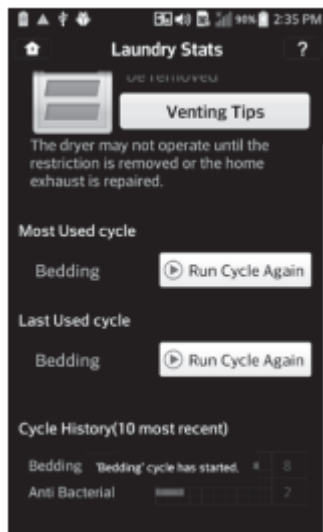

- The screen shown above appears and drying starts immediately on the selected cycle.

### Tag On Cycle Set

Tag On Cycle Set allows you to automatically adjust the cycle and settings based on your laundry needs.

1. Select Tag On Cycle Set.

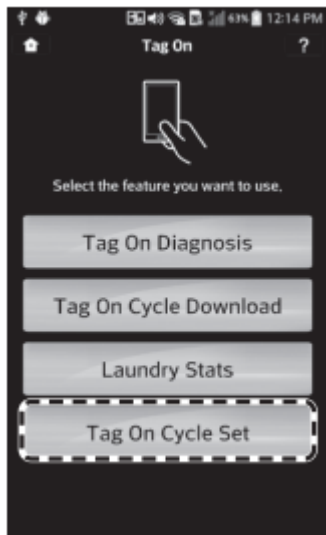

2. Touch the Tag On logo.

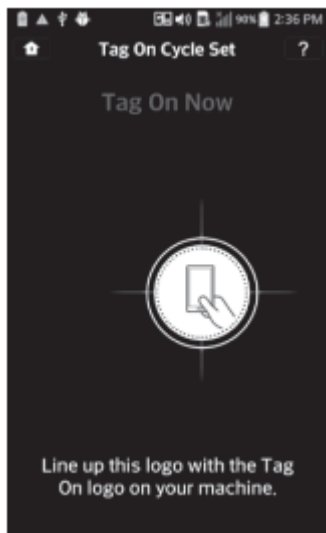

3. Select a laundry category based on the issue you want the machine to focus on.

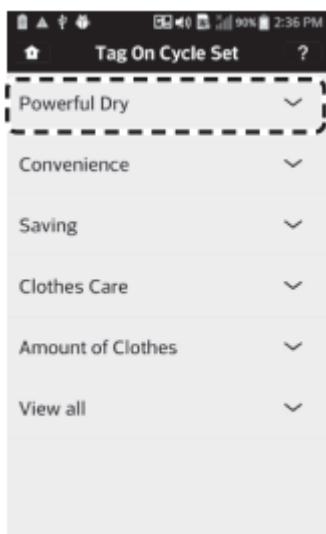

4. After selecting the category, a list of specific cycles will appear. Select the cycle based on your needs.

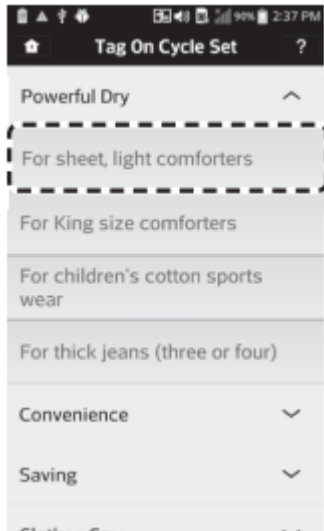

5. When the Tag On screen appears, tap your smart phone to the Tag On logo on the right side of the dryer's control panel.

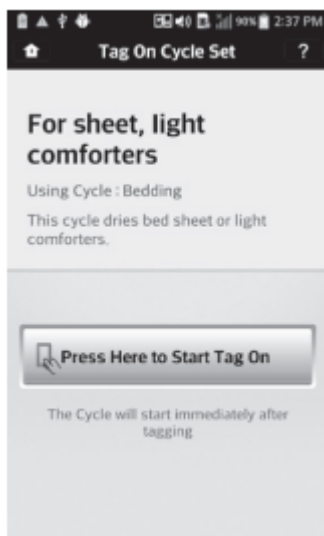

6. After tagging the machine with your phone, the cycle will automatically start. Verify that the correct cycle and settings were selected.

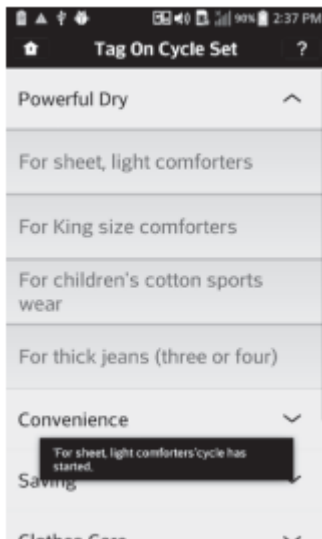

## MAINTENANCE

### Regular Cleaning

#### Cleaning the Exterior

Proper care of your dryer can extend its life. The outside of the machine can be cleaned with warm water and a mild, nonabrasive household detergent. Immediately wipe off any spills with a soft, damp cloth.

#### NOTE

- Do not use methylated spirits, solvents, or similar products.
- Never use steel wool or abrasive cleansers; they can damage the surface.

#### Cleaning the Interior

Wipe around the door opening and seal with a soft, damp cloth to prevent lint and dust buildup that could damage the door seal.

Clean the window with a soft cloth dampened with warm water and a mild, nonabrasive household detergent, then wipe dry.

The stainless steel drum can be cleaned with a conventional stainless steel cleaner, used according to the manufacturer's specifications. Never use steel wool or abrasive cleansers; they may scratch or damage the surface.

#### Cleaning Around and Under the Dryer

Vacuum lint and dust from around the dryer and underneath it regularly. Vent ductwork should be checked for lint buildup and cleaned at least once per year. If any noticeable reduction in airflow or drying performance occurs, immediately check ductwork for obstructions and blockages.

## Maintaining Ductwork

Vent ductwork should be checked for lint buildup once per month and cleaned at least once per year. If any noticeable reduction in airflow or drying performance occurs, immediately check ductwork for obstructions and blockages. Contact a qualified technician or service provider.

## Cleaning the Lint Filter

Always clean the lint from the filter after every cycle.

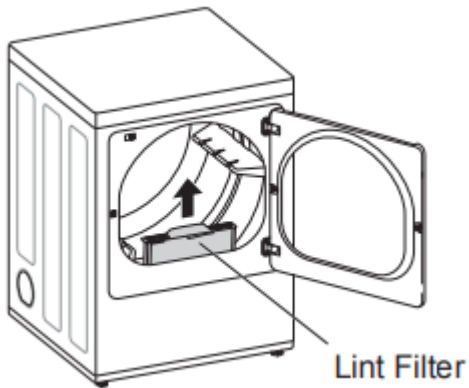

To clean, open the dryer door and pull the lint filter straight up. Then:

1. For everyday cleaning, roll any lint off the filter with your fingers, or



2. Vacuum the lint filter.

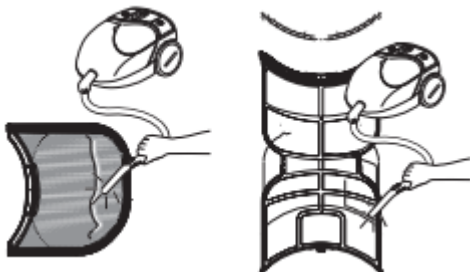

3. If the lint filter has become very dirty or clogged with fabric softener, wash the lint filter in warm, soapy water and allow it to dry thoroughly before reinstalling.



**NOTE** NEVER operate the dryer without the lint filter in place. NEVER operate the dryer with a wet lint filter.

## Troubleshooting

### FAQs: Frequently Asked Questions

**Q: When I press a button, why does my dryer beep and then nothing happens?**

**A:** The Child Lock feature is turned on. To turn off Child Lock, turn the dryer on, then press and hold the button that has \*Child Lock on or under it for 3 seconds.

**Q: Why does my dryer take so long to dry clothes?**

**A:** Proper airflow is critical to the efficient operation of clothes dryers. A lint filter which is full of lint or clogged with fabric softener sheet residue can reduce the airflow to the point that the time required to dry clothing will be greatly increased. Another factor affecting dry time is your home exhaust system. An exhaust system which is dirty and clogged with lint, or is excessively long, needs to be professionally cleaned or repaired.

**Q: Why does my dryer start by itself every few minutes?**

**A:** This is how the Wrinkle Care feature works. The dryer runs briefly every few minutes for up to 3 hours after the cycle finishes. This feature is designed to help prevent wrinkles from setting in when the dryer is not unloaded immediately after the cycle is finished.

**Q: Why does my dryer show 3 minutes when I select the Steam Fresh™ cycle?**

**A:** When the Steam Fresh™ cycle is selected, the dryer displays the number of garments rather than the estimated cycle time, until the cycle is started. Use the More Time or Less Time buttons to adjust the load size setting for the number of garments you desire. For a large load or single bulky item use the **bi 9** (big) setting.

### Before Calling for Service

This dryer is equipped with an automatic error-monitoring system to detect and diagnose problems at an early stage. If the dryer does not function properly or does not function at all, check the following before you call for service.

### Operation

Problem	Possible Cause	Solutions
<p><b>The Flow Sense™ indicator remains active after clearing the restriction in the venting.</b></p>	<p>After clearing the restriction, the Flow Sense™ system requires multiple, consecutive cycles to determine that the performance value has improved before the Flow Sense™ indicator is reset.</p>	<p>If the Flow Sense™ indicator remains active for more than five cycles after the restriction has been cleared, call for service.</p>
<p><b>Dryer will not turn on</b></p>	<p>Power cord is not properly plugged in.</p>	<p>Make sure that the plug is securely plugged into a grounded outlet matching the dryer's rating plate.</p>
	<p>House fuse is blown, circuit breaker has tripped, or power outage has occurred.</p>	<p>Reset circuit breaker or replace fuse. Do not increase fuse capacity. If the problem is a circuit overload, have it corrected by a qualified electrician.</p>
<p><b>Dryer does not heat</b></p>	<p>House fuse is blown, circuit breaker has tripped, or power outage has occurred.</p>	<p>Reset circuit breaker or replace fuse. Do not increase fuse capacity. If the problem is a circuit overload, have it corrected by a qualified electrician.</p> <p><b>NOTE</b> Due to the design of electric dryers, it is possible for a circuit problem to allow an electric dryer to run without heat.</p>
	<p>Gas supply or service is turned off (gas models only).</p>	<p>Confirm that the house gas shutoff and the dryer gas shutoff valves are both fully open. Even if gas is not supplied to the dryer, it will run and no error codes will display. Verify</p>



		that other gas appliances in the home are working normally.
	Energy Saver option selected (on some models)	If using the Cotton/Normal cycle, deselect the energy saver option. The Energy Saver option is selected by default. This option reduces energy use by adding an air dry section to the beginning of the cycle. It is normal to feel no heat at the beginning of the cycle while in Energy Saver mode.
<b>Display show error code nP or gAS</b>	Power cord connection is incorrect.	Check the connection of power cord to the terminal block.
	Gas supply or service turned off (Gas models only).	Confirm that house gas shutoff and the dryer gas shutoff are both fully open.
<b>Clothes take too long to dry</b>	Exhaust ducts are blocked, dirty, or duct run is too long.	Confirm that the exhaust duct is properly configured and free of debris, lint, and obstructions. Make sure that outside wall dampers can open properly and are not blocked, jammed, or damaged.
	Load is not properly sorted.	Separate heavy items from lightweight items. Larger and heavier items take longer to dry. Light items in a load with heavy items can fool the sensor because the light items dry faster.
<b>Clothes take too long to dry</b>	Large load of heavy fabrics.	Heavy fabrics take longer to dry because they tend to retain more moisture. To help reduce and maintain more consistent drying times for large and heavy fabrics, separate these items into smaller loads of a consistent size.

<p>Dryer controls are not set properly.</p>	<p>Use the appropriate control settings for the type of load you are drying. Some loads may require an adjustment of the dry level setting for proper drying.</p>
<p>Lint filter needs to be cleaned.</p>	<p>Remove the lint from the filter before every load. With the lint removed, hold the filter up to a light to see if it is dirty or clogged. With some loads that produce high amounts of lint, such as new bath towels, it may be necessary to pause the cycle and clean the filter during the cycle.</p>
<p>House fuse is blown, circuit breaker has tripped, or power outage has occurred.</p>	<p>Reset circuit breaker or replace fuse. Do not increase fuse capacity. If the problem is a circuit overload, have it corrected by a qualified electrician.</p> <p><b>NOTE</b> Due to the design of electric dryers, it is possible for a circuit problem to allow an electric dryer to run without heat.</p>
<p>Dryer is overloaded.</p>	<p>Divide extra large loads into smaller loads for better drying performance and efficiency</p>
<p>Dryer is underloaded.</p>	<p>If you are drying a very small load, add a few extra items to ensure proper tumbling action. If the load is very small and you are using SENSOR DRY cycles, the electronic control cannot properly sense the dryness of the load and may shut off too soon. Use TIME DRY or add some extra wet clothes to the load.</p>



<p><b>Clothes take too long to dry</b></p>	<p>Energy Saver option selected (on some models)</p>	<p>If using the Cotton/Normal cycle, deselect the Energy Saver option. This option reduces energy use by adding an air dry section to the beginning of the cycle.</p>
<p><b>Drying time is not consistent</b></p>	<p>Heat settings, load size, or dampness of clothing is not consistent.</p>	<p>The drying time for a load will vary depending on the type of heat used (electric, natural gas, or LP gas), the size of the load, the type of fabrics, the wetness of the clothes, and the condition of the exhaust duct and lint filter. Even an unbalanced load in the washer can cause poor spinning, resulting in wetter clothes which will take longer to dry.</p>

**Performance**



<b>Problem</b>	<b>Possible Cause</b>	<b>Solutions</b>
<b>Greasy or dirty spots on clothes</b>	Fabric softener used incorrectly.	Confirm and follow the instructions provided with your fabric softener.
	Clean and dirty clothes are being dried together.	Use your dryer to dry only clean items. Soil from dirty clothes can transfer to the clean clothes in the same or later loads.
	Clothes were not properly cleaned or rinsed before being placed in the dryer.	Stains on dried clothes could be stains that were not removed during the washing process. Make sure that clothes are being completely cleaned or rinsed according to the instructions for your washer and detergent. Some difficult soils may require pre-treating prior to washing.
<b>Clothes are wrinkled</b>	Clothes dried too long (over dried).	Over drying a load of laundry can lead to wrinkled clothes. Try a shorter drying time or LESS DRY setting and remove items while they still retain a slight amount of moisture.
	Clothes left in dryer too long after cycle ends.	Use the WRINKLE CARE option. This feature will tumble the clothes briefly every few minutes for up to 3 hours to help prevent wrinkling.
<b>Clothes are shrinking</b>	Garment care instructions are not being followed.	To avoid shrinking your clothes, always consult and follow fabric care instructions. Some fabrics will naturally shrink when washed. Other fabrics can be washed but will shrink when dried in a dryer. Use a low or no heat setting.
<b>Lint on clothes</b>	Lint filter not cleaned properly.	Remove the lint from the filter before every load. With the lint removed, hold the filter up to a light to see if it is dirty or clogged. If it looks dirty, follow the cleaning instructions. With some loads that produce high amounts

		of lint, it may be necessary to clean the filter during the cycle.
	Laundry not sorted properly.	Some fabrics are lint producers (i.e., a fuzzy white cotton towel) and should be dried separately from clothes that are lint trappers (i.e., a pair of black linen pants).
<b>Lint on clothes</b>	Excess static in clothes.	Use a fabric softener to reduce static electricity. Be sure to follow the manufacturer's instructions. Overdrying a load of laundry can cause a buildup of static electricity. Adjust settings and use a shorter drying time, or use SENSOR DRY cycles.
	Dryer is overloaded.	Divide extra large loads into smaller loads for drying.
	Tissue, paper, etc., left in pockets.	Check pockets thoroughly before washing and drying clothes.
<b>Excess static in clothes after drying</b>	Fabric softener is not used or used incorrectly.	Use a fabric softener or the STATIC SHIELD option, if equipped, to reduce static electricity. Be sure to follow the manufacturer's instructions.
	Clothes dried too long (overdried).	Overdrying a load of laundry can cause a buildup of static electricity. Adjust settings and use a shorter drying time, or use AUTO DRY cycles. Select a LESS DRY setting on SENSOR DRY cycles, if necessary
	Drying synthetics, permanent press, or synthetic blends.	These fabrics are naturally more prone to static buildup. Try using fabric softener, or use LESS DRY and/or shorter TIME DRY time settings.
<b>Clothes have damp spots after a</b>	Very large load or very small load. Single large item	If items are too tightly packed or too sparse the sensor may have trouble reading the

<p><b>SENSOR DRY cycle.</b></p>	<p>such as a blanket or comforter.</p>	<p>dryness level of the load. Use a Time Dry cycle for very small loads.</p> <p>Large, bulky items such as blankets or comforters can sometimes wrap themselves into a tight ball of fabric. The outside layers will dry and register on the sensors, while the inner core remains damp. When drying a single bulky item, it may help to pause the cycle once or twice and rearrange the item to unwrap and expose any damp areas.</p> <p>To dry a few remaining damp items from a very large load or a few damp spots on a large item after a sensor cycle has completed, empty the lint trap, then set a Time Dry cycle to finish drying the item(s).</p>
---------------------------------	--	---

**Steam Functions (Steam Models)**





<b>Problem</b>	<b>Possible Cause</b>	<b>Solutions</b>
<b>Water drips from nozzle when STEAM CYCLE starts</b>	This is normal.	This is steam condensation. The dripping water will stop after a short time.
<b>Garments still wrinkled after Steam Fresh™</b>	Too many or overly different types of garments in dryer.	Small loads of 1 to 5 items work best. Load fewer garments. Load similar types of garments.
<b>Creases or pleats are gone from garments after Steam Fresh™</b>	The function of this cycle is to remove wrinkles from fabric.	Use an iron to replace creases and pleats in garments.
<b>Garments have static after using the Reduce Static option</b>	This is normal.	The amount of static experienced will depend on the individual moisture level in the skin.
<b>Garments are too damp or too dry after using the Reduce Static option</b>	Correct drying options not selected.	Select the load weight manually before starting the Reduce Static option.
<b>Garments are not uniformly damp after using the Easy Iron option</b>	Number of garments or load size not properly selected at the beginning of the cycle.	Select the correct number of garments or load size before starting the cycle.
<b>Steam does not generate, but no error code is shown</b>	Water level error.	Unplug dryer and call for service.

<b>Water drips from door during STEAM CYCLE</b>	This is normal.	Condensation will normally form on the inside of the dryer door during steam operation. Some condensation may drip out the bottom of the door.
<b>Steam is not visible during STEAM CYCLE</b>	This is normal.	Steam vapor is difficult to see when the door is closed. However, condensation will normally form on the inside of the dryer door if the steam system is operating normally.
<b>Drum does not turn during STEAM CYCLE</b>	This is normal.	The drum is turned off so that the steam vapor remains in the drum. The drum will normally turn for about 2 seconds once a minute.
<b>Cannot see steam vapor at the beginning of cycle</b>	This is normal.	Steam is released at different stages of the cycle for each option.
<b>Odors remain in clothing after Steam Fresh™</b>	Steam Fresh™ did not remove odor completely.	Fabrics containing strong odors should be washed in a normal cycle.

## Error Codes

Problem	Possible Cause	Solutions
<b>Error code: tE1 through tE7</b>	Temperature sensor failure.	Turn off the dryer and call for service.
<b>Display shows error code: PS (electric dryers only)</b>	Power cord is connected incorrectly.	Check the connection of the power cord to the terminal block.
<b>*Flow Sense™ indicator shows four bars during the drying cycle or the display shows "d80" after drying</b>	Exhaust system is too long or has too many turns/restrictions.	Install a shorter or straighter duct run. See the Installation Instructions for details.
	Partial blockage of the ductwork due to lint buildup or other foreign object.	Ductwork should be checked/cleaned immediately. Dryer can be used in this condition, but drying times will be longer and energy consumption will increase.
<b>* This warning light is not a dryer failure and is not covered by the dryer warranty. Contact a duct cleaning service to set up an appointment to have your exhaust system cleaned and inspected.</b>	The appliance has detected a restriction in the external dryer venting.	If exhaust restrictions are sensed by the Flow Sense™ system, the indicator will remain on for 2 hours after the end of the cycle. Opening the door or pressing the POWER button will turn off the display.
<b>The Flow Sense™ indicator remains active after clearing the restriction in the venting.</b>	After clearing the restriction, the Flow Sense™ system requires multiple, consecutive cycles to determine that the performance value has improved before the	If the Flow Sense™ indicator remains active for more than five cycles after the restriction has been cleared, call for service.



	Flow Sense™ indicator is reset.	
 <b>indicator light is on during the drying cycle</b>	Water supply error.	<p>Check steam feeder drawer:</p> <p>(1) Make sure the steam feeder is filled with water to the MAX line.</p> <p>(2) Make sure the steam feeder is seated properly and the drawer is fully closed.</p> <p>(3) Turn the dryer off then restart the STEAM CYCLE.</p> <p>Do not use distilled water; the water level sensor in the steam generator will not work.</p> <p>Pump not working. Unplug dryer and call for service.</p>
<b>The display shows</b> <i>bl 9</i>	More Time button was pressed.	<p>This display indicates that the steam option has been set for a “big” item such as a comforter.</p> <p>Press the Less Time button to reduce the indicated load size.</p>
 <b>indicator light is on during the drying cycle</b>	Lint filter not cleaned properly.	<p>Remove the lint from the filter before every load. With the lint removed, hold the filter up to a light to see if it is dirty or clogged. If it looks dirty, follow the cleaning instructions. With some loads that produce high amounts of lint, it may be</p>

		necessary to clean the filter during the cycle.
<p><b>Add</b> indicator light is on during the drying cycle</p>	Water supply error.	<p>Check steam feeder drawer:</p> <p>(1) Make sure the steam feeder is filled with water to the MAX line.</p> <p>(2) Make sure the steam feeder is seated properly and the drawer is fully closed.</p> <p>(3) Turn the dryer off then restart the STEAM CYCLE.</p> <p>Do not use distilled water; the water level sensor in the steam generator will not work.</p>
	Pump not working.	Unplug dryer and call for service.
<p><b>The display shows d90, d95</b></p> 	<p>The duct work is about 90%-95% blocked. ("d90" or "d95" error code is displayed for 2 hours only)</p> <p>House exhaust system blocked.</p>	<p>Do not use the dryer until the exhaust system has been cleaned and/or repaired. Using the dryer with a severely restricted exhaust is dangerous and could result in a fire or other property damage.</p> <p>Check the outside dryer vent while the dryer is operating to make sure there is strong airflow.</p> <p>If the exhaust system is extremely long, have it repaired or rerouted.</p> <p>Keep the area around the dryer clean and free of clutter.</p>

		<p>Check vent hood for damage or lint clogging.</p> <p>Make sure the area around the vent hood is clear.</p>
--	--	--

## SMART DIAGNOSIS™

Should you experience any problems with your dryer, it has the capability of transmitting data to your smart phone using the LG Smart Laundry Application or via your telephone to the LG call center.

Smart Diagnosis™ cannot be activated unless your dryer is turned on by pressing the POWER button. If your dryer is unable to turn on, then troubleshooting must be done without using Smart Diagnosis™.

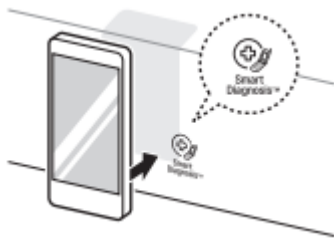

## Using Smart Diagnosis™

### Smart Diagnosis™ Using Your Smart Phone

1. Download the LG Smart Laundry & DW application on your smart phone.
2. Open the LG Smart Laundry application on your smart phone. Press the right arrow button to advance to the next screen.
3. Press the Record button on the smart phone and then hold the mouth piece of the smart phone near the Smart Diagnosis™ logo on the dryer.
4. With the phone held in place, press and hold the Temp. Control button for 3 seconds.
5. Keep the phone in place until the tone transmission has finished. The display will count down the time.
6. When the recording is complete, view the diagnosis by pressing the Next button on the phone.

### NOTE

- Call quality differences by region may affect the function.
- Use a home telephone for better communication performance, resulting in better service.

- Poor call quality may result in poor data transmission from your phone to the machine, which could cause Smart Diagnosis™ to malfunction.

### Smart Diagnosis™ Through the Call Center

1. Call the LG call center at: (LG U.S.) 1-800-243-0000 (LG Canada) 1-888-542-2623.
2. When instructed to do so by the call center agent, hold the mouthpiece of your phone over the Smart Diagnosis™ logo on the machine. Hold the phone no more than one inch from (but not touching) the machine.

**NOTE** Do not touch any other buttons or icons on the display screen.

3. Press and hold the Temp. Control button for 3 seconds.
4. Keep the phone in place until the tone transmission has finished. The display will count down the time.
5. Once the countdown is over and the tones have stopped, resume your conversation with the call center agent, who will then be able to assist you in using the information transmitted for analysis.

### NOTE

- For best results, do not move the phone while the tones are being transmitted.
- If the call center agent is not able to get an accurate recording of the data, you may be asked to try again.

#### Warning

This content is compiled from multiple sources and is provided for reference purposes only. It may not be complete or fully applicable to all situations. If you are unable to resolve your issue, please contact the product manufacturer or an authorized service provider for official support.