

DESCRIPTION

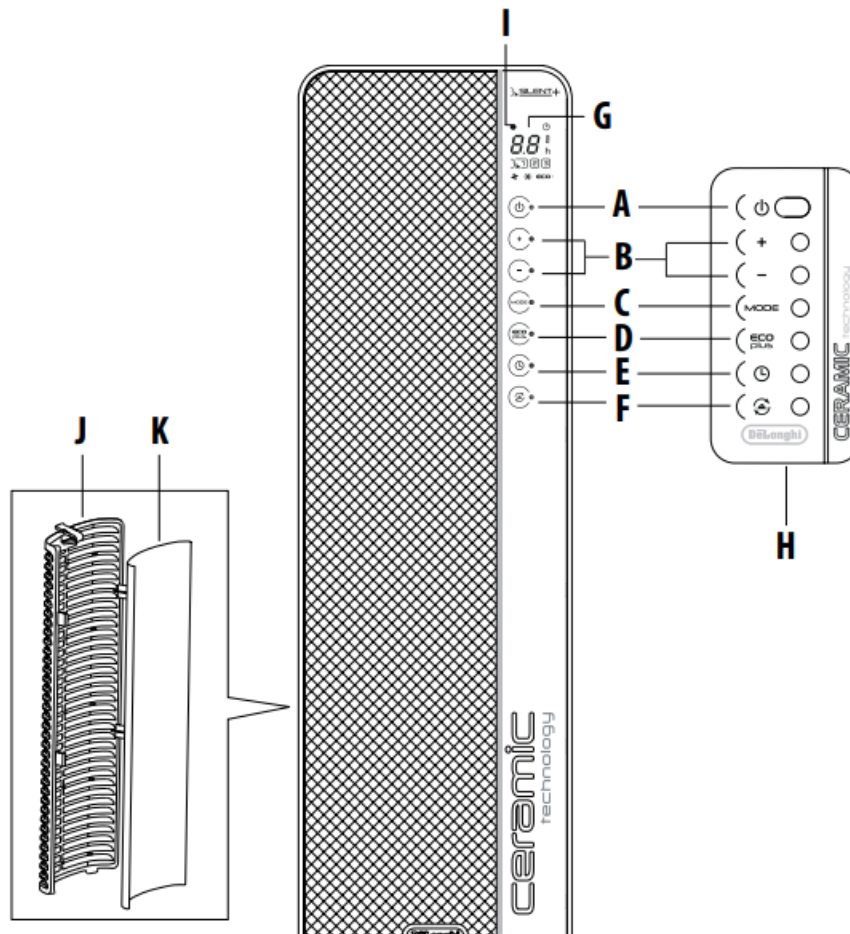

- A** ON/STAND-BY button
- B** +/- adjustment buttons
- C** MODE button (selects the operating mode)
- D** “ECO plus” button
- E** Timer button
- F** Swing button
- G** Remote control receiver
- H** Indicator light
- I** Air intake grille
- J** Filter

USE

Installation

- The appliance can be used on any horizontal surface. Do not overload the electrical circuit. Avoid using the same socket for other appliances.

Electrical connection

- Before plugging the appliance into the mains socket, check that the mains power supply corresponds to the value indicated on the rating plate and that the mains power supply is adequate for the load.
- THIS APPLIANCE COMPLIES WITH DIRECTIVE 2004/108/ EEC ON RADIO INTERFERENCE SUPPRESSION.

Mounting the base

- Fit the two parts of the base together, matching the guide pins on the front with the recesses on the back and snapping the two clips into place (fig. A and fig. B).
- Turn the appliance upside down and position the assembled base on the appliance in order to couple the two openings with the two tabs on the appliance, tilting it as shown in figure C, consequently turn the base down till the two frontal teeth snaps into position.

Operation and use

1. Plug into the mains socket.
2. The appliance emits a beep. The indicator light (**H**) comes on and remains lit while the appliance is powered.
3. The appliance switches to stand-by. A dot flashing on the display means the tip over device has been activated.

See paragraph: "Safety functions".

4. Press the ON/STAND-BY (**A**) to turn the appliance on. It begins heating the room according to the current settings.
5. Press the MODE button (**C**) to select one of the following operating modes:

Fan 

Freeze prevention 

Heating 1 

Heating 2 

Heating 3 

5.1 Fan

In this mode, only the fan operates and the appliance does not heat the room.

5.2 Freeze prevention

In this mode, the appliance keeps the room at a temperature of 7°C to avoid freezing.

5.3 Heating 1, 2 and Heating 3

In this mode, the desired temperature can be selected by pressing the adjustment buttons + and – (B):

• Heating 1

The appliance operates at low power, reducing noise levels and energy consumption to a minimum.

• Heating 2

The appliance operates at medium power.

• Heating 3

The appliance operates at high power to heat the room rapidly.

6. “ECO plus” function

The “ECO plus” function is available in Heating 1, 2 and 3 modes only.

To activate the function, press the “ECO plus” button (D). When this function is active the appliance automatically sets the most appropriate power level to guarantee optimum comfort while reducing energy consumption.

While the “ECO plus” function is active, the appliance may switch automatically to a lower heating power than the one displayed. This may happen a number of times in an hour.







7. To distribute the air flow over a wider surface, press the swing button (F) . The appliance starts swinging to the right and left. To stop the appliance in the desired position, simply press the swing button (F) again.

8. To turn the appliance off, press the ON/STAND-BY button (A). The display may visualize a countdown for about 6 seconds.

Please note: Room temperature can be displayed in either °C or °F. To change the unit of measurement for the temperature, press the + button for a few seconds, then release.

Digital 24 h timer

This function can be activated from any operating mode.

Auto-start: with the appliance in STAND-BY, press the timer button  (E) . The  symbol is displayed together with the time remaining before the appliance comes on. To adjust the timer, use the adjustment buttons + and (B), then wait a few seconds for the setting to be memorised. The stand-by light (H) is displayed together with the  symbol, indicating that the timer has been set. When the programmed time is reached, the appliance comes on with the settings used during the previous period of operation. **Auto-off:** with the appliance on, press the timer button  (E). The  symbol is displayed together with the time remaining before the appliance goes off. To set the timer, use the adjustment buttons + and (B), then wait a few seconds for the setting to be memorised. The current settings are displayed again, together with the symbol  indicating that the timer has been set. When the programmed time is reached, the appliance goes off automatically. To go back to operation without the timer, press the timer button (E) twice. The timer symbol  disappears from the display.

Using the remote control

The functions on the remote control are the same as those on the appliance control panel. For a description of the functions, see the “Operation and use” section on the previous page.

Inserting or replacing the batteries

The remote control is powered by a CR2032 lithium battery.

To operate the remote control, pull and remove the plastic strip under the battery cover.

To replace the batteries, remove the battery cover by sliding it as shown in the figure.

When replacing the batteries, position, simply press the swing button (F) again. 8. To turn the appliance off, press the ON/STAND-BY button (A). The display may visualize a countdown for make sure you respect the polarity (see figure 2).

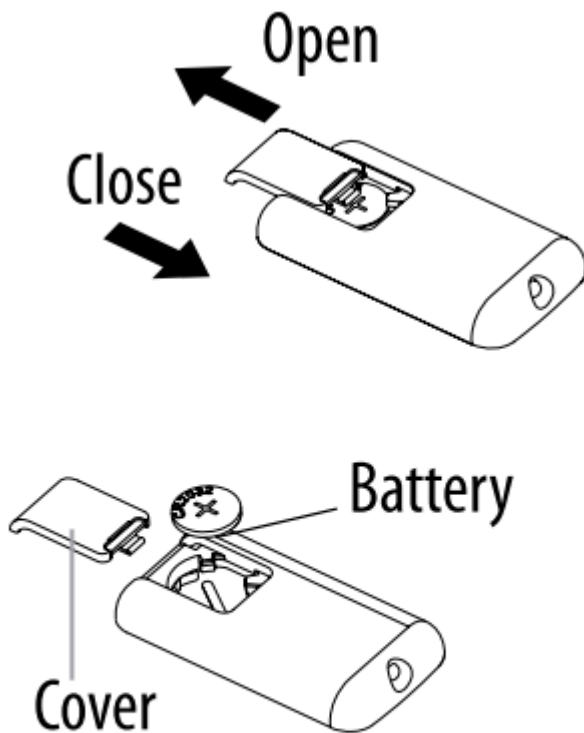

Fig. 2

Replace the cover as shown in the figure. Old batteries are harmful to the environment and must be removed and disposed of in compliance with current legislation.

MAINTENANCE

- Always unplug from the mains socket before cleaning. During the season when the appliance is in use, clean the air intake and outlet grilles regularly using a vacuum cleaner.
- To clean the filter, remove the rear grille by pulling it outwards (fig. 1).
- Remove the dust filter which retains impurities in the air drawn in from the room, blow on it lightly then replace in the appliance.
- Never use abrasive powders or solvents to clean the appliance.

TECHNICAL CHARACTERISTICS

Power supply Absorbed power - See rating plate

TROUBLESHOOTING

PF display and emits a beep	Temperature sensor is not working properly	The product needs to be serviced, contact our toll free number for assistance
Product doesn't turn on	Check that the plug is connected to the outlet Auto-start is on Room temperature reaches the set temperature	Plug in Wait till time elapsed or press the but ton (E) twice to cancel the auto-start and push the button (A) Use the "+" button to increase the set temperature
The appliance goes off unexpectedly	Check that the plug is connected to the outlet The set temperature has been reached or the time set on the timer has elapsed	Plug in
A green dot is flashing and unit is off	The tip-over switch has been activated	Make sure the appliance is standing upright on a flat surface, if the problem persists contact our toll free number to assist you

PROBLEM	CAUSE	SOLUTION
PF display and emits a beep	Temperature sensor is not working properly	The product needs to be serviced, contact our toll free number for assistance
Product doesn't turn on	Check that the plug is connected to the outlet Auto-start is on Room temperature reaches the set temperature	Plug in Wait till time elapsed or press the but ton (E) twice to cancel the auto-start and push the button (A) Use the "+" button to increase the set temperature
The appliance goes off unexpectedly	Page 6 Check that the plug is connected to the outlet	Plug in

IMPORTANT SAFEGUARDS



- The appliance must not be placed immediately under a fixed power socket.
- Do not use the appliance near showers, bathtubs, sinks, swimming pools, etc.
- If the power cable is damaged, it must be replaced by the manufacturer, an authorised service centre or a qualified electrician in order to eliminate all risk.



- This appliance can be used by children aged from 8 years and above and persons with reduced physical, sensory or mental capabilities or lack of experience and knowledge if they have been given supervision or instruction concerning use of the appliance in a safe way and understand the hazards involved. Children shall not play with the appliance. Cleaning and user maintenance shall not be made by children without supervision.
- Children of less than 3 years should be kept away unless continuously supervised.
- Children aged from 3 years and less than 8 years shall only switch on/off the appliance provided that it has been placed or installed in its intended normal operating position and they have been given supervision or instruction concerning use of the appliance in a safe way and understand the hazards involved. Children aged from 3 years and less than 8 years shall not plug in, regulate and clean the appliance or perform user maintenance.

CAUTION Some parts of this product can become very hot and cause burns. Particular attention has to be given where children and vulnerable people are present.

- **ATTENTION:** To avoid the safety system resetting accidentally, this appliance must not be powered through an external on/off device such as a timer, or connected to a circuit which is turned off and on regularly by the energy supplier.
- Do not use the appliance in small rooms when they are occupied by persons that are not capable of leaving the room, unless constant supervision is provided.



WARNING: To avoid overheating, never under any circumstances cover the appliance during operation as this would lead to a dangerous rise in temperature.



Please note:

- Always use the appliance in an upright position.
- The use of extension leads is not recommended. However if they cannot be avoided, follow the instructions accompanying the extension lead and never exceed the power limit marked on the extension.
- The heater must be positioned at least 50 cm from furniture or other objects.
- Do not use the appliance in rooms with a floor area of less than 4m².
- Before putting the appliance away, make sure it is completely off and unplugged from the mains socket. Wrap the cable around the base.
- Do not store in dusty atmospheres.
- Do not rest anything on the appliance.
- Do not use the appliance to dry laundry. Do not obstruct the air intake and outlet grilles (danger of overheating).
- Do not use the appliance near walls, furniture, curtains, etc.

Safety functions

- **Safety device:** the appliance is fitted with a safety device which switches it off in the event of accidental overheating (e.g. obstruction of air intake and outlet grilles, motor turning slowly or not at all).

To reset, unplug the appliance from the mains socket for a few minutes, remove the cause of overheating then plug in again.

- **Tip over safety device:** a tip over safety device turns the appliance off if it falls over or is positioned inappropriately in such a way as to jeopardise safety.

The appliance emits a beep and a dot flashes on the display. The appliance resumes operation a few seconds after being placed in an upright position again.

Disposing of the appliance



In compliance with European directive 2002/96/EC, the appliance must not be disposed of with household waste, but taken to an authorised waste separation and recycling centre.

INTRODUCTION

Thank you for choosing a De'Longhi product.

Please take a few minutes to read these instructions. This will avoid all risks and damage to the appliance.

Symbols used in these instructions

Important warnings are identified by the symbols below. It is important to respect the warnings. Failure to respect the warnings could lead to electric shock, serious injury, burns, fire or damage to the appliance.

Danger!

Failure to observe the warning may result in life threatening injury by electric shock.

Important!

Failure to observe the warning could result in injury or damage to the appliance.

Danger of burns!!

Failure to observe the warning could result in burns or scalds.

Please note:

This symbol indicates recommendations and important information for the user.

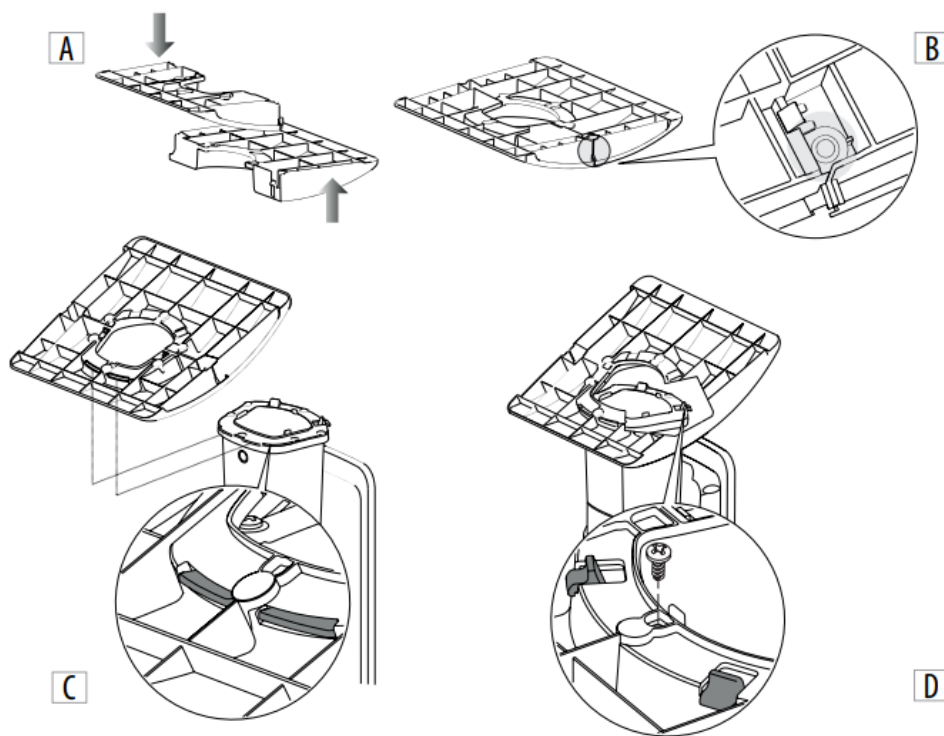

Warning

This content is compiled from multiple sources and is provided for reference purposes only. It may not be complete or fully applicable to all situations. If you are unable to resolve your issue, please contact the product manufacturer or an authorized service provider for official support.

