

## VACUUM ASSEMBLY

### CARTON CONTENTS

- A. Handle\*
- B. Vacuum Base
- C. Extension Wand
- D. Crevice Tool\*
- E. Pet Upholstery Tool\*
- F. Dusting Brush\*
- G. (1) Large Screw
- H. Dirt Cup
- I. Pet Stair Tool\*

\*Varies per model.

Remove all parts from carton and identify each item shown.

Make sure all parts are located before disposing of packing materials.

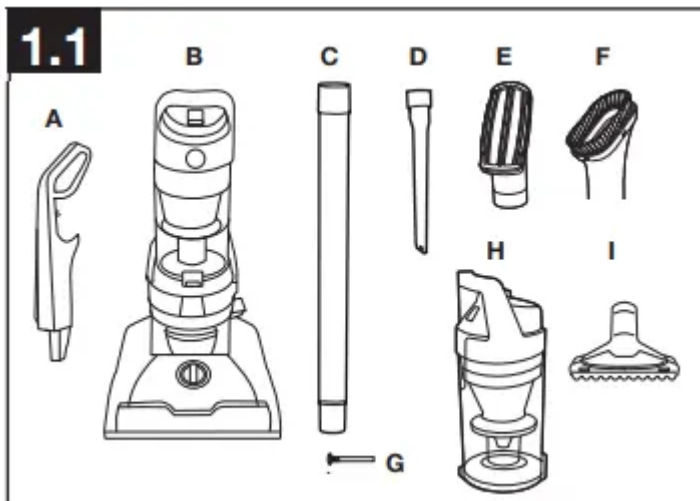

### ATTACH HANDLE

1.2 Insert handle section into vacuum base. Push down firmly. Using a Phillips screwdriver, fasten (1) large screw behind handle into vacuum base.

1.3 Wrap hose around top of hose guide located on the handle. Insert the hose into hose tube until you hear a click

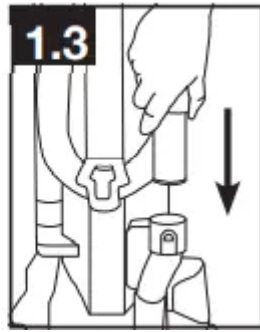

## POSITION TOOLS

1.4 Place Crevice Tool into the bottom of the extension wand and slide onto the unit on the left back side (C) of vacuum and place the Dusting Brush on right back side (E) of vacuum as shown.

1.5 Place Pet Upholstery Tool\*/ Pet Stair Tool\* (F) on top of the wand.

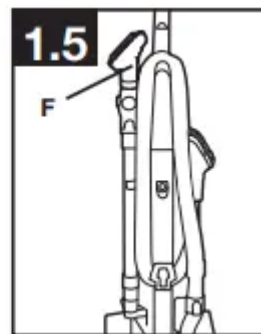
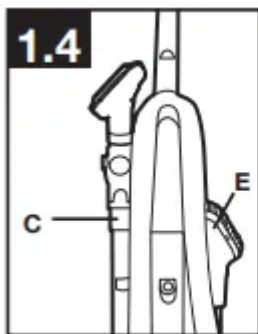

## ATTACH DIRT CUP

1.6 Place bottom of dirt cup into vacuum body first. Pivot cup into vacuum. Dirt cup is secure when you hear a click



## HOW TO USE

### VACUUM DESCRIPTION

1. Handle
2. Dirt Cup Release Button
3. Carry Handle
4. System Check Indicator

5. Rinsable Filter Access
6. Dirt Cup
7. Exhaust Filter
8. Height Adjustment
9. Furniture Guard
10. Pet Upholstery Tool/Pet Stair Tool\*
11. Extension Wand
12. Crevice Tool (inside wand)\*
13. Handle Release Pedal
14. Hose
15. Dusting Brush\*
16. ON/OFF Switch
17. Hose Release Button
18. Hose Connecting Tube

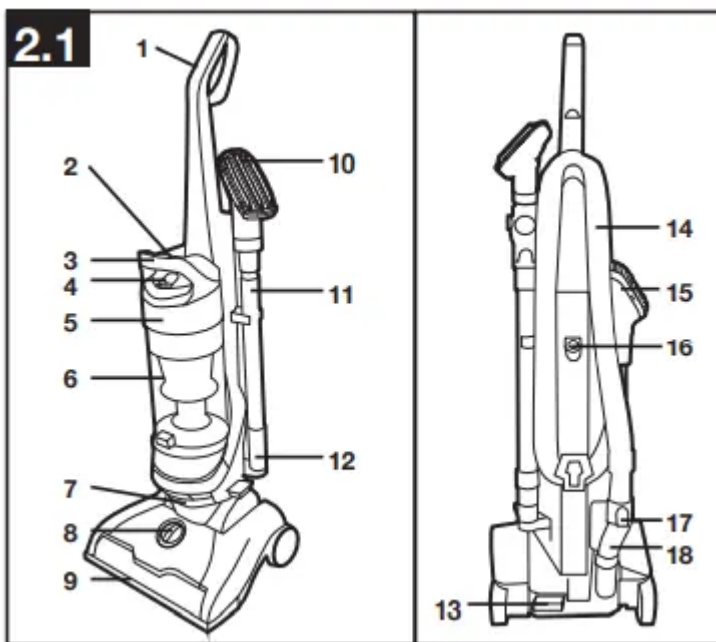

### ON-OFF SWITCH

2.2 Plug cord into electrical outlet. To turn vacuum ON (I=ON), push ON/OFF switch (A) to ON position. To turn vacuum OFF (O=OFF), push switch to OFF position.

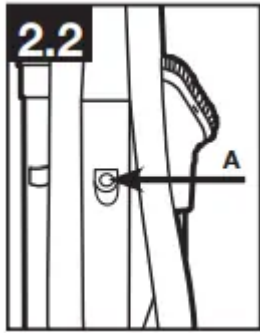

## CARPET HEIGHT ADJUSTMENT

2.3 To adjust height setting, PUSH DOWN and TURN knob (C) to desired height setting. For maximum cleaning performance, the following carpet height settings are recommended:

- Hard floor setting: for use on hard floors only.
- Low through High settings: Adjust depending on carpet type.
- For high pile carpet, use high carpet setting to ease pushing effort

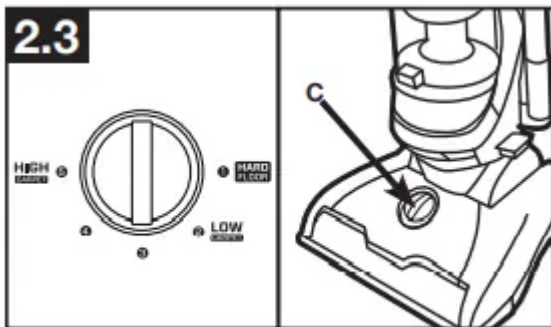

\*Number of height settings vary per model.

**IMPORTANT** If the vacuum is difficult to push, push down and turn knob to the next higher setting.

## TOOLS

Tools allow for cleaning surfaces above the floor and for reaching hard to clean areas. The vacuum is ready for tool use when handle is in upright position

**IMPORTANT** Brushroll continues to turn while product is turned on and handle is in upright position. To avoid damage to carpet, rugs, furniture and flooring, avoid tipping cleaner or setting it on furniture, fringed area rugs, or carpeted stairs during tool use

### SELECT PROPER TOOL

- Extension Wand is used to give extra length to your hose. Use it with any of the tools.
- Crevice Tool may be used in tight spaces, corners and along edges in such places as dresser drawers, upholstered furniture, stairs and baseboards.
- Dusting Brush has delicate bristles that gently clean fine dust.

D. Use the Pet Upholstery Tool to clean upholstered furniture, draperies, mattresses, clothing and carpeted stairs.

E\*. The Pet Stair Tool is for cleaning stairs and hard to reach areas.

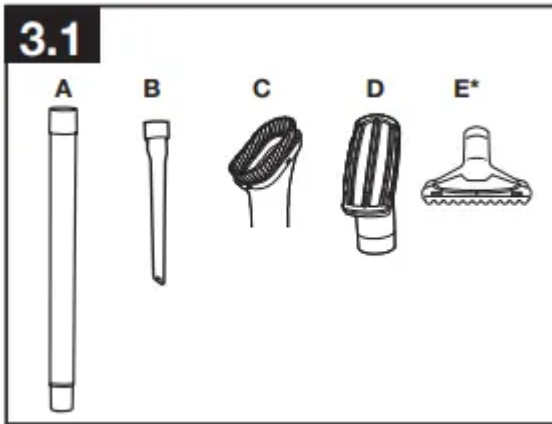

### REMOVING HOSE

3.2 To remove hose for tool use, press the hose release button and pull hose end out. To lock back into place, push hose into hose tube until you hear a click.



### ATTACH WAND AND TOOLS

3.3 To attach tool or wand to hose, push firmly into place.



### HOW TO CLEAN TOOLS

To clean Hose, wipe with a damp cloth. DO NOT submerge in water. Other cleaning tools may be washed in warm water with a detergent. Rinse and air dry 24 hours before using.

## MAINTENANCE

Familiarize yourself with these home maintenance tasks as proper use and care of your vacuum will ensure continued cleaning effectiveness.

4.1 The System Check Indicator located at (A), alerts you to possible system performance issues.

### If System Check Indicator is red:

- Rinsable filter and/or exhaust filter is dirty.
  - Clean rinsable filter and/or exhaust filter
- Dirt cup is full and/or clogged.
  - Empty dirt cup
- Cyclone filter assembly is clogged.
  - Clean cyclone filter assembly per

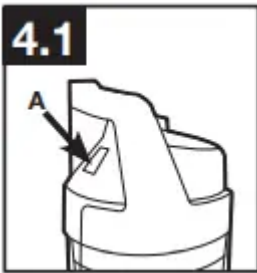

### NOTICE

A Thermal Protector has been designed into your cleaner to protect it from overheating. When the thermal protector activates the cleaner will stop running.

1. If this happens proceed as follows:
2. Turn cleaner OFF and unplug it from the electrical outlet.
3. Empty dirt cup.
4. Inspect the nozzle inlet, host connector, hose, dirt cup inlet, cyclonic filter, rinsable filter and exhaust filter. Clear obstructions if present.
5. When cleaner is unplugged and motor cools for 30 minutes, the thermal protector will deactivate and cleaning may continue.

If the thermal protector continues to activate after following the above steps, your cleaner needs servicing.

### DIRT CUP: When to Empty

4.2 To maintain optimal performance, empty the dirt cup before the dirt cup reaches the max line (B). Place the vacuum in the upright position before removing the dirt cup.

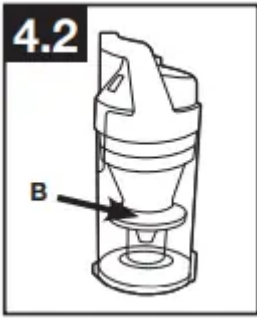

### How to Empty

4.3 Press dirt cup release button (C) and pivot cup out.

4.4 Hold dirt cup over trash receptacle, push dirt cup door release lever (D) to open dirt cup door (E). Close dirt cup door (E). Press firmly to secure.

4.5 Place bottom of dirt cup into vacuum body first. Pivot dirt cup into vacuum body and press firmly until it locks into place.

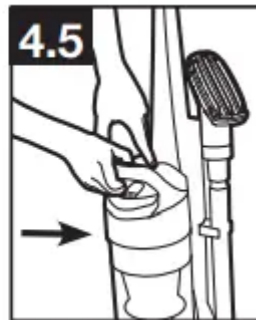
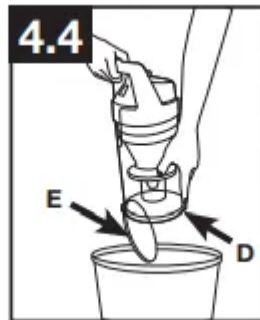
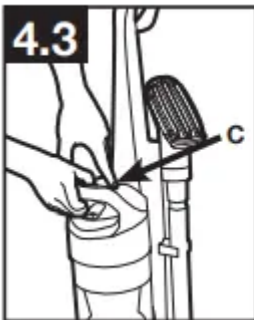

### FILTERS: When to Clean

To maintain optimal performance, filters should be cleaned at least every two months under normal use.

### Rinsable Filter: How to Clean

Remove dirt cup as described in Fig. 4.3.

4.6 Twist the dirt cup handle counterclockwise to open and remove lid.

4.7 Pull tab to remove rinsable filter.

Rinse with water for two minutes or until water runs clear. Then squeeze out excess water. Allow 24 hours for filter to dry completely. Replace filter, tab side out.

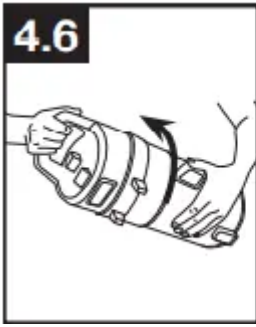

4.8 Replace dirt cup lid and twist clockwise until locked in position.

Replace dirt cup as described in Fig 4.5



**IMPORTANT** Allow filter to dry completely before replacing. Dry filter on edge so air circulates on both sides of filter. This may take up to 24 hours.

#### **Cyclonic Filter Assembly: How to Clean**

Remove dirt cup and twist the dirt cup handle counterclockwise to open and remove lid as described in 4.6.

4.9 Pull filter assembly (G) out of dirt cup and remove.

4.10 Dirt and debris can be cleaned from the filter assembly with the dusting brush.

4.11 Place the filter assembly on the dirt cup. Line up tabs (H) on lid with dirt cup body.

4.12 Replace dirt cup lid and twist clockwise until locked in position.

Replace dirt cup as described in Fig 4.5.

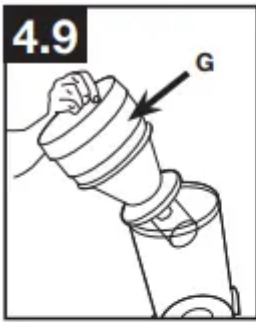

**Exhaust Filter: How to Clean**

4.13 With fingers under filter door lip, pull filter frame (A) out and away from vacuum body. Hold filter over a trash receptacle and tap out dirt and debris.

4.14 Bottom filter (B) must be pushed back into place first.

4.15 Then push the upper handle in (C) until it clicks.

4.16 Filter diagram: (B) bottom filter. (C) upper handle.

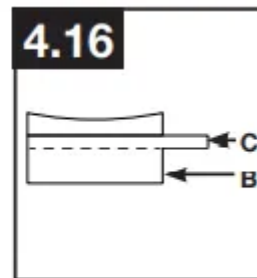
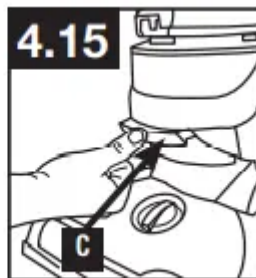
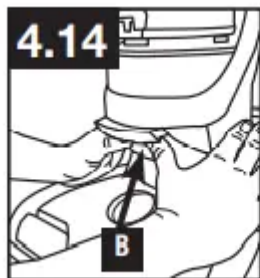
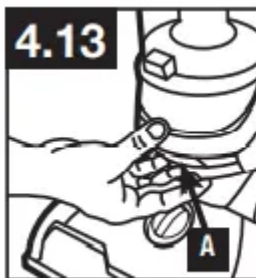

**BRUSHROLL: How to Clean**

Brushroll - Bottom plate with screws

Place handle in the low position and turn the cleaner over so the bottom side is up.

4.17 Remove the 6 screws as shown with a Phillips screwdriver.

4.18 Pivot off bottom plate.

4.19 Remove any debris and/or hair from brushroll. Replace the bottom plate aligning the screw holes and install the 6 screws as shown



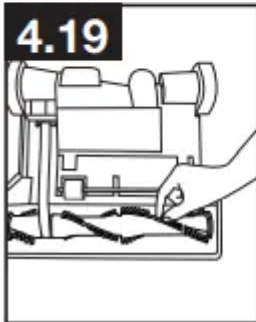
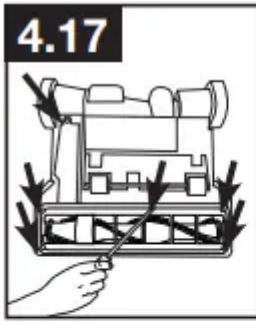

## BELT

The belt is located under the bottom plate of the vacuum and should be checked from time to time to be sure it is in good condition.

### When To Replace

Replace belt if it is damaged, cut or broken. Refer to directions below.

### How To Replace - Bottom plate with screws

Place handle in the low position and turn the cleaner over so the bottom side is up.

4.20 Remove the 6 screws as shown with a Phillips screw driver.

4.21 Lift off bottom plate (A).

4.22 Remove used belt from brushroll (C) then from motor shaft (metal rod) (D) and discard.

4.23 With lettering on outside of belt, slide new belt over motor shaft (metal rod) (E). Then slip around area of brushroll without bristles (G)

4.24 With belt in place, pull and slide brushroll into nozzle making sure that the brushroll end caps are in the correct orientation.

Place the bottom plate aligning the screw holes and re-install the 6 screws.

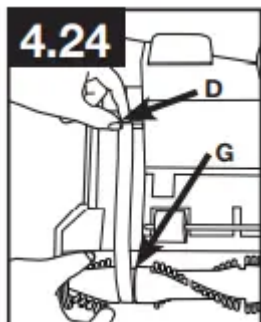
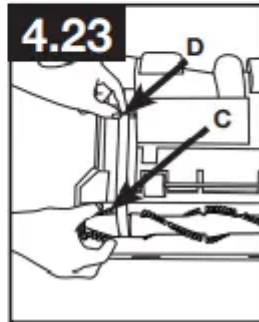
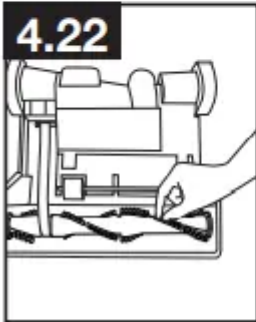

## HOSE

### How to Clean

4.25 To remove hose for tool use, press the hose release button (A) and pull hose end out. Clear away debris or obstructions from hose. Do not use sharp objects to clean out hose as they can cause damage. To lock back into place, push hose into hose tube until you hear a click.

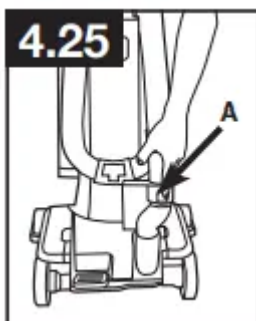

## LUBRICATION

The motor and brushroll are equipped with bearings which contain sufficient lubrication for their lifetime.

The addition of lubricant could cause damage. Do not add lubricant to motor or brushroll.

## TROUBLESHOOTING

If a minor problem occurs, it usually can be solved quite easily when the cause is found by using the checklist below.

Any other servicing should be done by an authorized service representative.

If appliance is not working as it should, has been dropped, damaged, left outdoors, or dropped into water, call Customer Service at 1-800-844-9200 prior to continuing use.

### **Vacuum won't run**

- Power cord not firmly plugged into outlet.
  - Plug unit in firmly.
- Blown fuse or tripped breaker.
  - Check fuse or breaker in home. Replace fuse/reset breaker in home.
- Thermal Protector activated.
  - Unplug and allow vacuum to cool for 30min. (This will reset the thermal protector)

### **System Check Indicator has turned red or Vacuum won't pick up or Low suction**

- Rinsable Filter and/or Exhaust Filter is dirty.
  - Clean Rinsable Filter and/or Exhaust Filter is dirty.
- Dirt cup full and/ or clogged.
  - Empty dirt cup
- Broken or worn belt.
  - Replace belt
- Brushroll and/ or Hose clogged.
  - Check Hose, Check Brushroll
- Carpet height setting is incorrect.
  - Set Carpet Height Adjustment to appropriate setting for carpet being cleaned.

### **Dust escaping from vacuum**

- Dirt cup full.
  - Empty dirt cup .
- Dirt cup not installed correctly.
  - Review Dirt Cup removal & replacement

- Hose not installed correctly.
  - Review Hose installation
- Rinsable Filter and/or Exhaust Filter not installed completely.
  - Review Filter Removal and Cleaning

### **Vacuum is difficult to push or won't move forward**

- Carpet height setting is incorrect.
  - Set Carpet Height Adjustment knob to appropriate setting for carpet being cleaned

### **Smoky/burning smell detected**

- Belt broken or stretched.
  - Replace brushroll belt
- Brushroll is clogged.
  - Clear/ remove debris from brushroll

## **SERVICE & WARRANTY**

### SERVICE INFORMATION & LIMITED WARRANTY FOR HOOVER® WINDTUNNEL HIGH CAPACITY & WINDTUNNEL MAX CAPACITY

#### LIMITED TWO YEAR WARRANTY (DOMESTIC USE)

If this product is not as warranted, contact Hoover Customer Service at 888 679-2121. Please have available the proof of purchase and model number for the warranted product.

**WHAT THIS LIMITED WARRANTY COVERS:** This limited warranty provided by Royal Appliance Mfg. Co., doing business as TTI Floor Care North America (referred to hereafter as "Hoover") applies only to products purchased in the U.S. (including its territories and possessions), a U.S. Military Exchange, or Canada. When used and maintained in normal household use and in accordance with the Owner's Guide, your Hoover® product is warranted against original defects in material and workmanship for one year from the date of original purchase (the "Warranty Period"). If Hoover determines that the issue you are experiencing is covered under the terms of this warranty (a "covered warranty claim"), we will, at our sole discretion and free of charge (subject to the cost of shipping), either repair your product or ship you a replacement product, subject to availability. Parts and replacements may be new, refurbished, lightly used, or remanufactured, in Hoover's sole discretion. If parts and replacements are unavailable, we may, at our discretion, provide a similar product of equal or greater value, a store credit (if applicable), or a refund of the actual purchase price at the time of the original purchase, as reflected on the original sales receipt.

**WHO THIS LIMITED WARRANTY COVERS:** This limited warranty extends only to the original retail purchaser, with original proof of purchase from Hoover or an authorized dealer of Hoover products, in the U.S., U.S. Military Exchanges, and Canada.

**WHAT THIS LIMITED WARRANTY DOES NOT COVER:** This warranty does not cover use of the product in a commercial operation (such as maid, janitorial, and equipment rental services, or any other income-generating activity); improper maintenance of the product; the product if it has been subject to misuse, negligence, neglect, vandalism, or the use of voltages other than that on the data plate of this product. This warranty does not cover damage resulting from an act of God, accident, owner's acts or omissions, service of this product by other than Hoover or a Hoover authorized service provider (if applicable), or other acts beyond the control of Hoover. This warranty also does not cover use outside the country in which the product was initially purchased, or resale of the product by the original owner. Pick-up, delivery, transportation, and house calls are not covered by this warranty. In addition, this warranty does not cover any product that has been altered or modified; repairs made necessary by normal wear; or the use of parts or accessories which are either incompatible with the Hoover product or adversely affect its operation, performance, or durability. Normal wear items that are not covered under this warranty include, but are not limited to, belts, filters, brush rolls, blower fans, blower and vacuum tubes, and vacuum bags and straps.

**OTHER IMPORTANT TERMS:** This warranty is not transferable and may not be assigned; any assignment made in contravention of this prohibition is void. This warranty shall be governed and construed under the laws of the state of North Carolina. The Warranty Period will not be extended by any replacement of batteries or parts or repair performed under this warranty.

**THIS WARRANTY IS THE EXCLUSIVE WARRANTY AND REMEDY, AND ALL EXPRESS AND IMPLIED WARRANTIES OTHER THAN THE LIMITED WARRANTY SET FORTH ABOVE, INCLUDING IMPLIED WARRANTIES OF MERCHANTABILITY AND FITNESS FOR A PARTICULAR PURPOSE, ARE EXPRESSLY DISCLAIMED. IN NO EVENT WILL HOOVER BE LIABLE FOR ANY SPECIAL, INDIRECT, INCIDENTAL OR CONSEQUENTIAL DAMAGES OF ANY KIND OR NATURE TO OWNER OR ANY PARTY CLAIMING THROUGH OWNER, WHETHER BASED IN CONTRACT, NEGLIGENCE, TORT, OR STRICT PRODUCTS LIABILITY OR ARISING FROM ANY CAUSE WHATSOEVER. TO THE EXTENT PERMITTED BY APPLICABLE LAW, NO WARRANTIES THAT ARISE BY OPERATION OF LAW, IF APPLICABLE, SHALL EXCEED THE DURATION OF THE LIMITED WARRANTY PROVIDED HEREIN.** Hoover's liability for damages to you for any costs whatsoever arising out of this statement of limited warranty shall be limited to the amount paid for this product at the time of original purchase and Hoover shall not be liable for any direct, indirect, consequential, or incidental damages arising out of the use or inability to use this product.

Some states do not allow the exclusion or limitation of incidental or consequential damages, disclaimers of implied warranties, or limitations on the duration of implied warranties, so the above

exclusions, disclaimers, and/or limitations may not apply to you. This warranty gives you specific legal rights, and you may also have other rights, which vary from state to state.

**Warning**

This content is compiled from multiple sources and is provided for reference purposes only. It may not be complete or fully applicable to all situations. If you are unable to resolve your issue, please contact the product manufacturer or an authorized service provider for official support.

---

Document generated by [ManualsFile](#)

