

Installation

This dryer must be installed by a qualified installer. If service is required due to poor or faulty installation, it is considered the owner's responsibility and may void the warranty. Keep these instructions for future reference.

WARNING

- Do not plug the power cord into a wall outlet before the dryer is completely installed.
- Have two or more persons help move the dryer.
- Do not let children or pets play in, on, or around the dryer. Proper supervision is necessary at all times.
- Keep all packaging materials away from children.
- Do not replace a damaged power cord or power plug yourself. Have Samsung or a qualified service technician replace a damaged power cord or power plug.
- Do not attempt to repair, disassemble, or modify the dryer. For any repairs, contact the nearest Samsung service centre.
- Remove the door/lids from all discarded appliances to avoid children from suffocating.
- If the dryer generates a strange noise, burning smells, or smoke, unplug the power plug immediately and contact the nearest Samsung service centre.
- Do not unplug the dryer while it is operating.
- Do not place flammable objects near the dryer

WARNING

Remove the door from all discarded appliances to prevent a child from suffocating.

Location

Select a level, the well-constructed surface that will withstand vibrations. Select a location where a grounded, 3-prong outlet is easily accessible.

WARNING

- Install the dryer indoors only.
- Do not install the dryer in areas exposed to the weather.
- Do not install the dryer where the temperature may fall below 5 °C or rise above
- Do not install the dryer where gas may leak.
- Do not block the cooling grill's air inlet located at the dryer front.

Alcove or closet installations

For alcove or closet installation, the dryer requires the following minimum clearances:

Sides	Top	Front	Rear
25 mm	25 mm	490 mm	51 mm

If installing the dryer with a washer, the front of the alcove or closet must have an unobstructed air opening of at least 490 mm.

Electrical and grounding requirements

- The dryer requires an AC 220-240 V / 50 Hz electrical supply.
- The dryer must be properly grounded. If the dryer malfunctions or breaks down, grounding reduces the risk of electric shock by providing a path of least resistance for the electric current. The dryer comes with a power cord that has a 3-prong grounding plug. The plug must be plugged into an appropriate outlet that is properly installed and grounded in accordance with all local codes and ordinances.
- If you have any questions regarding the electrical or grounding requirements, please contact Samsung or a qualified electrician.

WARNING

- Plug into a grounded, 3-prong outlet.
- Do not use a damaged power plug, cord, or loose or damaged wall outlet.
- Do not use an adaptor or an extension cord.
- Improper connection of the equipment-grounding conductor may result in electric shock. If you are unsure if the dryer is properly grounded, check with a qualified electrician.
- Do not modify the power plug, power cord, or power outlet in any way.
- Do not connect the ground wire to plastic plumbing lines, gas lines, or hot water pipes.

Levelling

Before you install the dryer, make sure you have read Installation requirements on page 20. Please note that the following instructions are for installation without using a drain hose. For instructions for using a drain hose, see the next section, Drain hose (if necessary). For convenience, consider installing the dryer next to your washer.

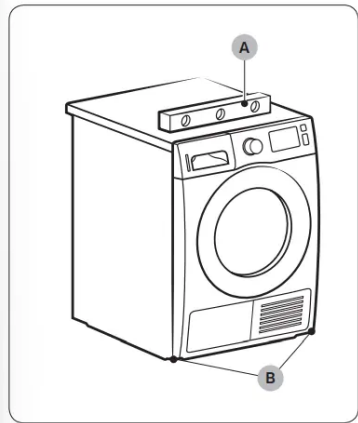

1. Gently slide the dryer into the desired location.
2. Use a level (A) and check the levelness of the dryer from side to side and front to back.
3. If the dryer is not level, adjust the levelling leg (B). Turning the leg counter-clockwise retracts the leg. Turning the leg clockwise extends the leg.
4. Once the dryer is level, make sure the dryer stands firmly on the floor.
5. Plug in the dryer.

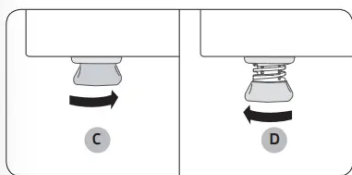

NOTE

- The dryer can be levelled using either or both of the front and rear legs of the dryer.
- To set the dryer to the same height as the washer, fully retract (C) the levelling legs by turning them counter clockwise, then loosen (D) the legs by turning them clockwise.
- Extend the levelling leg only as much as necessary. Extending the levelling leg more than necessary can cause the dryer to vibrate.

Drain hose (if necessary)

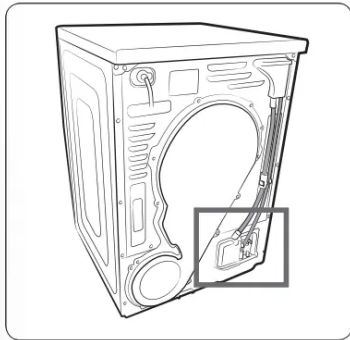

The dryer comes with a built-in water tank. However, if you do not want to use the water tank, you may install the drain hose. The provided accessory hose (long drain hose) can be used as an extension to the drain hose.

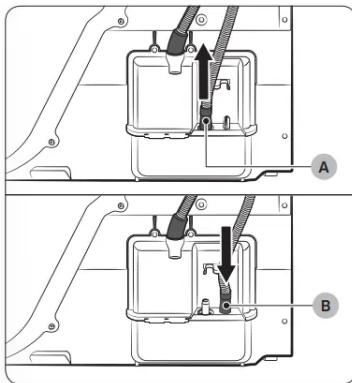

1. Remove the drain hose from hole (A), and insert it into hole (B).

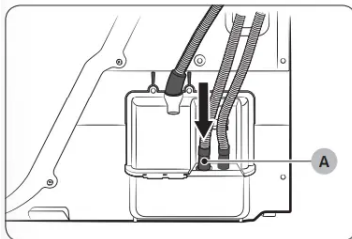

2. Insert one end of the accessory hose (long drain hose) into hole (A).
3. Insert the other end (outlet) of the accessory hose to the drainage system in one of the following ways:

Over a wash basin:

	<ol style="list-style-type: none"> 1. Make sure to place the end of the accessory hose lower than 90 cm (*) from the bottom of dryer. 2. To bend some point of the accessory hose, use the supplied plastic hose guide (B) and secure the guide to the wall with a hook or to the tap with a piece of string. Assemble the drain hose (A) and the hose guide (B) and fix them with the cable-tie (C). 3. You can drain the condensed water by connecting the accessory hose (long drain hose) to the drain-outlet directly
--	---

CAUTION

- Do not extend the drain hose. Water may leak from the connected area. Use a long drain hose.

By using the drain pipe of the wash basin:

	<ol style="list-style-type: none"> 1. Assemble the hose connector (A), and attach it to the end of the accessory hose as shown. <p>CAUTION</p> <ul style="list-style-type: none"> • To prevent water leak, make sure to connect the hose and the connector firmly.
	<ol style="list-style-type: none"> 2. Connect the hose adaptor directly to the drain pipe of the wash basin.

Door reversal

Type 1

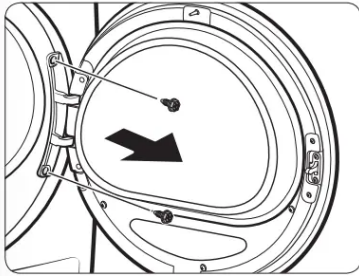

1. Open the door, and then remove the two screws on the door hinge. While holding the door with both hands, slightly lift to remove it.

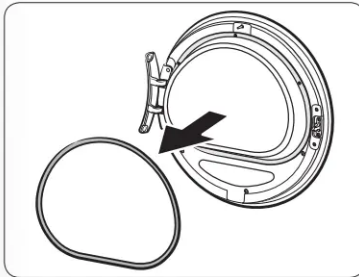

2. Use a thin object to remove the door sealing.

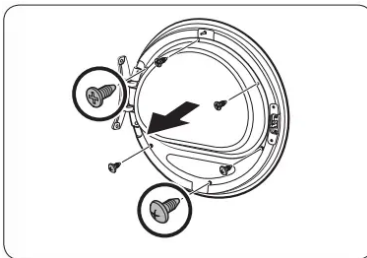

3. Remove the upper 3 screws and the lower 3 screws on the glass holder.

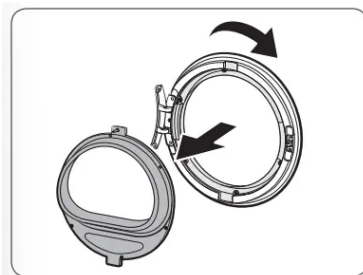

4. Remove the glass holder, and then rotate the door cover by 180 degrees.

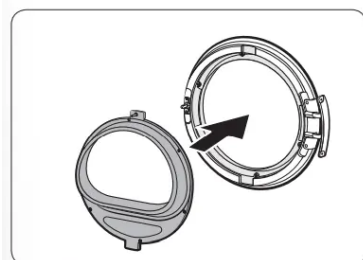

5. Insert the glass holder into the new position of the door cover. Make sure the door hinge is in the same position as in the figure.

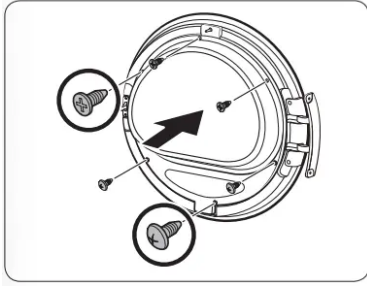

6. Tighten the upper 3 screws and the lower 3 screws on the glass holder.

NOTE The screw shapes differ by dimension. Make sure you tighten the correct screw.

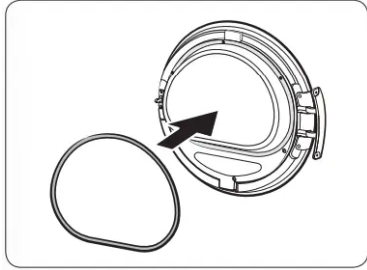

7. Insert the door sealing in the correct position.

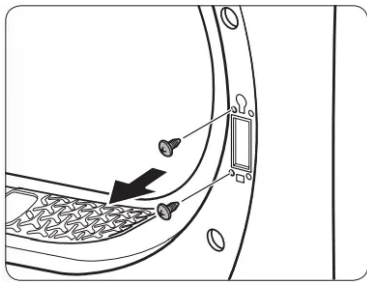

8. Remove the 2 screws that remain after removing the door hinge.

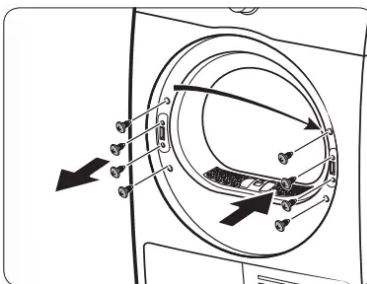

9. Remove the 4 screws on the door lock. Remove the door lock, and then reinsert it to the opposite side.

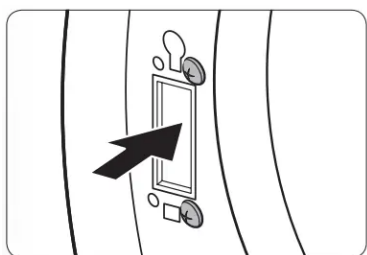

10. Tighten the 2 screws that were removed from step 8 on the hinge frame at the opposite side. Note that you must tighten them on the right (top-right and bottom-right) of the frame.

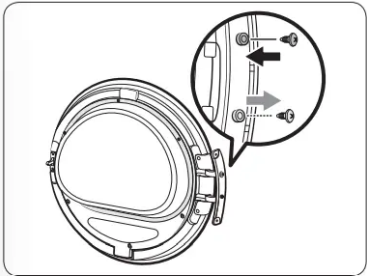
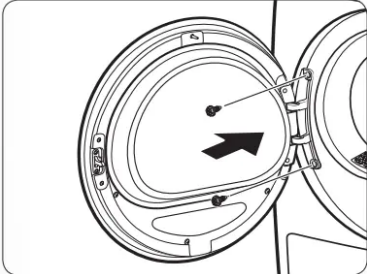
	<p>11. Remove the screw on the bottom of the door hinge, and the fasten it on the top of the door hinge.</p>
	<p>12. Put the door hinge on the opposite side, and then tighten the 2 screws to fix the door to the dryer.</p>
<p>NOTE To return the door to the initial position, follow the steps again. Please note that the door, hinges, and other parts would be in the opposite orientation as listed in these steps.</p>	

Before you start

Sort and load

- Put one wash load in the dryer at a time.
- Do not mix heavy and lightweight items together.
- To improve drying efficiency for one or two items, add a dry towel to the load.
- For best results, untangle items before inserting them into the dryer.
- Overloading reduces the tumbling action, resulting in uneven drying and wrinkling.
- Unless recommended on the care label, do not dry woolens or fiberglass items.
- Avoid drying unwashed items.
- Do not dry items soiled with oil, alcohol, gasoline, etc.

Functional prerequisite

Lint filter

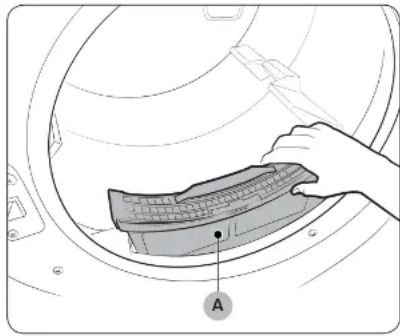

To prevent a risk of fire, make sure to clean the lint filter before or after every load.

1. Turn off the dryer.
2. Open the door, and pull out the lint filter (A) from inside the tumbler.
3. Open the lint filter by separating it at the top. Remove the lint that has accumulated, and then clean the lint filter.
4. Close the lint filter, reinsert the lint filter into the dryer, and then close the dryer door.

CAUTION

- Do not operate the dryer without the lint filter in place.
- Do not use a damaged or broken lint filter. This may reduce performance and/or cause fire.

Rack Dry (applicable models only)

Some models come with a drying rack which is inserted into the drum at the factory.

If your model came with a drying rack, remove the rack from the drum before you use the dryer for the first time. To remove the rack, pull the rack straight up, and then take it out of the drum.

Remove the drying rack from its packaging and store the rack for later use.

If a drying rack is not provided, you can purchase it at a local Samsung service center. (Part Code : DC61-02705A)

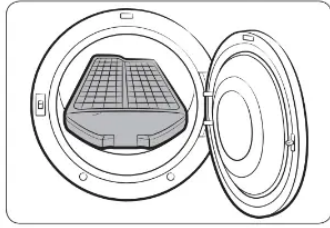

To use the drying rack, follow these steps:

1. Insert the drying rack (A) inside the tumbler with the filter handle to the front.
2. Insert the rear legs of the drying rack into the recessed areas of the rear wall, and then press down the middle of the drying rack to secure it in place.
3. Put items to dry on the rack. Make sure to leave space between the items for air flow.
4. Press Rack Dry, and then select the drying time.
5. When the items are dry, remove the them from the dryer, and then remove the drying rack.

Drying rack drying suggestions

Item	Cycle settings
Washable sweaters (block to shape and lay flat on rack)	TIME DRY with the Extra Low temperature setting
Stuffed toys (cotton or polyester fiber-filled)	
Stuffed toys (foam or rubber-filled)	AIR FLUFF
Foam rubber pillows	
Sneakers	

WARNING

Make sure to unpack the drying rack before using it. Otherwise, the dryer can be damaged or its performance diminished.







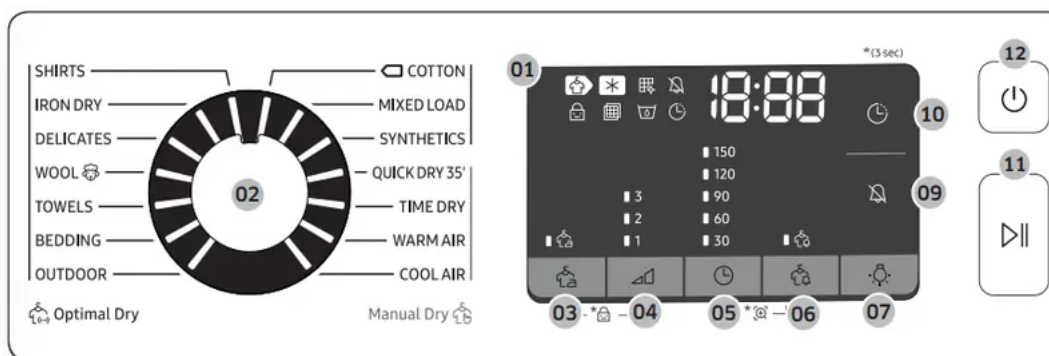

Drying foam rubber, plastic, or rubber on a heat setting may damage the items and create a fire hazard.

Feature panel

Control panel









<p>01 Digital Graphic Display</p>	<p>Displays all cycle information, including cycle time, information codes, and dryer status. See the table below for status details.</p> <table border="1" data-bbox="512 689 1225 1059"> <tr> <td></td> <td>Drying</td> <td></td> <td>Cooling</td> </tr> <tr> <td></td> <td>Heat-exchanger clean alarm</td> <td></td> <td>Sound on/off</td> </tr> <tr> <td></td> <td>Child Lock</td> <td></td> <td>Check filter alarm</td> </tr> <tr> <td></td> <td>Water Tank Full</td> <td></td> <td>Delay End</td> </tr> <tr> <td></td> <td>Wrinkle Prevent</td> <td></td> <td>Damp Alert</td> </tr> <tr> <td></td> <td>Smart Check</td> <td></td> <td></td> </tr> </table>		Drying		Cooling		Heat-exchanger clean alarm		Sound on/off		Child Lock		Check filter alarm		Water Tank Full		Delay End		Wrinkle Prevent		Damp Alert		Smart Check		
	Drying		Cooling																						
	Heat-exchanger clean alarm		Sound on/off																						
	Child Lock		Check filter alarm																						
	Water Tank Full		Delay End																						
	Wrinkle Prevent		Damp Alert																						
	Smart Check																								
<p>02 Cycle Selector</p>	<p>Turn the dial to select a cycle. See the Cycle overview on page 35 for available cycles.</p>																								
<p>03 Wrinkle Prevent</p>	<p>Adds approximately 3 hours of intermittent tumbling at the end of the selected cycle to reduce wrinkles. A large circle appears in display panel, and the drum rotates intermittently. To activate, press Wrinkle Prevent. The corresponding indicator lights up.</p>																								
<p>04 Drying Level</p>	<p>Press to select the dryness level in the SHIRTS, COTTON, MIXED LOAD, and SYNTHETICS cycles. The dryness can be set in three levels (1-3). Level 1 is used to partially dry items that lay flat or hang to dry. Level 3 is the strongest and is used to dry larger or bulk loads.</p>																								
<p>05 Time</p>	<p>Press to adjust the cycle time for TIME DRY, WARM AIR, and COOL AIR cycles.</p> <p>The following time options (unit: minute) are available: 30, 60, 90, 120, and 150.</p> <ul style="list-style-type: none"> 120 minutes and 150 minutes are not available for WARM AIR and COOL AIR cycles. The exact drying time differs depending on the humidity of the load. 																								

06  Damp Alert	This alarm is available only with SHIRTS, COTTON, MIXED LOAD, and SYNTHETICS cycle. If a load contains mixed fabrics, the Damp Alert indicator () blinks when the average dryness of the item is 80 % dry. This lets you take items that you don't want fully dried or that dry quickly out of the dryer early while letting others continue to dry.
07  Lamp (DV9*TA*****/ DV8*TA*****)	Press to turn on or off the interior lamp. The lamp stays lit for 2 minutes after it has turned on, and then turns off automatically.
08  Smart Check (DV7*TA*****)	If the dryer has detected an issue, Smart Check allows you to check the status of the dryer using a smart phone.
09  Sound On/ Off	Press to mute/unmute the alarm. The sound setting is retained when you turn the dryer off and turn it on again.
10  Delay End	You can adjust the finish time of the selected cycle in 1-hour increments all the way up to 24 hours.
11  Start/Pause (Hold to Start)	Press to start or pause a cycle. If the dryer is running, press the button once to pause the dryer. Press again to resume.
12  Power	Press to turn the dryer on/off. If the dryer turns on for 10 minutes without any button being pressed, the dryer automatically turns off.

Getting started

Simple steps to start

1. Press Power to turn the dryer on.
2. Load the dryer and close the door.
3. Turn the Cycle Selector to select a cycle.
4. Change the cycle settings ( Drying Level, and  Time) as necessary.
5. Select necessary settings and options to your preference. ( Wrinkle Prevent,  Lamp, Damp Alert, and/or  Delay End).
6. Press and hold  Start/Pause (Hold to Start). The dryer indicator lights up, and the estimated cycle time appears on the display.

NOTE The number of available settings and options differs with the cycle.

To change the cycle during operation





1. Press Start/Pause (Hold to Start) to stop operation.
2. Select a different cycle.
3. Press and hold Start/Pause (Hold to Start) to start new cycle.

Sorting and loading

- Put only one wash load in the dryer at a time.
- Avoid mixing heavy and lightweight items together.
- To increase drying efficiency when drying one or two items, add a dry towel to the load.
- For best results, untangle items before inserting into the dryer.
- Overloading restricts the tumbling process, resulting in uneven drying and wrinkling.
- Unless recommended on the care label, avoid drying woollens or fibreglass items.
- Avoid drying unwashed items.
- Do not dry items soiled with oil, alcohol, gasoline, etc.

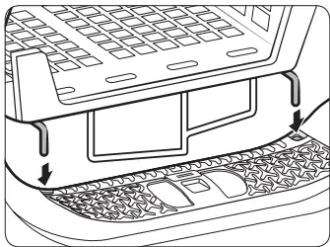
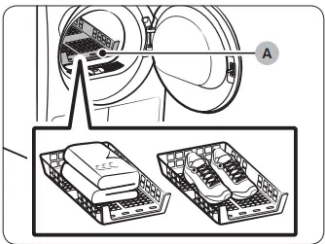
Rack Dry (applicable models only)

Set the drying time up to 150 minutes according to the moisture and weight of the items to dry. When drying laundry using the drying rack, the TIME DRY cycle is recommended.

	<p>1. Position the drying rack in the drum, inserting the front lips of the rack into the holes of the door diaphragm.</p>
 <p>A. Rack dry</p>	<p>2. Place items on the rack, leaving enough space where air can circulate. For clothing items, fold and place flat on the rack. For shoes, place shoes with their soles facing down.</p> <p>3. Close the door and press  Power. Select TIME DRY, and then press  Time to select the drying time.</p> <p>4. Press and hold  Start/Pause (Hold to Start).</p>

Drying suggestions

Items (max 1.5 kg)	Description
Washable sweaters (block to shape and lay flat on rack)	When drying the laundry using the rack, fold and place the clothes on the rack to prevent the clothing from becoming wrinkled.
Stuffed toys (cotton or polyester fibre filled)	
Stuffed toys (foam or rubber-filled)	
Foam rubber pillows	
Sneakers	To dry sports shoes, place the shoes on the rack so that the soles of the shoes are facing downwards.



CAUTION

- Drying foam rubber, plastic, or rubber on a heat setting may cause damage to the items and lead to a fire hazard.
- To prevent damage to shoes, use Rack Dry.

Special features

Child Lock

Child Lock prevents children from playing with the dryer. When Child Lock is activated, all buttons except for the POWER button are disabled.

To activate/deactivate Child Lock, simultaneously press and hold  Damp Alert and Smart Control or  Wrinkle Prevent and  Drying Level for 3 seconds.



NOTE

- If Child Lock is activated, and the dryer is turned off and then on again, Child Lock remains activated.

Smart Check

If the dryer has detected an issue, Smart Check allows you to check the status of the dryer using a smartphone. Please note that Smart Check can only be used for Galaxy and iPhone series

smartphones. To use Smart Check, make sure you have downloaded the Samsung Smart Washer/Dryer app, and then follow the steps below.

1. Press and hold  Time and  Damp Alert for 3 seconds or press Smart Check. The LED's on the display panel rotate, and the Smart Check code is displayed.
2. On the smartphone, open the Samsung Smart Washer/Dryer app and tap the Smart Check button.
3. Focus the smartphone's camera on the Smart Check code shown on the display panel.
4. If the information code is recognised, the app provides detailed information for the issue and further instructions.

NOTE

- If the dryer reflects light on the display, the smartphone may fail to recognise the information code.
- If the smartphone fails to recognise the code, manually enter the information code into the smartphone.

Maintenance

WARNING

- Do not clean the dryer by directly spraying water onto the dryer.
- Do not clean the dryer with benzene, thinner, alcohol, or acetone. This may cause discoloration, deformation, damage, electric shock, or fire.
- Before cleaning the dryer, be sure to unplug the power cord.

Control panel

Clean with a soft, damp cloth. Do not use abrasive cleaners. Do not spray cleaners directly on the panel. Immediately wipe up any spills or liquids from the control panel.

Exterior

Clean with a soft, damp cloth. Do not use abrasive cleaners. Avoid using or placing sharp or heavy objects near/on the dryer. Keep detergent and laundry supplies on the pedestal (sold separately) or in a separate storage container.

Drum

Clean with a damp cloth with a mild, non-abrasive cleaner suitable for stainless steel. Wipe remaining residue with a clean, dry cloth.

Lint filter

Clean the lint filter after each load.

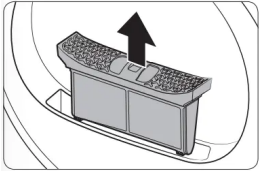
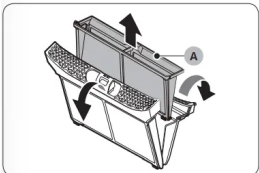
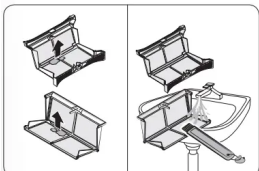
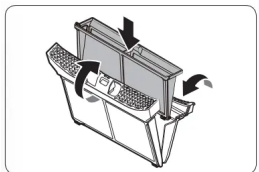
	<p>1. Open the door and pull the lint filter upward to remove.</p>
	<p>2. Open the outer filter and remove the inner filter (A).</p>
	<p>3. Unfold both the inner filter and the outer filter.</p> <p>4. Remove the lint from both filters, and then clean the filters with the cleaning brush.</p> <p>NOTE To clean the filters thoroughly, clean the filters in running water, and then dry them completely.</p>
	<p>5. Put the inner filter into the outer filter, and then reinsert the lint filter into the original position.</p>

- **CAUTION**

Clean the lint filter after each load. Otherwise, the drying performance may decrease.

- Do not operate the dryer without the inner filter inside the outer filter.
- Using the dryer with a wet lint filter may cause mold, bad odours, or a decrease in drying performance.

Water tank

To avoid leaks, empty the water tank after every load.

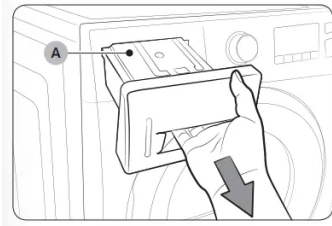

1. Using both hands, pull the water tank (A) forward to remove.

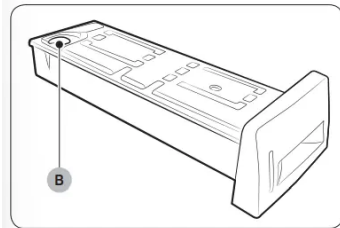

2. Empty the water through the drain hole (B) and place the water tank back into place.

NOTE If you empty the water tank and press and hold  Start/Pause (Hold to Start), the corresponding indicator turns off.

Heat exchanger

Clean the heat exchanger at least once a month. (or When the Buzzer rings and the heat exchanger indicator lights up on the display.)

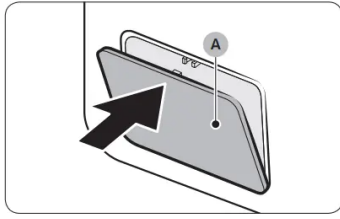

1. Gently press the top part of the outer cover (A) to open.

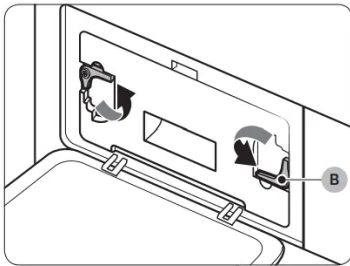

2. Unlock the fixers (B).

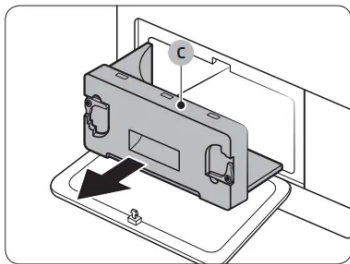

3. Remove the inner cover (C).

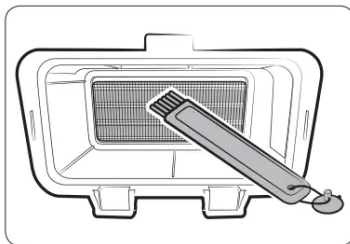

4. Clean the heat exchanger with the provided cleaning brush or a vacuum cleaner with a brush attachment. Take care not to bend or damage the heat exchanger fins when cleaning. This may lead to a decrease in drying performance.

CAUTION

- To avoid physical injury and burns, do not touch or clean the heat exchanger with bare hands.
- Do not use water to clean the heat exchanger.

5. Clean the inner cover with a smooth, damp cloth.

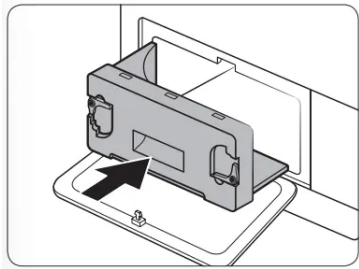
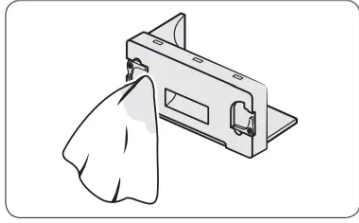

6. Reinsert the inner cover to its original position, and then lock the fixers.

7. Close the outer cover.

NOTE After cleaning, make sure the fixers are locked.

Troubleshooting

Symptom	Action
Dryer does not run	<ul style="list-style-type: none"> • Make sure the door is completely closed. • Make sure the power cord is plugged in. • Check the home's circuit breaker and fuses. • Empty the water tank. • Clean the lint filter.
Dryer does not heat	<ul style="list-style-type: none"> • Check the home's circuit breaker and fuses. • Select a heat setting other than COOL AIR. • Check the lint filter and heat exchanger. Clean them if necessary. • Dryer may be in the cool-down phase of the cycle.
Dryer does not dry	<p>Check the above, plus...</p> <ul style="list-style-type: none"> • Make sure the dryer is not overloaded. • Sort light and heavy items separately. • Reposition large, bulky items to ensure even drying. • Check that the dryer is draining properly. • For small loads, add a few dry towels. • Clean the lint filter and heat exchanger.
Dryer is noisy	<ul style="list-style-type: none"> • Check for coins, buttons, lighters, etc. • Make sure the dryer is level and standing firmly on the floor. • The dryer may hum due to air moving through the drum and fan. This is normal.
Dries unevenly	<ul style="list-style-type: none"> • Seams, pockets, and other parts of clothing are harder to dry than others. This is normal. • Sort heavy and light items separately.



Dryer emits an odour	<ul style="list-style-type: none"> • The dryer may draw household odours in from the surrounding air and then exhaust them. This is normal.
Dryer turns off before the load is dry	<ul style="list-style-type: none"> • Dryer load is too small. Add more items and restart the cycle. • Dryer load is too large. Remove items and restart the cycle.
Lint on clothes	<ul style="list-style-type: none"> • Make sure the lint filter is clean before every load. • Dry lint-producing items (fuzzy towels) separate from lint trappers, such as black linen pants. • Divide larger loads into smaller loads.
Items still wrinkled after Wrinkle Prevent	<ul style="list-style-type: none"> • Small loads of 1-4 items work best. • Load fewer items. Load similar type items.
Odours remain in items after COOL AIR	<ul style="list-style-type: none"> • Make sure to thoroughly wash items with strong odours.



Information codes

Information code	Meaning	Action
tC	Air temperature sensor issue	Clean the lint filter and/or heat exchanger. If this continues, call for service.
tC5	Compressor temperature sensor issue	Wait 2-3 minutes. Turn the power on and restart.
dC	Running the dryer with door open	Close the door and restart. If this continues, call for service.
HC	Compressor overheat	Call for service.
5C	Water tank full Drain pump is out of order	Empty the water tank, turn the power on, and restart. If this continues, call for service.
AC6	Check communications between the main and the inverter PBAs.	<ul style="list-style-type: none"> • Depending on the state, the dryer may automatically returns to normal operation. • Turn the dryer off and turn it on again. Then, restart the cycle. • If the information code continues to appear, call for service.
3C	Check the motor for operation.	<ul style="list-style-type: none"> • Try restarting the cycle. • If the information code continues to appear, call for service.
FIL+tEr (Buzzer rings)	Heat exchanger needs to be cleaned	Clean the heat exchanger.

Warning

This content is compiled from multiple sources and is provided for reference purposes only. It may not be complete or fully applicable to all situations. If you are unable to resolve your issue, please contact the product manufacturer or an authorized service provider for official support.

Document generated by [ManualsFile](#)