

SET UP & USE

PARTS & FEATURES

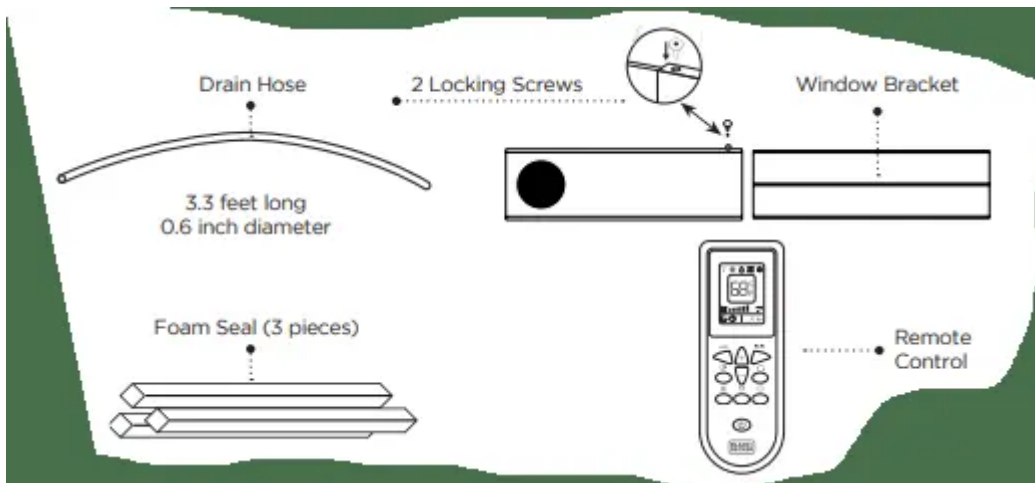
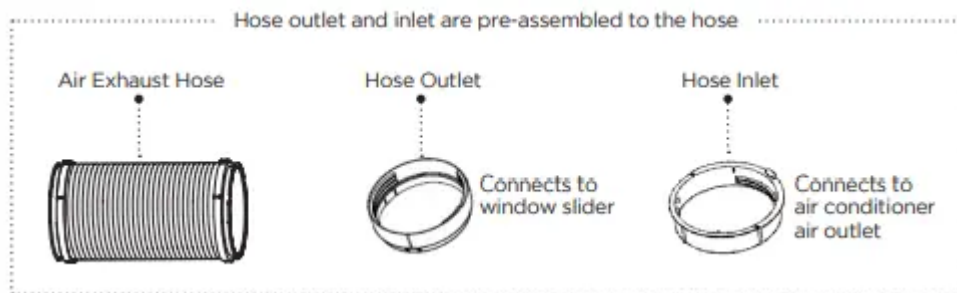
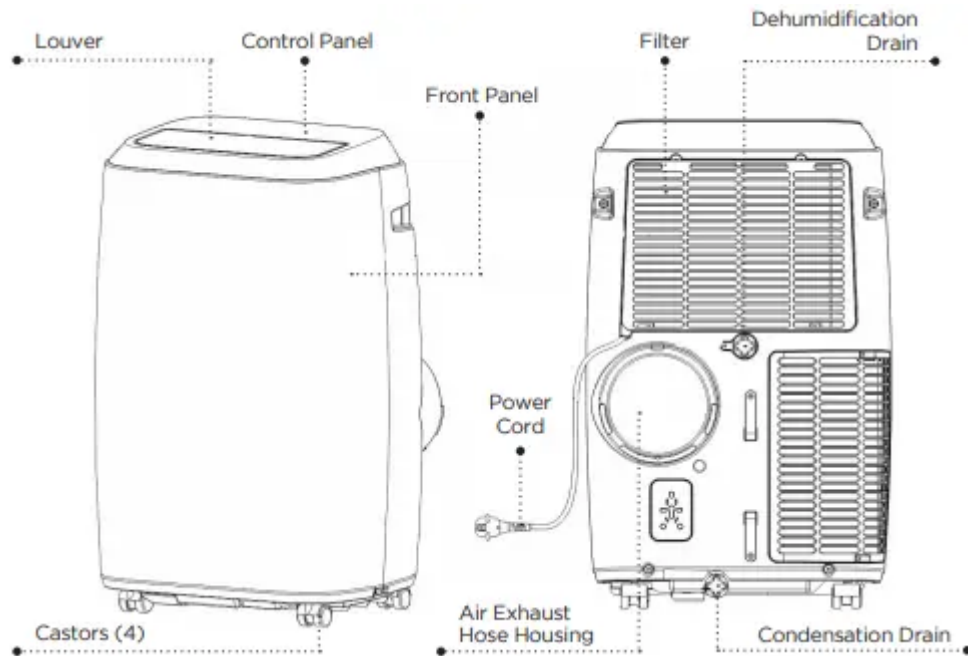

WINDOW SLIDER KIT INSTALLATION

Your window slider kit has been designed to fit most standard “Vertical” and “Horizontal” window applications; however, it may be necessary for you to improvise/modify some aspect of the installation procedures for certain types of window. Minimum and maximum window openings:

MAXIMUM: 47.2” (120 cm) **MINIMUM :** 27.5” (70 cm)

NOTE: Adjust the length of the window slider kit according to the window width or height, and secure it with the provided locking screws.

NOTE: If the window opening is less than 27.5” the minimum length of the window slider kit, cut the one with a hole in it short to fit for the window opening. Never cut out the hole in window slider kit.

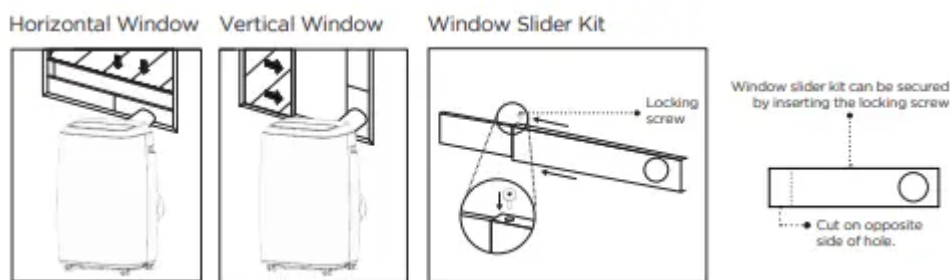

DOUBLE-HUNG SASH/SLIDING CASEMENT WINDOW INSTALLATION

1. Cut the foam seal (adhesive type) to the proper length and attach it to the window sash.
2. Attach the window slider kit to the window sash. Adjust the length of the window slider kit according to the width of window. Shorten the adjustable window kit if the width of window is less than 27.5”.
3. Cut the foam seal (adhesive type) to the proper length and attach it on the top of the window.
4. Close the window securely against the window slider kit.
5. Secure the window slider kit to the window sash.
6. Cut the foam seal to an appropriate length and seal the open gap between the top window frame and outer window frame.

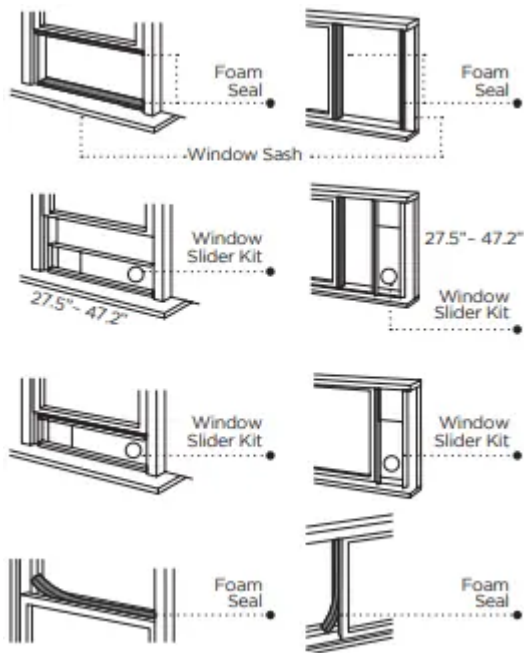

EXHAUST HOSE INSTALLATION

The air exhaust hose and hose inlet must be installed or removed from the portable air conditioner in accordance with the way it is being used:

COOL, DEHUMIDIFY, HEAT (Heat models BPP08HWTB and BPP10HWTB only: Air exhaust hose and hose inlet should be connected to the portable air conditioner.

FAN: Air exhaust hose and hose inlet should be disconnected from the portable air conditioner.

1. Connect hose inlet to one end of air exhaust hose. Push hose inlet over the end of the hose, push in slightly and then start threading it on in a clockwise direction. (see Fig. 1)

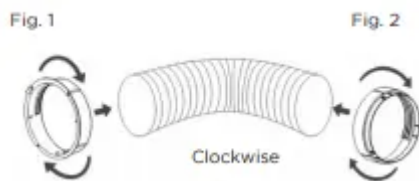

2. Connect hose outlet to other end of air exhaust hose. Push hose outlet over the end of the hose, push in slightly and then start threading it on in a clockwise direction. (see Fig. 2)

3. Align the tabs on the hose inlet into the slots over the air outlet, insert and push down. (see Fig. 3)

4. Insert the hose outlet into the window panel.

5. Affix the hose outlet into the window slider kit and seal. (Fig. 4 & 5)

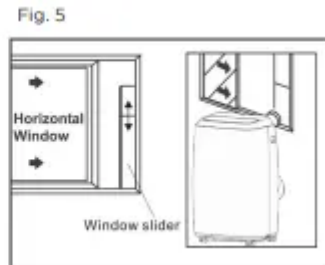
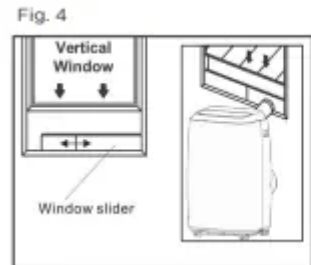
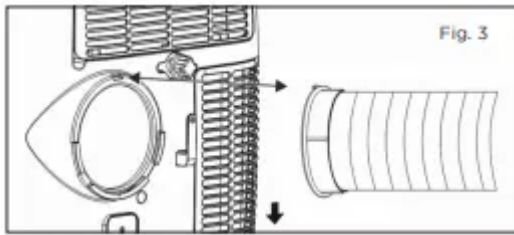

NOTE: The exhaust hose can be compressed or extended moderately, but it is desirable to keep the length to a minimum. Also make sure that the hose does not have any sharp bends.



CONTROL PANEL

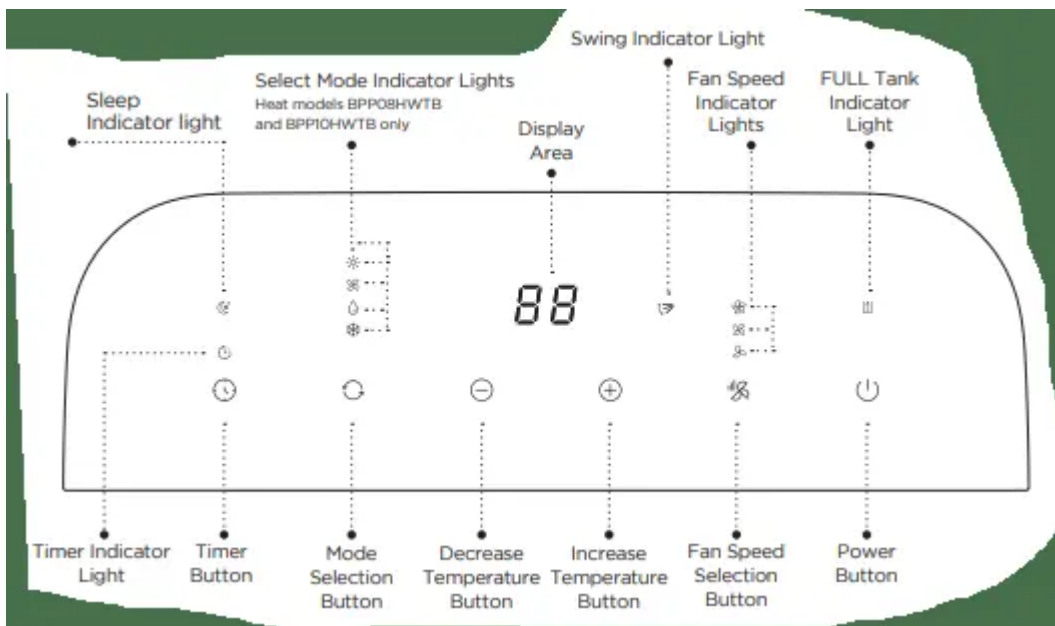



Pictures are for illustration purpose only. Your model may or may not have all the features.

OPERATING FROM THE CONTROL PANEL

The Control Panel enables you to manage all the main functions of the appliance, but to fully exploit its potential, you must use the remote control.

TURNING THE APPLIANCE ON

- Plug into the dedicated electrical outlet.
- Press the  button until the appliance comes on. The last function active when it was turned off will appear.
- Never turn the air conditioner off by unplugging from the outlet. Always press the button , then wait for a few minutes before unplugging. This allows the appliance to perform a cycle of checks to verify operation.

Note: Before pressing Power On button make sure the condensate drain plug in the rear of the unit is securely in place to avoid any leaking.

- Press the MODE  button until the light corresponding to the required Mode lights up.



COOL MODE ❄️



Fig. 7

Ideal for hot weather when you need to cool the room. To set operation of the appliance correctly, press the + or – buttons until the desired temperature is displayed. (See Fig. 7)

Then select the fan speed by pressing the Fan Speed Button until the light corresponding to the required fan speed lights up:

- ❁ HIGH: The Fan operates at maximum to reach the required temperature as rapidly as possible.
- ❁ MED: Reduces Fan noise level but still maintains cooling.
- ❁ MED: Reduces Fan noise level but still maintains cooling.

DEHUMIDIFY 💧

Press the “MODE” button until the “DEHUMIDIFY” indicator light comes on.

- Under this mode, you cannot select a fan speed or adjust the temperature. The fan motor operates at LOW speed.
- Keep window and door closed for the best dehumidifying effect.
- Exhaust hose attachment is not required to reduce humidity, however it is recommended in very humid rooms so the warm air can be exhausted outside.

DEHUMIDIFICATION MODE

- It is recommended that the dehumidification drain and drain hose can be used for continuous drainage.
- FULL TANK  - When the water level reaches a predetermined level, the “full tank” indicator light goes on. The unit will have to be drained.

NOTE: Refer to Water Drainage section.

FAN MODE

- Press the “MODE” button until the “FAN” indicator light comes on.
- Press the speed button to select HIGH, MEDIUM or LOW fan speed. The temperature cannot be adjusted.
- Exhaust hose attachment is not required in this mode.

HEAT MODE (Heat models BPP08HWTB and BPP10HWTB only)

Press the “MODE” button until the “HEAT” indicator light comes on.

- Press the + or – buttons to select your desired room temperature. The temperature can be set within a range of 61°F-88°F.
- Press the speed button to select HIGH, MEDIUM or LOW fan speed.

NOTE: At the beginning of this mode, you may have to wait a few seconds before the appliance starts to give out hot air.

TIMER

- To set the AUTO STOP timer. When the unit is ON, press the TIMER button.
- Press the + or – button to select the AUTO TIME by 1 hour increments, up to 24 hours. The LED Display will indicate the remaining time. Press the TIMER button again. The TIMER indicator light illuminates to show that the AUTO STOP program is initiated.
- To set the AUTO START timer. When the unit is OFF, press the TIMER button.
- Press the + or – button to select the AUTO TIME by 1 hour increments, up to 24 hours. The LED Display will indicate the remaining time. Press the TIMER button again. The TIMER indicator light illuminates to show that the AUTO START program is initiated.
- Pressing the POWER button or the TIMER button will cancel the AUTO START/STOP timed program and the timer indicator light will not be illuminated.

SWING INDICATOR LIGHT

When this light is illuminated, it indicates that the air swing is activated from the remote and the louvers will move up and down.

SLEEP INDICATOR LIGHT

When this light is illuminated, it indicates that SLEEP has been activated from the remote control and that the temperature will gradually adjust.

OPERATING FROM THE REMOTE CONTROL

BATTERY INSTALLATION (BATTERIES NOT INCLUDED)

- (1) Slide open the battery compartment cover.
- (2) Insert 2 × “AAA” batteries as shown.
- (3) Slide back the battery cover.

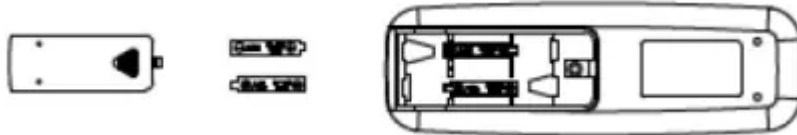

CAUTION: Use only AAA or IEC R03 1.5V alkaline batteries. Remove the batteries if the remote is not used for a month or longer. Do not attempt to recharge the batteries. Both batteries should be replaced at the same time. Do not dispose of the batteries in a fire as they may explode.

Point the remote control at the receiver on the appliance. The remote control must be no more than 7 meters away from the appliance (without obstacle between the remote control and the receiver).

The remote control must be handled with extreme care. Do not drop it or expose it to direct sun light or sources of heat.

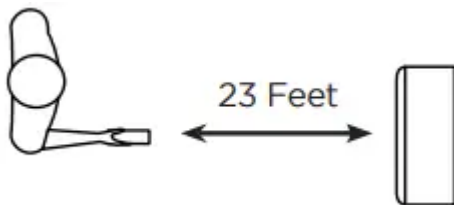

REMOTE CONTROL

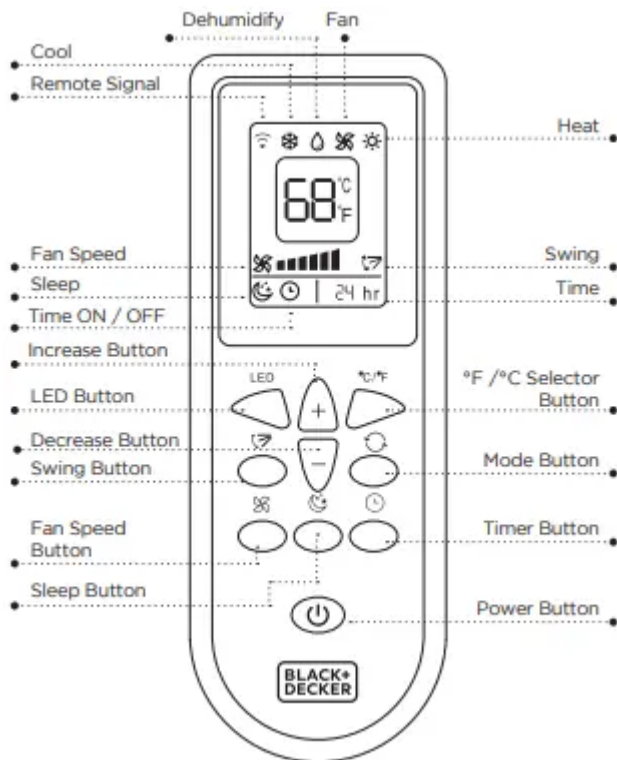

POWER BUTTON: Press to Turn ON or OFF

TIMER BUTTON: Used to set a delay start or shut down time.

MODE BUTTON: Each time you press the button COOL, DEHUMIDIFY, FAN, HEAT (models BPP08HWTB and BPP10HWTB is selected)

°C / °F SELECTOR BUTTON: Select Fahrenheit or Celsius.

INCREASE: Increase the temperature setting.

DECREASE: Decrease the temperature setting.

LED BUTTON: Illuminates the LED screen on the unit.

SWING BUTTON: Activates the air swing of the louvers.

FAN SPEED BUTTON: Used to select the HIGH, MED or LOW Fan speed.





SLEEP BUTTON: Gradually adjusts the temperature.

LED Display Indicators			
	Cooling mode		Fan speed
	Dehumidify mode		Swing
	Fan mode		Timer on
	Heat mode Heat models BPP08HWTB and BPP10HWTB only		Time
			Sleep
	Display temp. or hours		Fahrenheit or Celsius.

POWER BUTTON

- Press to Turn Air Conditioner ON or OFF. Press LED button to illuminate the LED screen on the unit.
-  Will show on the remote LED screen when buttons are pressed to show that the remote control is sending a signal to the air conditioner.

MODE BUTTON

- Press the mode button to scroll through COOL , DEHUMIDIFY , FAN , HEAT  (Heat models BPP08HWTB and BPP10HWTB only)
- The corresponding symbol will illuminate on the LED display to indicate which mode is selected.

COOL

- Select the target temperature 61°F – 88°F (16°C – 31°C) by pressing the + or – buttons until the desired temperature is displayed on the LED screen.
- Press the Fan Speed Button  to select Low, Medium, or High Speed.

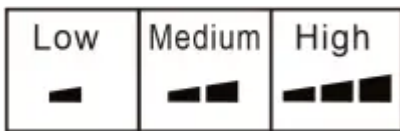

DEHUMIDIFY

Ideal for reducing humidity.

- Keep window and door closed for the best dehumidifying effect.
- Exhaust hose attachment is not required to reduce humidity, however it is recommended in very humid rooms so the warm air can be exhausted outside.

Draining in Dehumidify mode

- It is recommended that the dehumidification drain and drain hose be used for continuous drainage.
- FULL TANK - When the water level reaches a predetermined level, the “full tank” indicator light goes on. The unit will have to be drained.

NOTE: Refer to Water Drainage section.

- In this mode, fan speed is selected automatically by the appliance and can not be set manually.

FAN

- Press the Fan Speed Button  to select Low, Medium or High Speed.

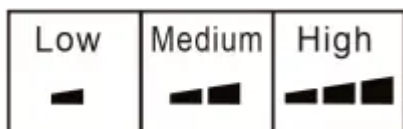

HEAT

Select the target temperature 61°F – 88°F (16°C – 31°C) by pressing the + or – buttons until the desired temperature is displayed on the LED screen.

Press the speed button to select HIGH, MEDIUM or LOW fan speed.

NOTE: At the beginning of this mode, you may have to wait a few seconds before the appliance starts to give out hot air.

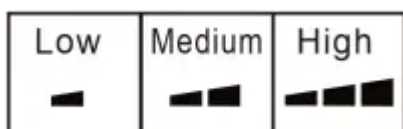

SWING

- Press this button to activate the air swing of the louvers. Press it again to deactivate.

TIMER

- To set the AUTO STOP timer. When the unit is ON, press the TIMER button. The TIME ON/OFF symbol on the remote LCD display will blink.
- Press the + or – button to select the AUTO TIME by 1 hour increments, up to 24 hours. The Remote LCD Display will indicate the selected time. Press the TIMER button again to set the selected time. There will be a steady TIME ON/ OFF symbol on the remote LCD display and the TIMER indicator light will be illuminated on the control panel of the unit to show that the AUTO STOP program is initiated.
- To set the AUTO START timer. When the unit is OFF, press the TIMER button. The TIME ON/OFF symbol on the remote LCD display will blink.
- Press the + or – button to select the AUTO TIME by 1 hour increments, up to 24 hours. The Remote LCD Display will indicate the selected time. Press the TIMER button again to set the selected time. There will be a steady TIME ON/ OFF symbol on the remote LCD display and the TIMER indicator light will be illuminated on the control panel of the unit to show that the AUTO START program is initiated.
- Pressing the POWER button or the TIMER button will cancel the AUTO START/ STOP timed program and the timer indicator light will not be illuminated

SLEEP

- The SLEEP function gradually adjusts the temperature of the rooms to provide a comfortable environment. Press the SLEEP button to activate.
- In COOL mode, the temperature will increase 1°F after an hour and 2°F after 2 hours.

- In HEAT mode, the temperature will decrease 1°F after an hour and 2°F after 2 hours.
- To cancel this setting press the SLEEP button again.

°C / °F SELECTOR BUTTON

- When the appliance is powered on, press the °C / °F button, then you can select the unit of temperature from Fahrenheit or Celsius.

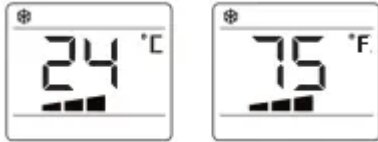

WATER DRAINAGE FOR COOLING AND HEAT MODES

This air conditioner is equipped with auto water evaporation so the water compartment would not typically fill in cooling or heating mode unless there is high humidity. Water drainage will generally only be required at the end of the season for these modes. (see START-END OF SEASON OPERATIONS).

NOTE: FULL TANK - When the water level reaches a predetermined level, the “full tank” indicator light located on the control panel of the unit goes on. If an error code appears on the display screen on the control panel “E2” in COOL mode or “E4” in HEAT mode. The unit will have to be drained.

Intermittent Draining

- Unplug the unit from the power source. Carefully move the unit to a drain area over your basement floor or drip pan (not included). Remove the bottom drain cap.
- Let the water drain away and replace the drain cap. Restart the machine until the error codes E2 or E4 disappears. If the error repeats, call for service.

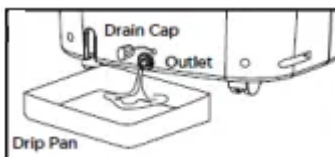

NOTE: Be sure to reinstall the bottom drain plug before using the unit.

Continuous Draining

- Unplug the unit from the power source. Remove the bottom drain cap. While doing this operation some residual water may spill so have a drip pan (not supplied) to collect the water.
- Connect the drain hose (supplied) as shown in the diagram. The water can be continuously drained through the hose into a floor drain or drip tray.
- Turn on the unit.

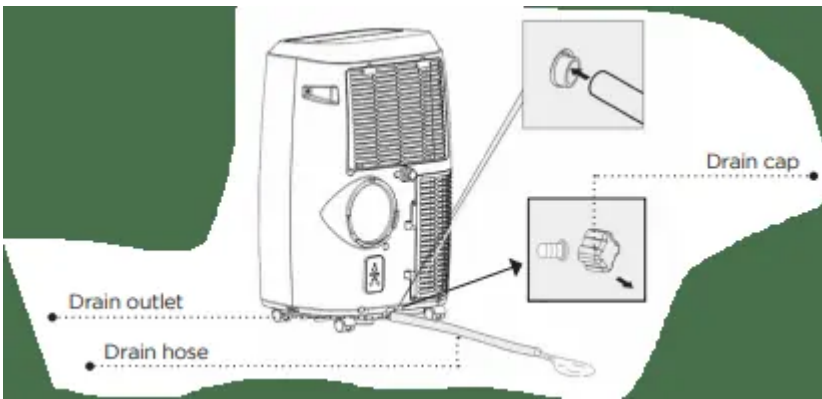

WAIT 3 MINUTES BEFORE RESUMING OPERATION

- After the unit has stopped, it cannot be restarted for 3 minutes. Operation will automatically restart after 3 minutes.

Continuous Draining for Dehumidification Mode

Unplug the unit from the power source.

Remove the drain cap located in the back center of the unit. While doing this operation some residual water may spill so have a drip pan (not supplied) to collect the water.

Connect the drain hose (supplied) as shown in the diagram. The water can be continuously drained through the hose into a floor drain or bucket.

Turn on the unit.

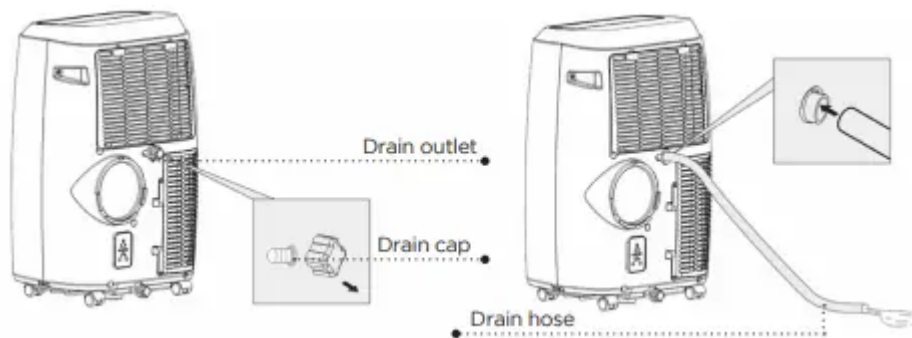



WAIT 3 MINUTES BEFORE RESUMING OPERATION

- After the unit has stopped, it cannot be restarted for 3 minutes. Operation will automatically restart after 3 minutes.

CLEANING & CARE

CLEANING

WARNING: Before cleaning or maintenance, turn the appliance off by pressing the  button on the control panel or  button on the remote control. Unplug from the electrical outlet.

CLEANING THE CABINET

You should clean the appliance with a slightly damp cloth then dry with a dry cloth.

- Never saturate the air conditioner with water.
- Never use petrol, alcohol or solvents to clean the appliance.
- Never spray insecticide liquids or similar near the air conditioner.

CLEANING THE FILTER

To keep your air conditioner working efficiently, you should clean the evaporator filter every week of operation.

The filter is housed in the intake grill.

Use a vacuum cleaner to remove dust accumulations from the filter. If it is very dirty, immerse in warm water and rinse a number of times. The water should be luke warm. After washing, leave the filter to dry then re-insert the filter.

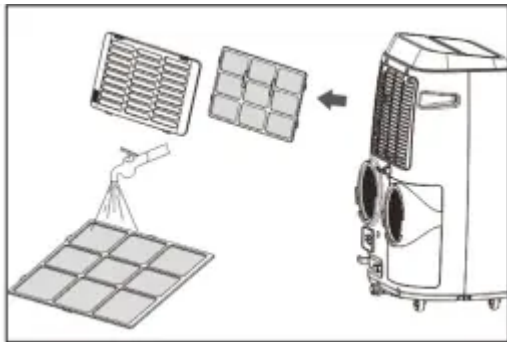

START - END OF SEASON OPERATIONS

START OF SEASON CHECKS

Make sure the power cable and plug are undamaged.

Follow the installation instructions precisely.

END OF SEASON OPERATIONS

See Water Drainage section to make sure the air conditioner is completely drained of water.

Clean the filter and dry thoroughly before reinstalling.

TROUBLESHOOTING & WARRANTY

Troubleshoot your problem by using the chart below. If the air conditioner still does not work properly, contact BLACK+DECKER customer service center or the nearest authorized service center. Customers must never troubleshoot internal components.

Unit does not start when pressing ON/OFF button

A. Water full indicator light is on. LED display indicates “E2” in COOL mode or “E4” in HEAT mode.

- A. Drain the water
- B. Room temperature is lower than set temperature (cooling mode)
 - B. Reset the temperature

Not cool enough

- A. The windows or doors in the room are not closed
 - A. Make sure all the windows and doors are closed
- B. There are heat sources inside the room
 - B. Remove the heat sources if possible
- C. Exhaust air duct is not connected or blocked
 - C. Connect the duct and make sure it can function properly
- D. Temperature setting is too high
 - D. Decrease the set temperature
- E. Air filter is blocked by dust
 - E. Clean the air filter
- F. The unit will take approx 3 minutes of operation before cooling occurs.
 - F. A microprocessor control delays the compressor from operating until 3 mins have passed.

Noisy or vibration

- A. The surface is not level or not flat enough
 - A. Place the unit on a flat, level surface if possible

Unit does not run and water full indicator light is on. LED display indicates “E2” in COOL mode or “E4” in HEAT mode.

- A. The unit needs to be drained.
 - A. Refer to water drainage section.

LED display “E0” , “E1” , “E3”

- A. E0 - Room temperature sensor issue
- B. E1- Condenser temperature sensor
- C. E3- Evaporator temperature sensor

Contact the Customer Satisfaction Center for assistance with error code.

Remote is not working

- A. Nothing Appears on the LED screen.

A. Press the LED button on the remote. If it does not illuminate, change batteries.

B. The temperature and symbols appear on the LED screen but the selection cannot be changed.

B. Make sure the remote is being pointed at the remote control receiver on the unit within 23 feet away and that there are no obstructions.

Warning

This content is compiled from multiple sources and is provided for reference purposes only. It may not be complete or fully applicable to all situations. If you are unable to resolve your issue, please contact the product manufacturer or an authorized service provider for official support.

