

Familiarising yourself with your appliance

Familiarise yourself with the parts of your appliance.

Appliance

You can find an overview of the parts of your appliance here.

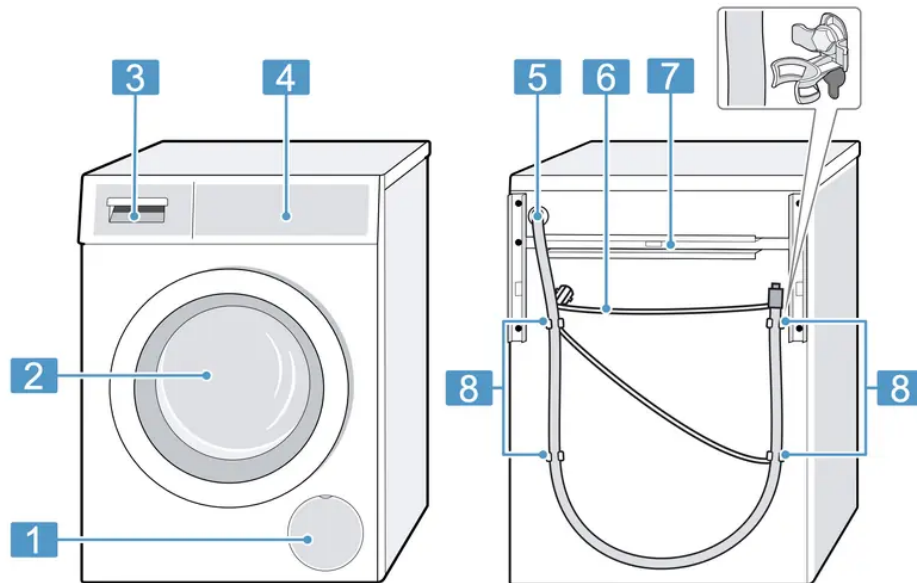

1. Maintenance flap for the drain pump
2. Door
3. Detergent drawer
4. Controls
5. Water outlet hose
6. Power cord
7. Transport struts
8. Transit bolts

On certain models, specific details such as the colour and shape may differ from those pictured.

Detergent drawer

Below is an overview of the structure of the detergent drawer.

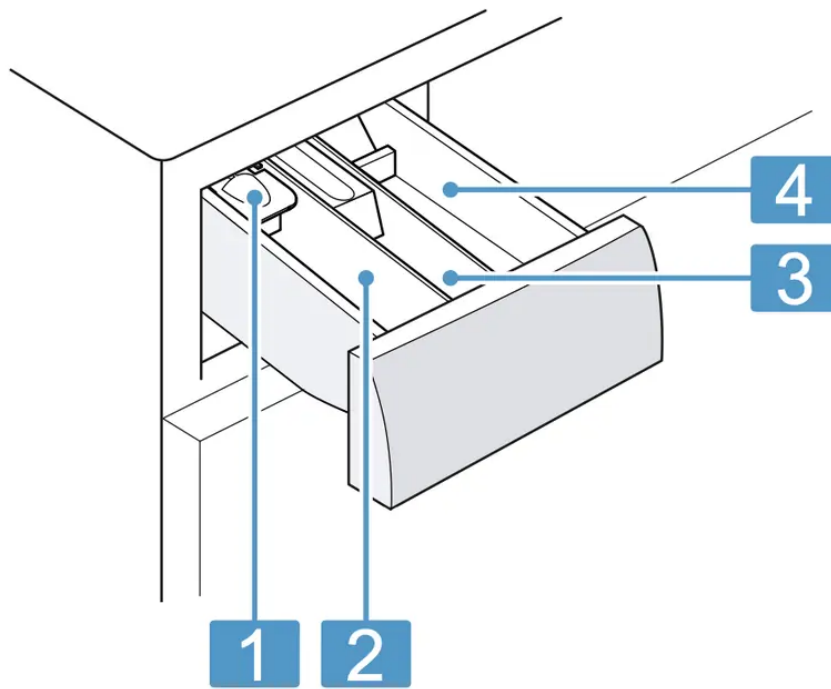

1. Measuring aid for liquid detergent
→ "Using a measuring aid for liquid detergent"
2. Compartment II:
Detergent for main wash
Water softener
Bleach
Stain remover
3. Compartment :
Fabric softener
Liquid starch
Waterproofing agent
4. Compartment I:
Detergent for prewash
Hygiene detergent

Controls

The controls are used to configure all functions of your appliance and to obtain information about the operating status.

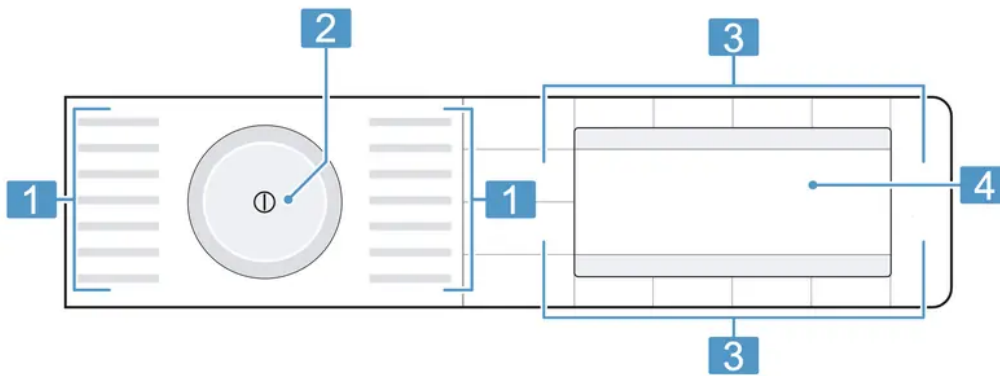

1. Programmes
2. Programme selector
3. Buttons
4. Display

Operating logic

In addition to the actual functions of the buttons on the display, you can also use these buttons to select programme settings in the main menu and settings in the sub-menus. The buttons are then marked by symbols in the display.

Main menu

To select programme settings, press the buttons above or below the symbols.

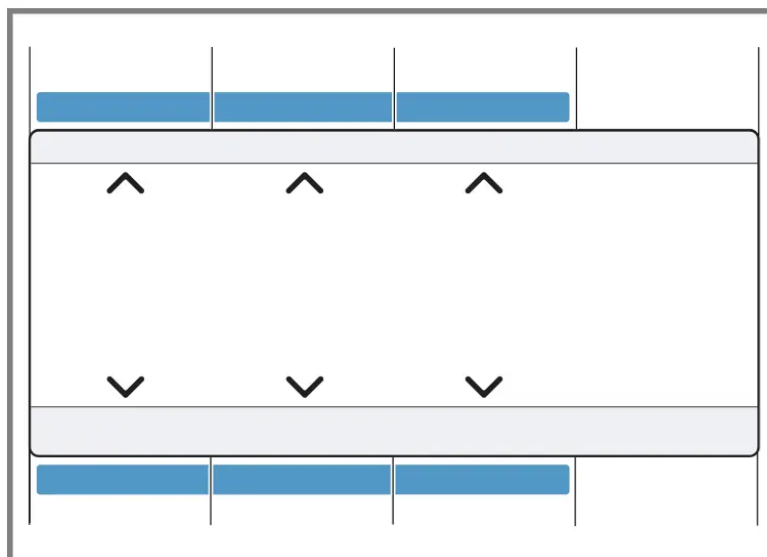

The selected programme setting is shown in the middle of the display.

Sub-menu

To select the settings you require, press the buttons below the symbols until the required setting is selected in the display.

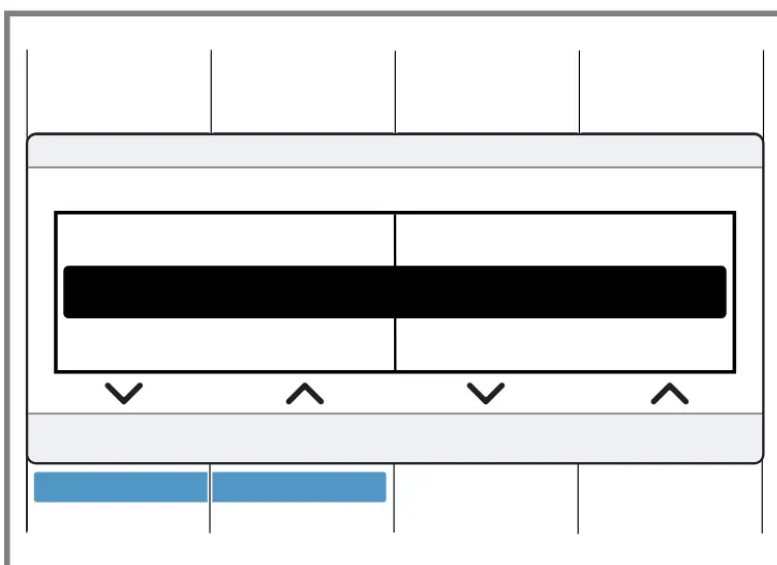

To select the settings you require, press the buttons below the symbols until the required setting is selected in the display.

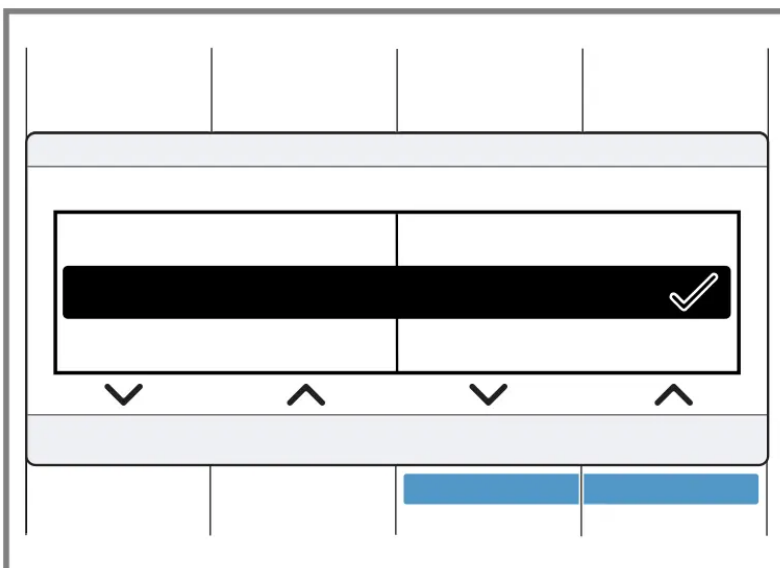

If a setting is activated, the display shows . The selection does not need to be confirmed again. The submenu closes automatically after a few seconds.





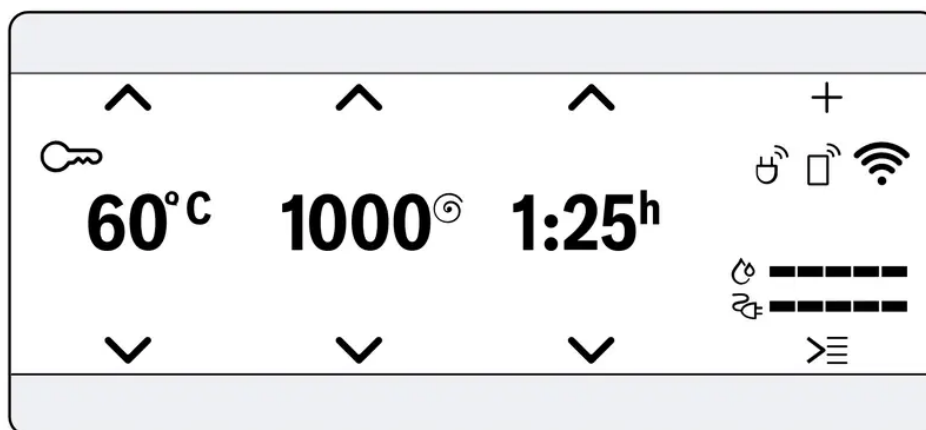



















Display

The display shows the current settings, options or relevant information.









Display	Designation	Description
0:40 h ¹	Programme duration/ programme time re- maining	Approximate expected programme duration or pro- gramme time remaining.
10h ¹	"Ready in" time	The programme end has been set and the remaining number of hours is displayed. → "Buttons", Page 26
10 kg ¹	Recommended load	The maximum load capacity for the selected pro- gramme in kg.
0 - 1600 [⊙]	Spin speed	Set spin speed in rpm. → "Buttons", Page 26 0: No spin cycle, draining only
* - 90 °C	Temperature	Set temperature in °C. → "Buttons", Page 26 * (cold)
∨ ^	Navigation	Selecting settings. → "Operating logic", Page 22
+	Other programme set- tings	Activate, deactivate or adjust other programme set- tings. → "Buttons", Page 27

¹ Example

Display	Designation	Description
	Saving the programme Other programmes	"Save a programme" → <i>Page 42</i> . Set "other programmes" → <i>Page 42</i> .
	Childproof lock	<ul style="list-style-type: none"> ■ Lights up: The childproof lock is activated. ■ Flashes: The childproof lock is active and the programme selector has been adjusted. → <i>"Deactivating the childproof lock", Page 46</i>
	Easy Iron	The reduced creasing function is activated. → <i>"Buttons", Page 28</i>
	Extra Rinse	Additional rinse cycles are activated. → <i>"Buttons", Page 27</i>
	Prewash	Prewash is activated. → <i>"Buttons", Page 27</i>
	Water Plus	Wash with more water is activated. → <i>"Buttons", Page 28</i>
	Soaking	Soaking is activated. → <i>"Buttons", Page 28</i>
	Rinse Hold	Rinse Hold is activated. → <i>"Buttons", Page 27</i>
	Silent Wash	Silent Wash is activated. → <i>"Buttons", Page 28</i>
	Baby food	The stain type is activated.
	Blood	The stain type is activated.
	Egg	The stain type is activated.
	Strawberry	The stain type is activated.
	Soil and sand	The stain type is activated.
	Grass	The stain type is activated.
	Coffee	The stain type is activated.
	Cosmetics	The stain type is activated.
	Orange	The stain type is activated.
	Red Wine	The stain type is activated.
	Chocolate	The stain type is activated.
	Sweat	The stain type is activated.
	Dirty socks	The stain type is activated.
	Grease and oil	The stain type is activated.
	Tea	The stain type is activated.
	Tomato	The stain type is activated.

¹ Example



Display	Designation	Description
	Energy consumption	Energy consumption for the selected programme. <ul style="list-style-type: none"> ■ — : Low energy consumption ■ ———— : High energy consumption
	Water consumption	Water consumption for the selected programme. <ul style="list-style-type: none"> ■ — : Low water consumption ■ ———— : High water consumption
	Remote start	Remote start is activated. → "Buttons", Page 27
	Wi-Fi	<ul style="list-style-type: none"> ■ Lights up: The appliance is connected to your home network. ■ Flashes: The appliance is trying to connect to your home network. → "Home Connect ", Page 46
	Wi-Fi	The appliance is not connected to your home network. → "Home Connect ", Page 46
	Energy manager	The appliance is connected to the smart energy system (energy manager). → "Connecting the appliance to the energy manager", Page 48
Dosage: 50% ¹	Dosing recommendation	The recommended dosage for detergent. → "Detergent dosage", Page 41 Note: The dosing recommendation indicates the load capacity that should be used for the relevant detergent dosage. The percentage refers to the maximum load capacity for the programme.





¹ Example

Buttons

Below is an overview of the buttons and their setting options. With the Options button, you can open the sub-menu for additional programme settings. The additional programme settings are listed in the overview for the buttons.

The selection of programme settings depends on the selected programme. You can see the selection options for each programme in the overview for → "Programmes".

Button	Selection	Description
Start/Reload ▷	<ul style="list-style-type: none"> ■ Start ■ Cancel ■ Pause 	Start, cancel or pause the programme.
SpeedPerfect	<ul style="list-style-type: none"> ■ Activate ■ Deactivate 	<p>Activate or deactivate a short washing programme.</p> <p>Note: Energy consumption increases. The washing result is not affected by this.</p>
Intensive Plus 	<ul style="list-style-type: none"> ■ Activate ■ Deactivate 	<p>Activate or deactivate an extended washing programme.</p> <p>The programme duration is extended by up to 30 minutes.</p> <p>Suitable for heavily soiled laundry.</p>
AntiStain	Multiple selection	<p>Select the type of stain.</p> <p>The temperature, drum movement and soaking time are all adjusted to suit the type of stain.</p>
Finish in	1–24 hours	<p>Set the programme end.</p> <p>The programme duration is already included in the set number of hours.</p> <p>Once the programme has started, the programme duration is displayed.</p>
Temperature	 – 90 °C	Adjust the temperature in °C.
Spin Speed	0 – 1600 rpm	<p>Adjust the spin speed or deactivate the spin cycle.</p> <p>If 0 is selected, the water is drained and the spin cycle is deactivated at the end of the washing cycle. The laundry stays wet inside the drum.</p>
 (mains switch)	<ul style="list-style-type: none"> ■ Switch on ■ Switch off 	Switch the appliance on or off.

Button	Selection	Description
Remote Start 	<ul style="list-style-type: none"> ■ Activate ■ Deactivate ■ Open the Home Connect menu 	<p>If you briefly press the button, the appliance will be enabled for remote start via the Home Connect app</p> <p>If you press the button for approx. 3 seconds, the Home Connect menu opens.</p> <p>Notes</p> <ul style="list-style-type: none"> ■ For safety reasons, remote start cannot be activated if the door is open. ■ Remote start is deactivated for safety reasons in the following circumstances: <ul style="list-style-type: none"> – Open the door. – Press Start/Reload . – Press Remote Start . – Switch off the appliance. – Following a power cut.
Child Lock push 3 sec.	<ul style="list-style-type: none"> ■ Activate ■ Deactivate 	<p>Activate or deactivate the childproof lock. Disable the control panel to prevent unwanted or accidental operation.</p> <p>If the childproof lock is activated and the appliance has been switched off, the childproof lock remains activated.</p> <p>→ "Childproof lock", Page 46</p>
 3 sec.	"Basic settings" → Page 51	Change the basic settings for the appliance. → "Changing the basic settings", Page 52
Options	Multiple selection	Activate additional programme settings. → "Adjusting additional programme settings", Page 42 The additional programme settings can be found in this overview.
Pre-wash	<ul style="list-style-type: none"> ■ Activate ■ Deactivate 	Activate or deactivate prewash, e.g. for washing heavily soiled laundry.
Rinse Plus	<ul style="list-style-type: none"> ■ Activate ■ Deactivate 	Activate or deactivate up to three additional rinse cycles. Recommended for particularly sensitive skin or in regions with very soft water.
Rinse Hold	<ul style="list-style-type: none"> ■ Activate ■ Deactivate 	Activate or deactivate spinning and draining at the end of the washing cycle. The laundry remains in the water after the last rinse cycle. → "Resuming the programme when the programme status is Rinse Hold", Page 45

Button	Selection	Description
Silent Wash	<ul style="list-style-type: none"> ■ Activate ■ Deactivate 	Activate or deactivate Silent Wash, e.g. for washing during the night. The audible signal at the end of programme is deactivated and the final spin speed is reduced.
Water Plus	<ul style="list-style-type: none"> ■ Activate ■ Deactivate 	Wash with more water. Recommended for particularly sensitive skin and for treating laundry more gently.
Soak	<ul style="list-style-type: none"> ■ Activate ■ Deactivate 	Activate or deactivate soaking. Before the main wash cycle starts, the laundry remains in the water for longer. For laundry with particularly stubborn soiling.
Less Ironing	<ul style="list-style-type: none"> ■ Activate ■ Deactivate 	Activate or deactivate the reduced creasing programme. In order to reduce creasing in the laundry, the spin cycle and the spin speed are adapted. The laundry is damp enough after washing that it needs to be hung out on a washing line.

Programmes



Below is an overview of the programmes. You can find information on the load and on the adjustable programme options.

Tip: The laundry's care labels provide you with additional information on programme selection.

→ " Care symbols on the care labels "

Programme	Description	Max. load (kg)	Max. temperature (°C) ¹	Max. spin speed (rpm) ¹	SpeedPerfect	AntiStain	Rinse Plus	Rinse Hold	Pre-wash	Silent Wash	Soak	Water Plus	Less Ironing	Intensive Plus [®]
Cottons	Wash hard-wearing items made from cotton, linen or blended fabrics. Also suitable as a short programme for normally soiled laundry when you activate SpeedPerfect. If SpeedPerfect is activated, the maximum load capacity is reduced to 5 kg.	10	90	1600	●	●	●	●	●	●	●	●	●	●
Cotton Colour	Wash hard-wearing items made from cotton, linen or blended fabrics. Energy-saving programme.	10	90	1600	–	●	●	●	●	●	●	●	●	–

¹ Programme setting

Programme	Description	Max. load (kg)	Max. temperature (°C) ¹	Max. spin speed (rpm) ¹	SpeedPerfect	AntiStain	Rinse Plus	Rinse Hold	Pre-wash	Silent Wash	Soak	Water Plus	Less Ironing	Intensive Plus [®]
	Note: To save energy, the actual washing temperature may deviate from the set washing temperature. The washing performance meets legal requirements.													
Eco 40-60	Wash items made from cotton, linen or blended fabrics. Suitable for normally soiled items. Note: Textiles which can be washed as per the care symbol  at 40 °C or  at 60 °C can be washed together. In order to achieve the best possible energy efficiency, the optimum washing temperature for this programme was saved. The washing temperature is activated and cannot be changed.	10	-	1600	-	•	•	•	•	•	•	•	•	-
Easy Care	Wash items made from synthetic or blended fabrics.	4	60	1200	•	•	•	•	•	•	•	•	•	•

¹ Programme setting

Programme	Description	Max. load (kg)	Max. temperature (°C) ¹	Max. spin speed (rpm) ¹	SpeedPerfect	AntiStain	Rinse Plus	Rinse Hold	Pre-wash	Silent Wash	Soak	Water Plus	Less Ironing	Intensive Plus [®]
Mixed Load	Wash items made from cotton, linen, or synthetic or blended fabrics. Suitable for lightly soiled laundry.	4	60	1600	•	•	•	•	•	•	•	•	•	•
Delicates/Silk	Wash delicate, washable items made from silk, viscose and synthetics. Use a detergent that is suitable for delicates or silk. Note: Wash especially delicate items or items with hooks, eyelets or clips in a mesh laundry bag.	2	40	800	-	•	•	•	•	•	•	•	•	-
 Wool	Hand- or machine-washable items that are made from wool or contain wool. To prevent the laundry from shrinking, the drum moves the items very gently with long pauses. Use a detergent that is suitable for wool.	2	40	800	-	-	-	•	-	•	-	-	-	-

¹ Programme setting

Programme	Description	Max. load (kg)	Max. temperature (°C) ¹	Max. spin speed (rpm) ¹	SpeedPerfect	AntiStain	Rinse Plus	Rinse Hold	Pre-wash	Silent Wash	Soak	Water Plus	Less Ironing	Intensive Plus [®]
Additional Programs	Set additional programmes. The additional programmes can be found in this programme overview. The selectable programme settings depend on the selected programme.	-	-	-	-	-	-	-	-	-	-	-	-	-
Drain	Drains the water, e.g. when a programme is cancelled. Do not use fabric softener.	-	-	1600	-	-	-	-	-	-	-	-	-	-
Rinse/Freshen Up	Rinses and then spins the laundry, and then drains the water.	-	-	1600	-	-	●	●	-	-	-	●	●	-
Spin	Spins and drains the water. Do not use fabric softener.	-	-	1600	-	-	-	-	-	-	-	-	●	-
Easy Care Plus	Wash dark-coloured and colour-intense items made from cotton or easy-care fabric, e.g. jeans. Turn laundry inside-out before washing. Use liquid detergent.	4	40	1200	●	●	●	●	●	●	●	●	●	●

¹ Programme setting

Programme	Description	Max. load (kg)	Max. temperature (°C) ¹	Max. spin speed (rpm) ¹	SpeedPerfect	AntiStain	Rinse Plus	Rinse Hold	Pre-wash	Silent Wash	Soak	Water Plus	Less Ironing	Intensive Plus [®]
Drum clean	<p>Cleaning and caring for the drum. Use this programme in the following cases:</p> <ul style="list-style-type: none"> ■ Before using the appliance for the first time ■ If you regularly wash at temperatures of 40 °C or lower ■ After a prolonged period of non-use <p>Use washing powder or a detergent containing bleach. Halve the amount of detergent to avoid foaming. Do not use fabric softener. Do not use liquid detergent or detergent that is intended for woollens or delicates.</p> <p>Note: The drum cleaning indicator will flash to remind you if you have not used a programme at 60 °C or higher for a long time.</p>	-	-	1200	-	-	-	-	-	●	-	-	-	-

¹ Programme setting

Programme	Description	Max. load (kg)	Max. temperature (°C) ¹	Max. spin speed (rpm) ¹	SpeedPerfect	AntiStain	Rinse Plus	Rinse Hold	Pre-wash	Silent Wash	Soak	Water Plus	Less Ironing	Intensive Plus [®]
Memory	Save the programme you require and the customised programme settings. The selectable programme settings depend on the selected programme.	-	-	-	-	-	-	-	-	-	-	-	-	-
Nightwash Mix	Wash items made from cotton, linen, or synthetic or blended fabrics. Suitable for quiet washing at night. The audible signal at the end of the programme is deactivated and a reduced final spin speed set by default.	4	60	1600	●	●	●	●	●	-	●	●	●	●
AllergyPlus	Wash hard-wearing items made from cotton, linen or blended fabrics. Suitable for allergy sufferers and for strict hygiene requirements.	6,5	60	1600	●	●	●	●	●	●	●	●	●	●

¹ Programme setting

Programme	Description	Max. load (kg)	Max. temperature (°C) ¹	Max. spin speed (rpm) ¹	SpeedPerfect	AntiStain	Rinse Plus	Rinse Hold	Pre-wash	Silent Wash	Soak	Water Plus	Less Ironing	Intensive Plus [®]
	Note: Once the set temperature has been reached, it remains constant throughout the washing process.													
Towels	Hard-wearing items made from cotton or blended fabrics, e.g. towels and dressing gowns.	4	90	1600	●	●	●	●	●	●	●	●	●	●
Shirts	Wash non-iron shirts and blouses made from cotton, linen, synthetic fibres or blended fabrics. Tip: In order to avoid creasing in your laundry, you can activate Less Ironing. The laundry is only given a short spin and can be removed while still dripping wet. Hang out shirts and blouses while they are still dripping wet so that they drip dry. Use the Delicates/Silk programme to wash shirts and blouses made from silk or delicate fabrics.	2	60	800	-	●	●	●	●	●	●	●	●	●

¹ Programme setting

Programme	Description	Max. load (kg)	Max. temperature (°C) ¹	Max. spin speed (rpm) ¹	SpeedPerfect	AntiStain	Rinse Plus	Rinse Hold	Pre-wash	Silent Wash	Soak	Water Plus	Less Ironing	Intensive Plus [®]
Sportswear	Wash sports and leisure items made from synthetic fibres, microfibre or fleece. Use a detergent that is suitable for sports items. Do not use fabric softener. Tip: Use the Easy Care programme to wash heavily soiled laundry.	2	40	800	-	•	•	•	•	•	•	•	•	•
Super Quick 15'/30'	Wash items made from cotton, synthetic or blended fabrics. Short programme for small items of lightly soiled laundry. The programme duration is approx. 30 minutes. If you wish to reduce the programme duration to 15 minutes, activate SpeedPerfect. The maximum load is reduced to 2 kg.	4	40	1200	•	-	•	•	-	•	-	-	-	-

¹ Programme setting

Accessories

Only use original accessories. These have been made especially for your appliance. Here you can find an overview of your appliance's accessories and how to use them.

	Use	Order number
Water inlet hose extension	Extend the water inlet hose for cold water or AquaStop (approx. 2.50 m).	WMZ2381
Fixing brackets	Improves the stability of the appliance.	WMZ2200
Elbow	Secure the water outlet hose in place.	00655300
Liquid detergent insert	Measure liquid detergent.	00605740

Before using for the first time

Prepare the appliance for use.

Starting an empty washing cycle

Your appliance was inspected thoroughly before leaving the factory. To remove any residual water, run the first wash cycle without any laundry.

Note: Please read the information in the "Safety" and "Preventing material damage" sections to ensure that you use the appliance safely.

1. Press .

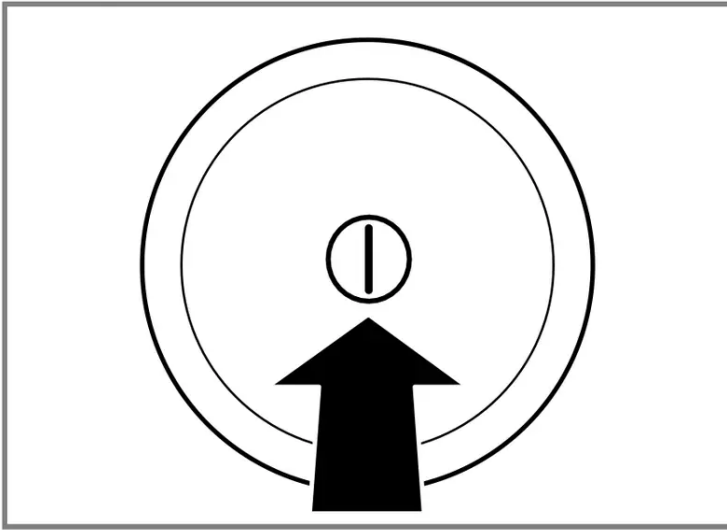

It may take a few seconds for the appliance to switch on.

2. Set the **Drum clean** programme.
3. Close the door.
4. Pull out the detergent drawer.

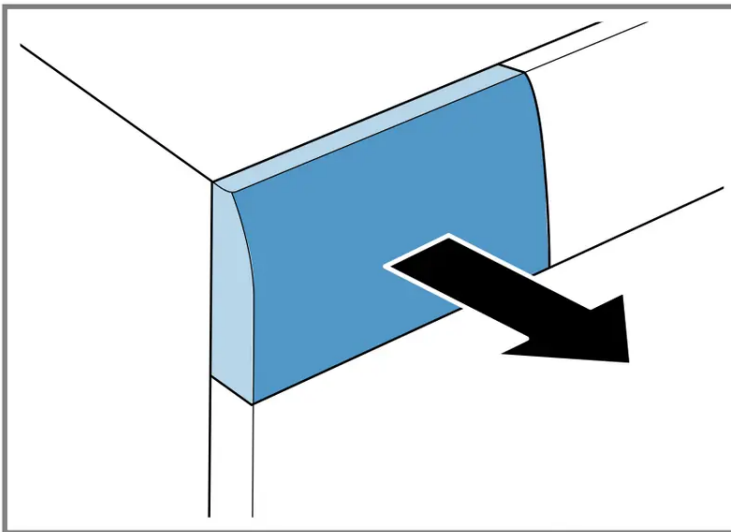

5. Pour approx. 1 litre of tap water into compartment II.

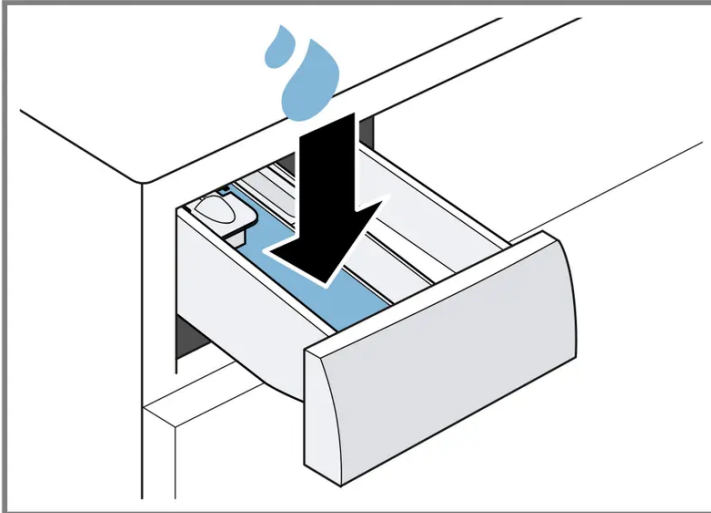

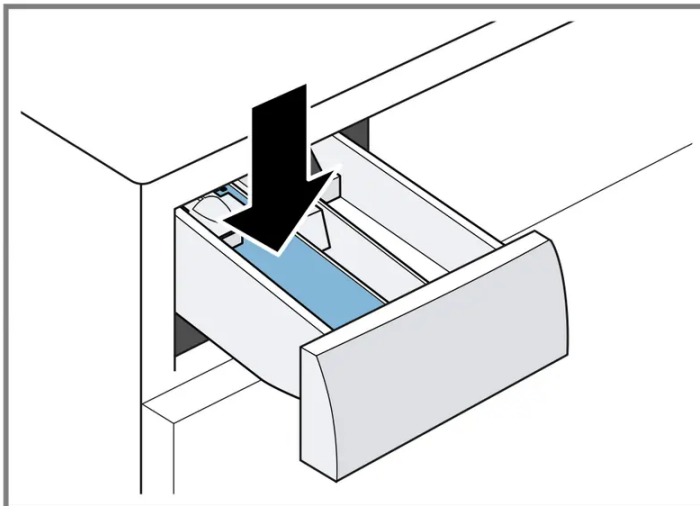

6. Pour washing powder into compartment II.

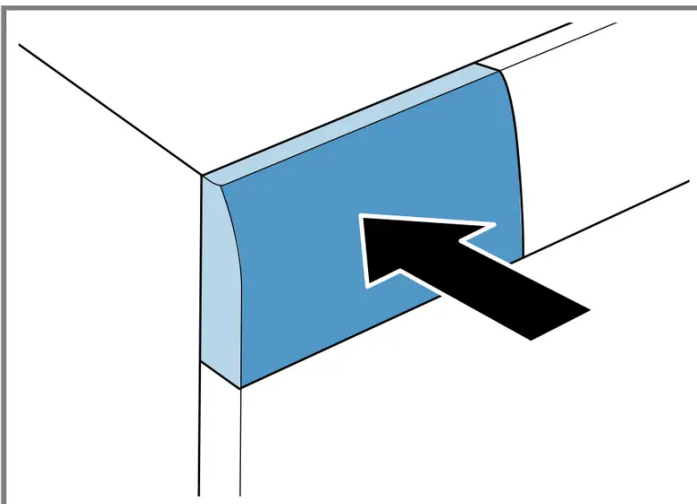

To prevent foaming, use only half of the amount of detergent recommended by the detergent manufacturer for light soiling. Do not use detergent suitable for woollens or delicates.

7. Push in the detergent drawer.



8. Press **Start/Reload**  to start the programme.
The display shows the remaining programme duration.
9. Start the first wash cycle or press  to switch off the appliance.
→ "Basic operation".

Laundry

You can wash all items that the manufacturer has marked as machine washable on the care label and fabrics made from hand-washable wool using your appliance.

Preparing the laundry

ATTENTION! Objects remaining in the laundry may damage the laundry and the drum.

- Remove all items from any pockets in your laundry before using the appliance.
- To protect your appliance and the laundry, prepare the laundry beforehand.
 - Empty all pockets
 - Brush sand out of all collars and pockets
 - Close bed covers and cushion covers
 - Close all zips, Velcro fasteners, hooks and eyes
 - Tie cloth belts and apron strings together or use a mesh laundry bag
 - Remove curtain hooks and lead strips or use a mesh laundry bag
 - Use a mesh laundry bag for small items of laundry such as children's socks
 - Separate items of laundry and shake them out
 - Wash large and small items of laundry together
 - Dab fresh stains with soapy water (do not rub them)
 - Some stubborn or dried-in stains can be removed by washing several times

Sorting laundry

Note: Please read the information in the "Safety" and "Preventing material damage" sections to ensure that you use the appliance safely.

- To improve washing results and prevent discolouration, sort the laundry according to the following criteria before washing.
 - Type of fabric and fibre type
 - Whites





- Colours
 - Wash new coloured items separately the first time you wash them.
- "Soiling"
- "Care symbols on the care labels"

Degrees of soiling

Degree of soiling	Soiling	Examples
Light	<ul style="list-style-type: none"> ▪ No dirt or stains are visible ▪ Laundry has absorbed odours 	Light summer clothing or sports clothing that has been worn for a just a few hours
Normal	Dirt or light stains are visible	<ul style="list-style-type: none"> ▪ T-shirts, shirts or blouses are sweat-soaked or have been worn a few times ▪ Towels or bedding that has been used for up to one week
Heavy	Dirt or stains are clearly visible	Tea towels, baby items or work clothing

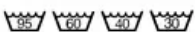
Care symbols on the care labels

The symbols indicate the recommended programme and the numbers in the symbols indicate the maximum recommended washing temperature.

Symbol	Washing process	Recommended programme
	Normal	Cottons
	Gentle	Easy Care
	Particularly gentle	Delicates/Silk for washing by hand
	Hand wash	Wool
	Not suitable for machine-washing	-

Detergents and care products

You can protect your appliance and your laundry by selecting and using the correct detergents and care products. You can use all detergents and care products which are suitable for domestic washing machines.

Note: Please read the information in the "Safety" and "Preventing material damage" sections to ensure that you use the appliance safely.

The manufacturer's instructions for use and dosage can be found on the packaging.

Notes

- Only use liquid detergents that are self-flowing

- Do not mix different liquid detergents
- Do not mix detergent and fabric softener
- Do not use products which have developed a top layer or are highly congealed
- Do not use products containing solvents, caustic agents or volatile substances (e.g. bleach)
- Use dyes sparingly as salt may damage stainless steel
- Do not use bleaching agents in the appliance

Detergent recommendation

This information helps you to choose the right detergent for your fabrics.

Detergent	Fabrics	Programme	Temperature
Standard detergent with optical brighteners	Heat-resistant white fabrics made from cotton or linen	Cottons	From cold up to 90 °C
Detergent for colours without bleach or optical brighteners	Coloured fabrics made from linen or cotton	Cottons	From cold up to 60 °C
Detergent for colours/delicates without optical brighteners	Coloured fabrics made from easy-care fibres or synthetic materials	Easy Care	From cold up to 60 °C
Detergent for delicates	Delicate fabrics made from silk or viscose	Delicates/Silk	From cold up to 40 °C
Detergent for woollens	Wool	Wool	From cold up to 40 °C

Detergent dosage

Use the correct detergent dosage to achieve optimal washing results and save resources.

The detergent dosage depends on:

- The amount of laundry
- Degree of soiling
- Water hardness You can find out how hard your water is from your local water company or measure it yourself using a water hardness tester.

Water hardness

Hardness range	Total hardness in mmol/l	German degrees in °dH
soft (I)	0-1.5	0-8.4
medium (II)	1.5- 2.5	8.4-14
hard (III)	over 2.5	over 14

Example of a manufacturer's instructions for detergent

These example values refer to a standard load of 4–5 kg.

Soiling	Light	Normal	Heavy
Water hardness: Soft/medium	40 ml	55 ml	80 ml
Water hardness: Hard/very hard	55 ml	80 ml	105 ml

The dosages can be found on the manufacturer's packaging.

- Adjust the dosage to the actual load.

Basic operation

You can find out everything you need to know about operating your appliance here.

Switching on the appliance

- Press .

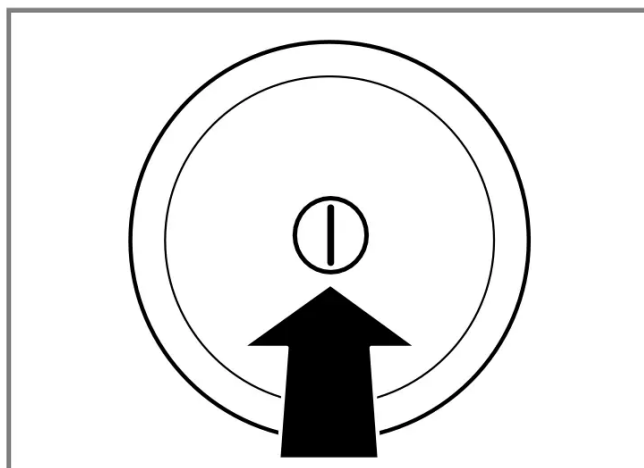

It may take a few seconds for the appliance to switch on.

Note: The drum is lit up after the door is opened and closed and once the programme has started. The light goes out automatically.

Setting a programme

1. Set the programme selector to the required "programme".

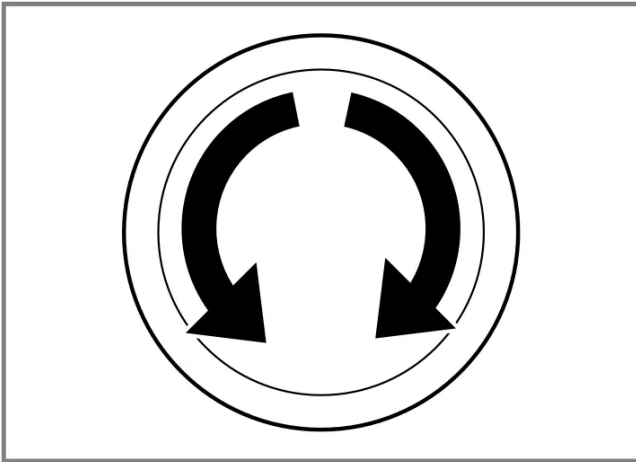

2. If necessary, "adjust the programme settings".

Setting additional programmes

1. Set the **Additional Programs** programme.
2. Press  to call up the sub-menu for additional programmes.

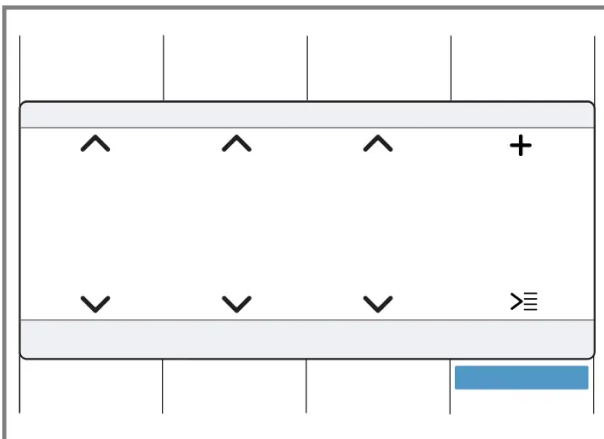

3. Select a programme.
4. Press **Main menu** to call up the main menu.
5. Adjust the programme settings if required.
6. Start the programme.

Adjusting the programme settings

Depending on the programme and programme progress, you can adjust or activate/deactivate the settings.

Note: Overview of all programme settings: → "Buttons"

Requirement: A programme has been set.

- Adjust the programme settings. → "Operating logic"

The programme settings are not saved permanently for the programme.

Adjusting additional programme settings

1. Press **Options** to call up the sub-menu for the additional programme settings.
2. Select the programme settings.
The programme settings are not saved permanently for the programme.
3. Press **Options** to call up the main menu.

Saving the programme settings

1. Set the **Memory** programme.
2. Press  to call up the sub-menu for the memory programmes.

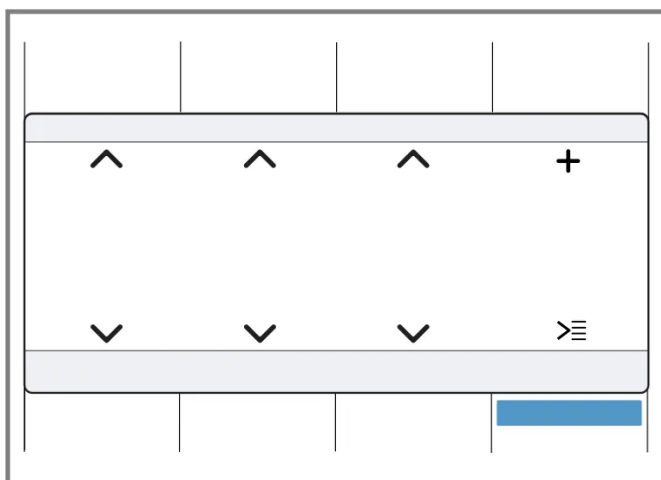

3. Select a programme.
4. Press Main menu to call up the main menu.
5. Adjust the programme settings if required.
The programme is saved.

Loading laundry

Notes

- Please read the information in the "Safety" and "Preventing material damage" sections to ensure that you use the appliance safely.
- To prevent creasing, take note of the maximum load for the relevant "programme"

Requirement: Prepare and sort the laundry. → "Laundry".

1. Open the door.

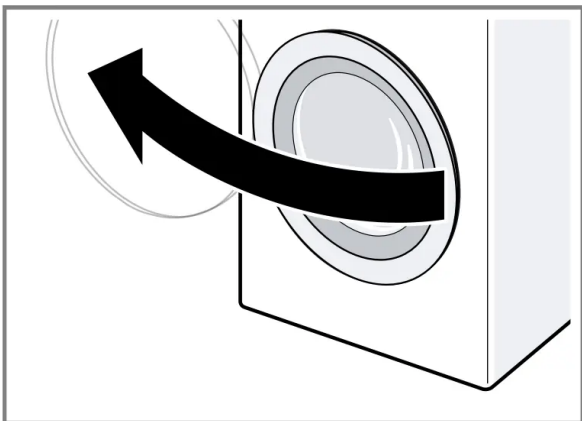

2. Ensure that the drum is empty.
3. Separate the laundry and place it in the drum.
4. **Note:** Ensure that there is no laundry trapped in the door. Close the door.

Using a measuring aid for liquid detergent

If you order the measuring aid as an accessory, you must use the measuring aid.

1. Pull out the detergent drawer.

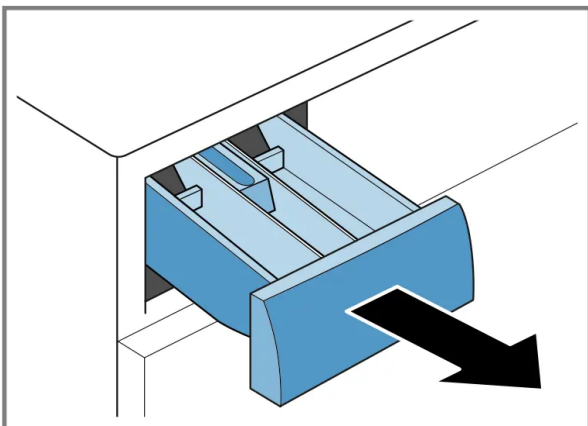

2. Press down on the insert and remove the detergent drawer.

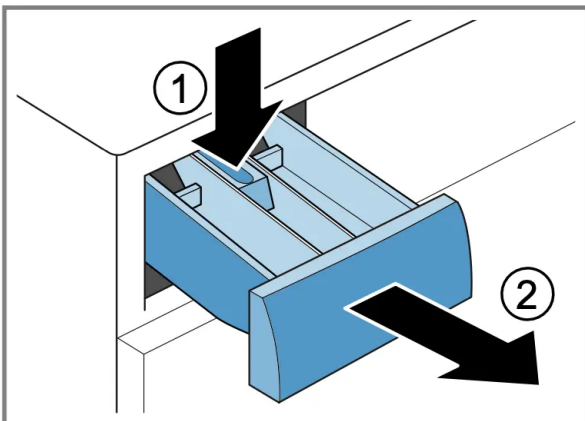

3. Insert the measuring aid.

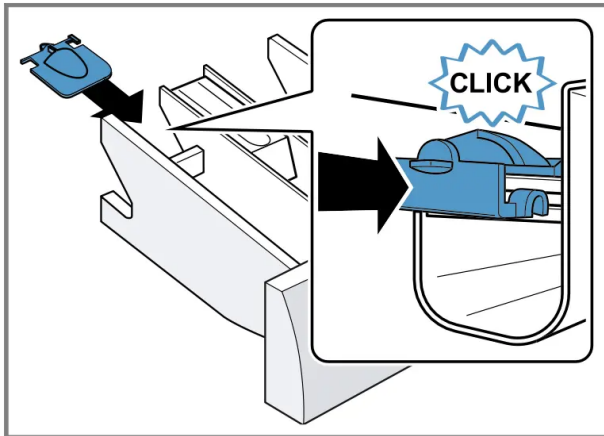

4. Insert the detergent drawer.

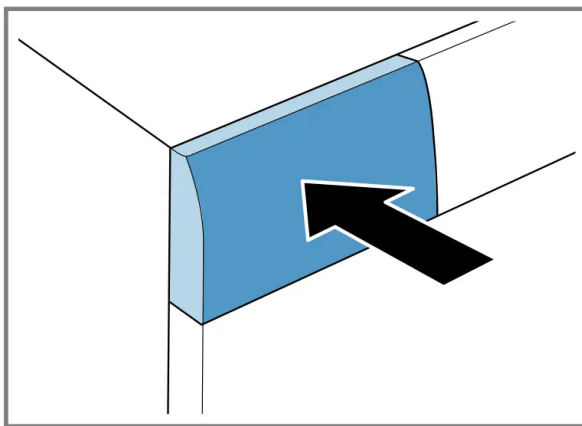

Use the measuring aid for liquid detergent

To add liquid detergent, you can use a measuring aid in the detergent drawer.

1. Pull out the detergent drawer.
2. Slide the measuring aid forwards.

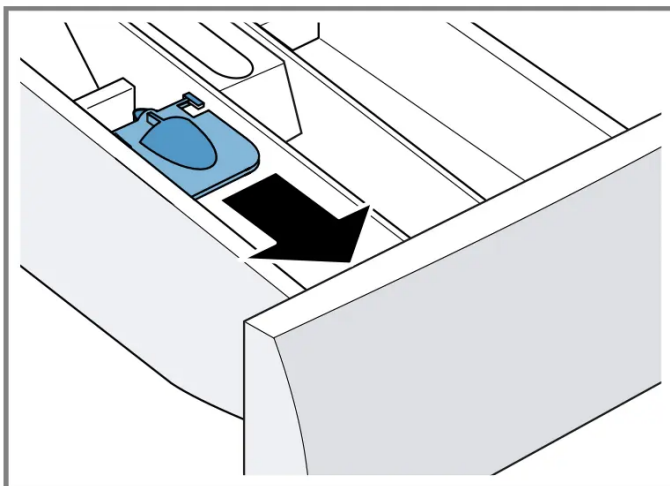

3. Fold the measuring aid down and click it into place.

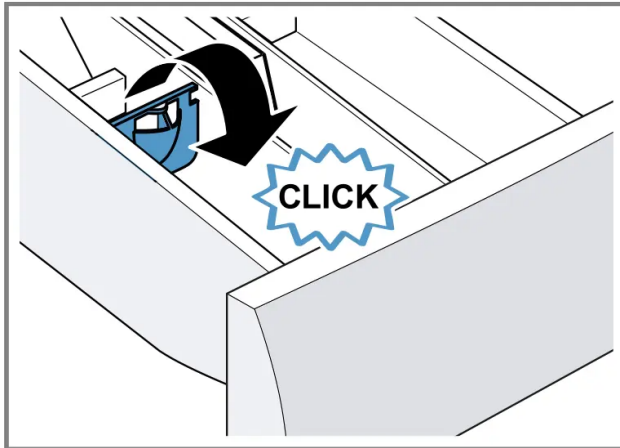

4. Push in the detergent drawer.

Adding detergent and care product

Notes

- Please read the information in the "Safety" and "Preventing material damage" sections to ensure that you use the appliance safely.
- Do not use the measuring aid for liquid detergent for gel detergents, washing powder, or if Prewash or "Ready in" time are activated.

Requirement: Find out the optimum dosage for "detergent and care product."

1. Pull out the detergent drawer.
2. Pour in detergent.
→ "Detergent drawer"
3. If required, add the care product.
4. Push in the detergent drawer.



Starting the programme

Note: If you want to change the time until the programme ends, set the "Ready in" time first.

- Press **Start/Reload** .
 - The drum rotates and load detection takes place. This can take up to 2 minutes, after which water enters the drum.
 - The display shows either the programme duration or the "Ready in" time.

Adding laundry

Note: Please read the information in the "Safety" and "Preventing material damage" sections to ensure that you use the appliance safely.

1. Press **Start/Reload** .
The appliance is paused and checks whether it is possible to add or remove laundry.
2. Add or remove laundry.
3. Close the door.
4. Press **Start/Reload** .

Cancelling the programme

Once the programme has started, you can cancel it at any time.

Note: Please read the information in the "Safety" and "Preventing material damage" sections to ensure that you use the appliance safely.

1. Press **Start/Reload** .
2. Open the door.
The appliance door remains locked for safety reasons if the temperature and water levels are high.
If the temperature is high, start the **Rinse/Freshen Up** programme.
If the water level is high: Start the **Spin** or **Drain** programme.
3. Remove the laundry.

Resuming the programme when the programme status is Rinse Hold

1. Set the **Spin** or **Drain** programme.
2. Press **Start/Reload** .

Unloading the laundry

Note: Please read the information in the "Safety" and "Preventing material damage" sections to ensure that you use the appliance safely.

1. Open the door.

2. Remove the laundry.

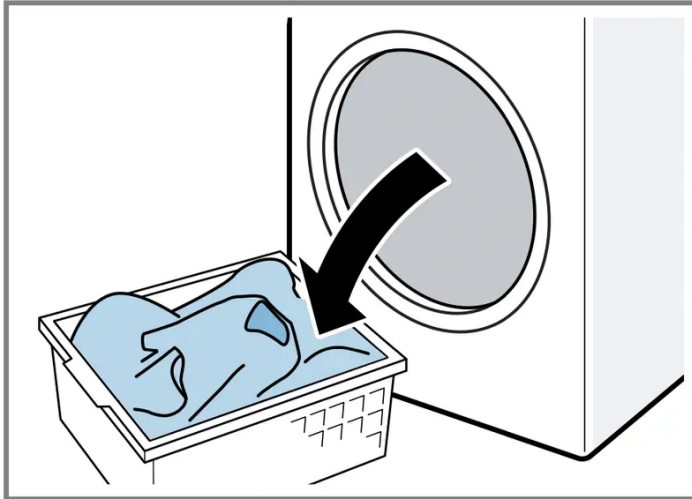

Switching off the appliance

1. Press 

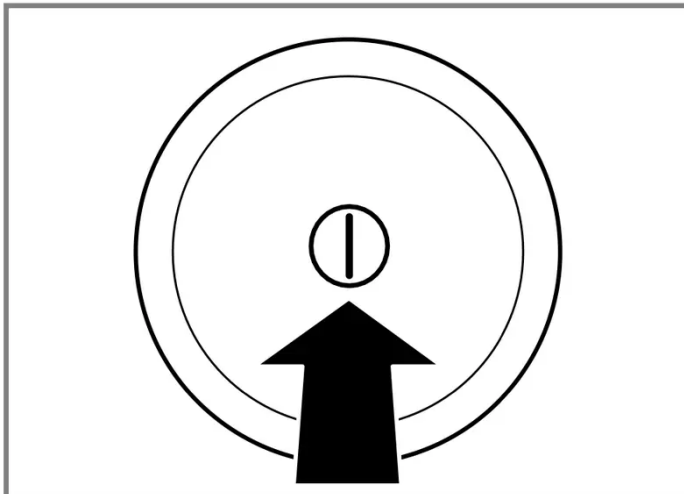

2. Turn off the tap.

3. Wipe the rubber gasket dry and remove any foreign objects.

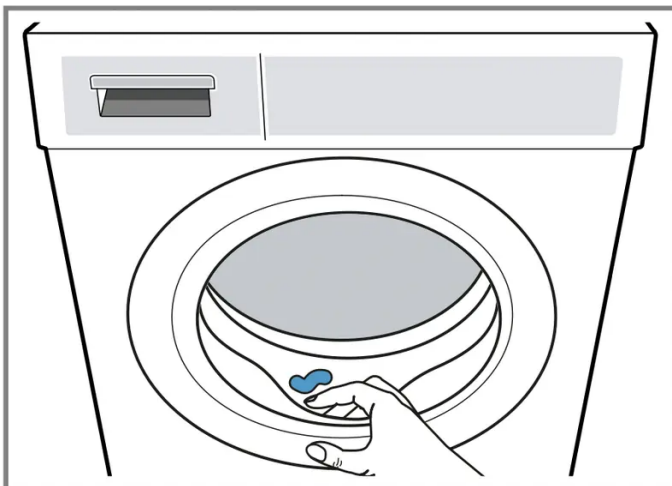

4. Leave the door and detergent drawer open so that residual water can evaporate.

Childproof lock

Secure your appliance against being operated unintentionally using the controls.

Activating the childproof lock

- Press and hold the two **Child Lock push 3 sec.** buttons for approx. 3 seconds.

- The display shows .
- The controls are locked.
- The childproof lock remains active even after the appliance has been switched off.

Deactivating the childproof lock

Requirement: To deactivate the childproof lock, the appliance must be switched on.

- Press and hold the two Child Lock push 3 sec. buttons for approx. 3 seconds.

So that the programme currently running is not cancelled, the programme selector must be set to the initial programme.

 goes out in the display.

Basic settings

You can configure the appliance to meet your needs.



Overview of the basic settings

Below is an overview of the basic settings on the appliance.

Basic setting	Description
end signal	Set the volume of the signal at the end of the programme.
button signal	The volume of the audible signal emitted when the buttons are pressed.
auto power-off	<p>Activate or deactivate the "Automatic switch-off" function for the appliance or set the time after which the appliance automatically switches itself off. → <i>"Save energy and conserve resources", Page 12</i></p> <p>Note: If Wi-Fi is activated, the appliance will not switch itself off automatically.</p>
Drum clean advice	Activate or deactivate the reminder to clean the drum.

Basic setting	Description
Language	Set the language.
Aut. network log-in	"Connect the appliance to a WLAN home network (Wi-Fi) with WPS function" → <i>Page 47</i>
Man. network log-in	"Connect the appliance to a WLAN home network (Wi-Fi) without WPS function." → <i>Page 47</i>
Connect app	"Connect your appliance to the Home Connect app" → <i>Page 48.</i>
Wi-Fi on/off	Activate or deactivate Wi-Fi. → " <i>Activating Wi-Fi on the appliance</i> ", <i>Page 49</i> → " <i>Deactivating Wi-Fi on the appliance</i> ", <i>Page 49</i>
Software update	"Install the software update." → <i>Page 50</i>
Network settings	"Reset the network settings." → <i>Page 50</i>
energy mngmt.	"Connect the appliance to the energy manager." → <i>Page 48</i>

Changing the basic settings

1. To call up the basic settings for the sub-menu, press and hold both buttons  **3 sec.** for approx. 3 seconds.
2. Select the required basic setting.
→ "Overview of the basic settings",
3. Adjust the basic setting.
4. Press  **3 sec.** to call up the main menu.

Cleaning and servicing

To keep your appliance working efficiently for a long time, it is important to clean and maintain it carefully.

Tips on appliance care

Follow the tips for appliance care to ensure your appliance works correctly in the long term.

- Wipe down the housing and the control panel with nothing but water and a damp cloth.
 - The appliance parts remain clean and hygienic.
- Remove all detergent residue, spray residue or other residues immediately.
 - Fresh deposits are easier to remove without leaving any residue.
- Keep the appliance door and detergent drawer open after use.
 - This allows the residual water to dry, reducing odours in the appliance.

Cleaning the drum

If you often wash at a washing temperature of 40 °C and lower or the appliance has not been used for a long period, clean the drum.

CAUTION! Risk of injury! Permanently washing at low temperatures and a lack of ventilation for the appliance may damage the drum and cause injury.

- Regularly run a programme for cleaning the drum or wash at temperatures of at least 60 °C.
- Leave the appliance to dry after every operation with the door open, and leave the detergent drawer to dry.
- Run the Drum clean programme without laundry. Add washing powder.

Cleaning the detergent drawer

Note: Please read the information in the "Safety" and "Preventing material damage" sections to ensure that you use the appliance safely.

1. Pull out the detergent drawer.
2. Press down on the insert and remove the detergent drawer.

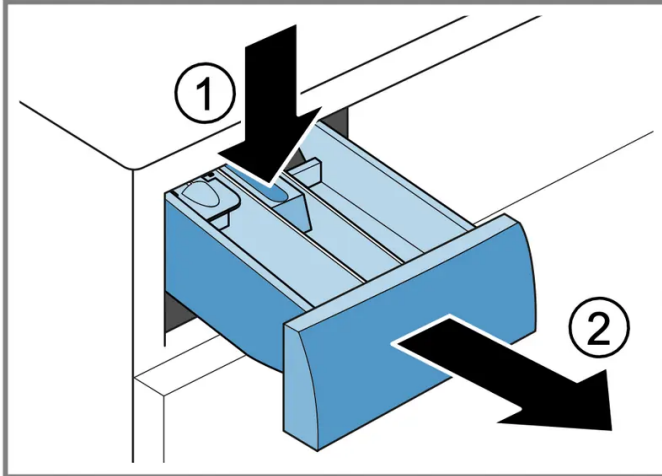

3. Press out the insert upwards from below.

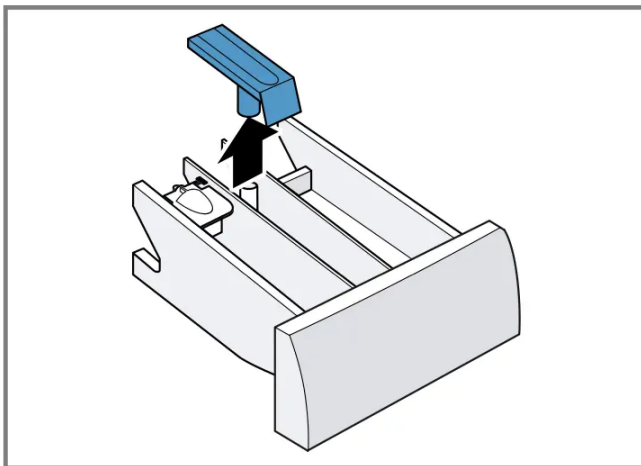

4. Clean the detergent drawer and insert with water and a brush, and then dry them.

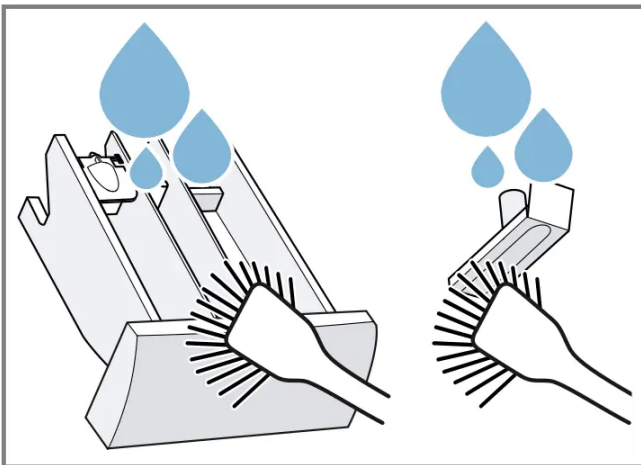

5. Fit the insert and lock it into place.

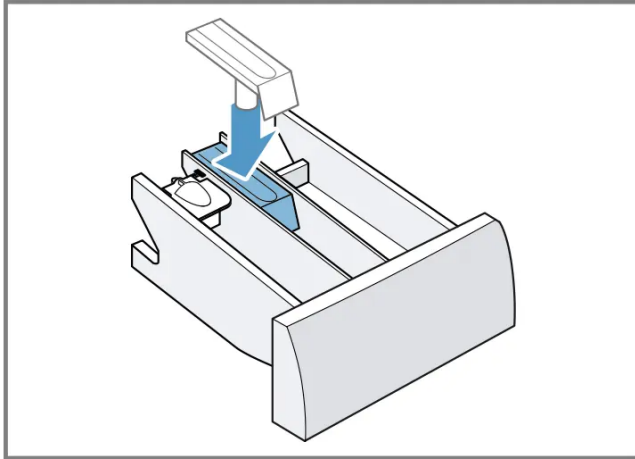

6. Cleaning the opening for the detergent drawer.

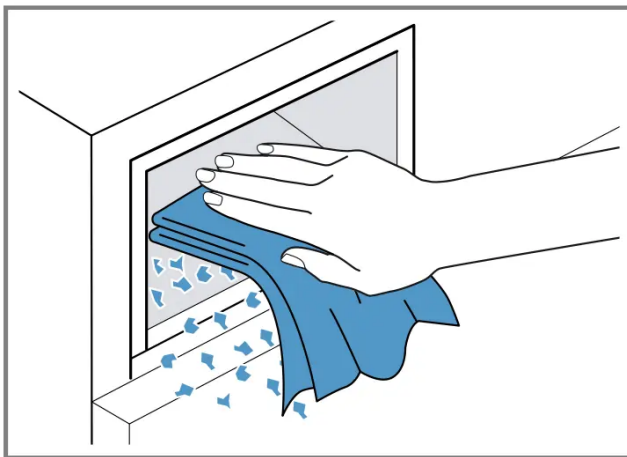

7. Push in the detergent drawer.

Descaling

If you add detergent correctly, you do not need to descale your appliance.

If you still wish to use descaler, follow the manufacturer's instructions for use.

ATTENTION!

The use of unsuitable descaling agents, e.g. for coffee machines, may damage the appliance.

- For this appliance, only use descaling agents that are available from the manufacturer's website or our after-sales service.

Cleaning the drain pump

Clean the drain pump in the event of faults, e.g. blockages or rattling noises.

Emptying the drain pump

Note: Please read the information in the "Safety" and "Preventing material damage" sections to ensure that you use the appliance safely.

1. Turn off the water tap.
2. Switch off the device.
3. Disconnect the appliance's mains plug from the power supply.
4. Open the maintenance flap.

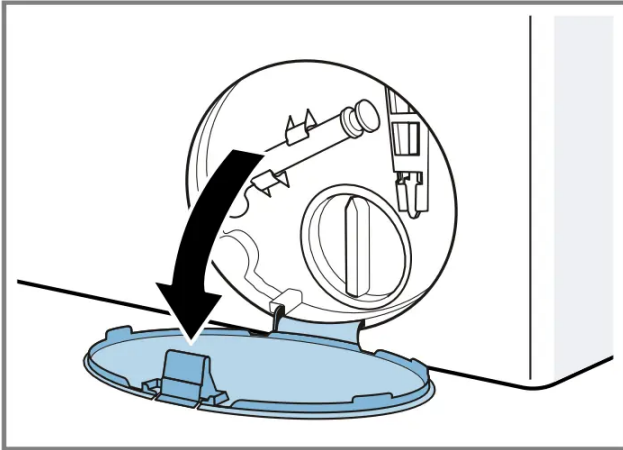

5. Remove the maintenance flap.

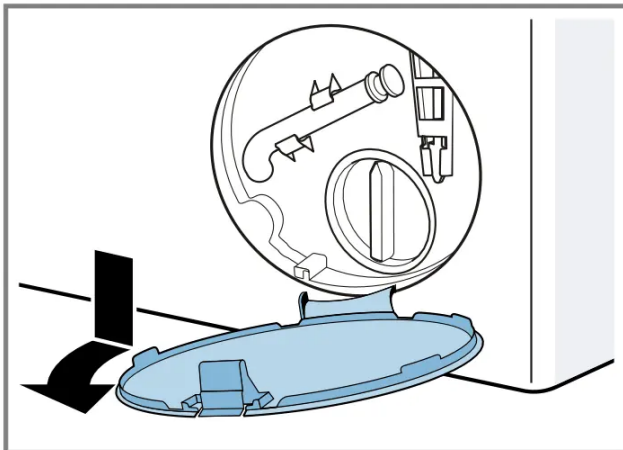

6. Slide a receptacle under the opening.

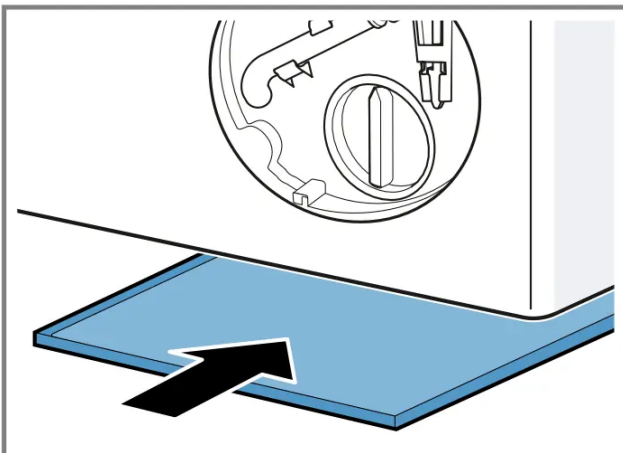

7. Take the drain hose out of the holder.

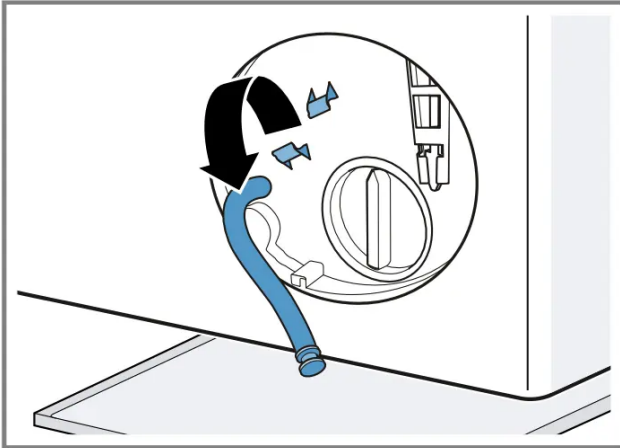

8. **CAUTION - Risk of scalding!**

When you wash at high temperatures, the detergent solution gets hot.

Do not touch the hot detergent solution. To allow the detergent solution to flow out into the container, remove the sealing cap.

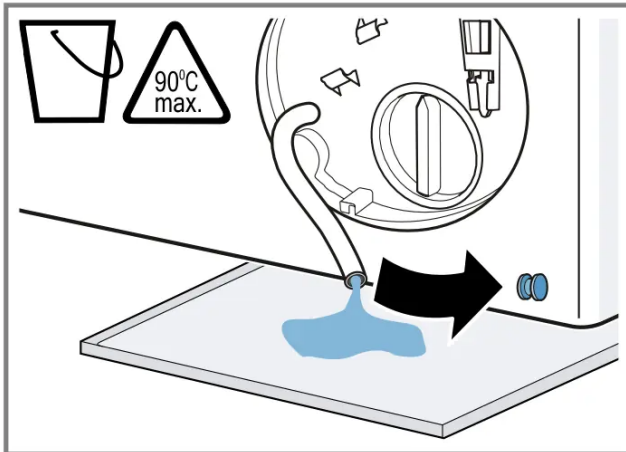

9. Firmly press on the sealing cap.

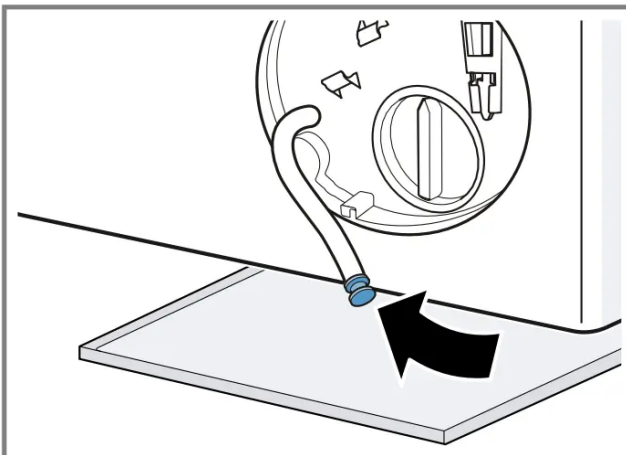

10. Insert the drain hose into the holder.

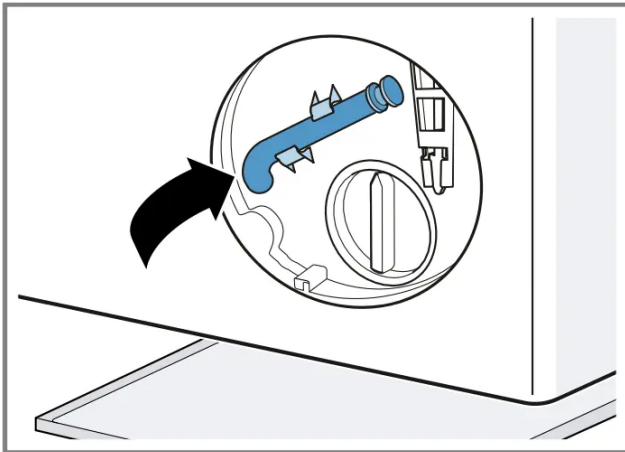

Cleaning the drain pump

Note: Please read the information in the "Safety" and "Preventing material damage" sections to ensure that you use the appliance safely.

Requirement: "The drain pump is empty."

1. Since water may remain in the drain pump, remove the pump cap carefully.
The filter insert in the pump housing may become stuck due to coarse particles of dirt.
Loosen the dirt and remove the filter insert.

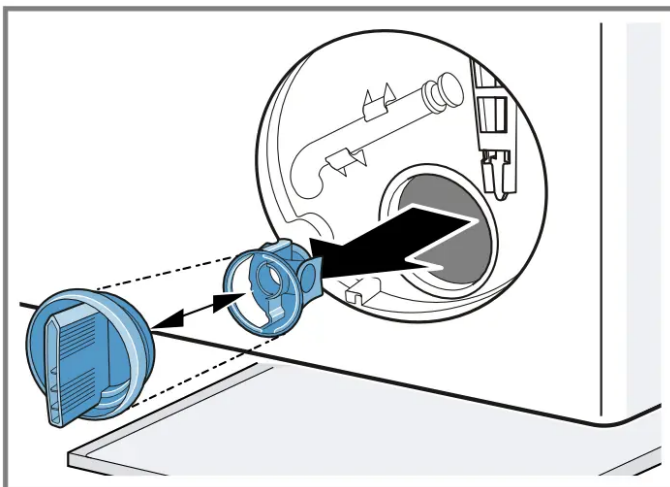

2. Clean the interior, the thread on the pump cap and the pump housing.

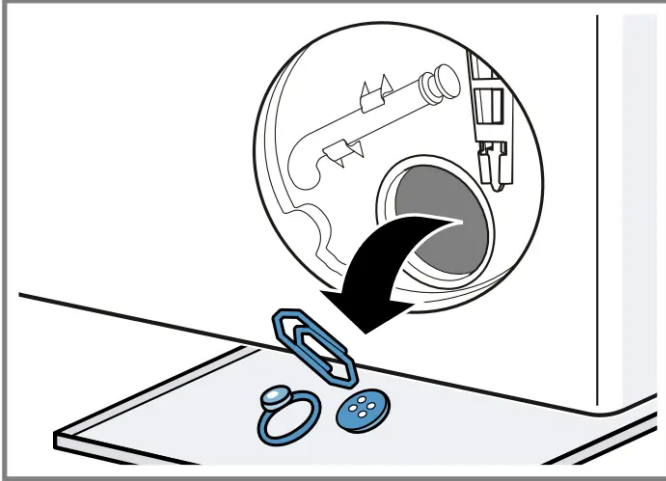

The pump cap is comprised of two parts which can be taken apart for cleaning.

3. Make sure that the impeller in the drain pump can be rotated.
4. Insert the pump cap.

Ensure that the parts of the pump cap are correctly assembled.

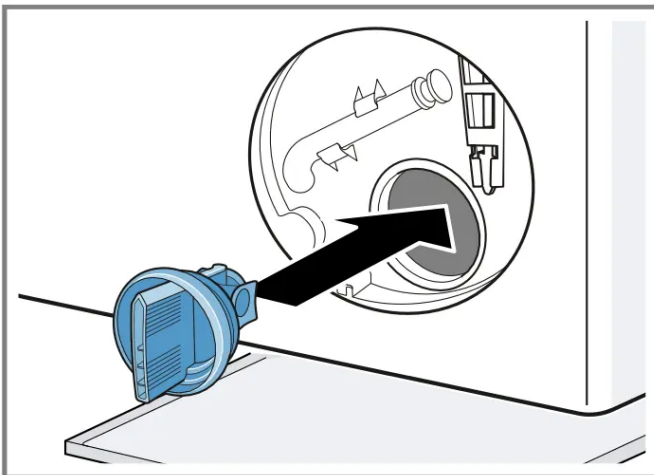

5. Screw on the pump cap.

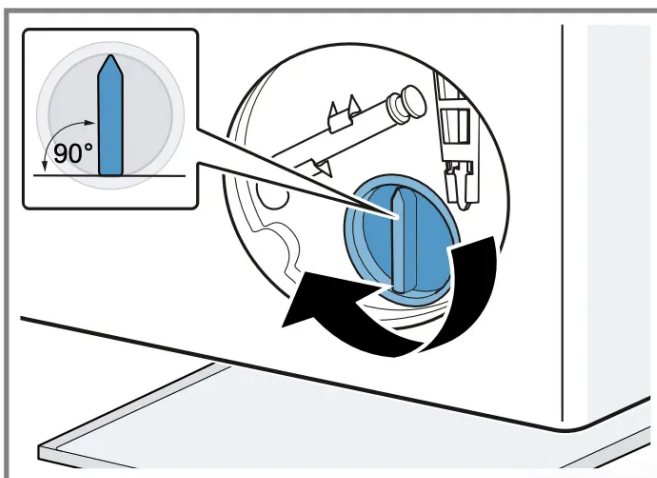

The handle on the pump cap must be in a vertical position.

6. Insert the maintenance flap and lock it into place.

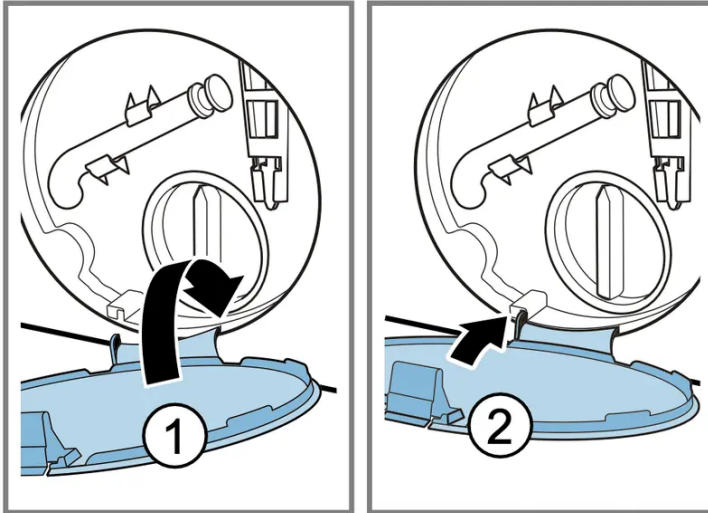

7. Close the maintenance flap.

Before the next wash

To prevent unused detergent from flowing straight into the outlet in the next wash, run the **Drain** programme after you have emptied the drain pump.

1. Turn on the tap.
2. Insert the mains plug.
3. Switch on the appliance.
4. Pour 1 litre of water into compartment II.
5. Start the **Drain** programme.

Cleaning the water outlet hose at the siphon

If the water outlet hose at the siphon is dirty or the detergent solution is not being pumped out, you must clean these.

1. Switch off the appliance.
2. Disconnect the appliance's mains plug from the power supply.

3. Loosen the hose clamp and carefully remove the water outlet hose.

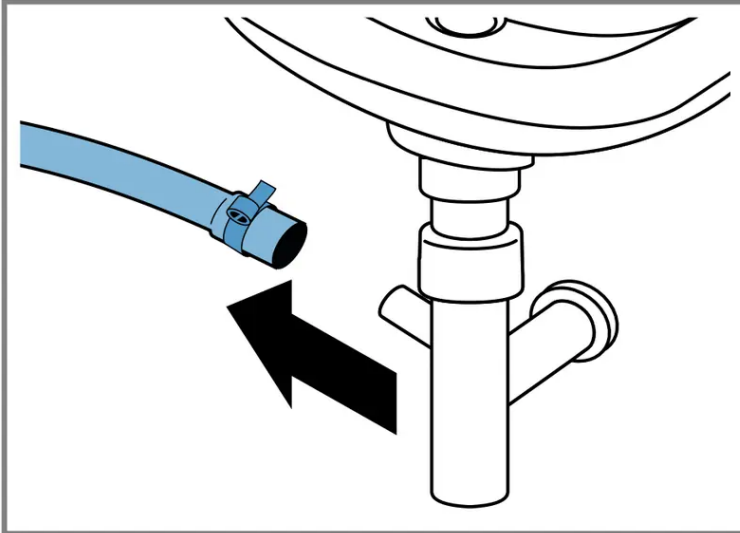

Residual water may leak out.

4. Clean the water outlet hose and siphon connecting piece.

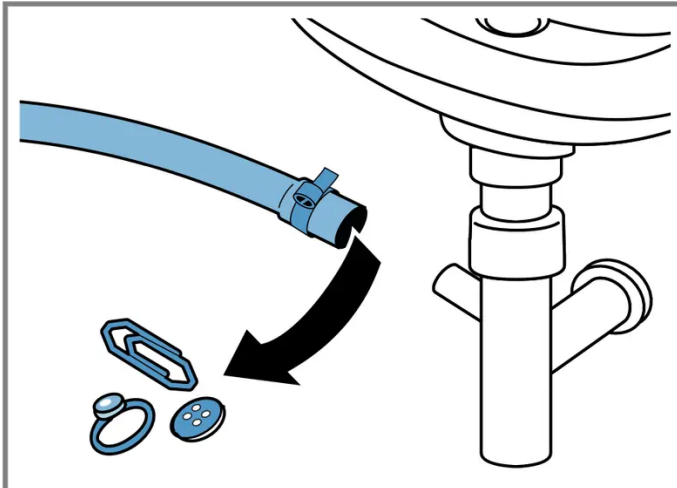

5. Reattach the water outlet hose and secure the connection point using the hose clamp.

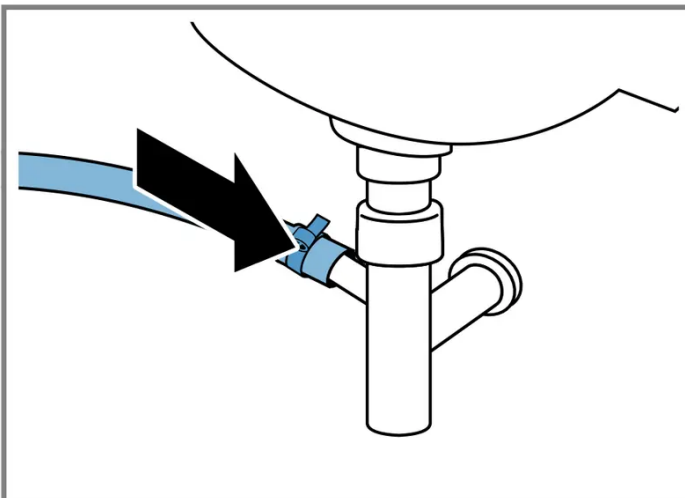

Clean the water inlet filters.

Clean the filter in the water inlet in the event of blockages or if the water pressure is too low.

Emptying the water inlet hose

1. Turn off the tap.
2. Set a programme, except for Rinse/Freshen Up, Spin or Drain.
3. Start the programme and leave it to run for approx. 40 seconds.
4. Switch off the appliance.
5. Disconnect the appliance's mains plug from the power supply.

Cleaning the filter on the tap

Note: Please read the information in the "Safety" and "Preventing material damage" sections to ensure that you use the appliance safely.

Requirement: The water inlet hose is empty.

1. Remove the water inlet hose from the tap.

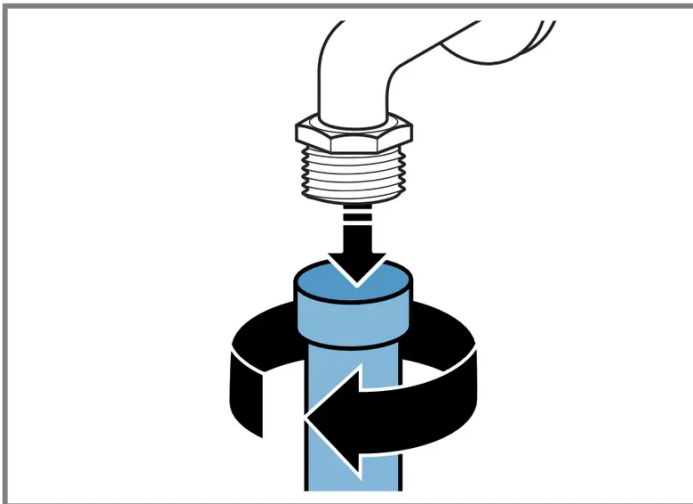

2. Clean the filter with a small brush.

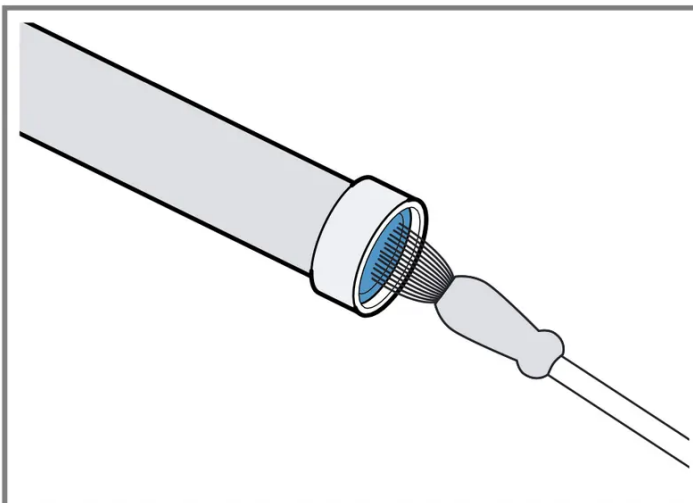

3. Connect the water inlet hose and check for leaks.

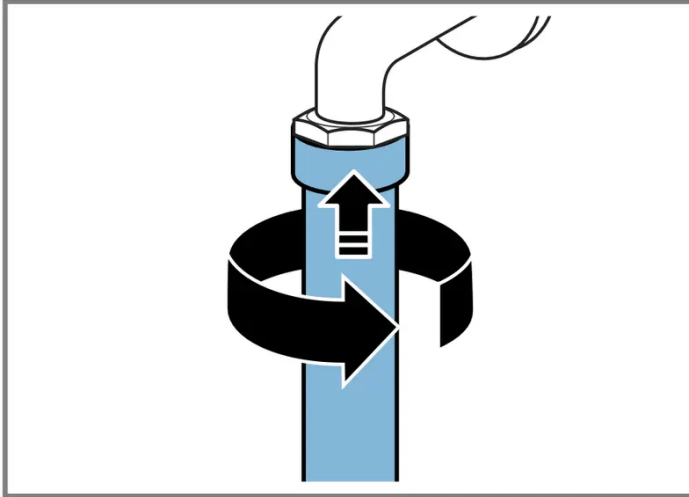

Cleaning the filter on the appliance

Note: Please read the information in the "Safety" and "Preventing material damage" sections to ensure that you use the appliance safely.

Requirement: The water inlet hose is empty.

→ "Emptying the water inlet hose"

1. Disconnect the hose from the rear of the appliance.

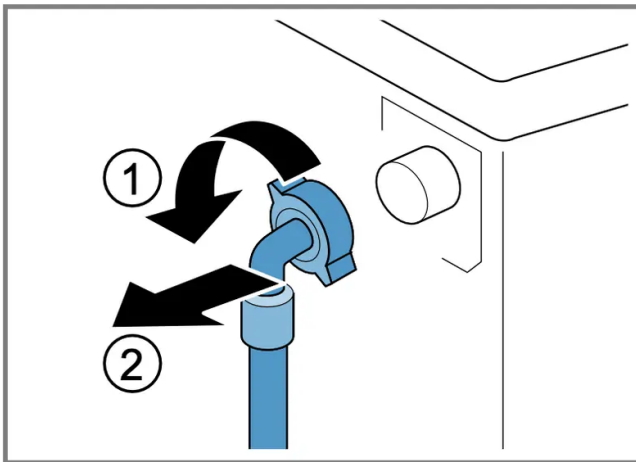

2. Use pliers to remove the filter.

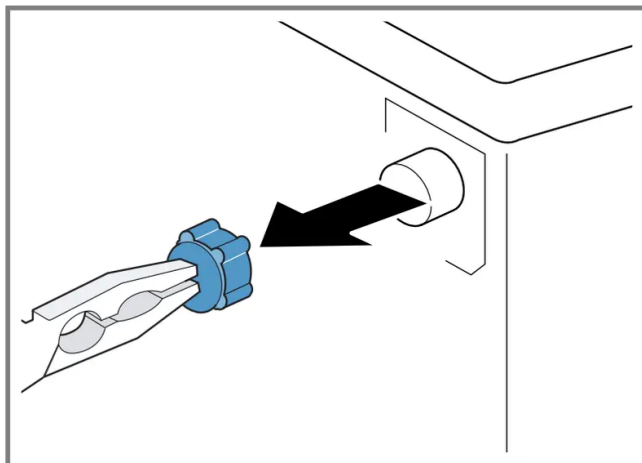

3. Clean the filter with a small brush.

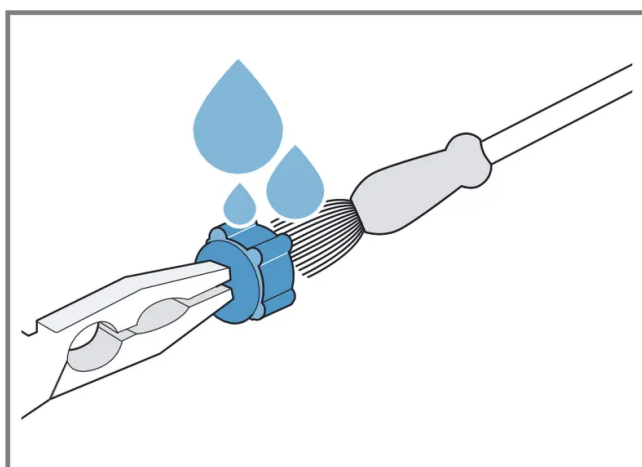

4. Reinsert the filter.

5. Connect the hose and check for leaks.

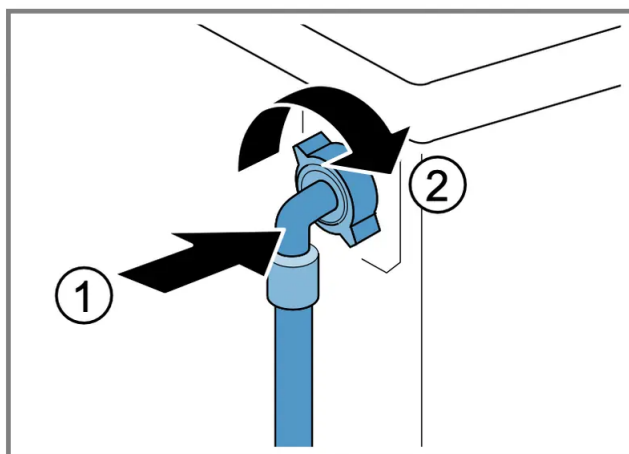

Troubleshooting

You can rectify minor faults on your appliance yourself. Read the troubleshooting information before contacting after-sales service. This will avoid unnecessary costs.

WARNING! Risk of electric shock!

Improper repairs are dangerous.

- Repairs to the appliance should only be carried out by trained specialist staff.
- Only use genuine spare parts when repairing the appliance.
- If the power cord of this appliance is damaged, it must be replaced by the manufacturer, the manufacturer's Customer Service or a similarly qualified person in order to prevent any risk.

Error code / Fault display / Signal







Fault	Cause	Troubleshooting
The display goes out and Start/Reload  flashes.	Energy-saving mode is active	<ul style="list-style-type: none"> • Press any button. The symbol lights up again.
"E:30 / -80"	Drain pipe or water outlet hose is blocked.	<ul style="list-style-type: none"> • Clean the drain pipe and the water outlet hose.
	Drain pipe or water drain hose is caught or jammed.	<ul style="list-style-type: none"> • Ensure that the drain pipe and water drain hose are not kinked or trapped.
	Drain pump is blocked.	<ul style="list-style-type: none"> • → "Cleaning the drain pump", Page 53.
	The water outlet hose is connected too high.	<ul style="list-style-type: none"> • Install the water outlet hose at a maximum height of 1 metre. → "Technical specifications", Page 70.
	Pump cover is not correctly assembled.	<ul style="list-style-type: none"> • Correctly assemble the pump cover.
"E:36 / -25 / -26"	Drain pump is blocked.	<ul style="list-style-type: none"> • → "Cleaning the drain pump", Page 53.
"E:60 / -2B"	The unbalanced load detection system has interrupted the spin cycle because the laundry is unevenly distributed.	<ul style="list-style-type: none"> • Redistribute the laundry in the drum. <p>Note: Where possible, mix large and small items in the drum. Different sized items of laundry distribute themselves better during the spin cycle.</p>
"E:10 / -10"	The filters in the water inflow are blocked.	<ul style="list-style-type: none"> • "Clean the filters in the water inflow" → Page 57.



Fault	Cause	Troubleshooting
	The tap is turned off.	<ul style="list-style-type: none"> • Turn on the tap.
	The water inlet hose is kinked or jammed.	<ul style="list-style-type: none"> • Ensure that the water inlet hose is not kinked or jammed.
All other error codes.	Malfunction	<ul style="list-style-type: none"> • Call the after-sales service. → "Customer Service", Page 68.
Water cooling	To protect the wastewater pipes, the hot detergent solution is cooled before being drained.	Wait until the detergent solution has cooled down.





Malfunctions



Fault	Cause	Troubleshooting
The appliance is not working.	The mains plug of the power cord is not plugged in.	<ul style="list-style-type: none"> • Connect the appliance to the power supply.
	The circuit breaker is faulty.	<ul style="list-style-type: none"> • Check the circuit breaker in the fuse box.
	There has been a power cut.	<ul style="list-style-type: none"> • Check whether the lighting in your kitchen or other appliances are working.
The programme does not start.	You have not pressed Start/Reload 	Press Start/Reload 
	Door is not closed.	<ol style="list-style-type: none"> 1. Close the door. 2. Press Start/Reload  to start the programme.
	Childproof lock is activated.	<ul style="list-style-type: none"> • → "Deactivating the childproof lock", Page 46.
	Finish in is activated.	<ul style="list-style-type: none"> • Check whether Finish in is activated. → "Buttons", Page 26.
	Laundry is caught in the door.	<ol style="list-style-type: none"> 1. Open the door again. 2. Remove any trapped laundry. 3. Close the door. 4. Press Start/Reload  to start the programme.
The door cannot be opened.	Rinse Hold  is activated.	<ul style="list-style-type: none"> • Continue the programme by selecting Spin or Drain and

Fault	Cause	Troubleshooting
		pressing Start/Reload  → "Resuming the programme when the programme status is Rinse Hold", Page 45.
	The temperature is too high.	<ul style="list-style-type: none"> • Wait until the temperature has dropped. • → "Cancelling the programme", Page 45.
	Water level is too high.	<ul style="list-style-type: none"> • Start the Drain programme.
	Power failure.	<ul style="list-style-type: none"> • Open the door using the emergency release. → "Emergency release", Page 66
The water is not draining.	Drain pipe or water outlet hose is blocked.	<ul style="list-style-type: none"> • Clean the drain pipe and the water outlet hose.
	Drain pipe or water drain hose is caught or jammed.	<ul style="list-style-type: none"> • Ensure that the drain pipe and water drain hose are not kinked or trapped.
	Drain pump is blocked.	<ul style="list-style-type: none"> • → "Cleaning the drain pump", Page 53.
	Rinse Hold  is activated.	<ul style="list-style-type: none"> • Continue the programme by selecting Spin or Drain and pressing Start/Reload  → "Resuming the programme when the programme status is Rinse Hold", Page 45
		<ul style="list-style-type: none"> • Install the water outlet hose at a maximum height of 1 metre.

Fault	Cause	Troubleshooting
	The water outlet hose is connected too high.	→ "Technical specifications", Page 70
	Pump cover is not correctly assembled.	<ul style="list-style-type: none"> • Correctly assemble the pump cover.
Water is not flowing in. Detergent is not being dispensed.	You have not pressed Start/Reload 	<ul style="list-style-type: none"> • Press Start/Reload 
	The filters in the water inflow are blocked.	<ul style="list-style-type: none"> • "Clean the filters in the water inflow" → Page 57.
	The tap is turned off.	<ul style="list-style-type: none"> • Turn on the tap.
	The water inlet hose is kinked or jammed.	<ul style="list-style-type: none"> • Ensure that the water inlet hose is not kinked or jammed.
The spin cycle runs several times.	The unbalanced load detection system eliminates an imbalance by repeatedly redistributing the laundry.	<ul style="list-style-type: none"> • Not a fault – no action required. <p>Note: When loading, where possible, place large and small items of laundry together in the drum. Different sized items of laundry distribute themselves better during the spin cycle.</p>
The programme duration changes during the wash cycle.	The programme operation is optimised electronically. This may change the programme duration.	<ul style="list-style-type: none"> • Not a fault – no action required.
	The unbalanced load detection system eliminates an imbalance by	<ul style="list-style-type: none"> • Not a fault – no action required.

Fault	Cause	Troubleshooting
	repeatedly redistributing the laundry.	Note: When loading, where possible, place large and small items of laundry together in the drum. Different sized items of laundry distribute themselves better during the spin cycle.
	Foam detection system switches on a rinse cycle if foam build-up is too high.	<ul style="list-style-type: none"> • Not a fault – no action required.
No water is visible in the drum.	Water is below the visible area.	<ul style="list-style-type: none"> • Not a fault – no action required.
Drum jerks after the programme starts.	This is caused by an internal motor test.	<ul style="list-style-type: none"> • Not a fault – no action required.
Residual water is present in the compartment 	Insert in compartment  is blocked.	<ul style="list-style-type: none"> • → "Cleaning the detergent drawer", Page 52
Vibrations and movement of the appliance whilst spinning.	Appliance is not correctly aligned.	<ul style="list-style-type: none"> • Aligning the appliance
	The appliance feet are not fixed.	<ul style="list-style-type: none"> • Secure the appliance feet. Aligning the appliance
	Transit bolts have not been removed.	<ul style="list-style-type: none"> • Removing the transit bolts
Drum does not turn, water does not flow in.	Load detection is active.	<ul style="list-style-type: none"> • Not a fault – no action required. <p>Note: The load detection can take up to two minutes.</p>
		<ul style="list-style-type: none"> • Immediate measure: Mix one tablespoon of fabric softener

Fault	Cause	Troubleshooting
Heavy foam build-up	Detergent dosage is too high.	<p>with 0.5 litres of water and pour the mixture into the left-hand compartment (not for outdoor clothing, sportswear or items stuffed with down).</p> <ul style="list-style-type: none"> • Reduce the amount of detergent for the next washing cycle with the same load.

Noise

Fault	Cause	Troubleshooting
Rushing, hissing noise.	Water is flushed under pressure into the detergent drawer.	<ul style="list-style-type: none"> • Not a fault – normal operating noise.
Loud noises during the spin cycle.	Appliance is not correctly aligned.	<ul style="list-style-type: none"> • Aligning the appliance
	The appliance feet are not fixed.	<ul style="list-style-type: none"> • Secure the appliance feet. Aligning the appliance
	Transit bolts have not been removed.	<ul style="list-style-type: none"> • Removing the transit bolts
Banging noises, rattling in the drain pump.	Foreign bodies have got into the drain pump.	<ul style="list-style-type: none"> • → "Cleaning the drain pump", Page 53.
Slurping, rhythmical suction noise.	The drain pump is active, the detergent solution is pumped out.	<ul style="list-style-type: none"> • Not a fault – normal operating noise.

Problem with results

Fault	Cause	Troubleshooting
Creasing.	The spin speed is too high.	<ul style="list-style-type: none"> • The next time you run a wash cycle, set a lower spin speed.
	The load is too large.	<ul style="list-style-type: none"> • The next time you run a wash cycle, reduce the amount of laundry being loaded.
	The wrong programme is selected for the type of fabric.	<p>Select the programmes that are suitable for the type of fabric. → "Programmes", Page 29</p>
Detergent or fabric softener drips off the seal and collects on the door or in the seal fold.	Too much detergent/fabric softener in the detergent drawer.	<ul style="list-style-type: none"> • When dosing liquid detergent and fabric softener, observe the marking in the detergent drawer and do not dose above this.
The spin result is not satisfactory. The laundry is too wet/too damp.	A low spin speed is selected.	<ul style="list-style-type: none"> • The next time you run a wash cycle, set a higher spin speed. • Start the Spin programme.
	Less Ironing is activated.	<ul style="list-style-type: none"> • Select the programmes that are suitable for the type of fabric. → "Programmes", Page 29.
	The unbalanced load detection system has interrupted the spin cycle because the laundry is unevenly distributed.	<ul style="list-style-type: none"> • Redistribute the laundry in the drum. <p>Note: Where possible, mix large and small items in the drum. Different sized items of laundry distribute</p>

Fault	Cause	Troubleshooting
		<p>themselves better during the spin cycle.</p> <ul style="list-style-type: none"> • Start the Spin programme.
Detergent residue on the damp washing.	Detergents may contain water-insoluble substances that deposit on the laundry.	<ul style="list-style-type: none"> • Start the Rinse/Freshen Up programme.
Detergent residue on the dry laundry.	Detergents may contain water-insoluble substances that deposit on the laundry.	<ul style="list-style-type: none"> • Brush out the laundry after washing and drying.

Home Connect problem

Fault	Cause	Troubleshooting
HomeConnect is not working correctly.	Different causes are possible.	
No connection to the home network.	Wi-Fi is switched off.	<ul style="list-style-type: none"> • → "Activating Wi-Fi on the appliance", Page 49
	Wi-Fi is activated but a connection to your home network cannot be established.	<ol style="list-style-type: none"> 1. Ensure that the home network is available. 2. Reconnect the appliance to the home network. → "Connecting the appliance to a WLAN home network (Wi-Fi) with WPS function" → "Connecting the appliance to a WLAN home network (Wi-Fi) without WPS function"

Leakage

Fault	Cause	Troubleshooting
Water is leaking out at the water inlet hose.	Water inlet hose is not correctly/securely connected.	<ol style="list-style-type: none"> 1. Connect the water supply hose correctly. Connecting the water inlet hose 2. Tighten the screw connection.
Water is leaking out at the water outlet hose.	The water outlet hose is damaged.	<ul style="list-style-type: none"> • Replace the damaged water outlet hose.
	Water outlet hose is not connected correctly.	<ul style="list-style-type: none"> • Connect the water outlet hose correctly. Water outlet connection types

Odours

Fault	Cause	Troubleshooting
Odours have formed in the appliance.	Humidity and detergent residue may promote the formation of bacteria.	<ul style="list-style-type: none"> • → "Cleaning the drum", Page 52 • If you are not using the appliance, leave the door and detergent drawer open so that residual water can evaporate.

Emergency release

To remove the laundry in the event of a power failure, for example, you can manually release the door.

Releasing the door

Requirement: "The drain pump is empty."

1. **ATTENTION!** Escaping water may cause material damage.
Do not open the door if you can see water through the glass.
Pull the emergency release downwards with a tool and release.

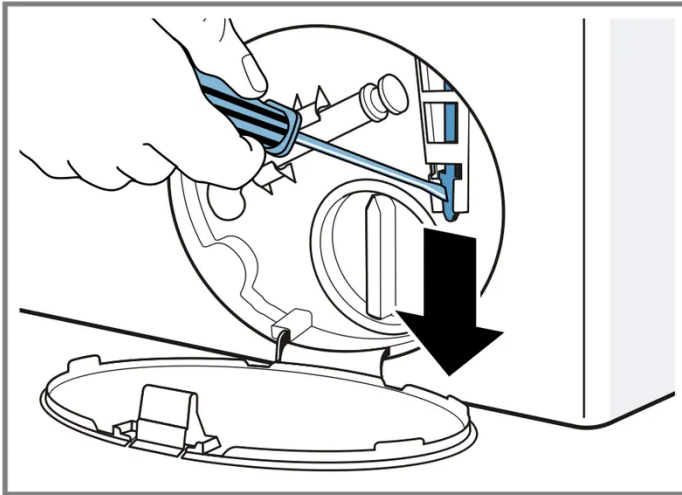

The door lock is released.

2. Insert the maintenance flap and lock it into place.
3. Close the maintenance flap.

Warning

This content is compiled from multiple sources and is provided for reference purposes only. It may not be complete or fully applicable to all situations. If you are unable to resolve your issue, please contact the product manufacturer or an authorized service provider for official support.