

Operating Instructions

Using the surface units.

Throughout this manual, features and appearance may vary from your model.

How to Set

Push the knob in and turn in either direction to the setting you want.

At both **OFF** and **HI** the control **clicks** into position. You may hear slight **clicking** sounds during cooking, indicating the control is keeping the power level you set.

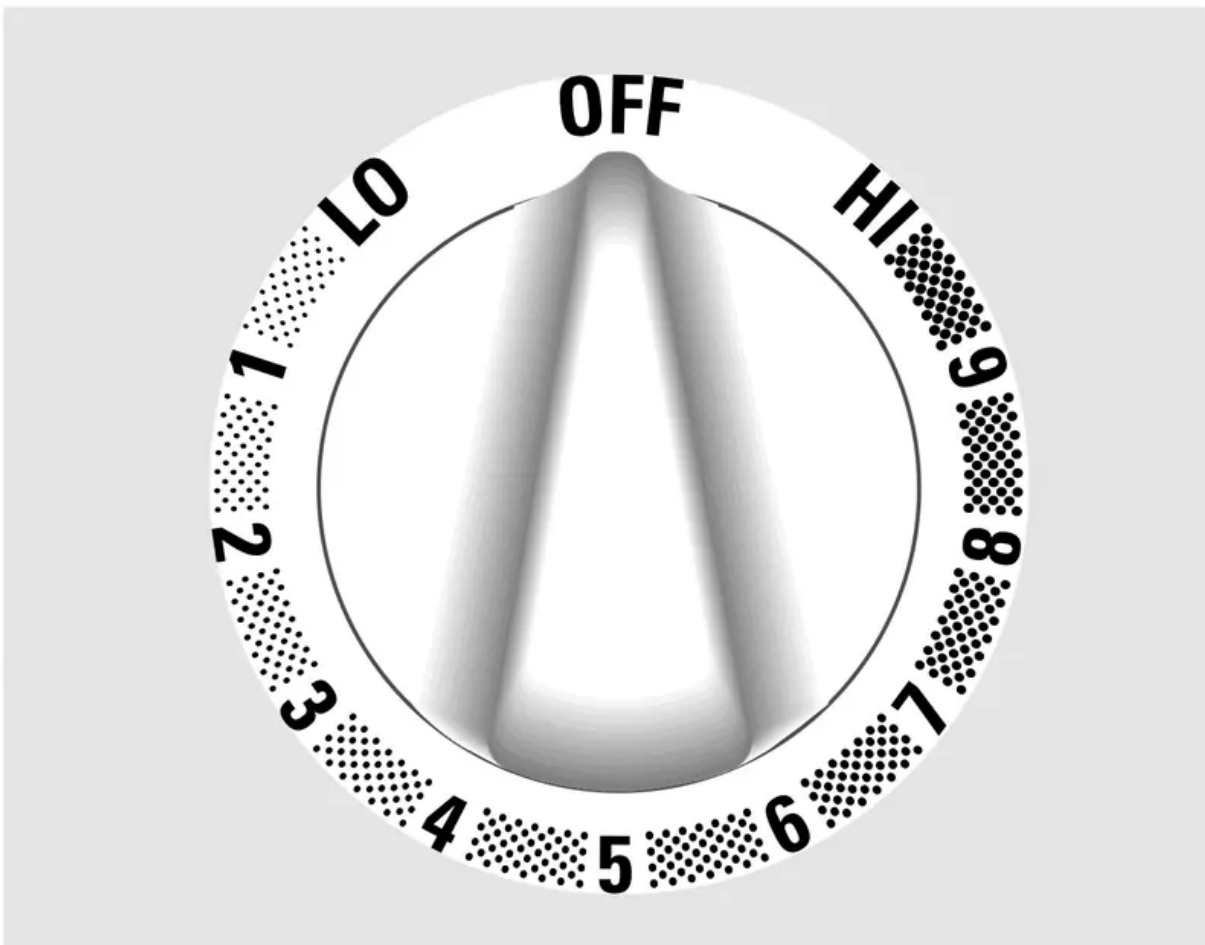

Be sure you turn the control knob to OFF when you finish cooking.

A **HOT COOKTOP** indicator light will glow when any radiant element is turned on, and will remain on until the surface is cooled to approximately 150°F.

Indicator light will;

- come on when the unit is hot to the touch.
- stay on even after the unit is turned off.

- glow until the unit is cooled to approximately 150°F.

Dual Surface Unit Control Knob

The right front surface unit has 2 cooking sizes to select from so you can match the size of the unit to the size of the cookware you are using.

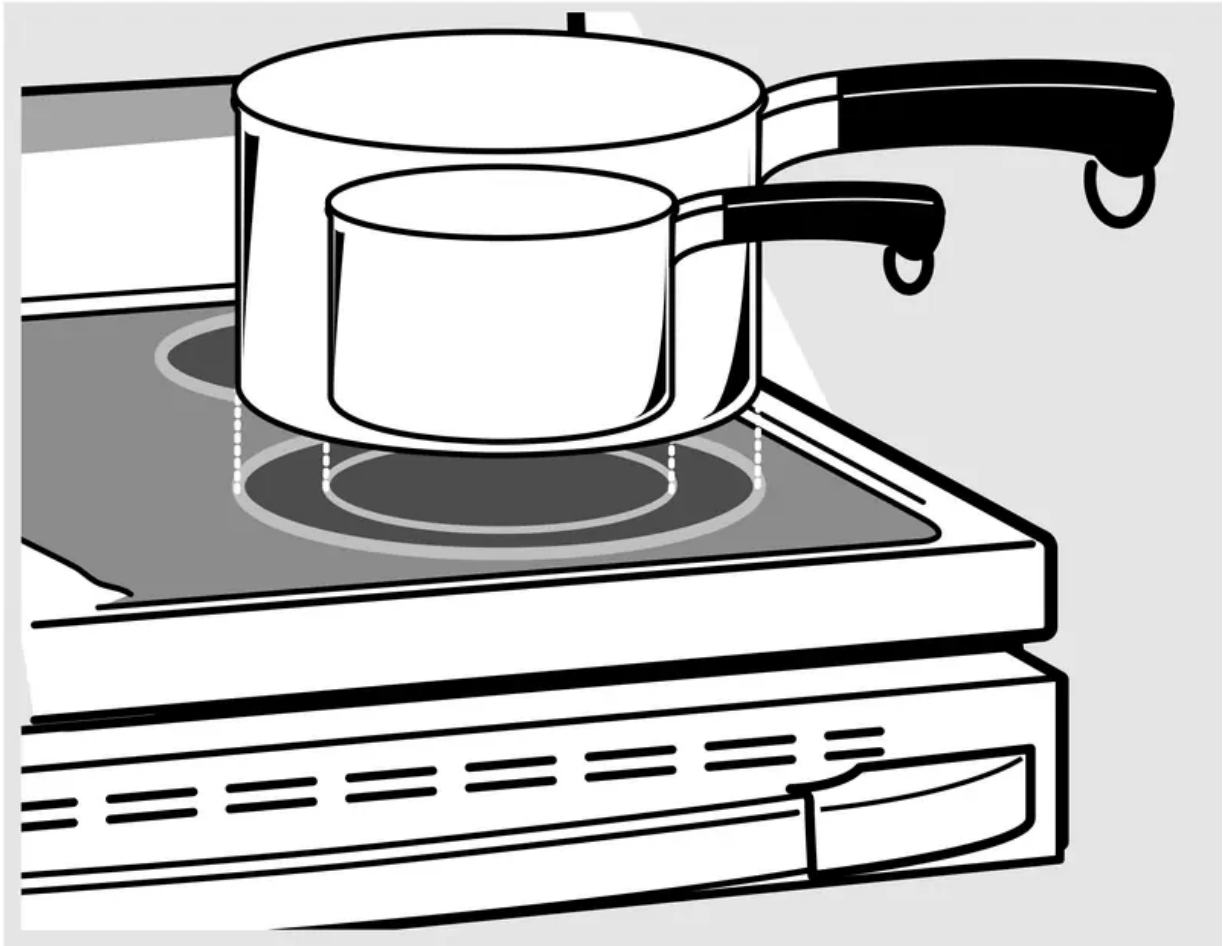

To use the small (6 inch) surface unit, turn the control knob to the **SMALL BURNER** settings.

To use the large (9 inch) surface unit, turn the control knob to the **LARGE BURNER** settings.

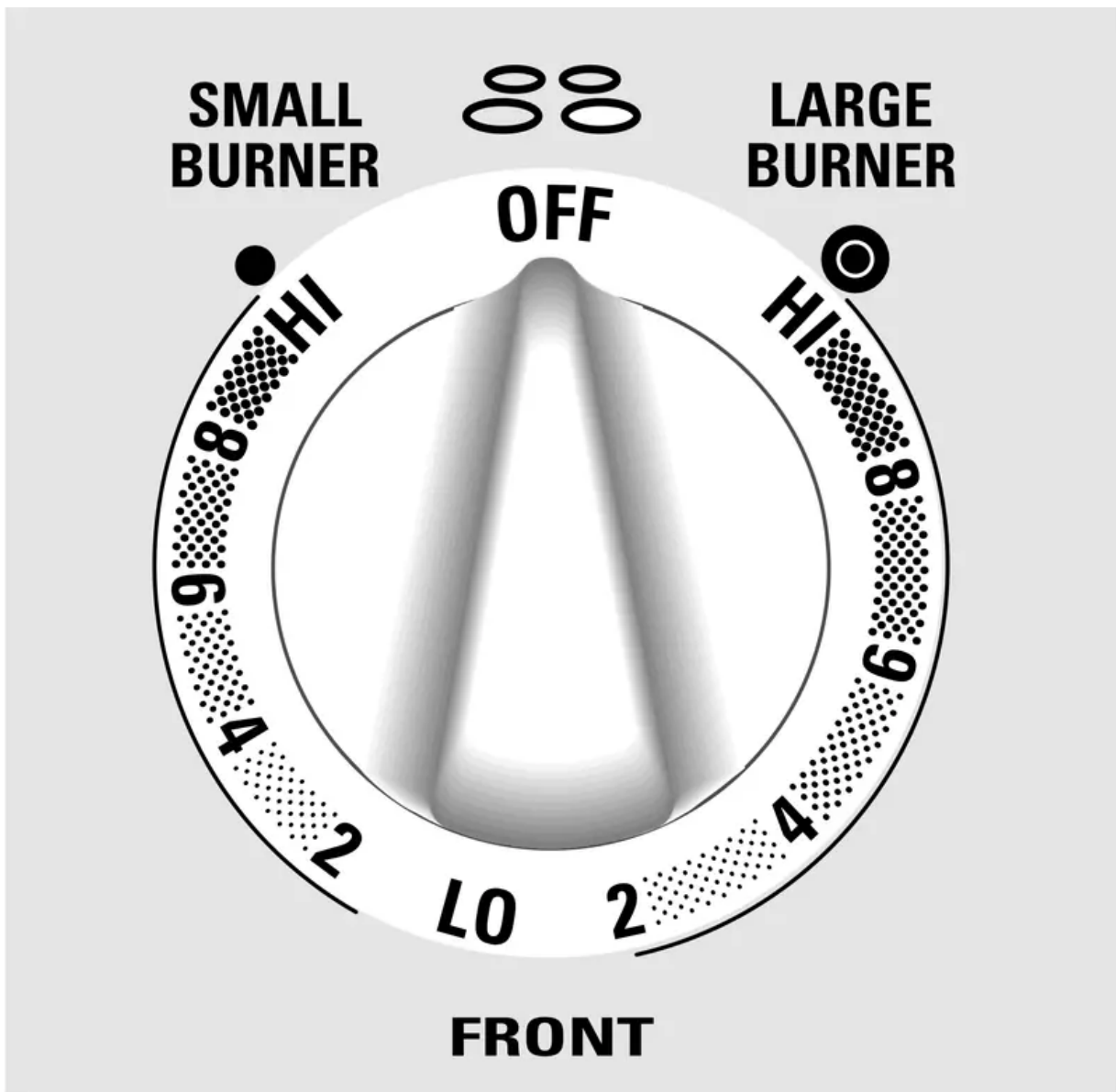

Temperature Limiter

Every radiant surface unit has a temperature limiter.

The temperature limiter protects the glass cooktop from getting too hot.

The temperature limiter may cycle the units off for a time if:

- The pan boils dry.
- The pan bottom is not flat.
- The pan is off center.
- There is no pan on the unit.

Home Canning Tips

Be sure the canner is centered over the surface unit.

Make sure the canner is flat on the bottom.

To prevent burns from steam or heat, use caution when canning.

Use recipes and procedures from reputable sources. These are available from manufacturers such as Ball® and Kerr® and the Department of Agriculture Extension Service.

Wok Cooking

We recommend that you use only a flat-bottomed wok. They are available at your local retail store.

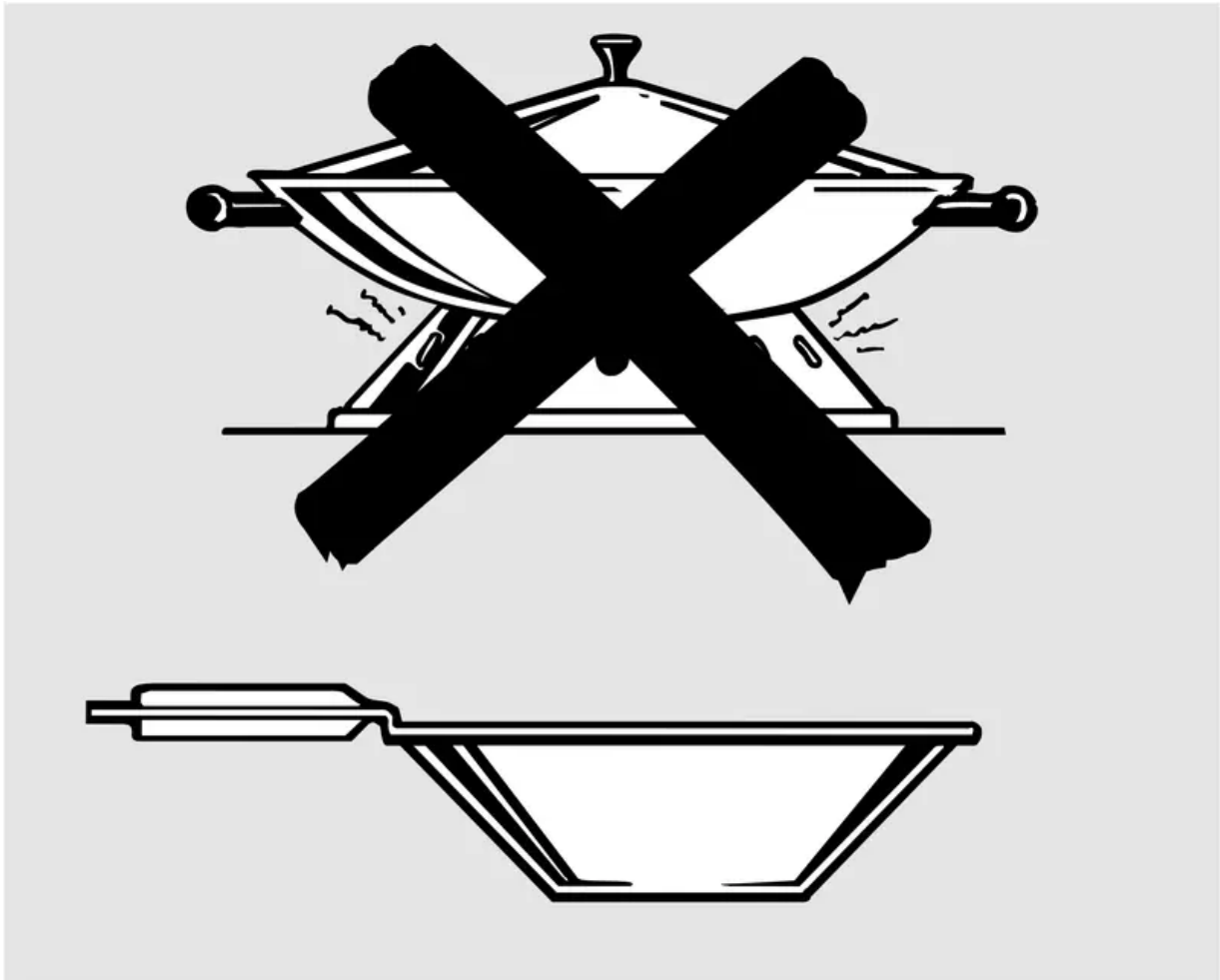

Use only flat-bottomed woks.

Do not use woks that have support rings.

Placing the ring over the surface unit will cause a build-up of heat that will damage the cooktop.

Do not use round bottom woks. You could be seriously burned if the wok tipped over.

The following information will help you choose cookware which will give good performance on glass cooktops.

About the radiant surface units...



Never cook directly on the glass. Always use cookware.



Always place , the pan in the center of the surface unit you are cooking on.

The radiant cooktop features heating units beneath a smooth glass surface.

NOTE: A slight odor is normal when a new cooktop is used for the first time. It is caused by the heating of new parts and insulating materials and will disappear in a short time.

The surface unit will cycle on and off to maintain your selected control setting.

It is safe to place hot cookware on the glass surface even when the cooktop is cool.

Even after the surface units are turned off, the glass cooktop retains enough heat to continue cooking. To avoid overcooking, remove pans from the surface units when the food is cooked. Avoid placing anything on the surface unit until it has cooled completely.



Do not slide cookware across the cooktop because it can scratch the glass—the glass is scratch resistant, not scratch proof.

- Water stains (mineral deposits) are removable using the cleaning cream or full strength white vinegar.
- Use of window cleaner may leave an iridescent film on the cooktop. The cleaning cream will remove this discoloration.
- Don't store heavy items above the cooktop. If they drop onto the cooktop, they can cause damage.
- Do not use the surface as a cutting board.

Selecting types of cookware.

Throughout this manual, features and appearance may vary from your model.

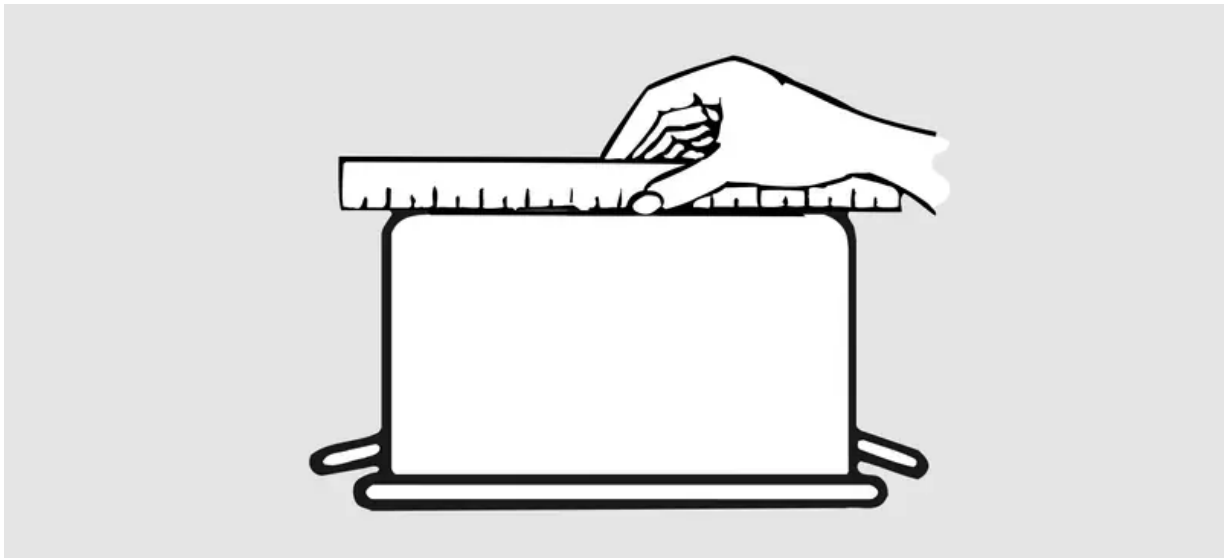

Check pans for flat bottoms by using a straight edge.

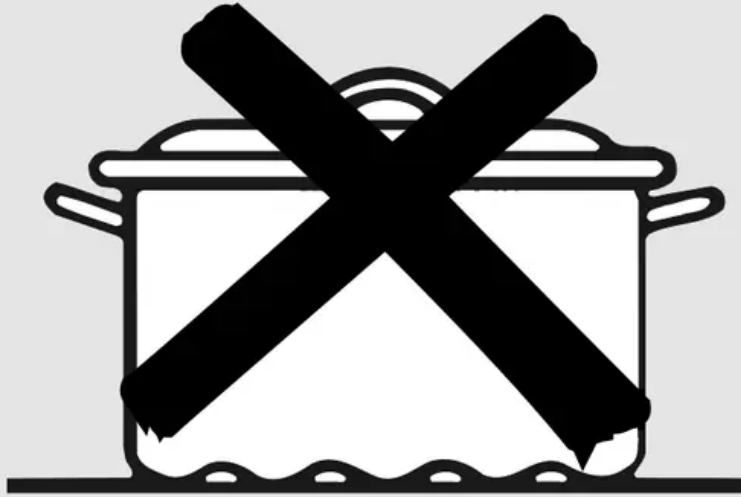

Pans with rounded, curved, ridged or warped bottoms are not recommended.

Stainless Steel:

recommended

Aluminum:

heavy weight recommended

Good conductivity. Aluminum residues sometimes appear as scratches on the cooktop, but can be removed if cleaned immediately. Because of its low melting point, thin weight aluminum should not be used.

Copper Bottom:

recommended

Copper may leave residues which can appear as scratches. The residues can be removed, as long as the cooktop is cleaned immediately. However, do not let these pots boil dry. Overheated metal can bond to glass cooktops. An overheated copper bottom pot will leave a residue that will permanently stain the cooktop if not removed immediately.

Porcelain Enamel Covered Cast Iron:

recommended

As long as the cookware is covered completely with porcelain enamel, this cookware is recommended. Caution is recommended for cast iron cookware that is not completely covered with smooth porcelain enamel, as it may scratch the glass ceramic cooktop.

Glass-ceramic:

usable, but not recommended

Poor performance. May scratch the surface.

Stoneware:

usable, but not recommended

Poor performance. May scratch the surface.

Using the oven controls.

Throughout this manual, features and appearance may vary from your model.

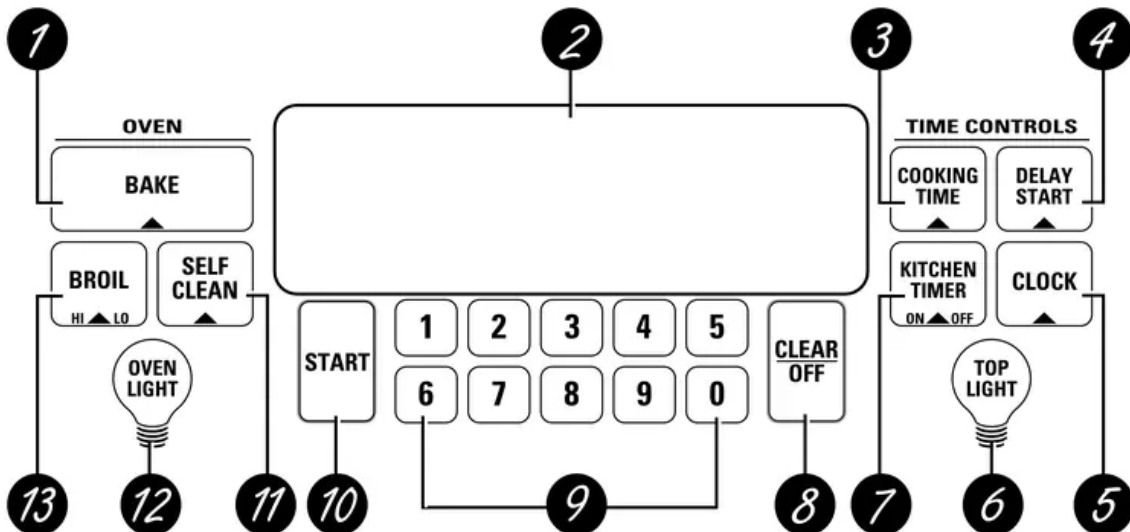

Oven Control, Clock and Timer Features and Settings

1. BAKE Pad

Press this pad to select the bake function.

2. Display

Shows the time of day, oven temperature, whether the oven is in the bake, broil or self-cleaning mode and the times set for the timer or automatic oven operations.

If “F– and a number or letter” flash in the display and the oven control signals, this indicates a function error code. If your oven was set for a timed oven operation and a power outage occurred, the clock and all programmed functions must be reset.

The time of day will flash in the display when there has been a power outage.

3. COOKING TIME Pad

Press this pad and then press the number pads to set the amount of time you want your food to cook. The oven will shut off when the cooking time has run out.

4. DELAY START Pad

Use along with **COOKING TIME** or **SELF CLEAN** pads to set the oven to start and stop automatically at a time you set.

5. CLOCK Pad

Press this pad before setting the clock.

6. TOP LIGHT Pad

Press this pad to turn the surface light on or off.

7. KITCHEN TIMER ON/OFF Pad

Press this pad to select the timer feature.

8. CLEAR/OFF Pad

Press this pad to cancel ALL oven operations except the clock and timer.

9. Number Pads

Use to set any function requiring numbers such as the time of day on the clock, the timer, the oven temperature, the internal food temperature, the start time and length of operation for timed baking and self-cleaning.

10. START Pad

Must be pressed to start any cooking or cleaning function.

11. SELF CLEAN Pad

Press this pad to select the self-cleaning function. See the Using the self-cleaning oven section.

Do not lock the oven door with the latch during cooking. The latch is used for self-cleaning only.

12. OVEN LIGHT Pad

Press this pad to turn the oven light on or off.

13. BROIL HI/LO Pad

Press this pad to select the broil function.

Special features of your oven control.

Your new touch pad control has additional features that you may choose to use. The following are the features and how you may activate them.

The special feature modes can only be activated while the display is showing the time of day. They remain in the control's memory until the steps are repeated.

When the display shows your choice, press the START pad. The special features will remain in memory after a power failure.

12 Hour Shut-Off

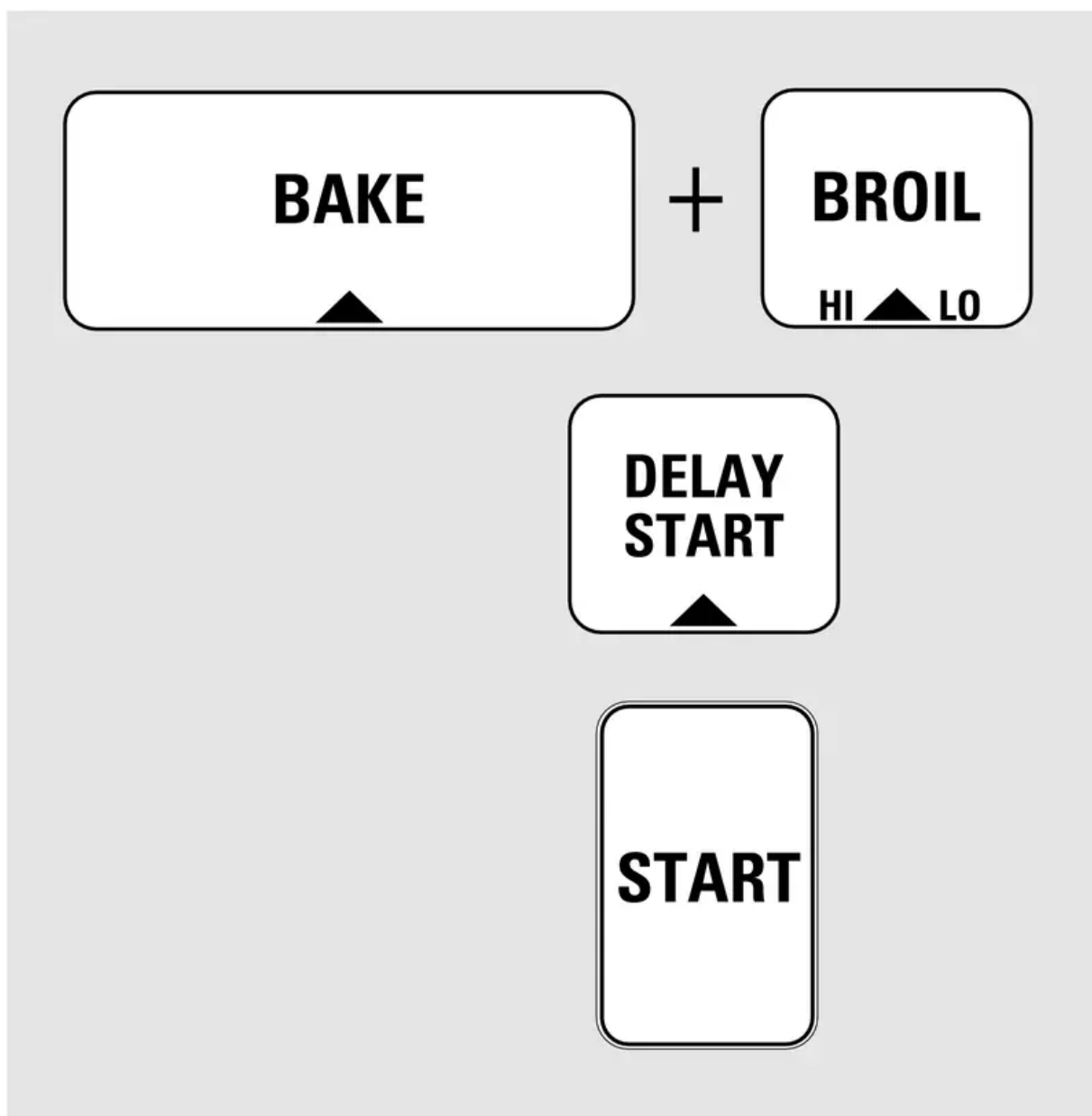

With this feature, should you forget and leave the oven on, the control will automatically turn off the oven after 12 hours during baking functions or after 3 hours during a broil function.

If you wish to turn **OFF** this feature, follow the steps below.

1. Press the **BAKE** and **BROIL HI/LO** pads at the same time for 3 seconds until the display shows **SF**.
2. Press the **DELAY START** pad. The display will show **12 shdn** (12 hour shut-off). Press the **DELAY START** pad again and the display will show **no shdn** (no shut-off).
3. Press the **START** pad to activate the no shut-off and leave the control set in this special features mode.

Fahrenheit or Celsius Temperature Selection

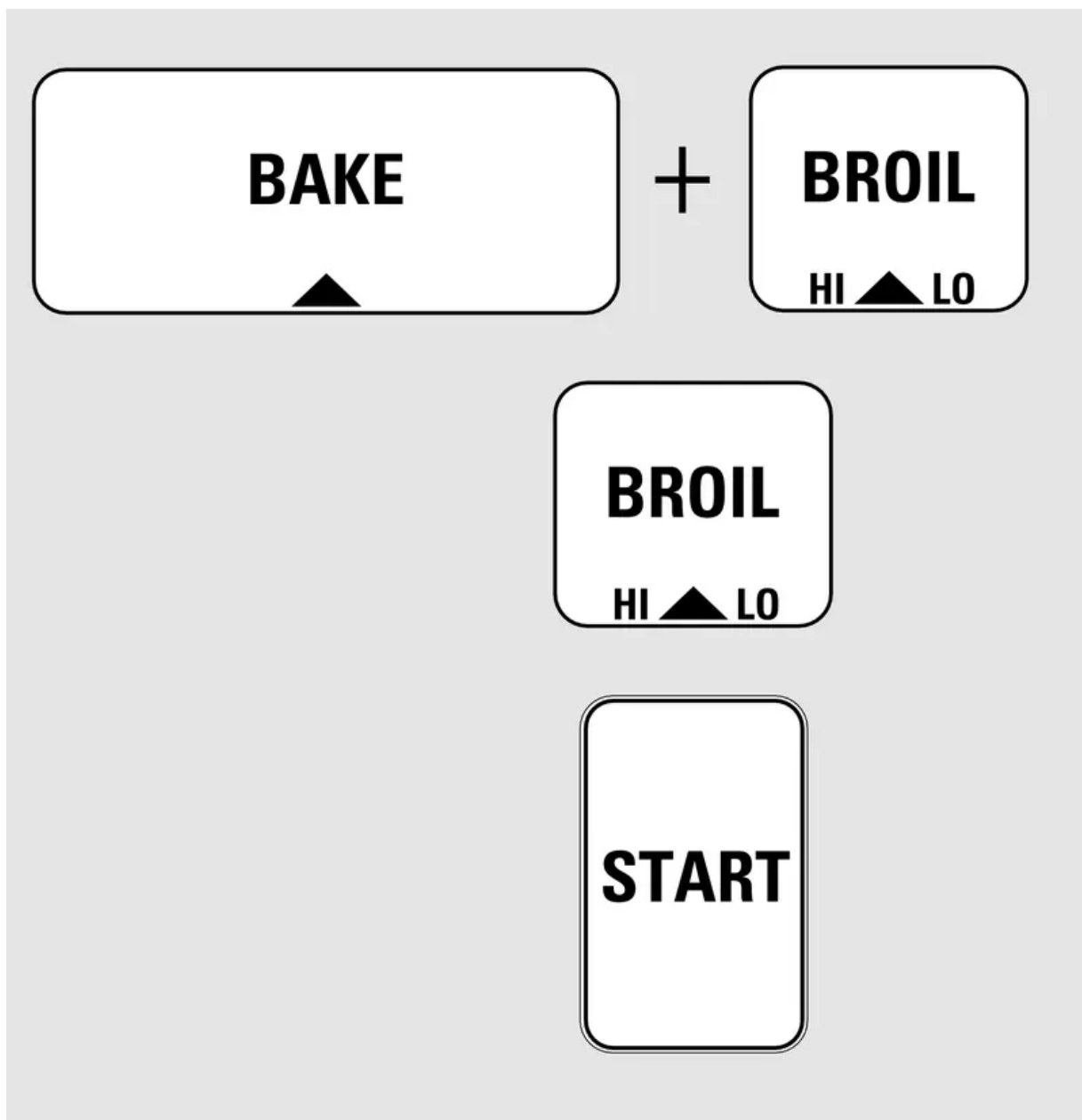

Your oven control is set to use the Fahrenheit temperature selections but you may change this to use the Celsius selections.

1. Press the **BAKE** and **BROIL HI/LO** pads at the same time for 3 seconds until the display shows **SF**.
2. Press the **BROIL HI/LO** pad. The display will show **F** (Fahrenheit).
3. Press the **BROIL HI/LO** pad again. The display will show **C** (Celsius).
4. Press the **START** pad.

Control Lockout

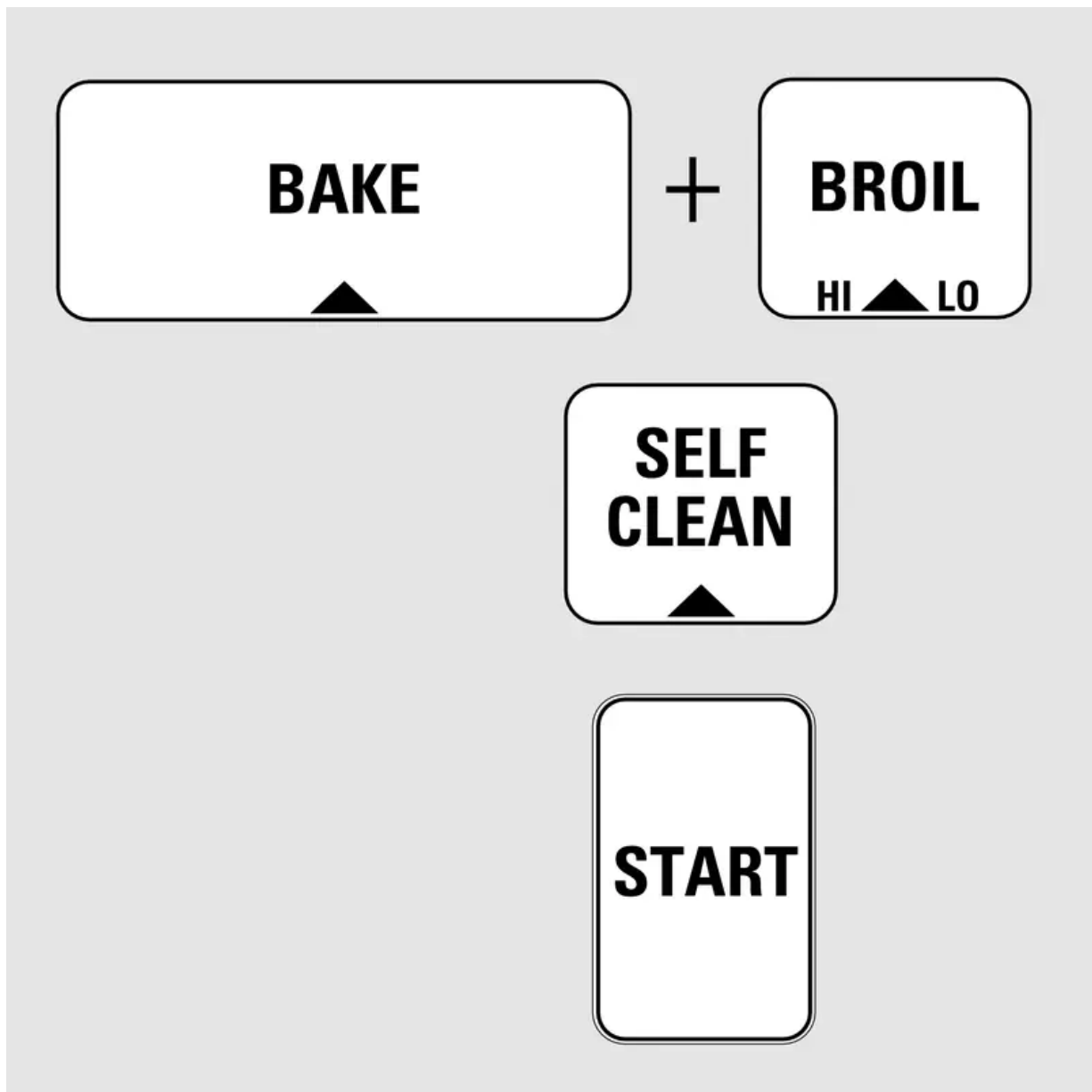

Your control will allow you to lock out the touch pads so they cannot be activated when pressed.

1. Press the **BAKE** and **BROIL HI/LO** pads at the same time for 3 seconds until the display shows SF.
2. Press the **SELF CLEAN** pad. The display will show **LOC OFF**. Press the **SELF CLEAN** pad again. The display will show **LOC ON**.
3. Press the **START** pad to activate the control lockout feature and leave the control set in this special features mode.

When this feature is on and the touch pads are pressed the control will beep and the display will show **LOC**.

NOTE: The control lockout mode will not affect the CLOCK and KITCHEN TIMER ON/OFF touch pads.

Tones at the End of a Timed Cycle

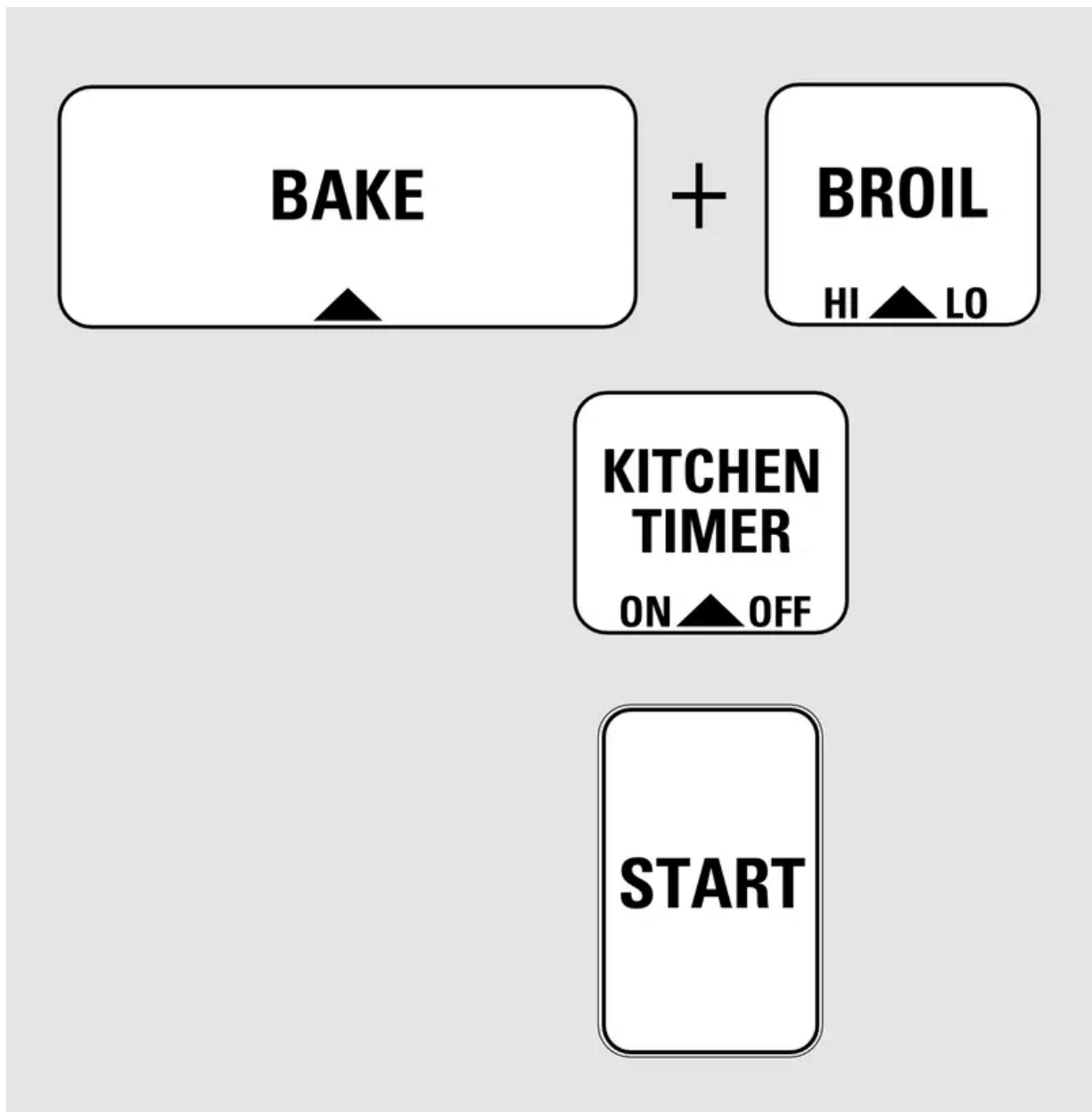

At the end of a timed cycle, 3 short beeps will sound followed by one beep every 6 seconds until the CLEAR/OFF pad is pressed. This continual 6 second beep may be canceled.

To cancel the 6 second beep:

1. Press the **BAKE** and **BROIL HI/LO** pads at the same time for 3 seconds until the display shows **SF**.
2. Press the **KITCHEN TIMER ON/OFF** pad. The display shows **CON BEEP** (continual beep). Press the **KITCHEN TIMER ON/OFF** pad again. The display shows **BEEP**. (This cancels the one beep every 6 seconds.)
3. Press the **START** pad.

12 Hour, 24 Hour or Clock Black-Out

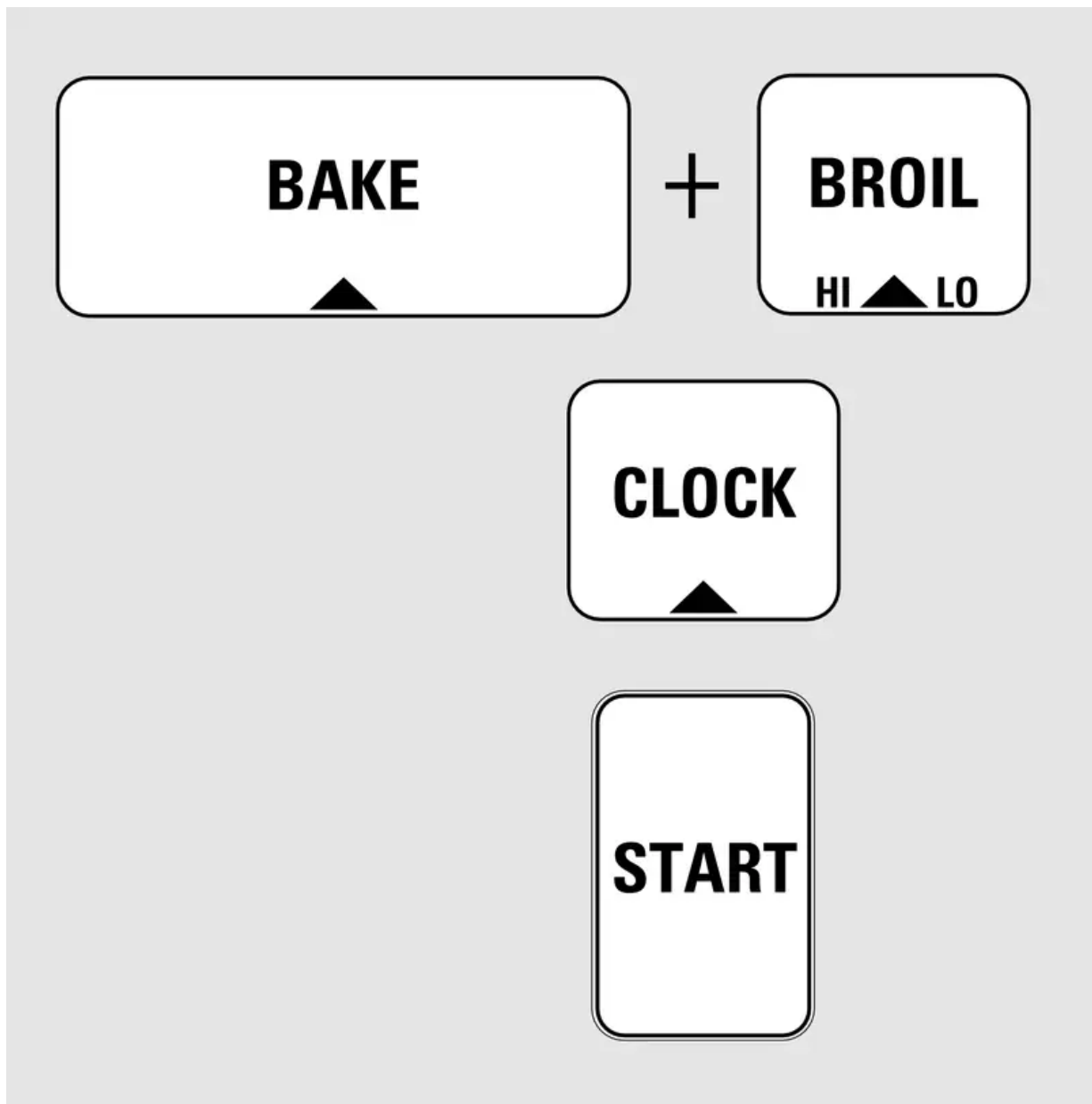

Your control is set to use a 12 hour clock.

If you would prefer to have a 24 hour military time clock or black-out the clock display, follow the steps below.

1. Press the **BAKE** and **BROIL HI/LO** pads at the same time for 3 seconds until the display shows **SF**.
2. Press the **CLOCK** pad once. The display will show **12 hr**. If this is the choice you want, press the **START** pad.

Press the **CLOCK** pad again to change to the 24 hour military time clock. The display will show 24 hr. If this is the choice you want, press the **START** pad.

Press the **CLOCK** pad again to black-out the clock display. The display will show **OFF**. If this is the choice you want, press the **START** pad.

NOTE: If the clock is in the black-out mode you will not be able to use the Delay Start function.

Cook and Hold

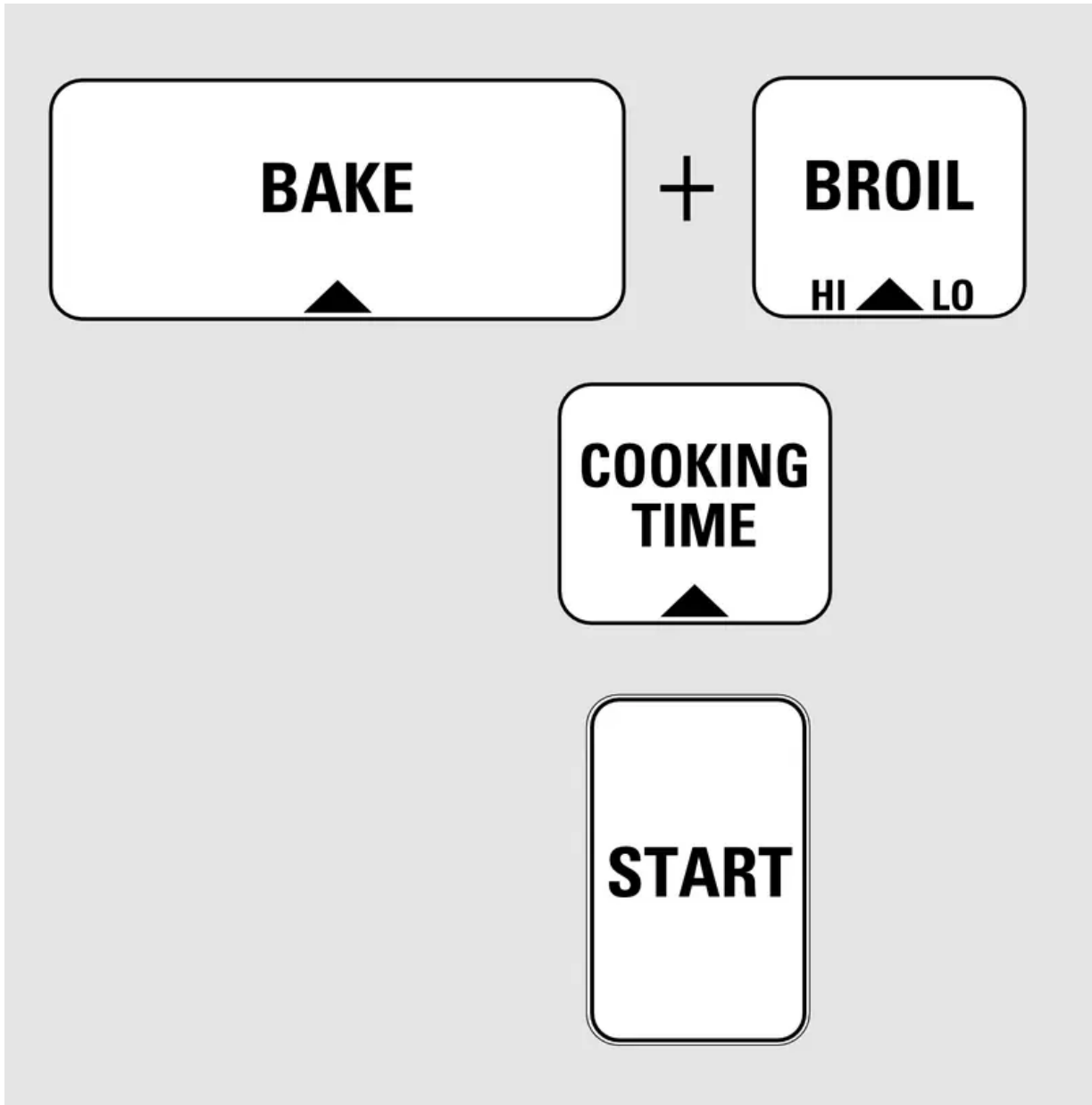

Your new control has a cook and hold feature that keeps cooked foods warm for up to 3 hours after the cooking function is finished.

To activate this feature, follow the steps below.

1. Press the **BAKE** and **BROIL HI/LO** pads at the same time for 3 seconds until the display shows **SF**.
2. Press the **COOKING TIME** pad. The display will show **Hid OFF**. Press the **COOKING TIME** pad again to activate the feature. The display will show **Hid ON**.
3. Press the **START** pad to activate the cook and hold feature and leave the control set in this special features mode.

Using the oven

To avoid possible burns, place the shelves in the desired position before you turn the oven on.

Before you begin...

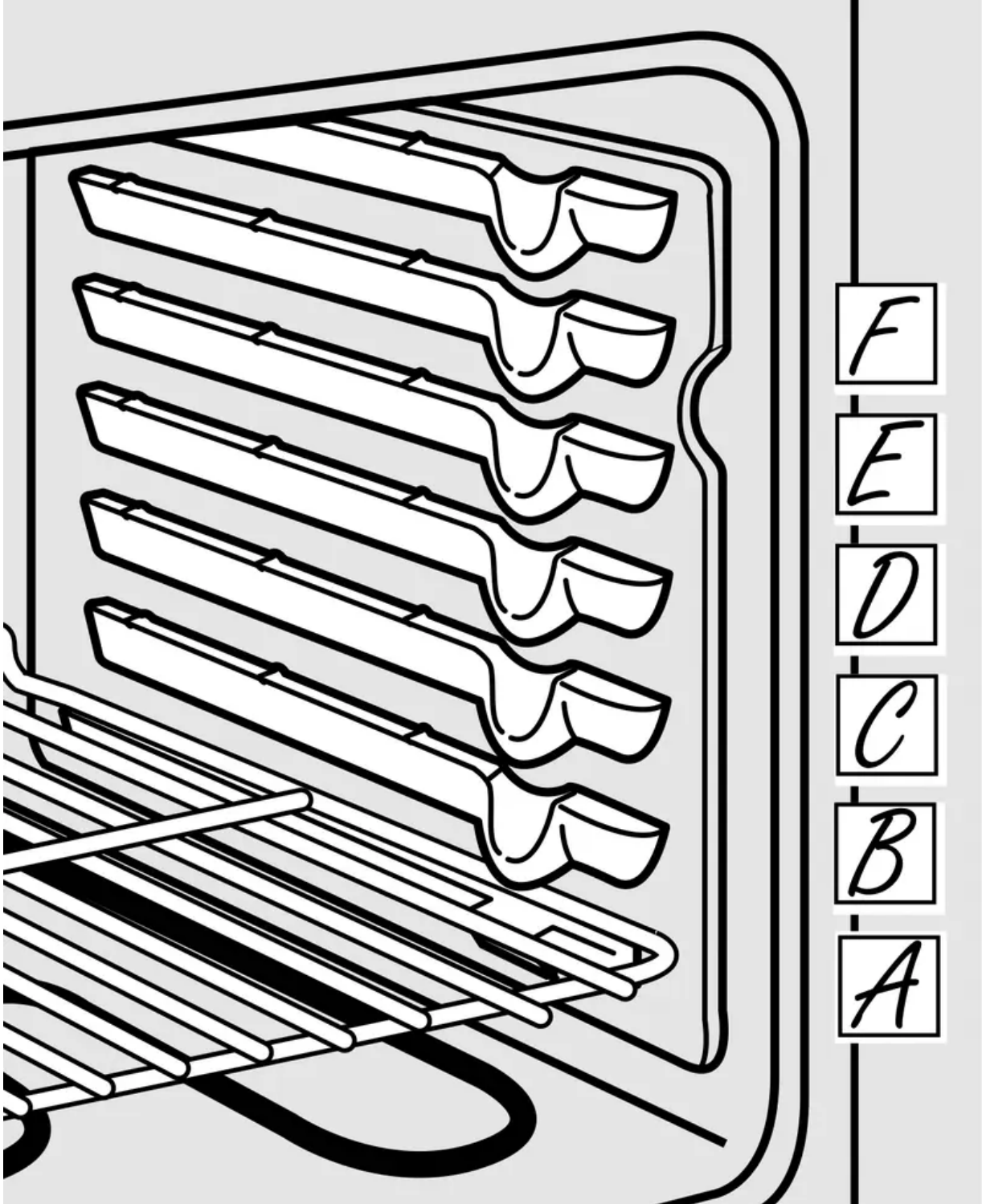

The oven has 6 shelf positions.

The shelves have stops, so that when placed correctly on the supports, they will stop before coming completely out, and will not tilt.

When placing and removing cookware, pull the shelf out until it stops.

To remove a shelf, pull it toward you, tilt the front end up and pull it out.

To replace, place the end of the shelf (stop-locks) on the support, tilt up the front and push the shelf in.

CAUTION: When you are using the shelf in the lowest position (A), you will need to use caution when pulling the shelf out. We recommend that you pull the shelf out several inches and then, using two pot holders, pull the shelf out by holding the sides of it. The shelf is low and you could be burned if you place your hand in the middle of the shelf and pull all the way out. Be very careful not to burn your hand on the door when using the shelf in the lowest position (A).

How to Set the Oven for Baking or Roasting

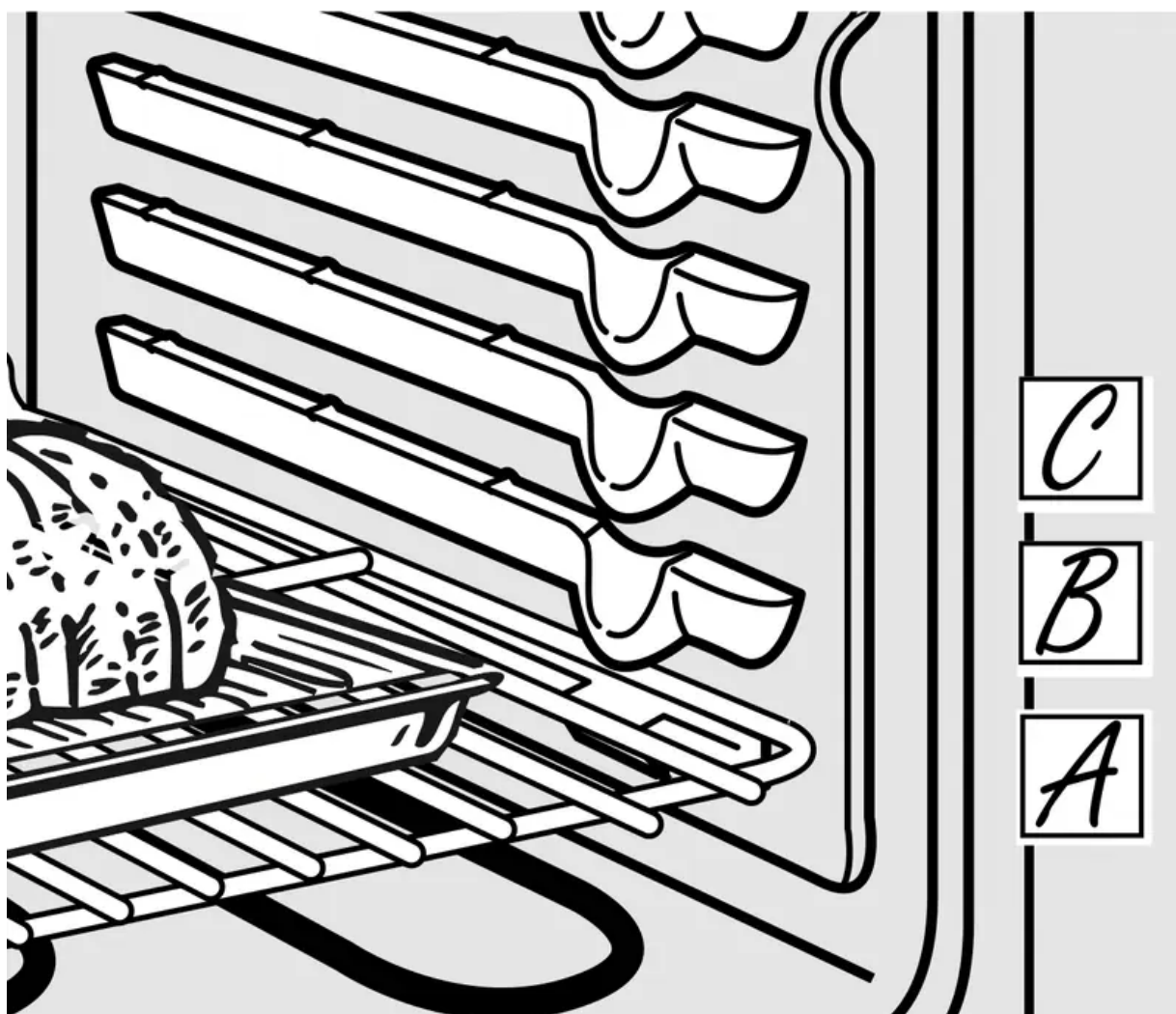

1. Press the **BAKE** pad.
2. Press the number pads to set the desired temperature.
3. Press the **START** pad.
4. Check food for doneness at minimum time on recipe. Cook longer if necessary.

5. Press the **CLEAR/OFF** pad when cooking is complete.

Type of Food	Shelf Position
Frozen pies (on cookie sheet)	D
Angel food cake, bundt or pound cakes	C or D
Biscuits, muffins, brownies, cookies, cupcakes, layer cakes, pies	C or D
Casseroles	C or D
Turkey	A

Preheating and Pan Placement

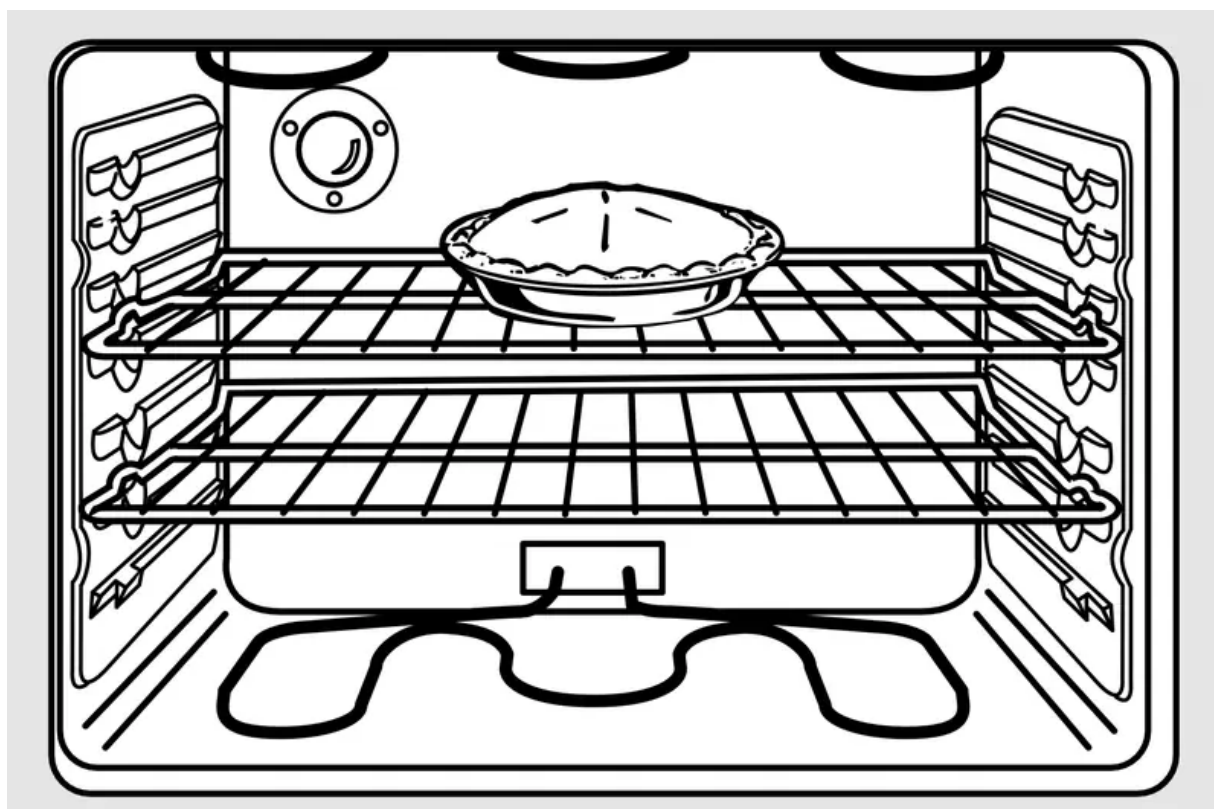

Center baking pans in the oven.

Preheat the oven if the recipe calls for it. Preheating is necessary for good results when baking cakes, cookies, pastry and breads.

To preheat, set the oven at the correct temperature. The control will beep when the oven is preheated and the display will show your set temperature. This will take approximately 15–20 minutes.

Baking results will be better if baking pans are centered in the oven as much as possible. If baking with more than one pan, place the pans so each has at least 1 to 1 1/2 " of air space around it. If baking four cake layers at the same time, place two layers on rack B and two layers on rack D. Stagger pans on the rack so one is not directly above the other.

Aluminum Foil

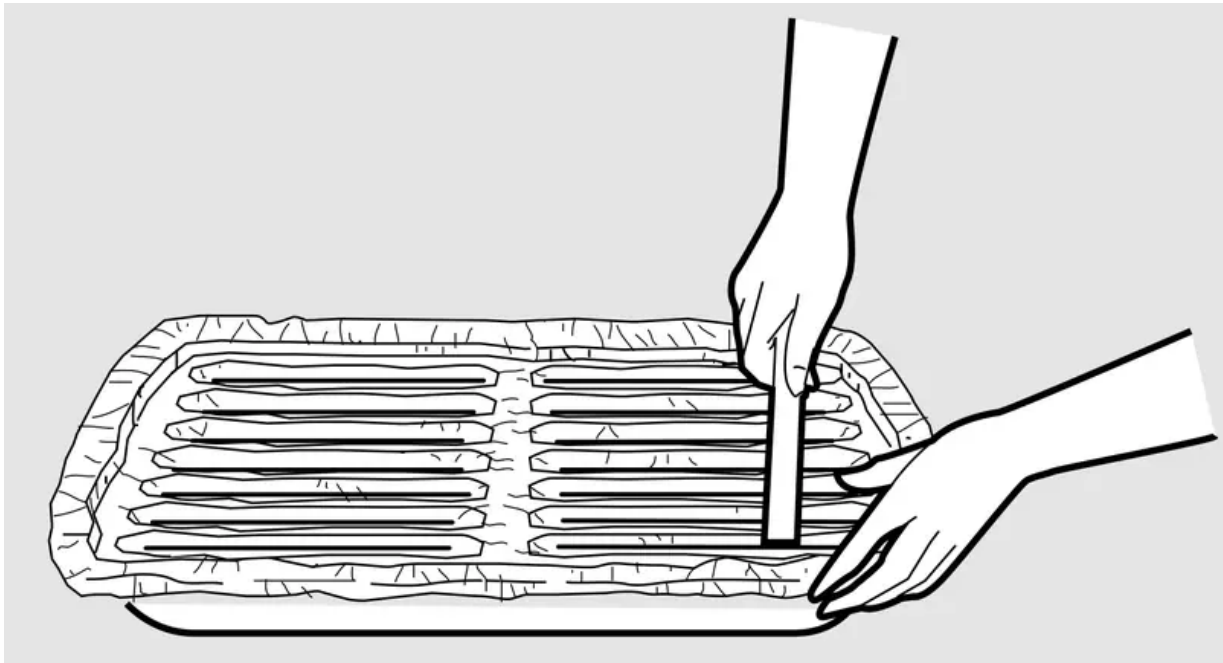

Cut slits in the foil just like the grid.

You can use aluminum foil to line the broiler pan and broiler grid. However, you must mold the foil tightly to the grid and cut slits in it just like the grid.

Without the slits, the foil will prevent fat and meat juices from draining into the broiler pan. The juices could become hot enough to catch on fire. If you do not cut the slits, you are essentially frying, not broiling.

Do not use aluminum foil on the bottom of the oven.

Never entirely cover a shelf with aluminum foil. This will disturb the heat circulation and result in poor baking.

A smaller sheet of foil may be used to catch a spillover by placing it on a lower shelf several inches below the food.

How to Set the Oven for Broiling

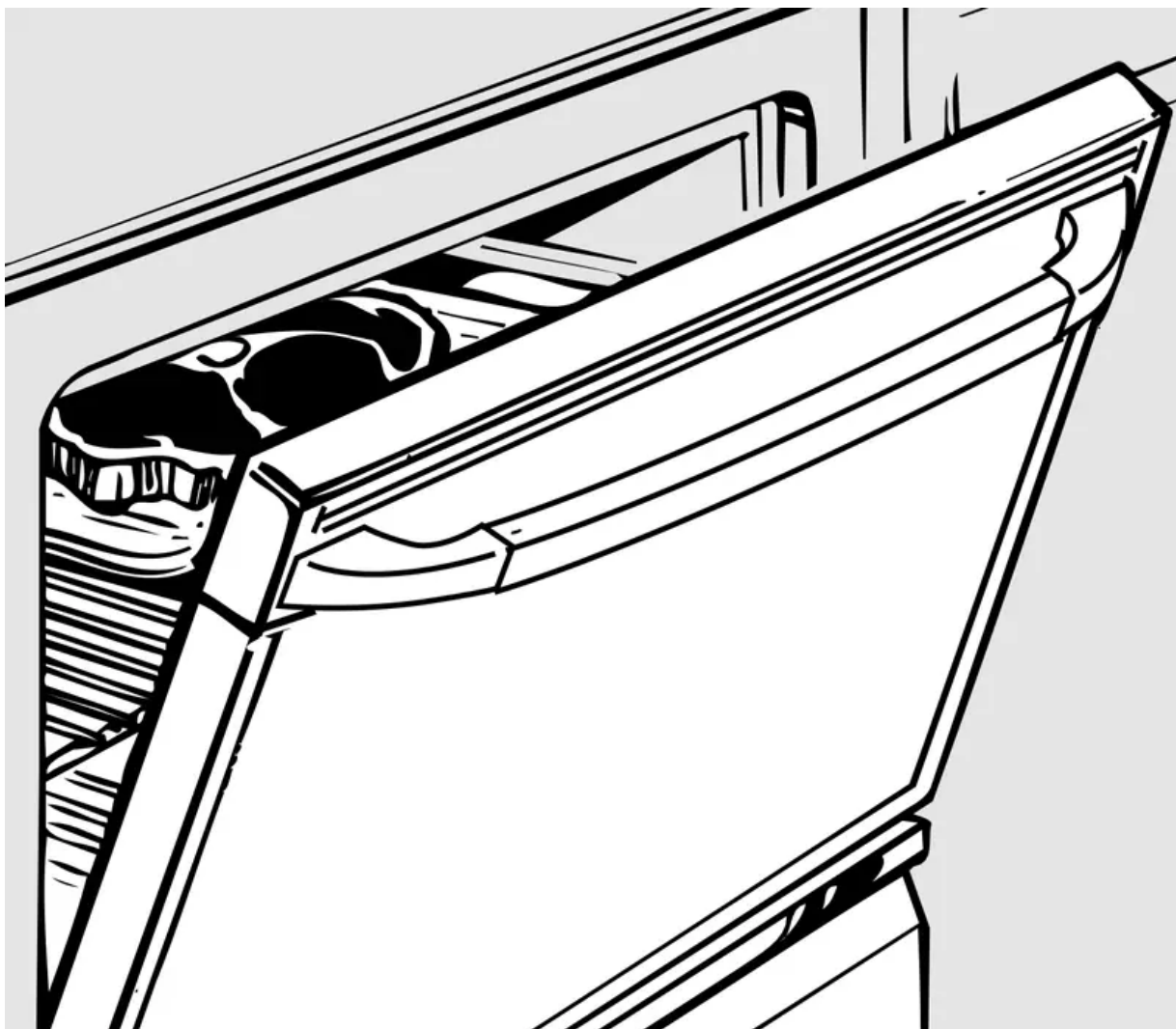

Leave the door open to the broil stop position. The door stays open by itself, yet the proper temperature is maintained in the oven.

1. Place the meat or fish on the broiler grid in the broiler pan.
2. Follow suggested shelf positions in the Broiling Guide. *If your range is connected to 208 volts, rare steaks may be broiled by preheating the broiler and positioning the oven shelf one position higher.* Use **LO Broil** to cook foods such as poultry or thick cuts of meat thoroughly without over-browning them.
3. Press the **BROIL HI/LO** pad once for **HI Broil**. To change to **LO Broil**, press the **BROIL HI/LO** pad again.
4. Press the **START** pad.
5. When broiling is finished, press the **CLEAR/OFF** pad.

Broiling Guide

The size, weight, thickness, starting temperature, and your preference of doneness will affect broiling times. This guide is based on meats at refrigerator temperature.

Food	Quantity and/ or Thickness	Shelf Position	First Side Time (min.)	Second Side Time (min.)	Comments	
Ground Beef	1 lb. (4 patties) 1/2 to 3/4" thick	D	13	8	Space evenly.	
	4 lbs. (12 patties)	D	15	11		
Beef Steaks	3/4 to 1" thick 1 to 1 1/2 lbs.	Rare†	F	6	4	Steaks less than 3/4" thick are difficult to cook rare. Slash fat.
		Medium	E	8	6	
		Well Done	E	10	8	
	1 1/2" thick 2 to 2 1/2 lbs.	Rare†	D	10	8	
		Medium	D	15	10–12	
		Well Done	E	20	20	
Chicken	1 whole cut up 2 to 2 1/2 lbs., split lengthwise Breast	C	25	25	Brush each side with melted butter. Broil skin-side-down first.	
		C	25	15		
Bakery Product	Bread (toast) English Muffin	2 to 4 slices	E	3	1	Space evenly. Place English muffins cut-side-up and brush with butter if desired.
		2 (split)	F	3-4		
Lobster Tails	2–4	C	18–20	Do not turn over.	Cut through back of shell. Spread open. Brush with melted butter before broiling and after half of broiling time.	
Fish Fillets	1 lb. (1/4 to 1/2" thick)	E	5	5	Handle and turn very carefully. Brush with lemon butter before and during cooking, if desired.	
Salmon	Steaks 2 (1" thick)	E	10	5	Turn carefully. Do not turn skin side down.	
		Fillet	E	10		
Ham Slices (precooked)	1/2" thick	D	6	6		
	1" thick	D	8	8		
Pork Chops	2 (1/2" thick)	D	10	10	Slash fat.	
	2 (1" thick) about 1 lb.	D	15	15		
Lamb Chops	2 (1" thick) about 10 to 12 oz.	Medium	E	7	4	Slash fat.
		Well Done	E	10	9	
	2 (1 1/2" thick) about 1 lb.	Medium	E	9	6	
		Well Done	E	14	10	

Using the clock and timer.

To Set the Clock

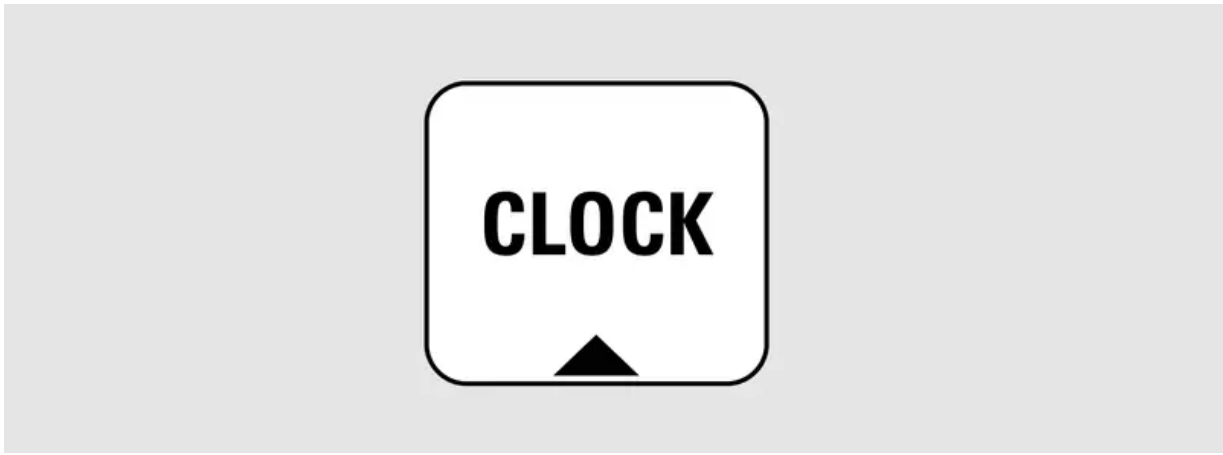

Make sure the clock is set to the correct time of day.

The clock must be set to the correct time of day for the automatic oven timing functions to work properly. The time of day cannot be changed during a timed baking or self-cleaning cycle.

1. Press the **CLOCK** pad.
2. Press the number pads.
3. Press the **START** pad.

To Set the Timer



The timer is a minute timer only.

The timer does not control oven operations. The maximum setting on the timer is 9 hours and 59 minutes.

1. Press the **KITCHEN TIMER ON/OFF** pad.
2. Press the number pads until the amount of time you want shows in the display. For example, to set 2 hours and 45 minutes, press **2**, **4** and **5** in that order. If you make a mistake press the **KITCHEN TIMER ON/OFF** pad and begin again.
3. Press the **START** pad.
4. When the timer reaches **:00**, the control will beep 3 times followed by one beep every 6 seconds until the **KITCHEN TIMER ON/OFF** pad is pressed.

The 6 second tone can be canceled by following the steps in the Special features of your oven control section under Tones at the End of a Timed Cycle.

To Reset the Timer

If the display is still showing the time remaining, you may change it by pressing the **KITCHEN TIMER ON/OFF** pad, then press the number pads until the time you want appears in the display.

If the remaining time is not in the display (clock, delay start or cooking time are in the display), recall the remaining time by pressing the **KITCHEN TIMER ON/OFF** pad and then pressing the number pads to enter the new time you want.

To Cancel the Timer

Press the **KITCHEN TIMER ON/OFF** pad twice.

Using the timed baking and roasting features.

NOTE: Foods that spoil easily—such as milk, eggs, fish, stuffings, poultry and pork—should not be allowed to sit for more than 1 hour before or after cooking. Room temperature promotes the growth of harmful bacteria. Be sure that the oven light is off because heat from the bulb will speed harmful bacteria growth.

How to Set an Immediate Start and Automatic Stop

BAKE



1

2

3

4

5

6

7

8

9

0

**COOKING
TIME**



1

2

3

4

5

6

7

8

9

0

START

The oven will turn on immediately and cook for a selected length of time. At the end of the cooking time the oven will turn off automatically.

1. Press the **BAKE** pad.
2. Using the number pads, enter the desired temperature.
3. Press the **COOKING TIME** pad. **NOTE:** If your recipe requires preheating, you may need to add additional time to the length of the cooking time.
4. Using the number pads, enter the desired baking time. The oven temperature and the cooking time that you entered will be displayed.
5. Press the **START** pad.

The word **ON** and **100°** will be displayed. The cook time will begin to count down. As the oven heats up, the display will show the changing temperature. When the oven reaches the temperature you set, 3 beeps will sound.

At the end of timed baking, the oven will turn off. The end of cycle tone will sound.

Press the **CLEAR/OFF** pad to clear the display.

How to Set a Delayed Start and Automatic Stop



BAKE



1

2

3

4

5

6

7

8

9

0

**COOKING
TIME**



1

2

3

4

5

6

7

8

9

0

**DELAY
START**



You can set the oven control to delay-start the oven, cook for a specific length of time and then turn off automatically.

Make sure the clock shows the correct time of day.

1. Press the **BAKE** pad.
2. Using the number pads, enter the desired temperature.
3. Press the **COOKING TIME** pad. **NOTE:** If your recipe requires preheating, you may need to add additional time to the length of the cooking time.
4. Using the number pads, enter the desired baking time.
5. Press the **DELAY START** pad.
6. Using the number pads, enter the time of day you want the oven to turn on and start cooking.
7. Press the **START** pad.

NOTE: An attention tone will sound if you are using timed baking and do not press the **START** pad after entering the baking temperature.

If you would like to check the times you have set, press the **DELAY START** pad to check the start time you have set or press the **COOKING TIME** pad to check the length of cooking time you have set.

The oven will turn on automatically. The word **ON** and **100°** will be displayed. The cook time will begin to count down.

As the oven heats up, the display will show the changing temperature. The oven will cook for the programmed cooking time and shut off automatically.

At the end of timed baking, the oven will turn off. The end of cycle tone will sound.

Press the **CLEAR/OFF** pad to clear the display.

Using the Sabbath Feature. (Designed for use on the Jewish Sabbath and Holidays)

(On some models)

The Sabbath feature can be used for baking/roasting only. It cannot be used for broiling, self-cleaning, or Delay Start cooking.

NOTE: The oven light comes on automatically (on some models) when the door is opened and goes off when the door is closed. The bulb may be removed. See the Oven Light Replacement section. On models with a light switch on the control panel, the oven light may be turned on and left on.

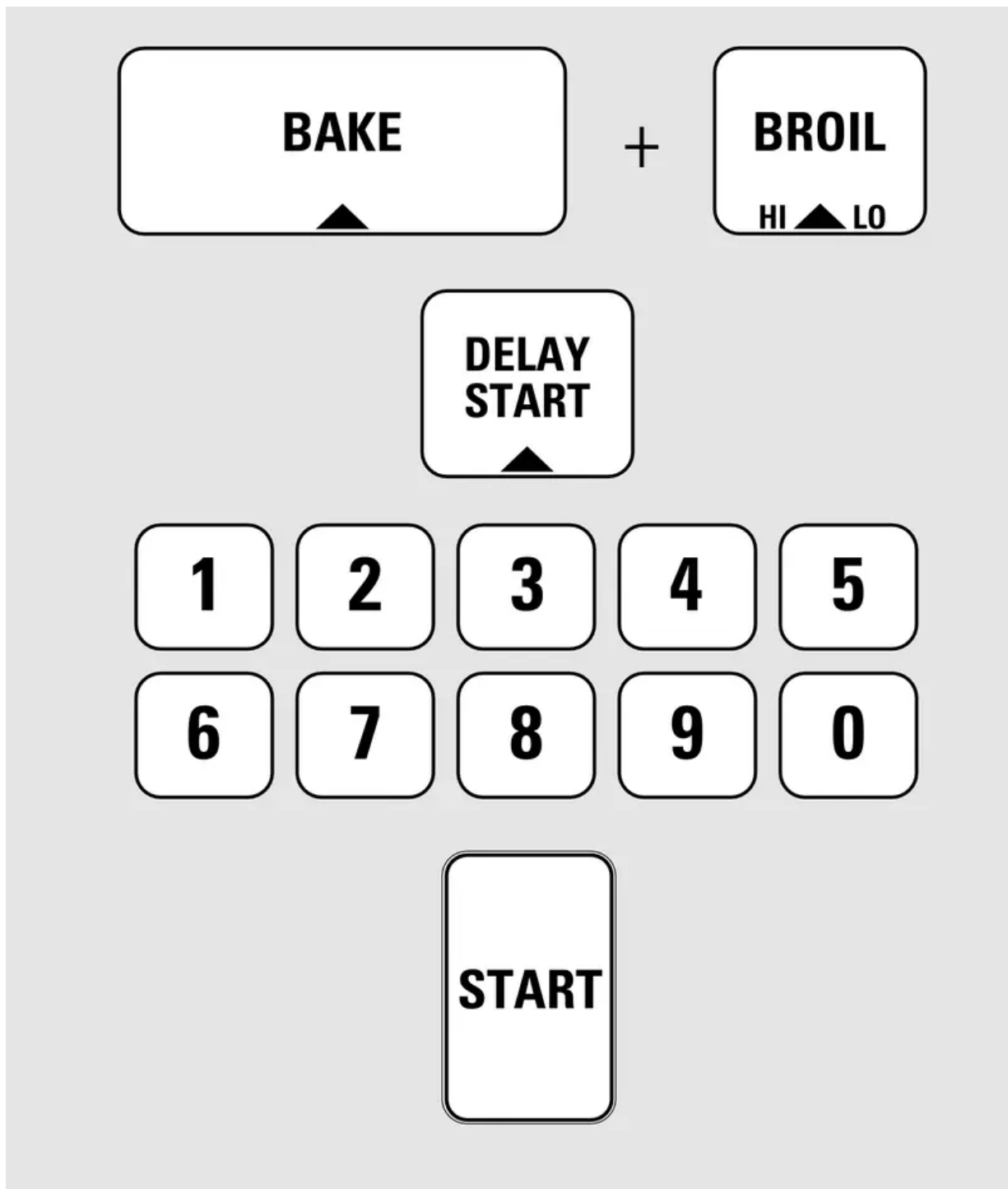

How to Set for Regular Baking/Roasting



When the display shows \supset the oven is set in Sabbath. When the display shows $\supset \subset$ the oven is baking/roasting.

Make sure the clock shows the correct time of day.

1. Press and hold **both** the **BAKE** and **BROIL HI/LO** pads, **at the same time**, until the display shows **SF**.
2. Tap the **DELAY START** pad until **SAb bAtH** appears in the display.
3. Touch the **START** pad and \supset will appear in the display.



4. Touch the **BAKE** pad. No signal will be given.
5. Using the number pads, enter the desired temperature between 170° and 550°. No signal or temperature will be given.
6. Touch the **START** pad.
7. After a random delay period of approximately 30 seconds to 1 minute,  will appear in the display indicating that the oven is baking/roasting. If  doesn't appear in the display, start again at Step 4.

To adjust the oven temperature, touch the **BAKE** pad, enter the new temperature using the number pads, and touch the **START** pad.



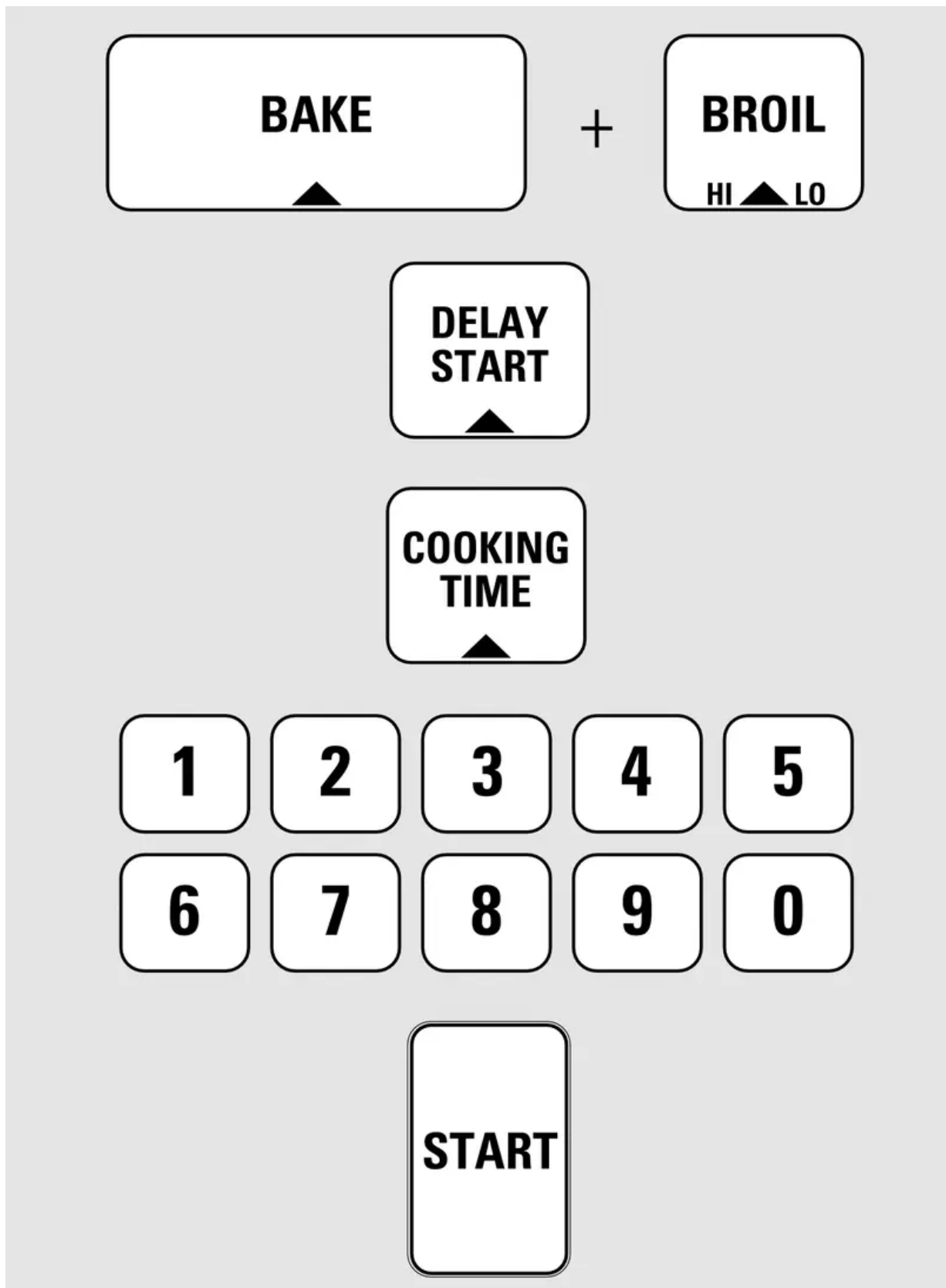

NOTE: The **CLEAR/OFF** and **COOKING TIME** pads are active during the Sabbath feature.

How to Set for Timed Baking/Roasting—Immediate Start and Automatic Stop





When the display shows  the oven is set in Sabbath. When the display shows  the oven is baking/roasting.

Make sure the clock shows the correct time of day.

1. Press and hold **both** the **BAKE** and **BROIL HI/LO** pads, at the same time, until the display shows **SF**.
2. Tap the **DELAY START** pad until **SAb bAtH** appears in the display.
3. Touch the **START** pad and  will appear in the display.
4. Touch the **COOKING TIME** pad.
5. Touch the number pads to set the desired length of cooking time between 1 minute and 9 hours and 99 minutes. The cooking time that you entered will be displayed.
6. Touch the **START** pad.
7. Touch the **BAKE** pad. No signal will be given.
8. Using the number pads, enter the desired temperature. No signal or temperature will be given.
9. Touch the **START** pad.
10. After a random delay period of approximately 30 seconds to 1 minute,   will appear in the display indicating that the oven is baking/roasting. If   doesn't appear in the display, start again at Step 7.

To adjust the oven temperature, touch the **BAKE** pad, enter the new temperature using the number pads, and touch the **START** pad.

When cooking is finished, the display will change from   to  and **0:00** will appear, indicating that the oven has turned **OFF** but is still set in Sabbath. Remove the cooked food.

How to Exit the Sabbath Feature

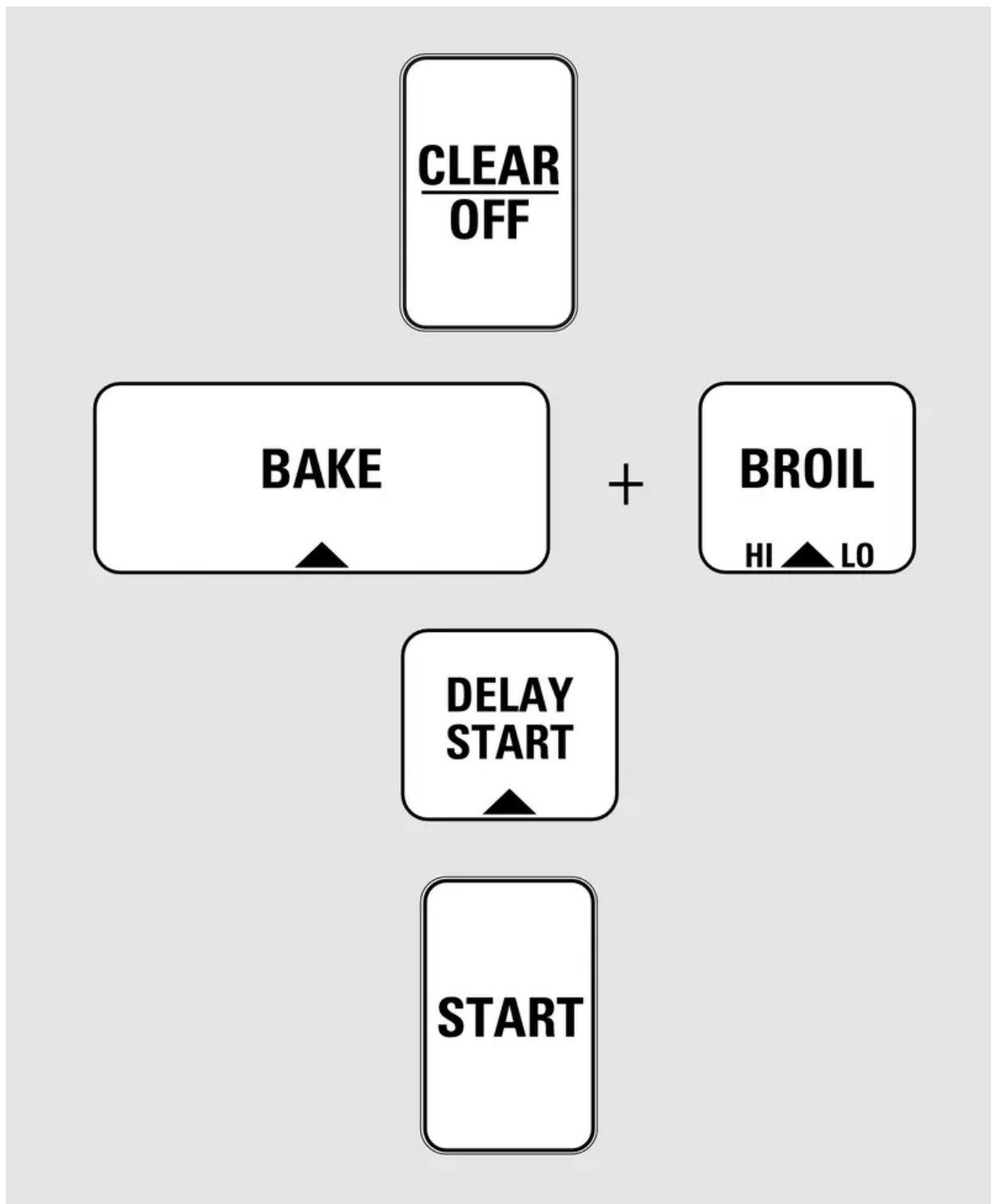

1. Touch the **CLEAR/OFF** pad.
2. If the oven is cooking, wait for a random delay period of approximately 30 seconds to 1 minute, until only  is in the display.
3. Press and hold both the **BAKE** and **BROIL HI/LO** pads, **at the same time**, until the display shows **SF**.

4. Tap the **DELAY START** pad until 12 shdn or no shdn appears in the display. **12 shdn** indicates that the oven will automatically turn off after 12 hours. **no shdn** indicates that the oven will not automatically turn off.
5. Touch the **START** pad.

NOTE: If a power outage occurred while the oven was in Sabbath, the oven will automatically turn off and stay off even when the power returns. The oven control must be reset.

Adjust the oven thermostat—Do it yourself!

You may find that your new oven cooks differently than the one it replaced. Use your new oven for a few weeks to become more familiar with it. If you still think your new oven is too hot or too cold, you can adjust the thermostat yourself.

Do not use thermometers, such as those found in grocery stores, to check the temperature setting of your oven. These thermometers may vary 20–40 degrees.

NOTE: This adjustment will not affect the broiling or the self-cleaning temperatures. The adjustment will be retained in memory after a power failure.

To Adjust the Thermostat

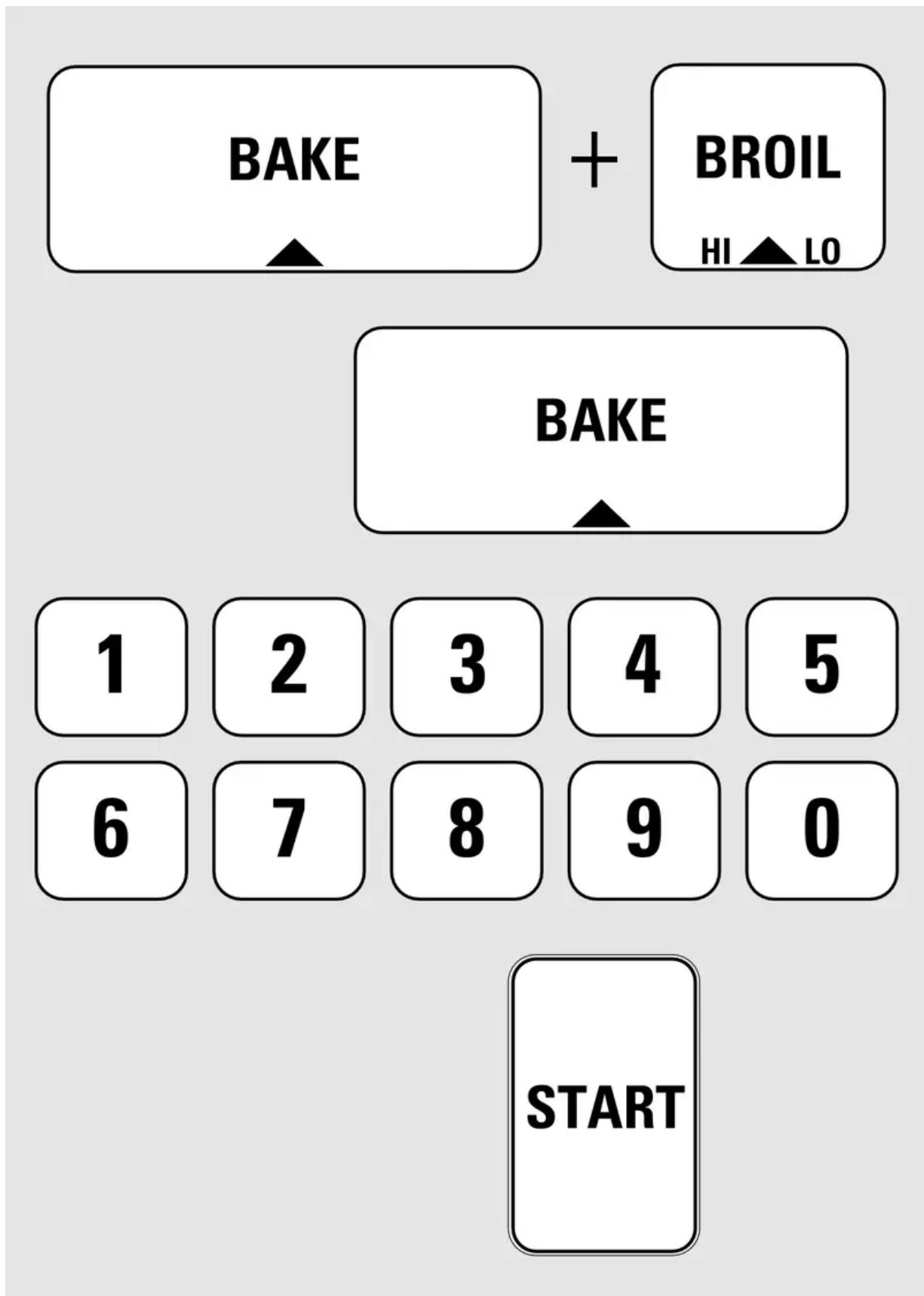

1. Press the **BAKE** and **BROIL HI/LO** pads at the same time for 3 seconds until the display shows **SF**.

2. Press the **BAKE** pad. A two digit number shows in the display. Press **BAKE** once to decrease (-) the oven temperature, or twice to increase (+).
3. The oven temperature can be adjusted up as much as 35°F. or down as much as 35°F. Press the number pads the same way you read them. For example, to change the oven temperature 15°F., press **1** and **5**.
4. When you have made the adjustment, press the **START** pad to go back to the time of day display. Use your oven as you would normally.

Care and Cleaning

Before a Clean Cycle

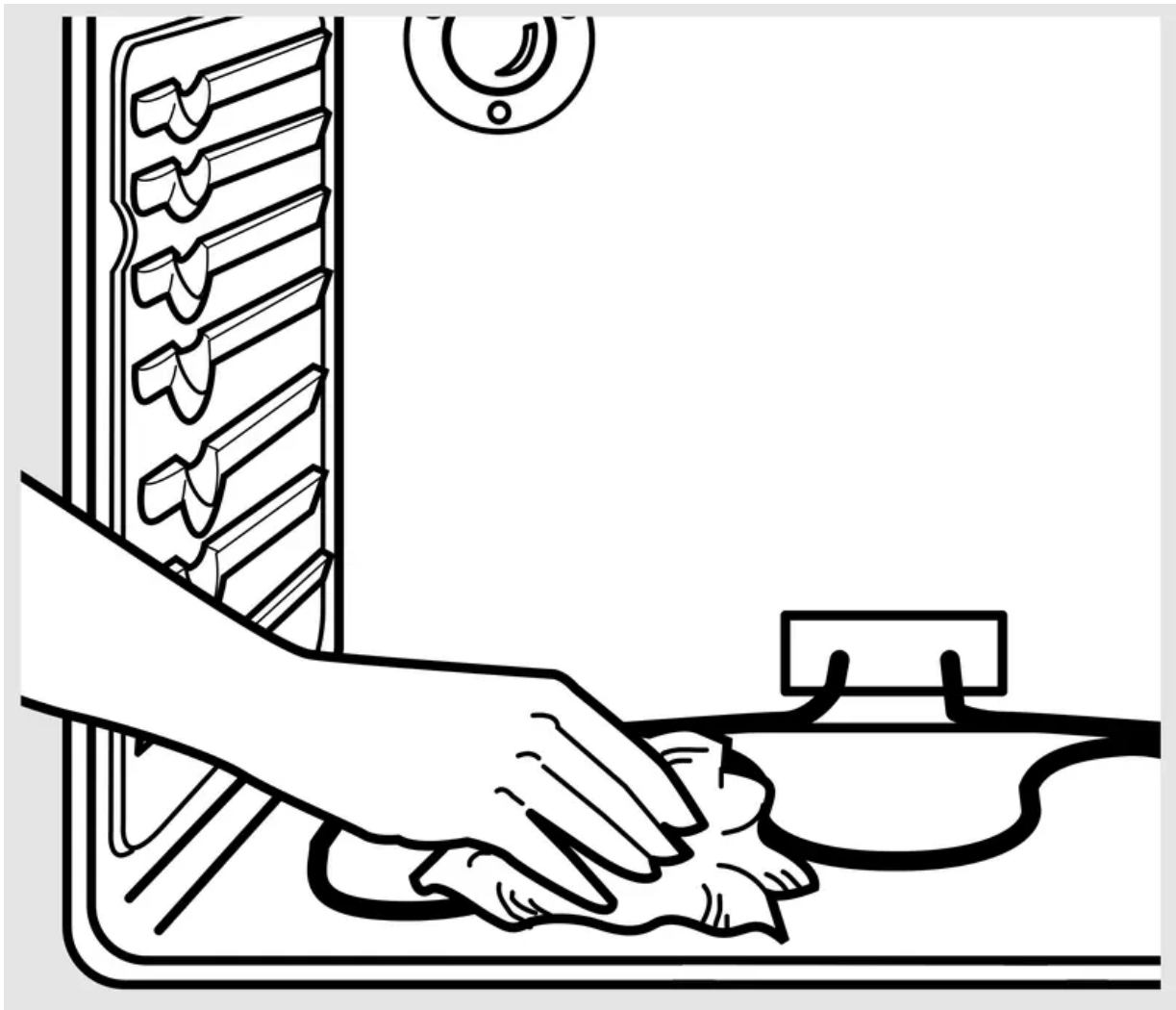

Wipe up heavy soil on the oven bottom.

We recommend venting your kitchen with an open window or using a ventilation fan or hood during the first self-clean cycle.

Remove the shelves, broiler pan, broiler grid, all cookware and any aluminum foil from the oven.

The oven shelves can be self-cleaned, but they will darken, lose their luster and become hard to slide.

Soil on the front frame of the range and outside the gasket on the door will need to be cleaned by hand. Clean these areas with hot water, soap-filled steel-wool pads or cleansers such as Soft Scrub®. Rinse well with clean water and dry.

Do not clean the gasket. The fiberglass material of the oven door gasket cannot withstand abrasion. It is essential for the gasket to remain intact. If you notice it becoming worn or frayed, replace it.

Wipe up any heavy spillovers on the oven bottom.

Make sure the oven light bulb cover is in place and the oven light is off.

IMPORTANT: The health of some birds is extremely sensitive to the fumes given off during the self-cleaning cycle of any range. Move birds to another well ventilated room.

How to Set the Oven for Cleaning

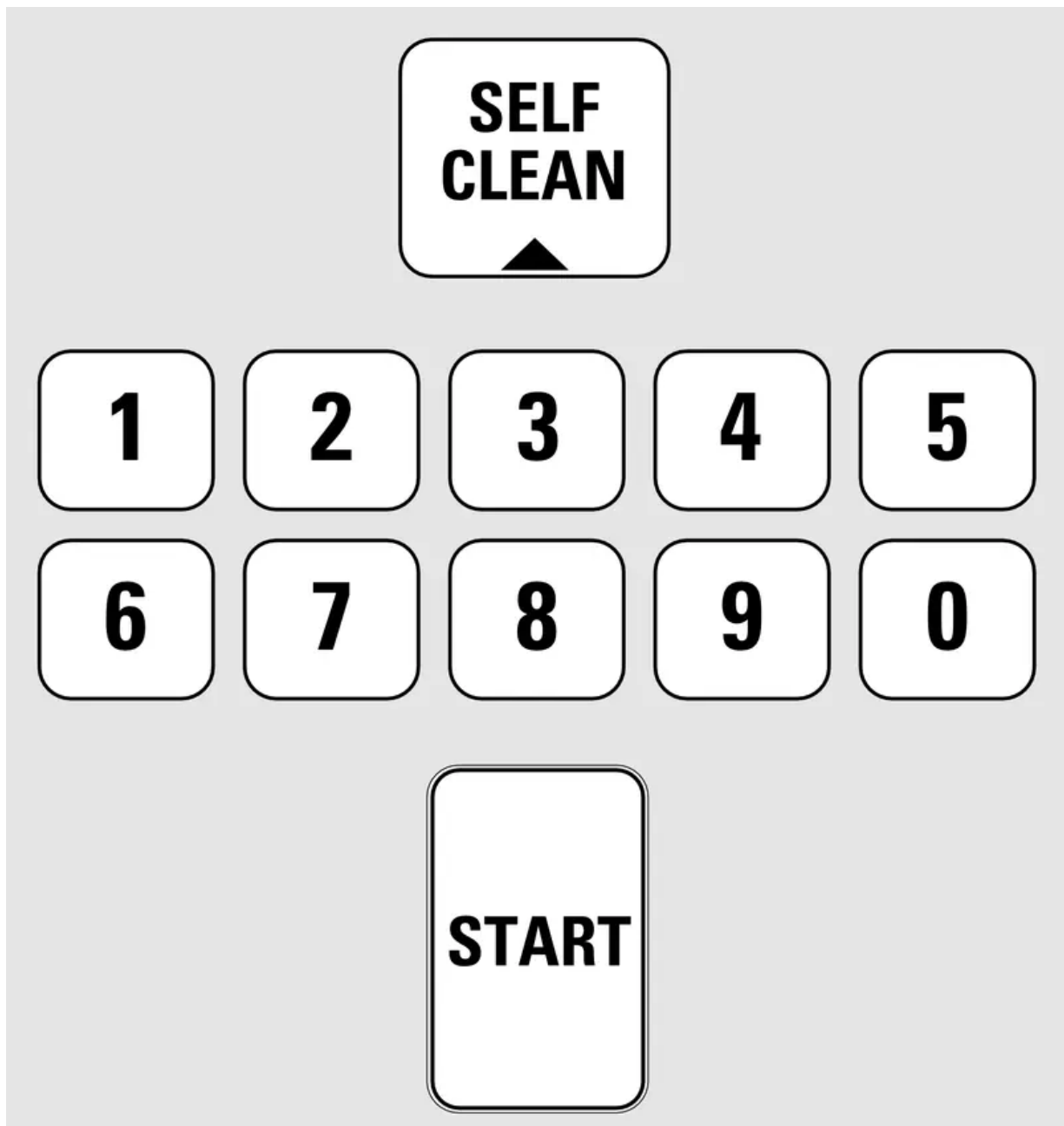

1. Touch the **SELF CLEAN** pad.
2. Using the number pads, enter the desired clean time, if a time other than 4 hours is needed. Clean cycle time is normally 4 hours. You can change the clean time to any time between 3 hours and 5 hours, depending on how dirty your oven is.
3. Touch the **START** pad.

The door locks automatically. The display will show the clean time remaining. It will not be possible to open the oven door until the temperature drops below the lock temperature and the **LOCKED DOOR** light goes off.

When the **LOCKED DOOR** light is off, open the door.

The oven shuts off automatically when the clean cycle is complete.

- The words **LOCK DOOR** will flash and the oven control will signal if you set the clean cycle and forget to close the oven door.
- To stop a clean cycle, touch the **CLEAR/OFF** pad. When the **LOCKED DOOR** light goes off indicating the oven has cooled below the locking temperature, open the door.

How to Delay the Start of Cleaning

**SELF
CLEAN**



1

2

3

4

5

6

7

8

9

0

**DELAY
START**



1

2

3

4

5

6

7

8

9

0

START

Make sure the clock shows the correct time of day.

1. Touch the **SELF CLEAN** pad.
2. Using the number pads, enter the desired clean time.
3. Touch the **DELAY START** pad. The earliest start time you can set will appear in the display.
4. Using the number pads, enter the time of day you want the clean cycle to start.
5. Touch the **START** pad.

The door locks automatically. The display will show the start time. It will not be possible to open the oven door until the temperature drops below the lock temperature and the **LOCKED DOOR** light goes off.

When the **LOCKED DOOR** light is off, open the door.

After a Clean Cycle

You may notice some white ash in the oven. Wipe it up with a damp cloth after the oven cools.

If white spots remain, remove them with a soapfilled steel wool pad and rinse thoroughly with a vinegar and water mixture.

These deposits are usually a salt residue that cannot be removed by the clean cycle.

If the oven is not clean after one clean cycle, repeat the cycle.

- You cannot set the oven for cooking until the oven is cool enough for the door to be unlatched.
- While the oven is self-cleaning, you can press the **CLOCK** pad to display the time of day. To return to the clean countdown, press the **COOKING TIME** pad.
- If the shelves become hard to slide, apply a small amount of vegetable oil or cooking oil to a paper towel and wipe the edges of the oven shelves with the paper towel.

Care and cleaning of the range.

Be sure all controls are off and all surfaces are cool before cleaning any part of the range.

If your range is removed for cleaning, servicing or any reason, be sure the anti-tip device is re-engaged properly when the range is replaced. Failure to take this precaution could result in tipping of the range and cause injury.

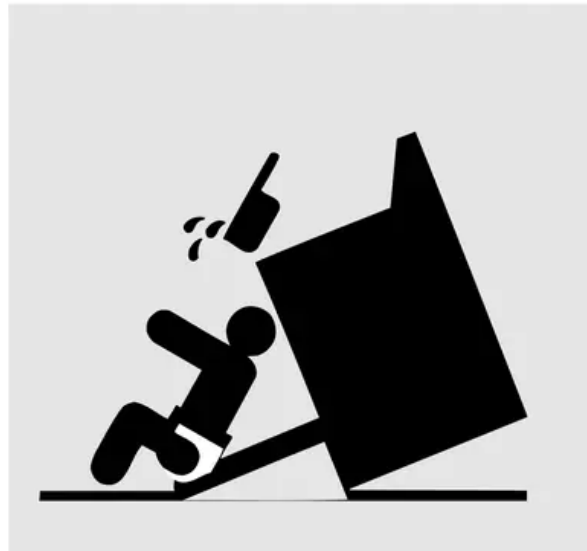

How to Remove Packaging Tape

To assure no damage is done to the finish of the product, the safest way to remove the adhesive left from packaging tape on new appliances is an application of a household liquid dishwashing detergent, mineral oil or cooking oil.

Apply with a soft cloth and allow to soak. Wipe dry and then apply an appliance polish to thoroughly clean and protect the surface.

NOTE: The plastic tape (on some models) must be removed from all chrome trim. It cannot be removed if it is baked on.

Control Knobs

The control knobs may be removed for easier cleaning.

Before removing the knobs for cleaning, please note that the knobs are in the OFF position. When replacing the knobs, check the OFF position to insure proper placement.

Wash the knobs in soap and water or a vinegar and hot water solution but do not soak.

The knob stem has a groove in each side. The groove on one side has a spring clip. The other groove is clear (see illustration). Check the inside of the knob and find the molded rib.

Replace the knob by fitting the molded rib inside the knob into the clear groove on the stem.

Groove Stem

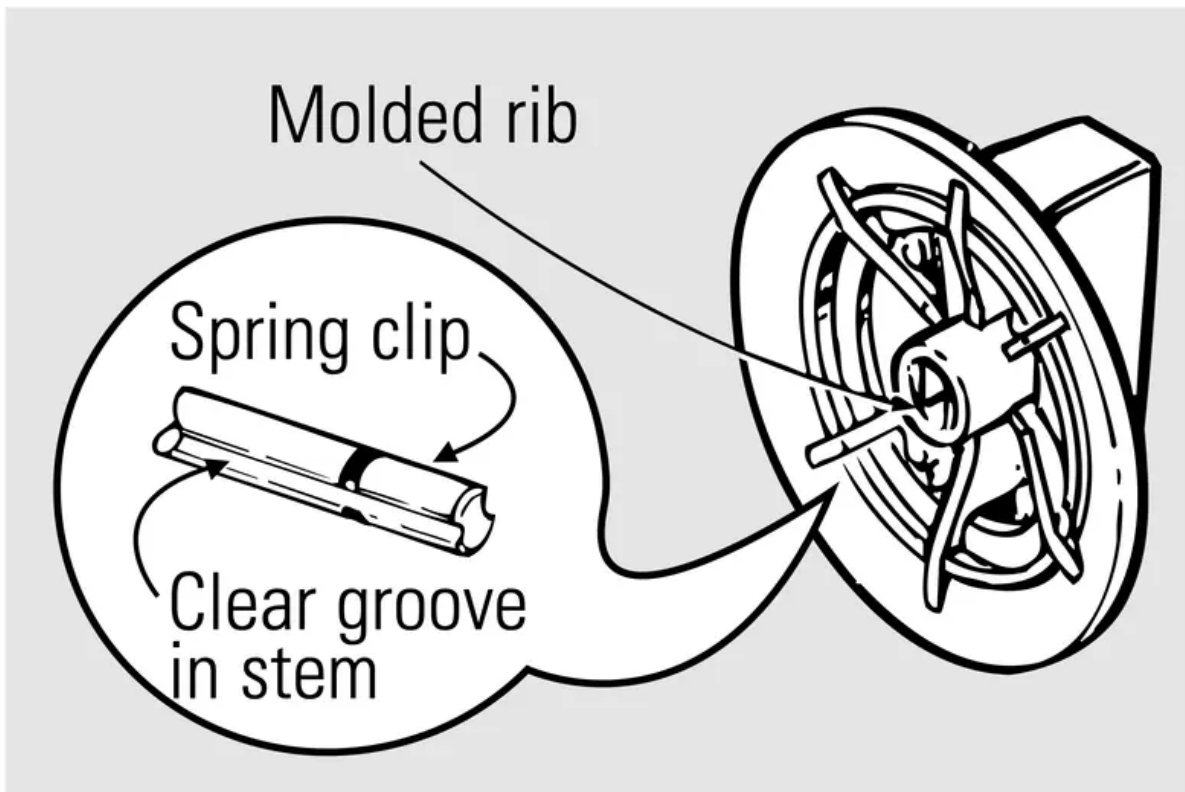

The knob stem is flat on one side (see illustration). Check the inside of the knob and find the molded flat area.

Replace the knob by fitting the molded flat area inside the knob onto the flat area of the stem.

Flat Stem

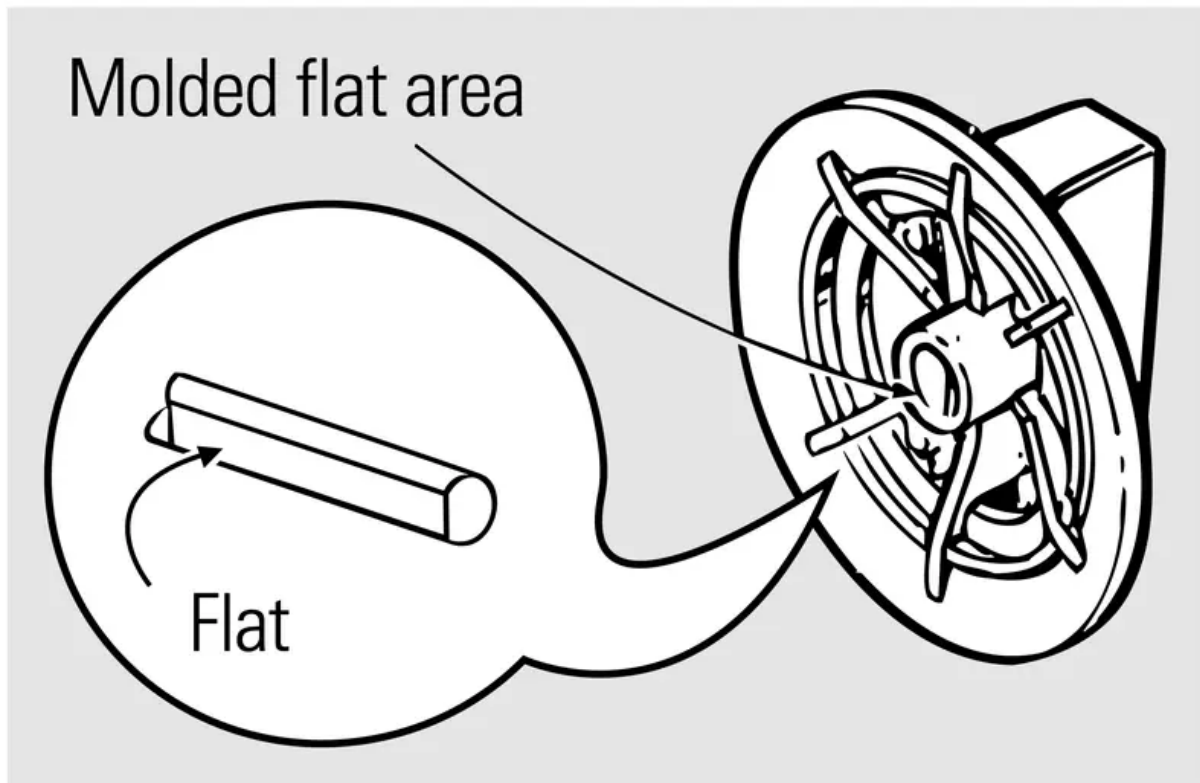

Oven Vent



The oven vent is located behind the right rear surface unit.

This area could become hot during oven use.

It is normal for steam to come out of the vent and moisture may collect underneath it when the oven is in use.

The vent is important for proper air circulation. Never block this vent.

Painted Surfaces

Painted surfaces include the sides of the range and the door, top of control panel and the drawer front. Clean these with soap and water or a vinegar and water solution.

Do not use commercial oven cleaners, cleaning powders, steel wool or harsh abrasives on any painted surface.

Control Panel

- Clean up splatters with a damp cloth.
- You may also use a glass cleaner.
- Remove heavier soil with warm soapy water.
- Do not use abrasives of any kind.

Lift-Off Oven Door

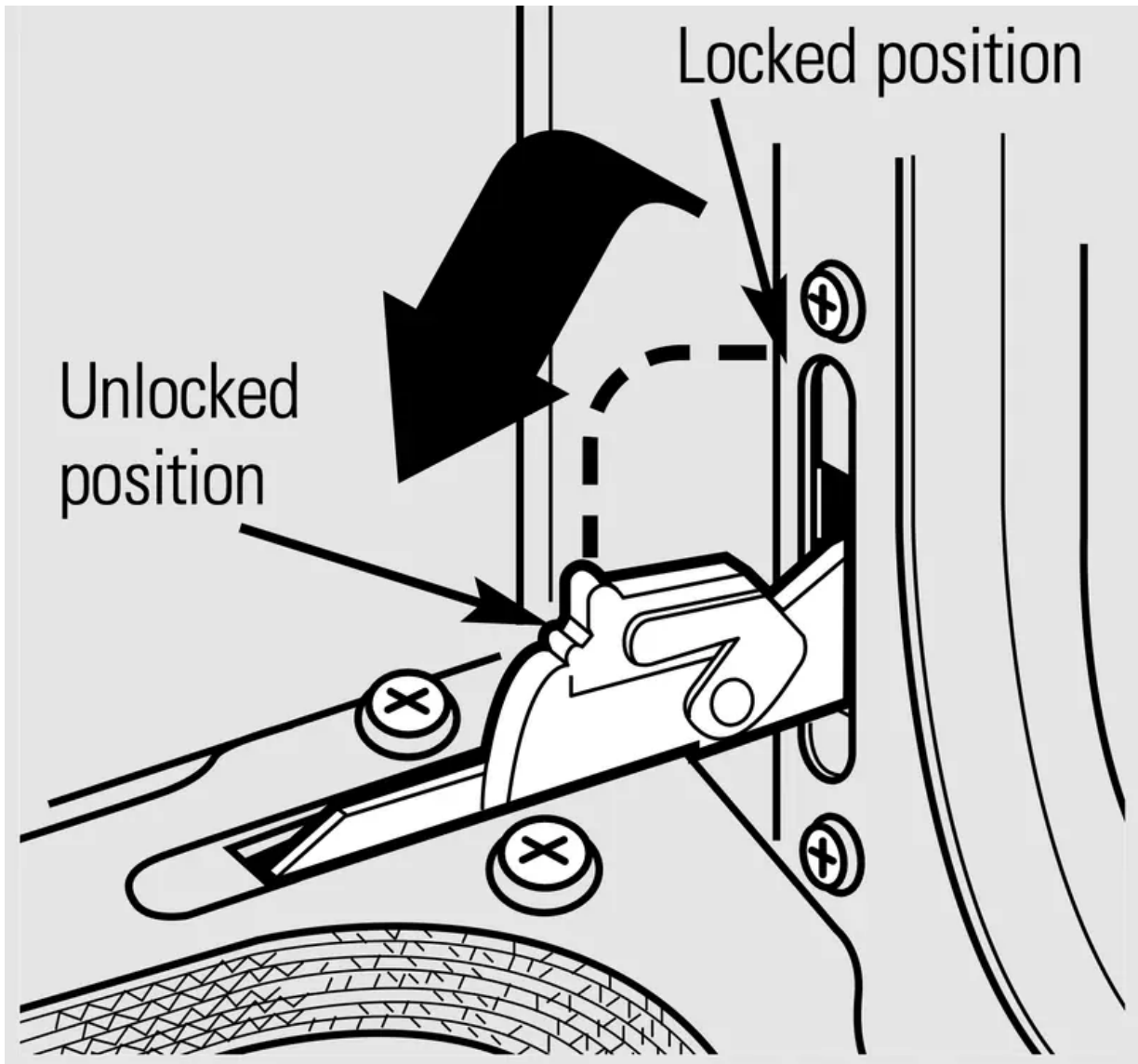

Pull the hinge locks down to the unlocked position.

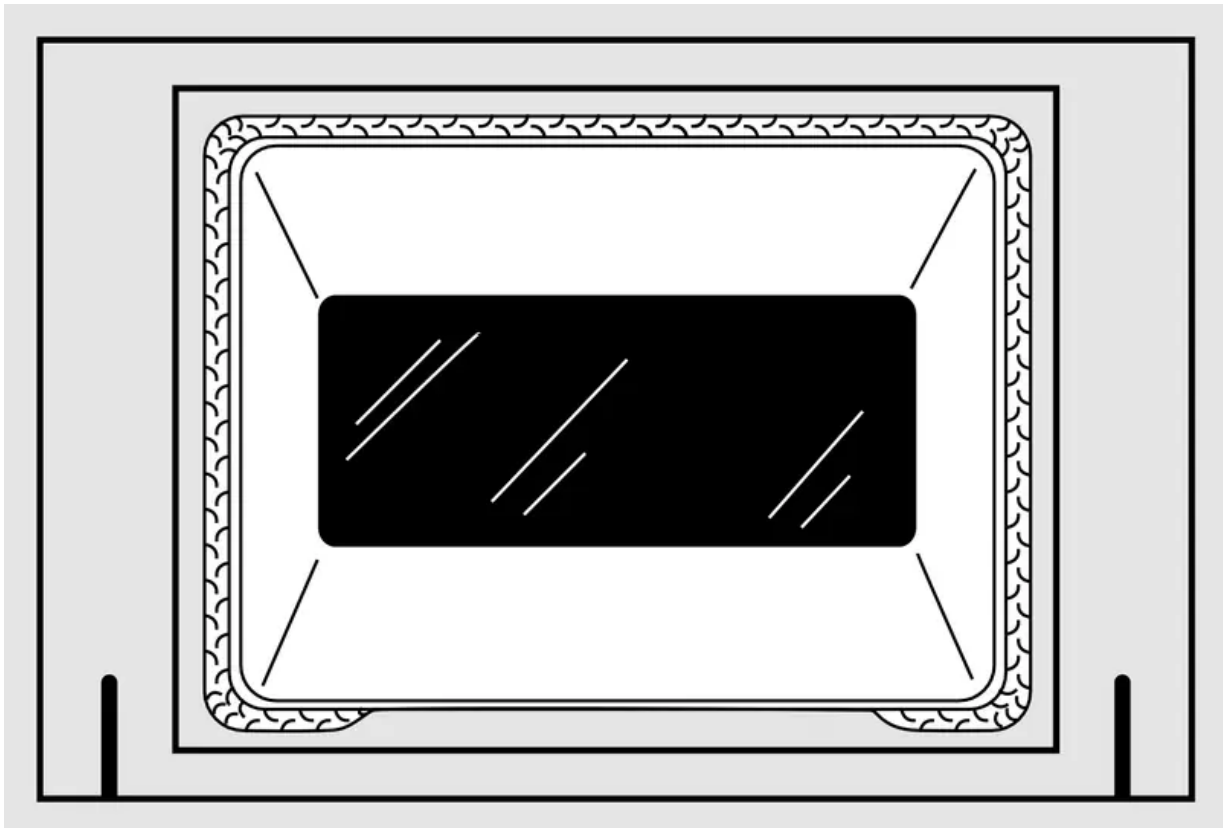

The gasket is designed with a gap at the bottom to allow for proper air circulation.

Do not rub or clean the door gasket—it has an extremely low resistance to abrasion.

If you notice the gasket becoming worn, frayed or damaged in any way or if it has become displaced on the door, you should have it replaced.

The oven door is removable for easier access to the light bulb.

Do not lift the door by the handle.

To remove the door:

1. Fully open the door.
2. Each hinge has a hinge lock. Using a tool, pull the hinge locks down against the door frame.
3. Firmly grasp the door **at the top sides**.
4. Close the door to the stop position.
5. Lift the door up and pull straight out.

To replace the door:

1. Firmly grasp the door at the top sides. This is critical.
2. Approach the range with the door angled in a vertical position.

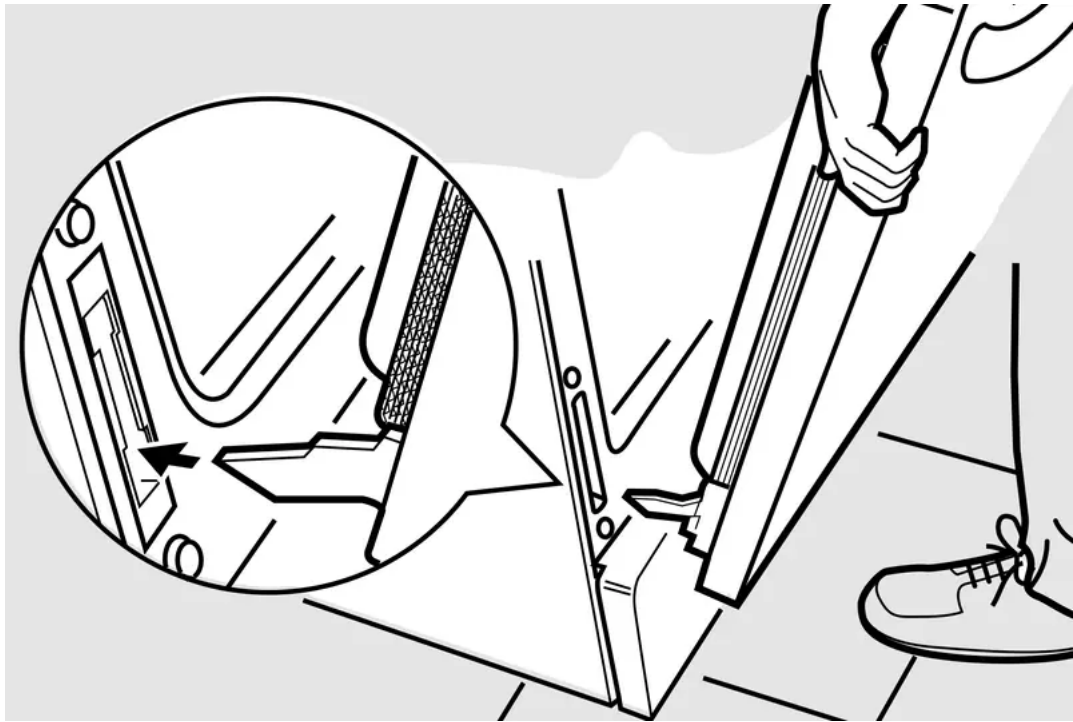

3. Guide the hinges into the slots.
4. Push door in firmly while opening.
5. Once in position, open the door completely. Push the hinge locks back in towards the front frame.

To clean the inside of the door:

- Because the area inside the gasket is cleaned during the self-clean cycle, you do not need to clean this by hand.
- The area outside the gasket and the door liner can be cleaned with a soapfilled steel wool or plastic pad, hot water and detergent. Rinse well with a vinegar and water solution.

To clean the outside of the door:

- Use soap and water to thoroughly clean the top, sides and front of the oven door. Rinse well. You may also use a glass cleaner to clean the glass on the outside of the door. Do not let water drip into the vent openings.
- If any stain on the door vent trim is persistent, use a soft abrasive cleaner and a sponge-scrubber for best results.
- Spillage of marinades, fruit juices, tomato sauces and basting materials containing acids may cause discoloration and should be wiped up immediately. When surface is cool, clean and rinse.
- Do not use oven cleaners, cleaning powders or harsh abrasives on the outside of the door.

Oven Shelves

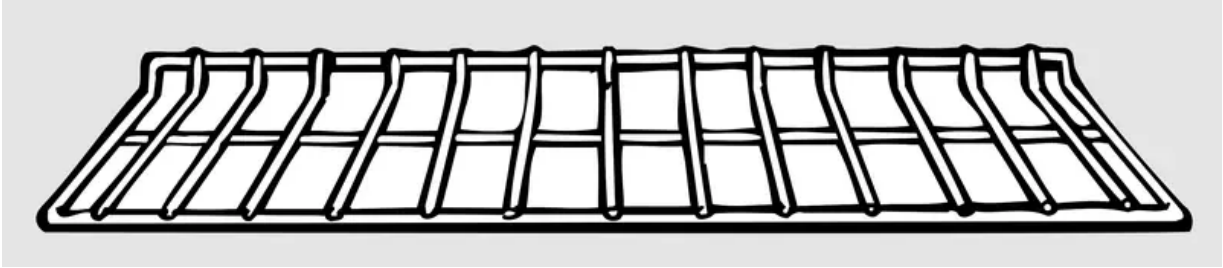

NOTE: The oven shelves may be cleaned in the self-cleaning oven. However, the shelves will darken in color, lose their luster and become hard to slide if cleaned during the self-cleaning cycle.

Clean the oven shelves with an abrasive cleanser or steel wool. After cleaning, rinse the shelves with clean water and dry with a clean cloth.

To make the shelves slide more easily, apply a small amount of vegetable oil or cooking oil to a paper towel and wipe the edges of the oven shelves with the paper towel.

Storage Drawer Removal

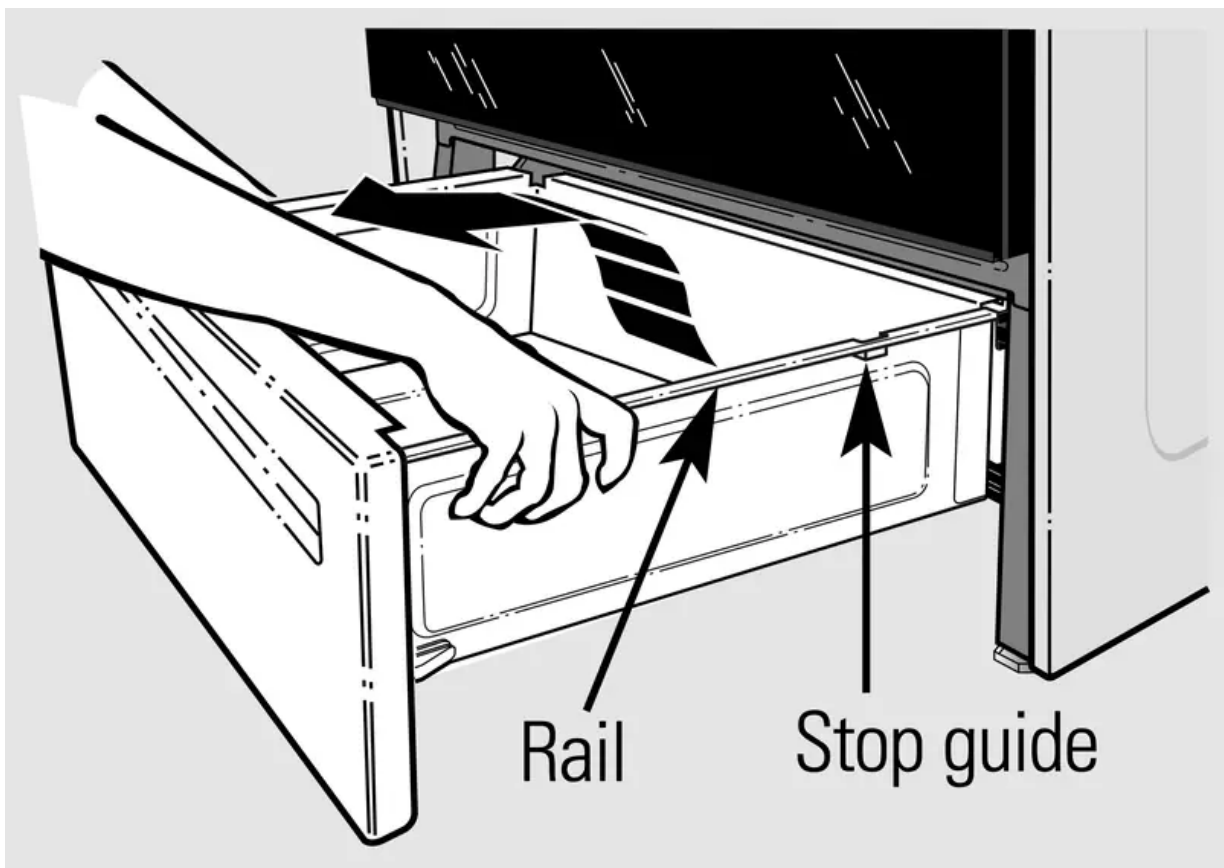

To remove the drawer:

1. Pull the drawer out until it stops.
2. Lift the front of the drawer until the stops clear the guides.
3. Remove the drawer.

To replace the drawer:

1. Place the drawer rails on the guides.
2. Push the drawer back until it stops.
3. Lift the front of the drawer and push back until the stops clear the guides.
4. Lower the front of the drawer and push back until it closes.

Broiler Pan & Grid

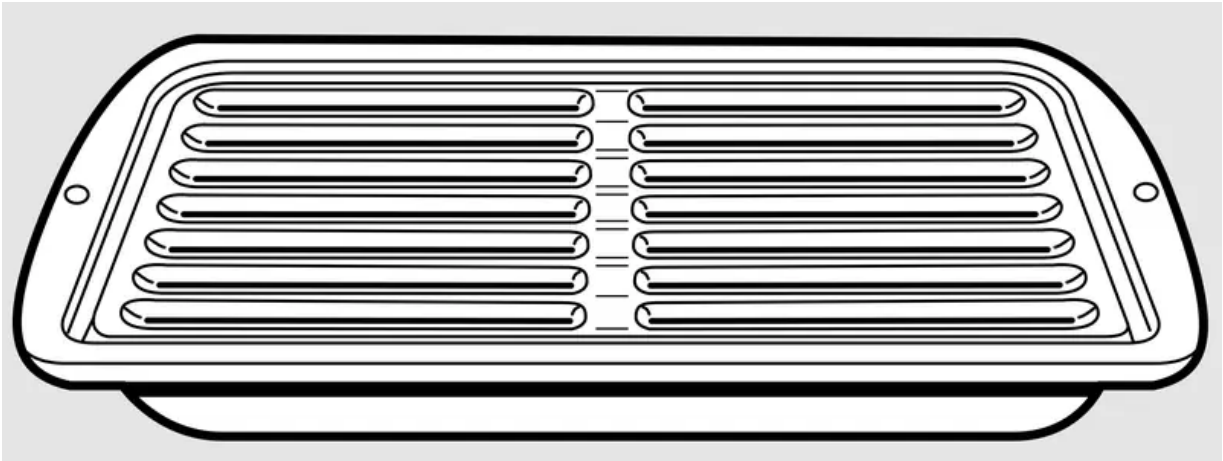

After broiling, remove the broiler pan from the oven. Do not store a soiled broiler pan and grid anywhere in the range.

Do not clean the broiler pan or grid in a self-cleaning oven.

After broiling, remove the broiler pan from the oven. Remove the grid from the pan. Carefully pour out the grease from the pan into a proper container.

Wash and rinse the broiler pan and grid in hot water with a soap-filled or plastic scouring pad.

If food has burned on, sprinkle the grid with detergent while hot and cover with wet paper towels or a dishcloth. Soaking the pan will remove burned-on foods.

Both the broiler pan and grid may be cleaned with a commercial oven cleaner.

Both the broiler pan and grid can also be cleaned in a dishwasher.

Oven Light Replacement

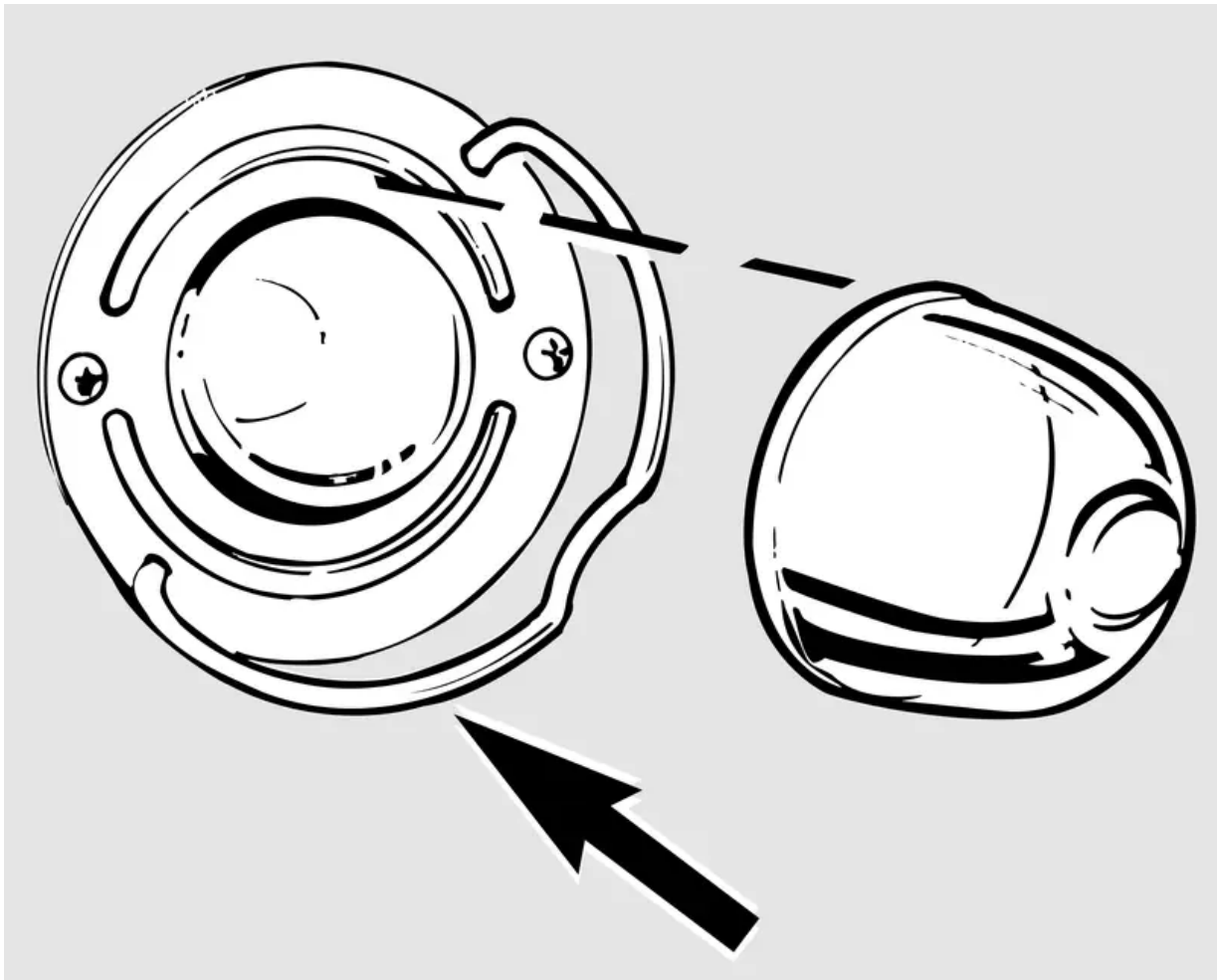

Wire cover holder.

CAUTION: Before replacing your oven light bulb, disconnect the electrical power to the range at the main fuse or circuit breaker panel.

Be sure to let the light cover and bulb cool completely.

To remove the cover:

1. Hold a hand under the cover so it doesn't fall when released. With fingers of the same hand, firmly push back the wire cover holder. Lift off the cover. *Do not remove any screws to remove the cover.*
2. Replace bulb with a 40-watt appliance bulb.

To replace the cover:

1. Place it into groove of the light receptacle. Pull wire forward to the center of the cover until it snaps into place
2. Connect electrical power to the range.

Oven Heating Elements

Do not clean the bake element or the broil element. Any soil will burn off when the elements are heated.

To clean the oven floor, gently lift the bake element. Clean with warm soapy water.

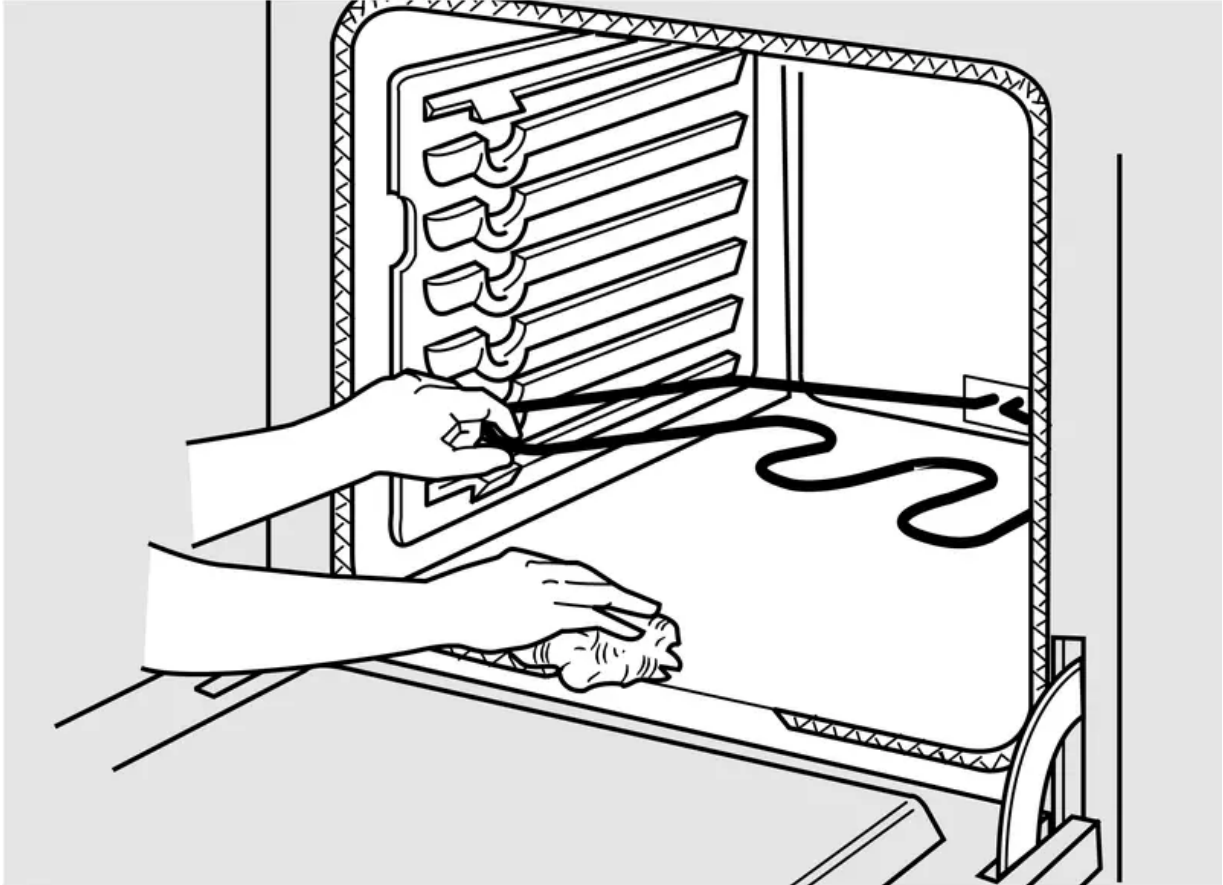

Cleaning the glass cooktop.

Control Lockout (on some models)

Begin by locking the cooktop; see the Control Lockout section.

Normal Daily Use Cleaning



Clean your cooktop after each spill.

ONLY use the recommended cleaning cream, Cerama Bryte®, on the glass cooktop. Other creams may not be as effective.

To maintain and protect the surface of your glass cooktop, follow these steps:

1. Before using the cooktop for the first time, clean it with the cooktop cleaning cream. This helps protect the top and makes clean-up easier.
2. Daily use of the cooktop cleaning cream will help keep the cooktop looking new.

3. Shake the cleaning cream well. Apply a few drops of the cream directly to the cooktop.
4. Use a paper towel or sponge to clean the entire cooktop surface.

NOTE: It is very important that you DO NOT heat the cooktop until it has been cleaned thoroughly.

Burned-On Residue

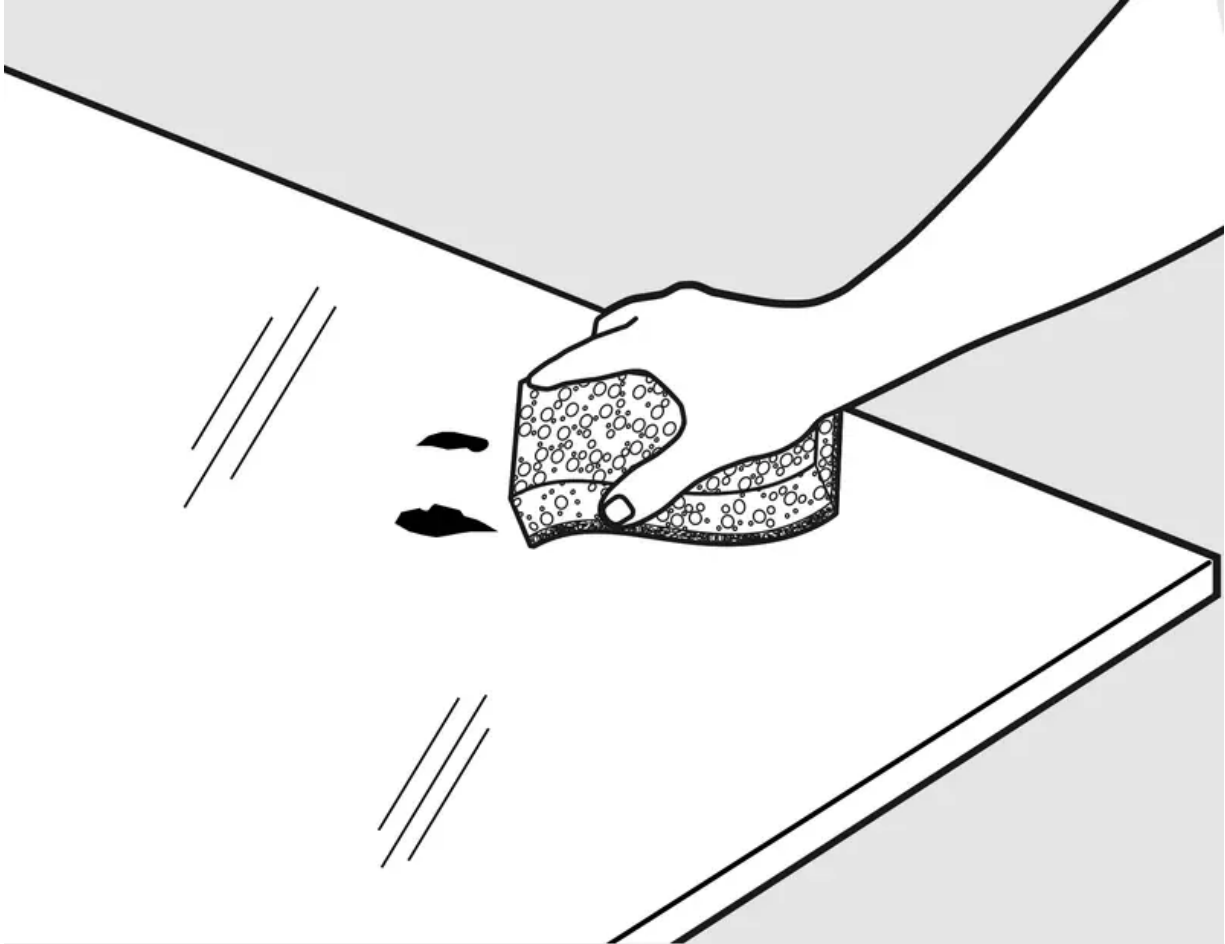

Scotch-Brite® Multi-Purpose No Scratch scrub sponge

WARNING: DAMAGE to your glass surface may occur if you use scrub pads other than BLUE Scotch-Brite® Multi-Purpose No Scratch scrub sponges by 3M.

1. Allow the cooktop to cool.
2. Spread a few drops of Cerama Bryte® to the entire burned residue area.
3. Using the scrub sponge, rub the residue area, applying pressure as needed.
4. If any residue remains, repeat the steps listed above as needed.
5. For additional protection, after all residue has been removed, polish the entire surface with Cerama Bryte® and a paper towel.

Heavy, Burned-On Residue

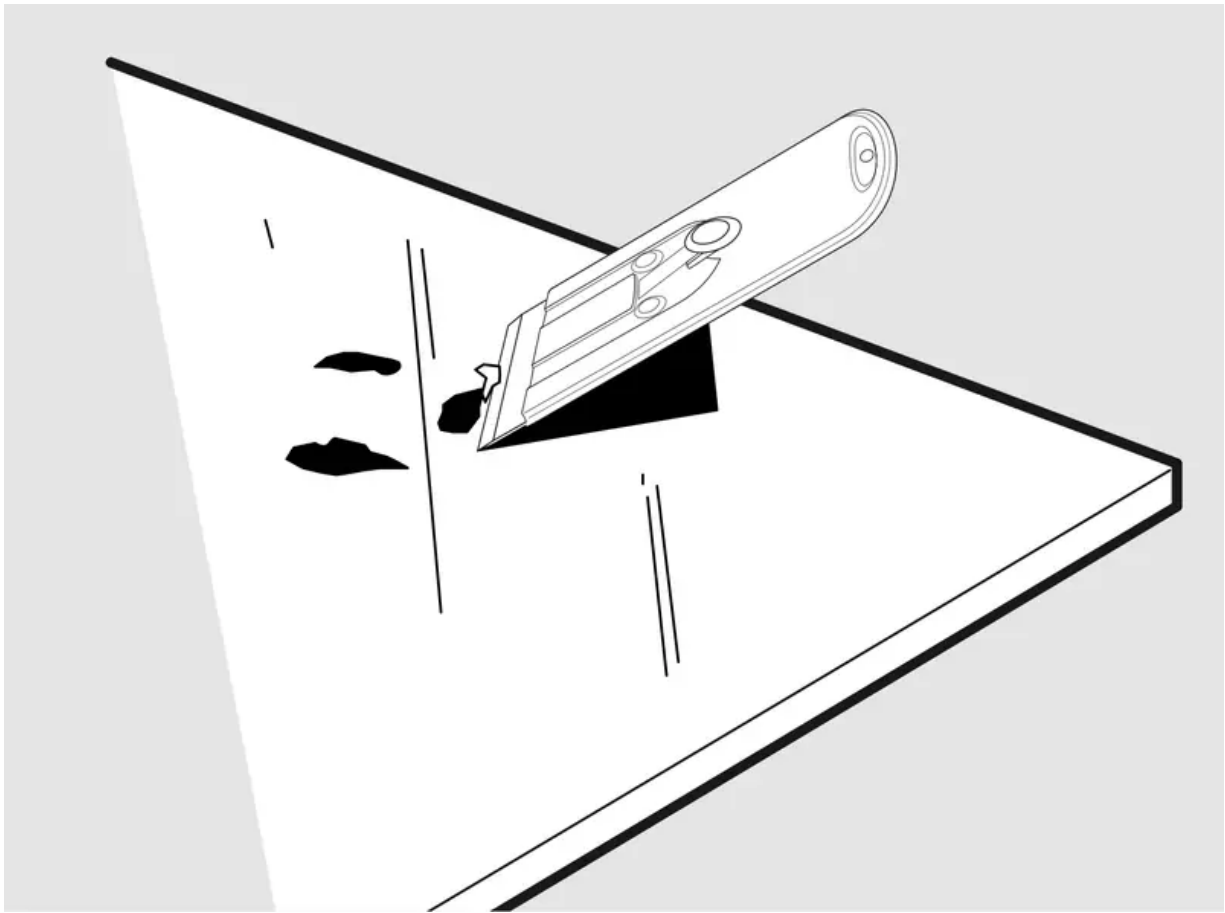

The RAZOR SCRAPER is available through our Parts Center. See instructions under “To Order Parts” section on next page.

1. Allow the cooktop to cool.
2. Spread a few drops of Cerama Bryte® to the entire burned residue area.
3. Hold the razor scraper at approximately a 45° angle against the glass surface and scrape the soil. It will be necessary to apply pressure to the razor scraper in order to remove the residue.
4. Keep a small amount of cream on the residue as you scrape.
5. After scraping with the razor scraper, use the scrub sponge to remove any remaining residue.
6. For additional protection, after all residue has been removed, polish the entire surface with Cerama Bryte® and a paper towel.

NOTE: Razor blade is packed inverted for safety reasons. Prior to use, the blade must be rotated and reinserted into slot. Do not use a dull or nicked blade.

Metal Marks and Scratches

1. Be careful not to slide pots and pans across your cooktop. It will leave metal markings on the cooktop surface. These marks are removable using the cleaning cream with a scrub sponge and/or razor scraper.

2. If pots with a thin overlay of aluminum or copper are allowed to boil dry, the overlay may leave black discoloration on the cooktop. This should be removed immediately before heating again or the discoloration may be permanent.

WARNING: Carefully check the bottom of pans for roughness that would scratch the cooktop.

Cooktop Seal

To clean the cooktop seal around the edges of the glass, lay a wet cloth on it for a few minutes, then wipe clean with nonabrasive cleaners.

Glass surface – potential for permanent damage.

Our testing shows that if you are cooking high sugar mixtures such as jelly or fudge and have a spillover, it can cause permanent damage to the glass surface unless the spillover is immediately removed.

Damage from Sugary Spills and Melted Plastic

1. Turn off all surface units. Remove hot pans.
2. Wearing an oven mitt: Use the razor scraper to move the spill to a cool area on the cooktop. Remove the spill with paper towels.
3. Any remaining spillover should be left until the surface of the cooktop has cooled.
4. Don't use the surface units again until all of the residue has been completely removed.

NOTE: If pitting or indentation in the glass surface has already occurred, the cooktop glass will have to be replaced. In this case, service will be necessary.

TROUBLESHOOTING



Problem	Possible Causes	What To Do
Surface units will not maintain a rolling boil or cooking is not fast enough	Improper cookware being used.	<ul style="list-style-type: none"> • Use pans which are flat and match the diameter of the surface unit selected.
Surface units do not work properly	A fuse in your home may be blown or the circuit breaker tripped.	<ul style="list-style-type: none"> • Replace the fuse or reset the circuit breaker.
	Cooktop controls improperly set.	<ul style="list-style-type: none"> • Check to see the correct control is set for the surface unit you are using.
Scratches (may appear as cracks) on cooktop glass surface	<p>Incorrect cleaning methods being used.</p> <p>Cookware with rough bottoms being used or coarse particles (salt or sand) were between the cookware and the surface of the cooktop.</p> <p>Cookware has been slid across the cooktop surface.</p>	<ul style="list-style-type: none"> • Scratches are not removable. Tiny scratches will become less visible in time as a result of cleaning. • To avoid scratches, use the recommended cleaning procedures. Make sure bottoms of cookware are clean before use, and use cookware with smooth bottoms.
Areas of discoloration on the cooktop	Food spillovers not cleaned before next use.	<ul style="list-style-type: none"> • See the Cleaning the glass cooktop section.
	Hot surface on a model with a white glass cooktop.	<ul style="list-style-type: none"> • This is normal. The surface may appear discolored when it is hot. This is temporary and will disappear as the glass cools.

Problem	Possible Causes	What To Do
Plastic melted to the surface	Hot cooktop came into contact with plastic placed on the hot cooktop.	<ul style="list-style-type: none"> • See the Glass surface—potential for permanent damage section in the Cleaning the glass cooktop section.
Pitting (or indentation) of the cooktop	Hot sugar mixture spilled on the cooktop.	<ul style="list-style-type: none"> • Call a qualified technician for replacement.
Frequent cycling off and on of surface units	Improper cookware being used.	<ul style="list-style-type: none"> • Use only flat cookware to minimize cycling.
Control signals after entering cooking time or delay start	You forgot to enter a bake temperature or cleaning time.	<ul style="list-style-type: none"> • Press the BAKE pad and desired temperature or the SELF CLEAN pad and desired clean time.
Food does not bake or roast properly	Oven controls improperly set.	<ul style="list-style-type: none"> • See the Using the oven section.
	Shelf position is incorrect or the shelf is not level.	<ul style="list-style-type: none"> • See the Using the oven section.
	Incorrect cookware or cookware of improper size being used.	<ul style="list-style-type: none"> • See the Using the oven section.
	Oven thermostat needs adjustment.	<ul style="list-style-type: none"> • See the Adjust the oven thermostat—Do it yourself! section.
Clock and timer do not work	Plug on range is not completely inserted in the electrical outlet.	<ul style="list-style-type: none"> • Make sure electrical plug is plugged into a live, properly grounded outlet.

Problem	Possible Causes	What To Do
	A fuse in your home may be blown or the circuit breaker tripped.	<ul style="list-style-type: none"> • Replace the fuse or reset the circuit breaker.
	Oven controls improperly set.	<ul style="list-style-type: none"> • See the Using the clock and timer section.
Oven light does not work	Light bulb is loose or defective.	<ul style="list-style-type: none"> • Tighten or replace the bulb.
	Switch operating light is broken.	<ul style="list-style-type: none"> • Call for service.
Food does not broil properly	Door not open to the broil stop position as recommended.	<ul style="list-style-type: none"> • See the Using the oven section.
	Oven controls improperly set.	<ul style="list-style-type: none"> • Make sure you press the BROIL HI/LO pad.
	Improper shelf position being used.	<ul style="list-style-type: none"> • See the Broiling Guide.
	Cookware not suited for broiling.	<ul style="list-style-type: none"> • Use the broiling pan and grid that came with your range.
	Aluminum foil used on the the broiling pan and grid has not been fitted properly and slit as recommended.	<ul style="list-style-type: none"> • See the Using the oven section.
	In some areas the power (voltage) may be low.	<ul style="list-style-type: none"> • Preheat the broil element for 10 minutes. • Broil for the longest period of time recommended in the Broiling Guide.

Problem	Possible Causes	What To Do
Oven temperature too hot or too cold	Oven thermostat needs adjustment.	<ul style="list-style-type: none"> • See the Adjust the oven thermostat—Do it yourself! section.
Oven will not work	A fuse in your home may be blown or the circuit breaker tripped.	<ul style="list-style-type: none"> • Replace the fuse or reset the circuit breaker.
	Oven controls improperly set.	<ul style="list-style-type: none"> • See the Using the oven section.
Storage drawer is crooked	Rear drawer support is on top of the guide rail.	<ul style="list-style-type: none"> • Reposition the drawer. See the Storage Drawer Removal instructions in the Care and cleaning of your range section.
Storage drawer won't close	Power cord may be obstructing drawer in the lower back of the range.	<ul style="list-style-type: none"> • Reposition the drawer and power cord. See the Storage Drawer Removal instructions in the Care and cleaning of your range section.
	Rear drawer support is on top of the guide rail.	<ul style="list-style-type: none"> • Reposition the drawer. See the Storage Drawer Removal instructions in the Care and cleaning of your range section.
Oven will not self-clean	The oven temperature is too high to set a self-clean operation.	<ul style="list-style-type: none"> • Allow the oven to cool to room temperature and reset the controls.
	Oven controls improperly set.	<ul style="list-style-type: none"> • See the Using the self-cleaning oven section.
“Crackling” or “popping” sound	This is the sound of the metal heating and cooling	<ul style="list-style-type: none"> • This is normal.

Problem	Possible Causes	What To Do
	during both the cooking and cleaning functions.	
Excessive smoking during a clean cycle	Excessive soil.	<ul style="list-style-type: none"> • Press the CLEAR/OFF pad. Open the windows to rid the room of smoke. Wait until the LOCKED DOOR light goes off. Wipe up the excess soil and reset the clean cycle.
Oven door will not open after a clean cycle	Oven too hot.	<ul style="list-style-type: none"> • Allow the oven to cool below locking temperature.
Oven not clean after a clean cycle	Oven controls not properly set.	<ul style="list-style-type: none"> • See the Using the self-cleaning oven section.
	Oven was heavily soiled.	<ul style="list-style-type: none"> • Clean up heavy spillovers before starting the clean cycle. Heavily soiled ovens may need to self-clean again or for a longer period of time.
“LOCK DOOR” flashes in the display	The self-clean cycle has been selected but the door is not closed.	<ul style="list-style-type: none"> • Close the oven door.
LOCKED DOOR light is on when you want to cook	The oven door is locked because the temperature inside the oven has not dropped below the locking temperature.	<ul style="list-style-type: none"> • Press the CLEAR/OFF pad. Allow the oven to cool.
“F— and a number or letter” flash in the display	You have a function error code.	<ul style="list-style-type: none"> • Press the CLEAR/OFF pad. Put the oven back into operation.

Problem	Possible Causes	What To Do
	If the function code repeats.	<ul style="list-style-type: none"> • Disconnect all power to the range for at least 30 seconds and then reconnect power. If the function error code repeats, call for service.
Display goes blank	A fuse in your home may be blown or the circuit breaker tripped.	<ul style="list-style-type: none"> • Replace the fuse or reset the circuit breaker.
	The clock is in the black-out mode.	<ul style="list-style-type: none"> • See the Special features of your oven control section.
Display flashes	Power failure.	<ul style="list-style-type: none"> • Reset the clock.
Unable to get the display to show “SF”	Oven control pads were not pressed properly.	<ul style="list-style-type: none"> • The BAKE and BROIL HI/LO pads must be pressed at the same time and held for 3 seconds.
Power outage, clock flashes	Power outage or surge.	<ul style="list-style-type: none"> • Reset the clock. If the oven was in use, you must reset it by pressing the CLEAR/OFF pad, setting the clock and resetting any cooking function.
“Burning” or “oily” odor emitting from the vent	This is normal in a new oven and will disappear in time.	<ul style="list-style-type: none"> • To speed the process, set a self-clean cycle for a minimum of 3 hours. See the Using the self-cleaning oven section.
Strong odor	An odor from the insulation around the inside of the oven is normal for the first few times the oven is used.	<ul style="list-style-type: none"> • This is temporary.

Warning

This content is compiled from multiple sources and is provided for reference purposes only. It may not be complete or fully applicable to all situations. If you are unable to resolve your issue, please contact the product manufacturer or an authorized service provider for official support.

Document generated by [ManualsFile](#)