

What's included

Make sure all the parts are included in the product package. If you have a problem with the washing machine or the parts, contact a local Samsung customer centre or the retailer.

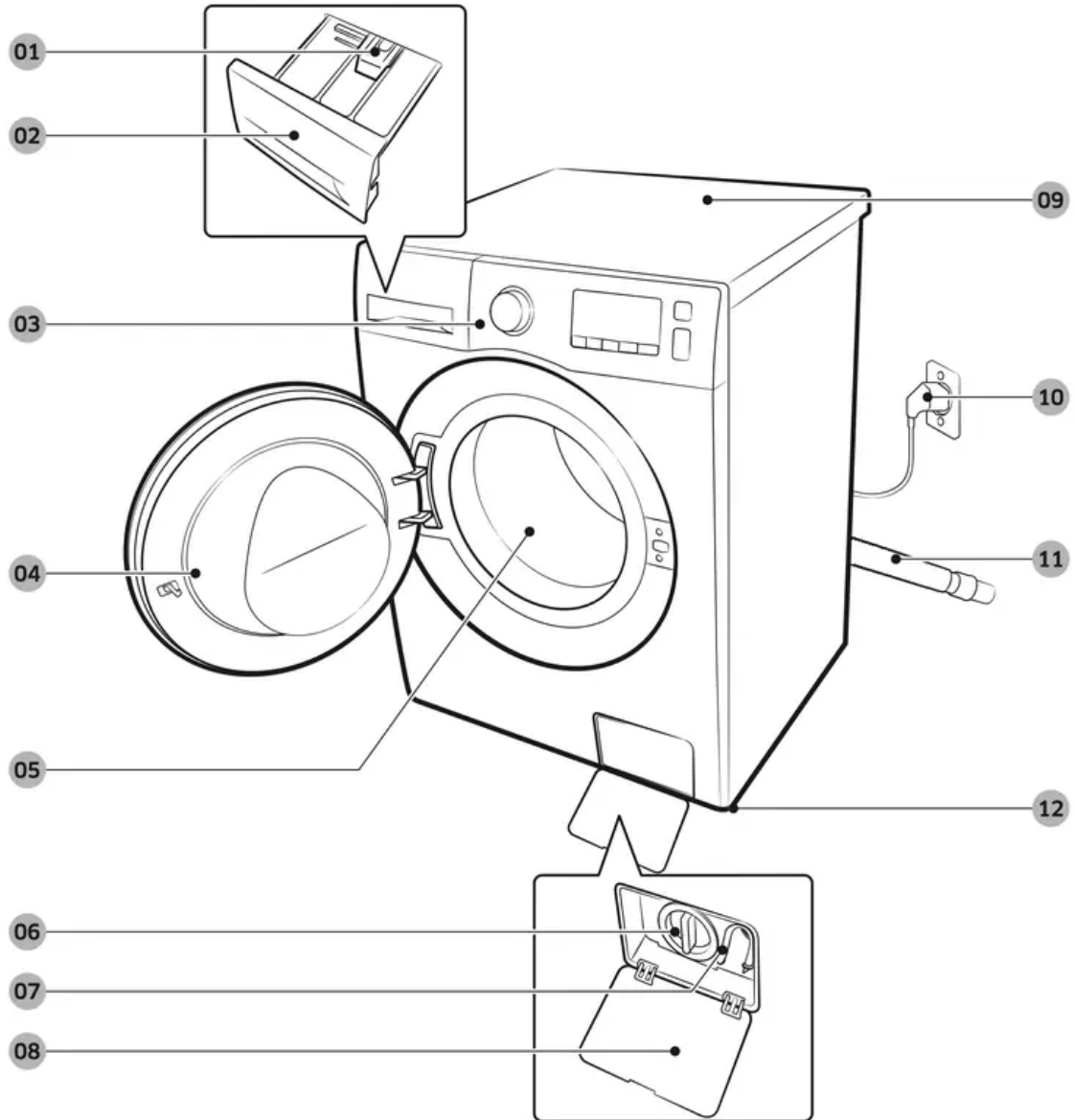

1. Release lever
2. Detergent drawer
3. Control panel
4. Door
5. Drum
6. Lint filter
7. Emergency drain tube

- 8. Filter cover
- 9. Worktop
- 10. Power plug
- 11. Drain hose
- 12. Levelling feet



Spanner

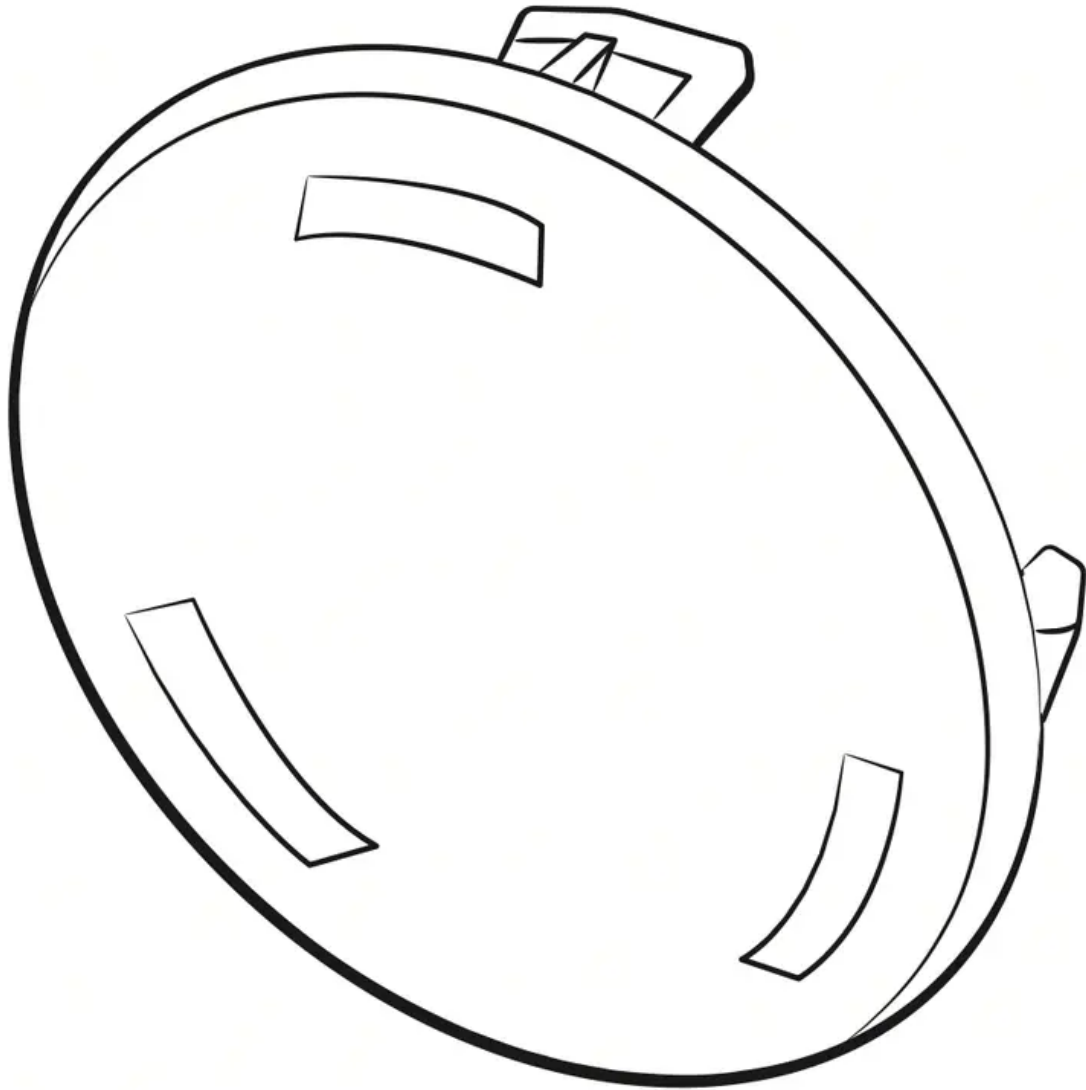

Bolt caps

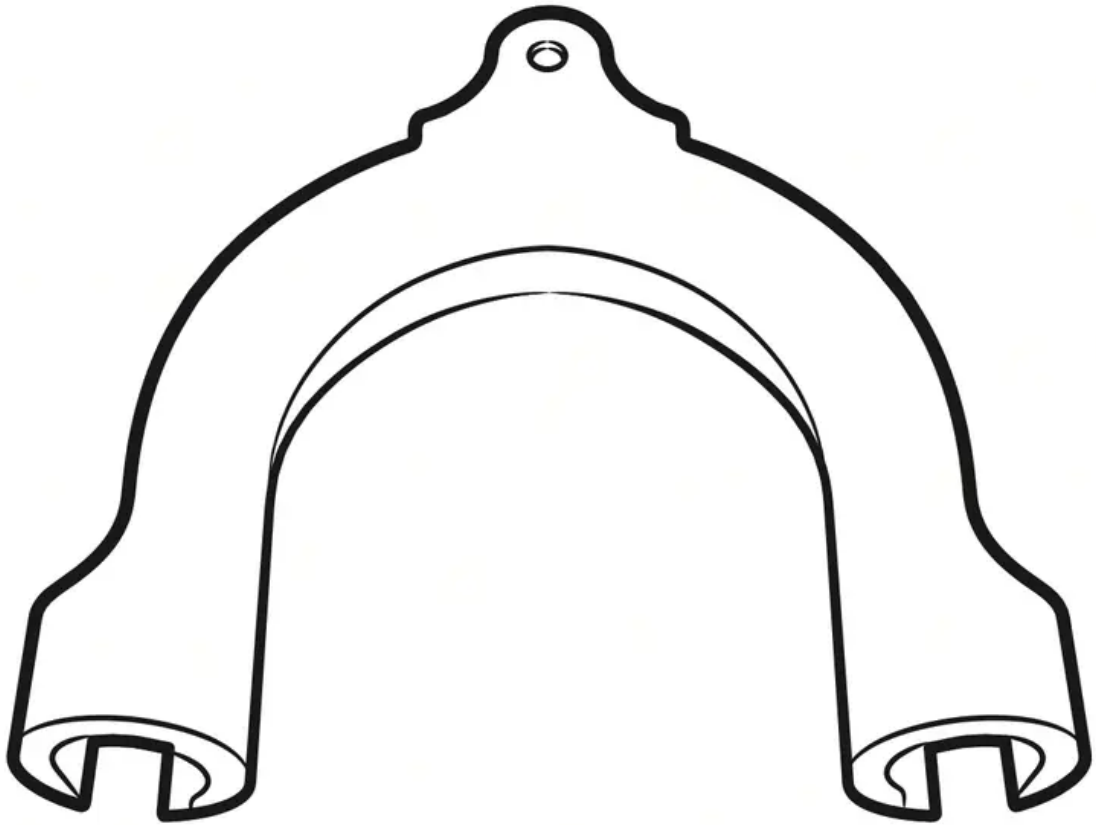

Hose guide

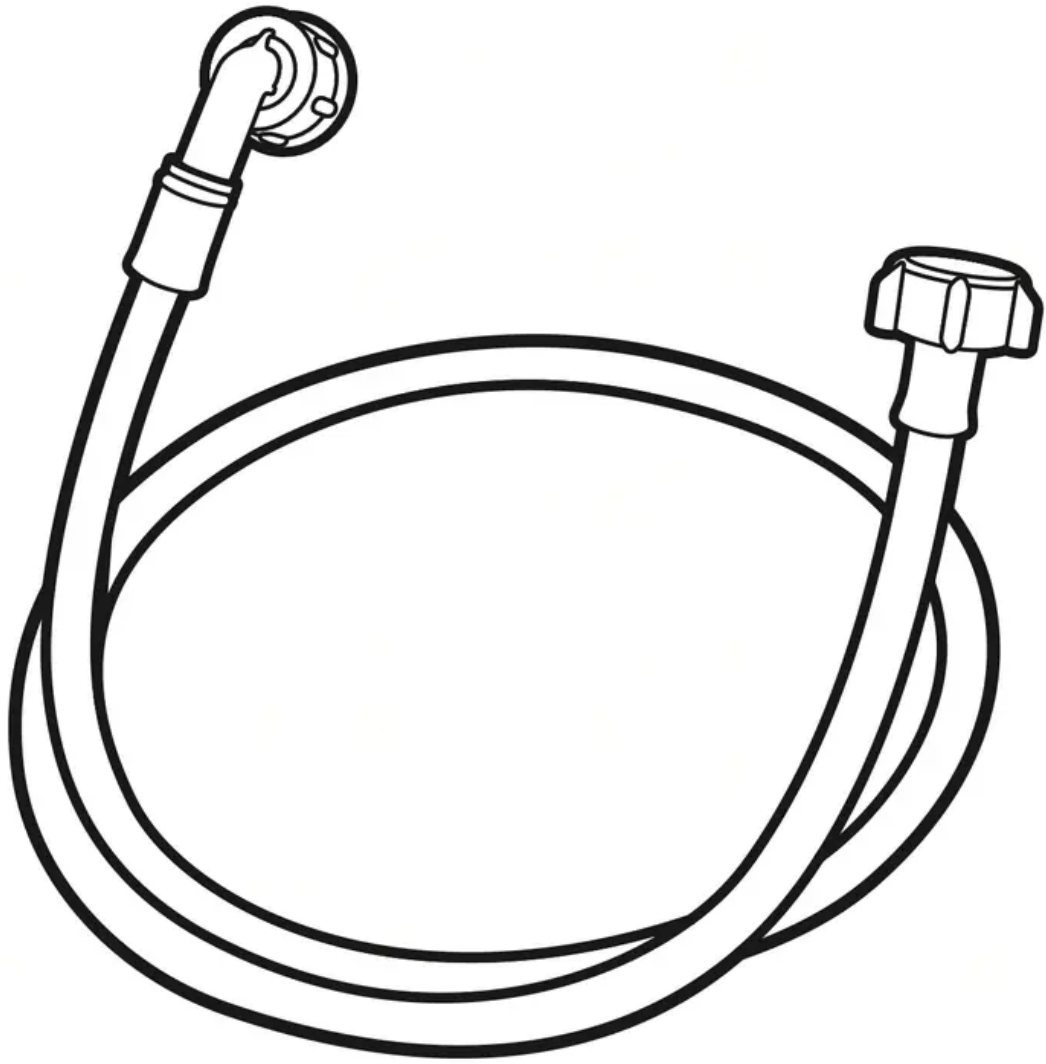

Cold water hose

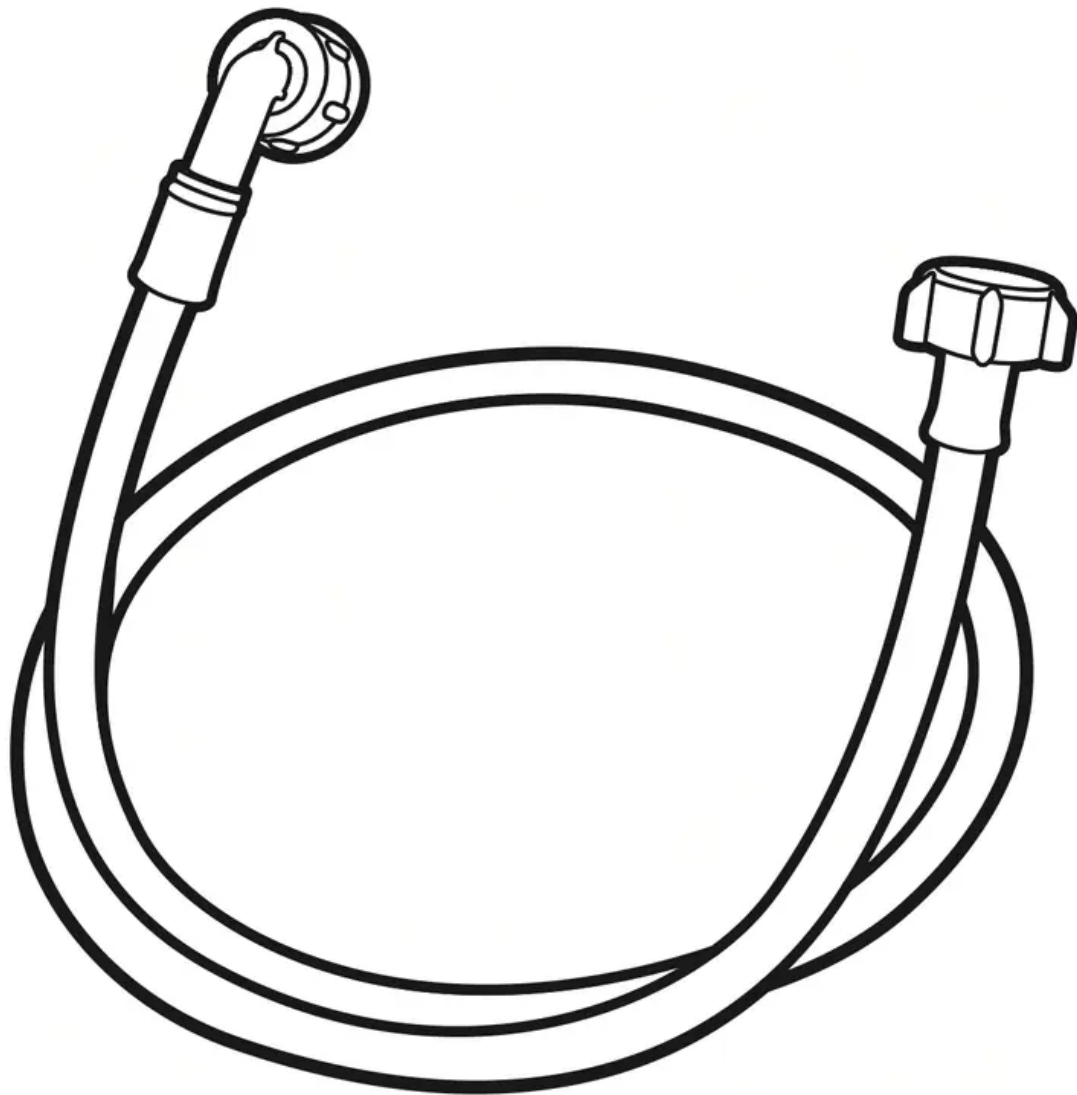

Hot water hose

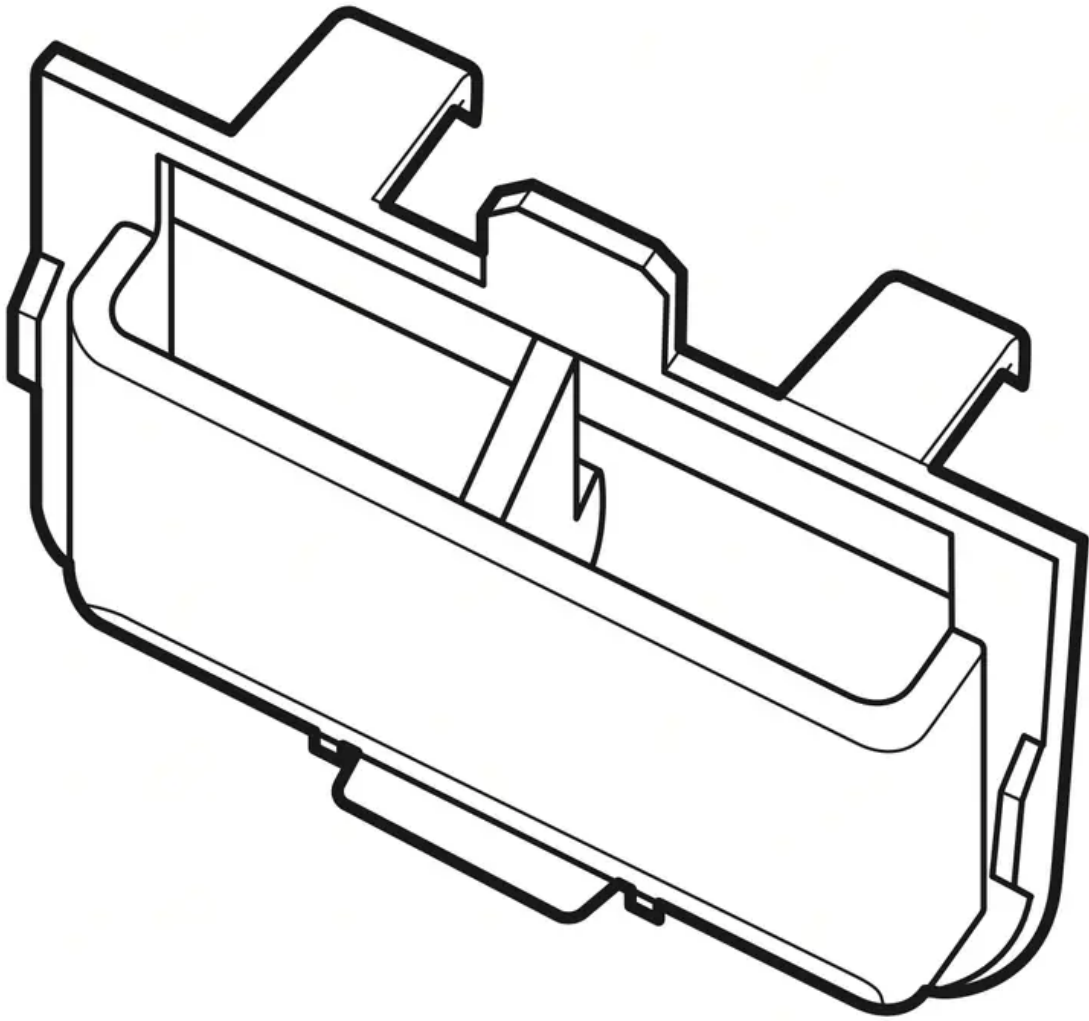

Liquid detergent container

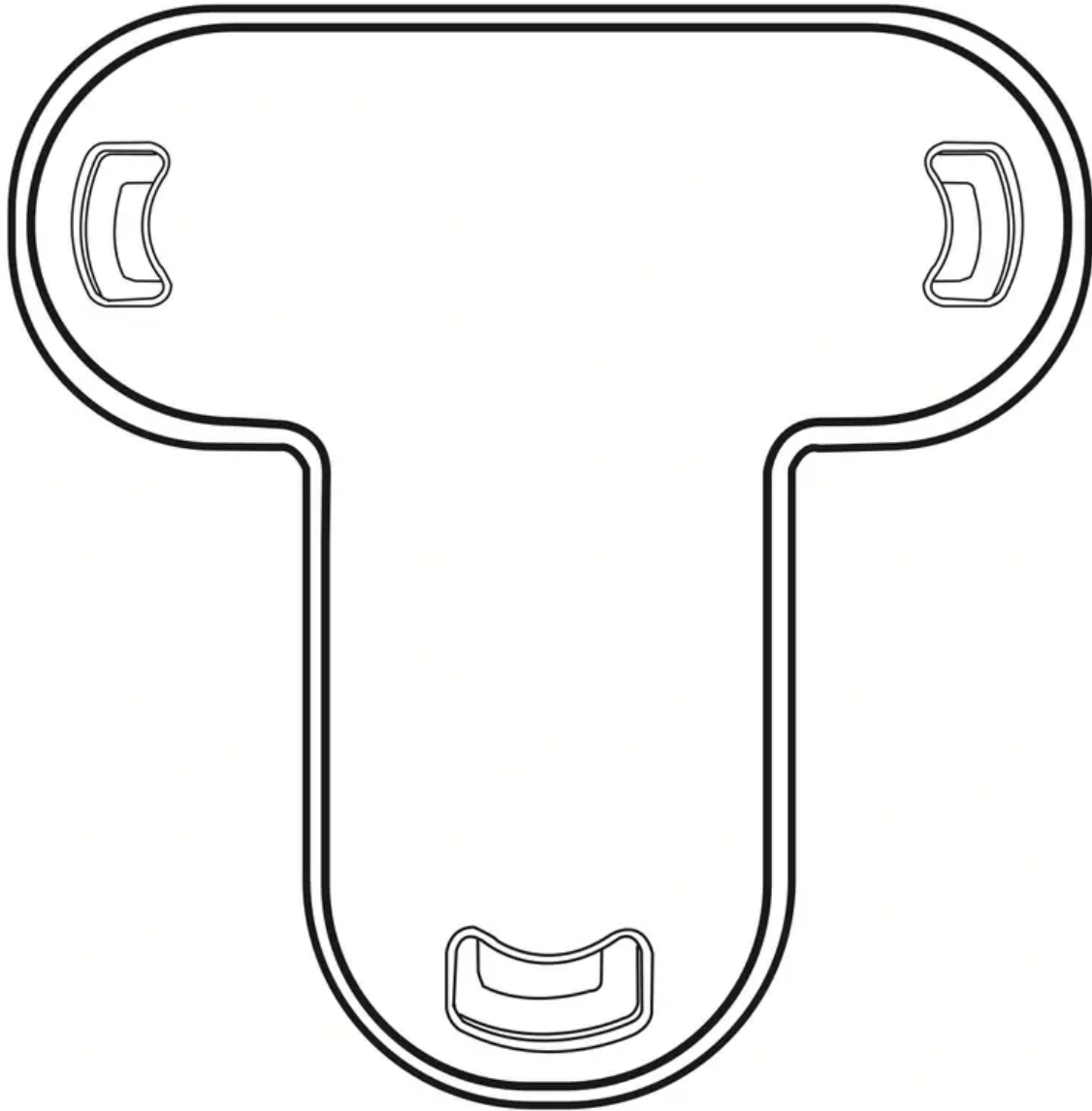

Cap fixer

NOTE



- Spanner: For removing the shipping bolts and levelling the washing machine.
- Bolt caps : For covering the holes after removing the shipping bolts. The provided number of bolt caps (3 to 6) depends on the model.
- Hose guide: For hanging the drain hose in the drainpipe or wash-basin.
- Cold/Hot water hose: For supplying water to the washing machine. (Hot water hoses is for applicable models only.)
- Liquid detergent guide: Insert it in the detergent compartment to use liquid detergent. (Applicable models only)

Before you start

Initial settings

Run Calibration (recommended)

Calibration ensures accurate weight detection by the washing machine. Make sure the drum is empty before running Calibration.

1. Power off, and then power on the washing machine.
2. Hold down  **Temp.** and  **Delay End** simultaneously for 3 seconds to enter Calibration mode. The “CB” message appears.
3. Press  **Start/Pause** to run the Calibration cycle.
4. The drum will rotate clockwise and counter-clockwise for about 3 minutes.
5. When the cycle is complete, “0” appears on the display and the washing machine will turn off automatically.
6. The washing machine is now ready for use.

Laundry guidelines

STEP 1: Sort

Sort the laundry according to these criteria:

- Care Label: Sort the laundry into cottons, mixed fibres, synthetics, silks, wools, and rayon.
- Colour: Separate whites from colours.
- Size: Mixing different-sized items together in the drum improves the washing performance.
- Sensitivity: Wash delicate items separately using an Easy Iron option for pure, new woollen items, curtains, and silk items. Check the labels on the items.

NOTE: Make sure to check the care label on the clothing, and sort them accordingly before starting the wash.

STEP 2: Empty pockets

Empty all the pockets of your laundry items

- Metal objects such as coins, pins, and buckles on clothing may damage other laundry items as well as the drum.

Turn clothing with buttons and embroideries inside out

- If pants or jacket zippers are open while washing, the drum may be damaged. Zippers should be closed and fixed with a string.
- Clothing with long strings may become entangled with other clothes. Make sure to tie the strings before starting the wash.

STEP 3: Use a laundry net

- Brassieres (water washable) must be placed in a laundry net. Metal parts of the brassieres may break through and tear other laundry items.
- Small, light clothing such as socks, gloves, stockings, and handkerchiefs may become caught around the door. Place them inside a fine laundry net.
- Do not wash the laundry net by itself without other laundry. This may cause abnormal vibrations that could move the washing machine and result in injury.

STEP 4: Prewash (if necessary)

Select the Prewash option for the selected cycle if the laundry is heavily soiled. Do not use the Prewash option when detergent is manually added into the drum.

STEP 5: Determine the load capacity

Do not overload the washing machine. Overloading may cause the washing machine to not wash properly. For the load capacity for the type of clothing, see page 40.

NOTE: When washing bedding or bedding covers, the wash time may be lengthened or the spin efficiency may be reduced. For bedding or bedding covers, the recommended maximum spin cycle speed is 800 rpm, and the load capacity is 2.0 kg or less.

CAUTION

- Unbalanced laundry may reduce the spinning performance.
- Make sure the laundry is fully inserted in the drum and not caught in the door.
- Do not slam the door. Close the door gently. Otherwise, the door may not be closed properly.

STEP 6: Apply a proper detergent type

The type of detergent depends on the type of fabric (cotton, synthetic, delicate items, wool), colour, wash temperature, and degree of soiling. Always use “low suds” laundry detergent, which is designed for automatic washing machines.

NOTE

- Follow the detergent manufacturer’s recommendations based on the weight of the laundry, the degree of soiling, and the hardness of the water in your local area. If you are not sure about the water hardness, contact a local water authority.

- Do not use detergent that tends to be hardened or solidified. This detergent may remain after the rinse cycle, blocking the drain outlet.

CAUTION: When washing wool using the WOOL/DELICATES cycle, use only a neutral liquid detergent. If used with the WOOL/DELICATES cycle, powder detergent may remain on the laundry and discolour the laundry.

Laundry capsules

To get the best results from using laundry capsules, please follow these instructions.

1. Put the capsule in the bottom of the empty drum towards the rear.

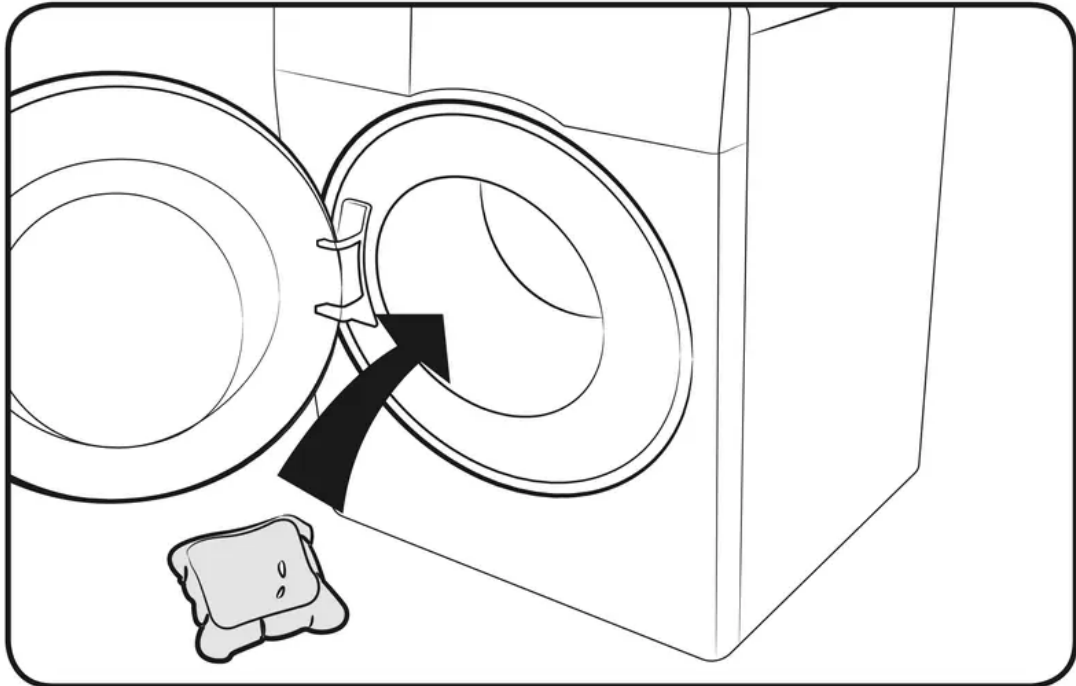

2. Put the laundry in the drum on top of the capsule.

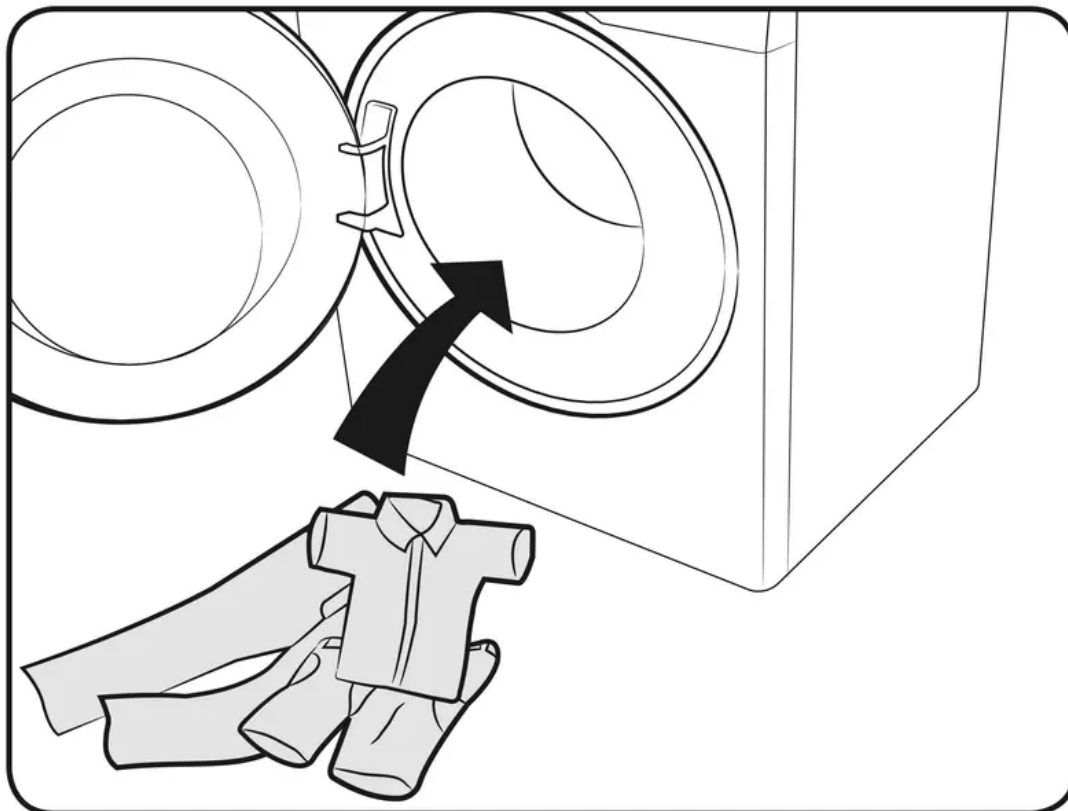

CAUTION: For cycles using cold water or cycles that complete in less than one hour, the capsule may not dissolve completely.

Detergent recommendation

The recommendations apply to the temperature ranges given in the cycle chart.

●	Recommended	▲	Liquid detergent only
–	Not recommended	△	Powder detergent only

Cycle	Detergent		
	Universal	Delicates and woollens	Specialist
ECO 40-60	●	–	–
COTTON	●	–	–
SYNTHETICS	●	–	–
INTENSE COLD	●	–	–
HYGIENE STEAM	●	–	–
DRUM CLEAN	–	–	–
15' QUICK WASH	●	–	–
MIXED LOAD	●	–	–
WOOL/DELICATES	–	▲	▲
WASH+DRY	●	–	–

Detergent drawer guidelines

The washing machine provides a three-compartment dispenser: the left compartment for the main wash, the centre compartment for fabric softeners, and the right compartment for the preliminary wash.



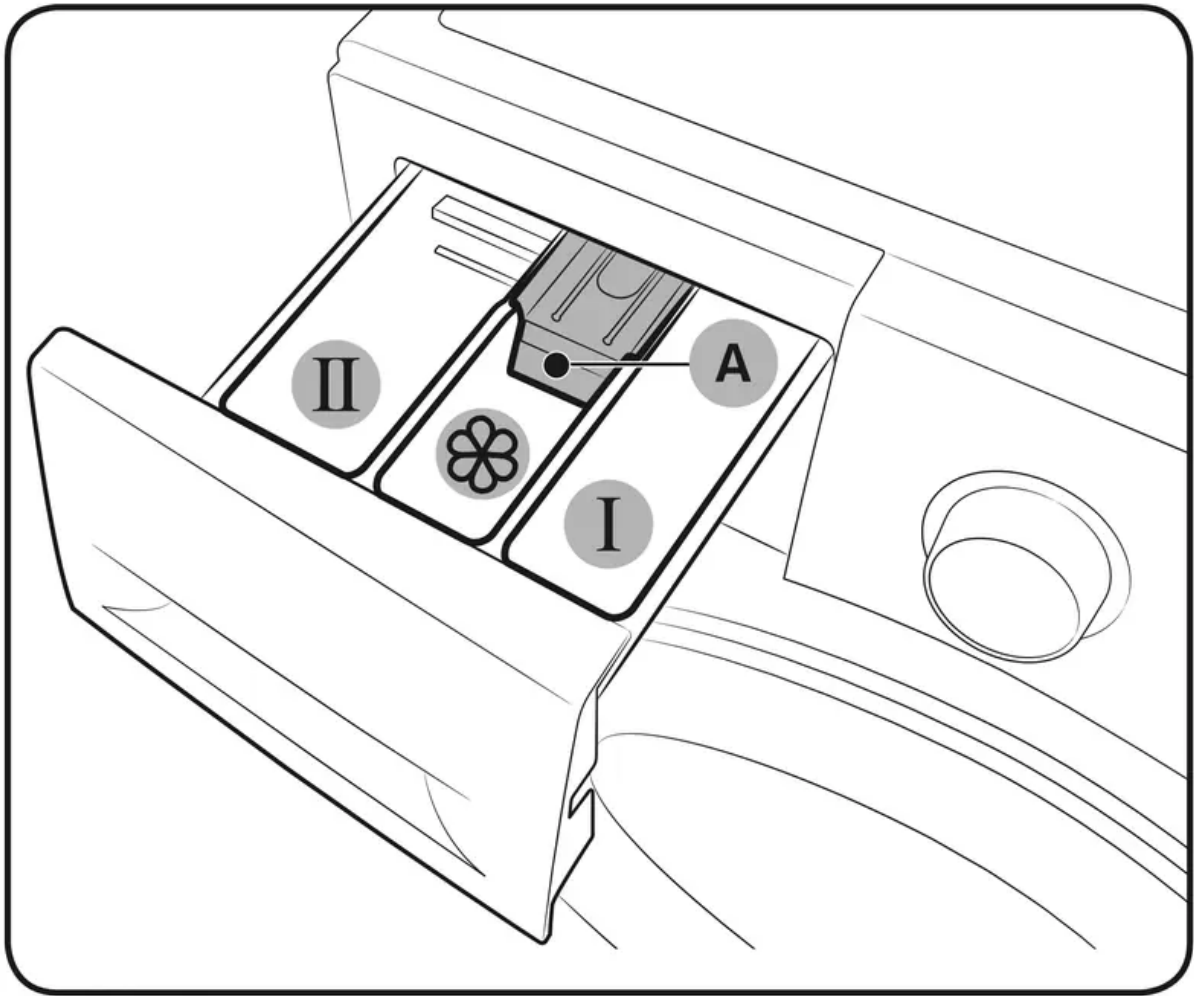

1. **I** **Prewash compartment:** Apply prewash detergent.
2. **II** **Main-wash compartment:** Apply main-wash detergent, water softener, soaking detergent, bleach, and/or stain removers.
3.  **Softener compartment:** Apply additives such as fabric softener. Do not exceed the max line (A).

CAUTION:

- Do not open the detergent drawer while the washing machine is operating.
- Do not use the following types of detergent:
 - Tablet or capsule types
 - Ball or net types
- To prevent the compartment clogging, concentrated or highly-enriched agents (fabric softener or detergent) must be diluted with water before being applied.

- When Delay End is selected, do not apply detergent directly into the drum. Otherwise, this may discolour the laundry. Use the detergent drawer when Delay End is selected.
- Do not use any cleaning agents for cleaning the drum. Chemical residue in the drum deteriorates the washing performance.

To apply washing agents to the detergent drawer

1. Slide open the detergent drawer.

2.

Apply laundry detergent to the  main-wash compartment as instructed or recommended by the manufacturer. To use liquid detergent, see page 36.

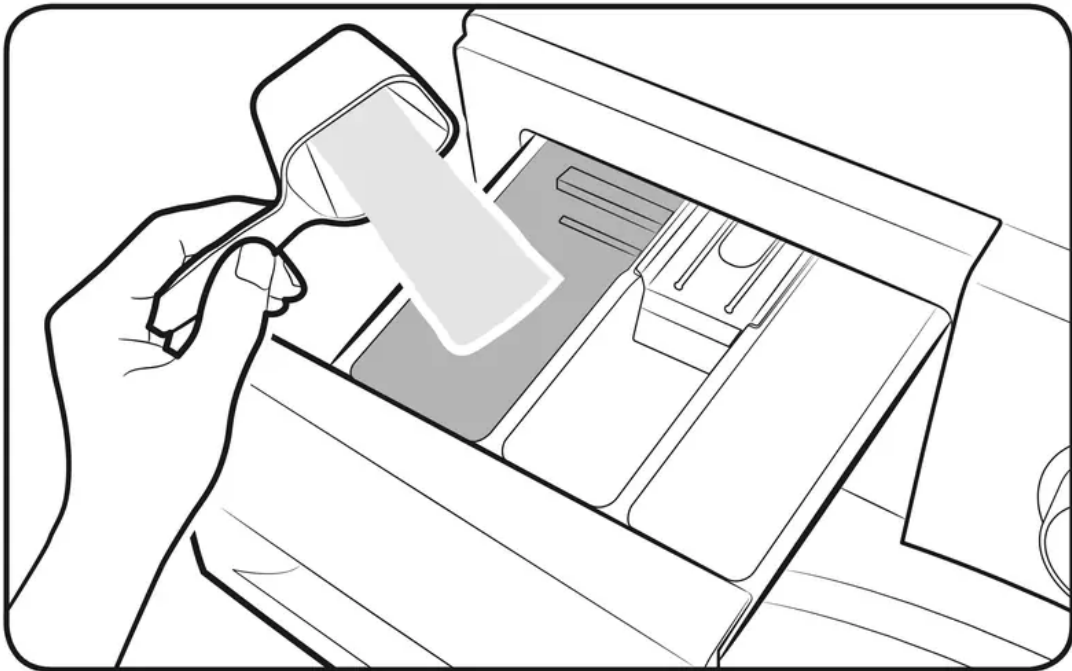

3.



Apply fabric softener to the softener compartment. Do not exceed the max line (A).

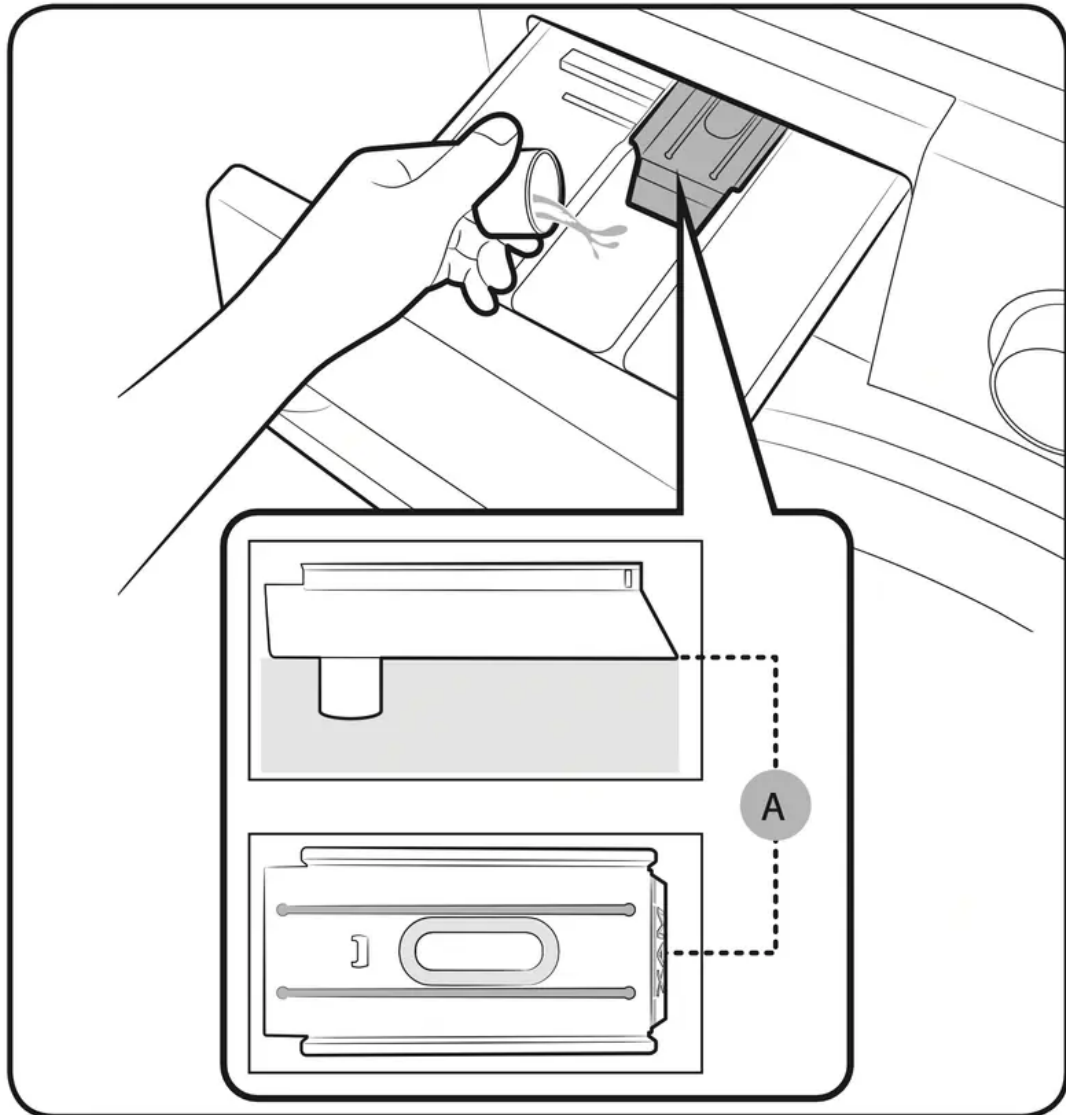

4.



If you want to prewash, apply prewash detergent to the prewash compartment as instructed or recommended by the manufacturer.

5. Close the detergent drawer.

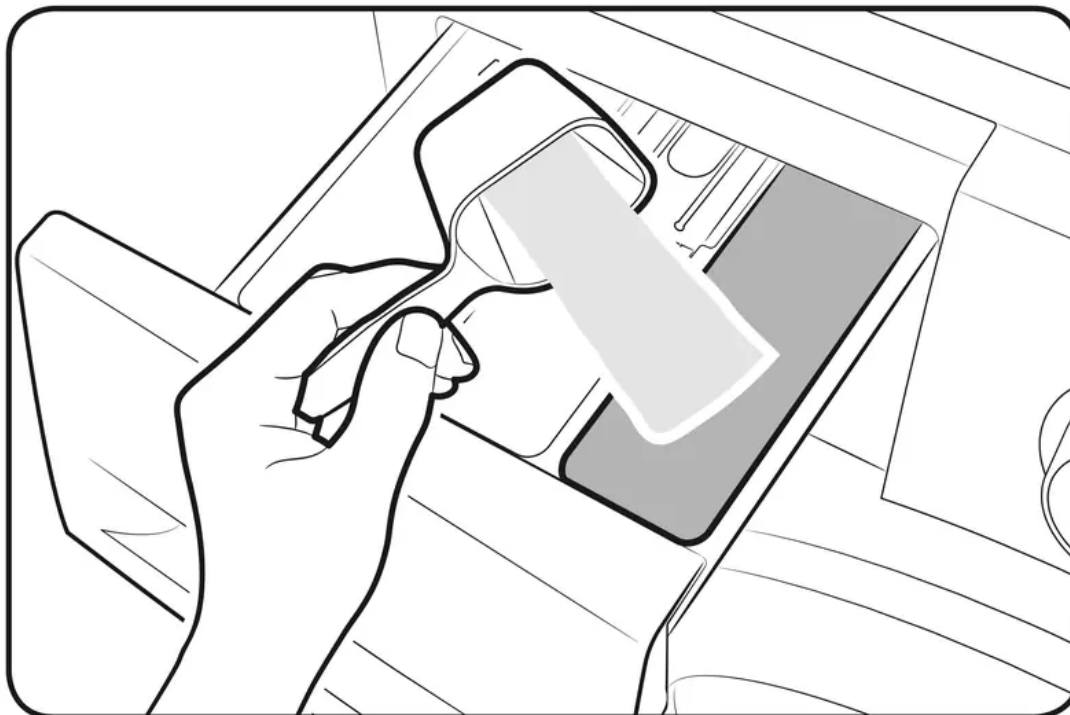

CAUTION

- Do not apply powder detergent to the liquid container.
- Concentrated fabric softener must be diluted with water before applied.

• Do not apply main-wash detergent to the  softener compartment.

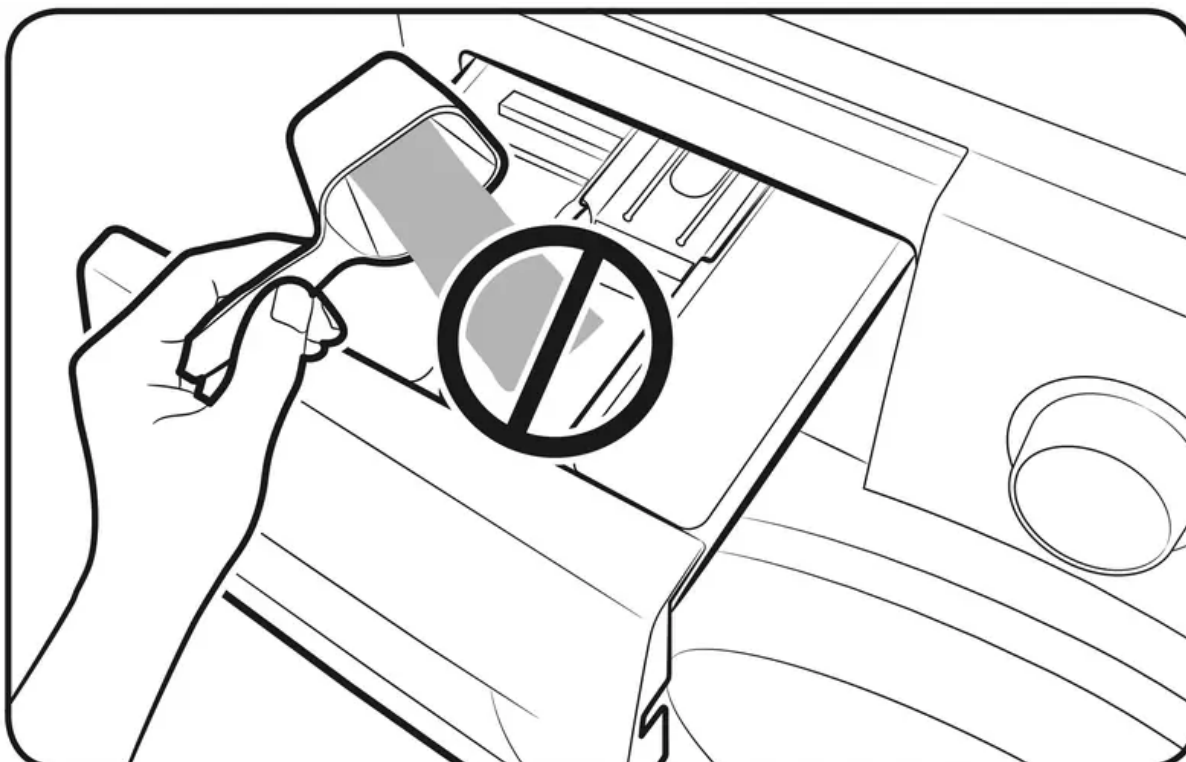

To use liquid detergent (applicable models only)

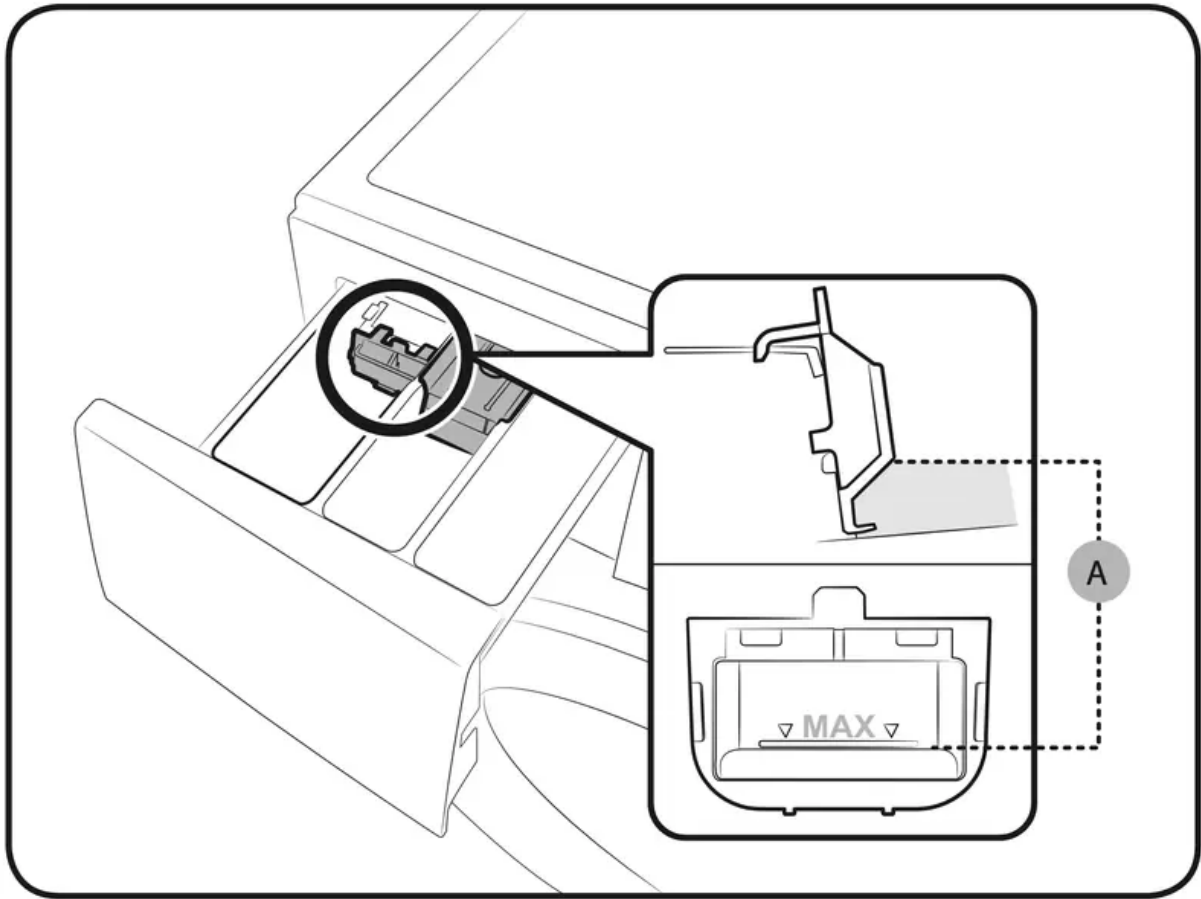

II

First insert the provided liquid container in the main-wash compartment. Then, apply liquid detergent to the container below the marked max line (A).

CAUTION

- Do not exceed the max line that is marked inside the container.
- Turn up the liquid container if using powder detergent.

When using liquid detergent



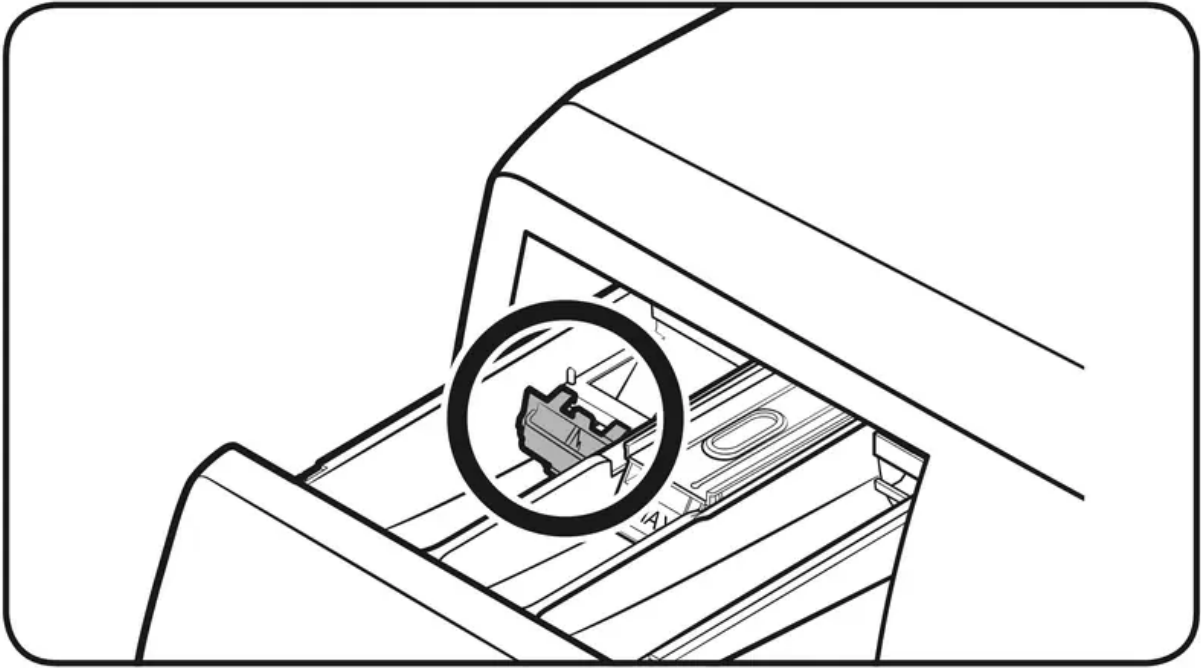

When using powder detergent

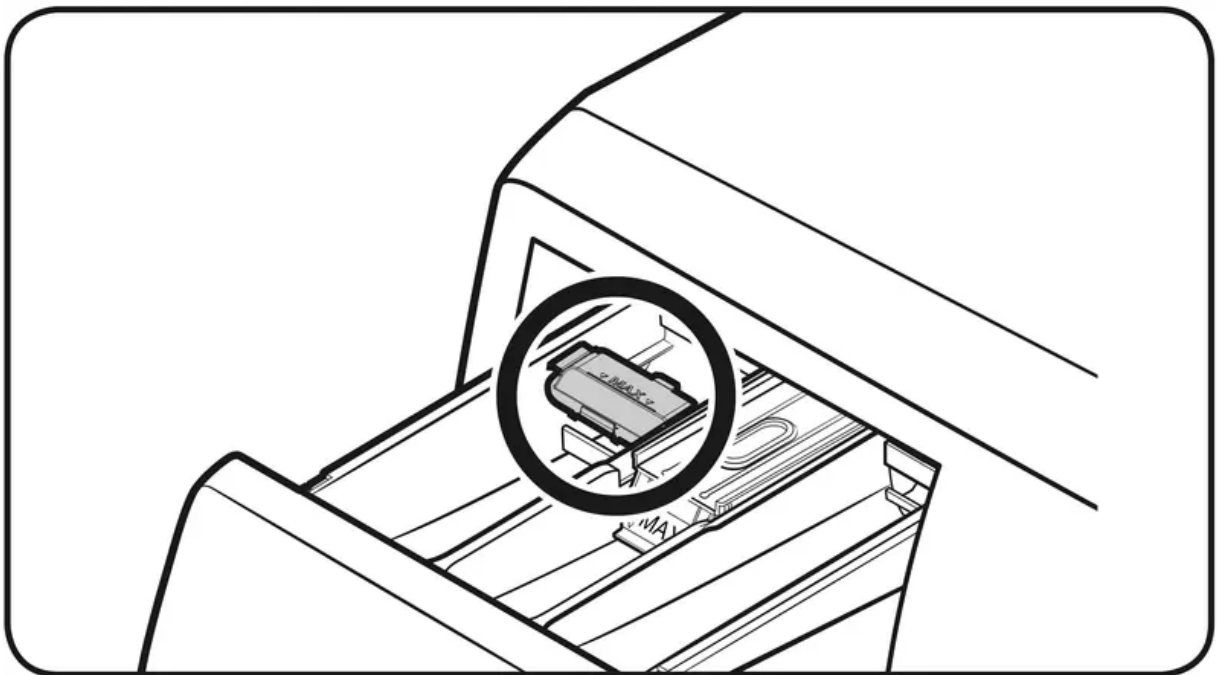

Operations

Control panel

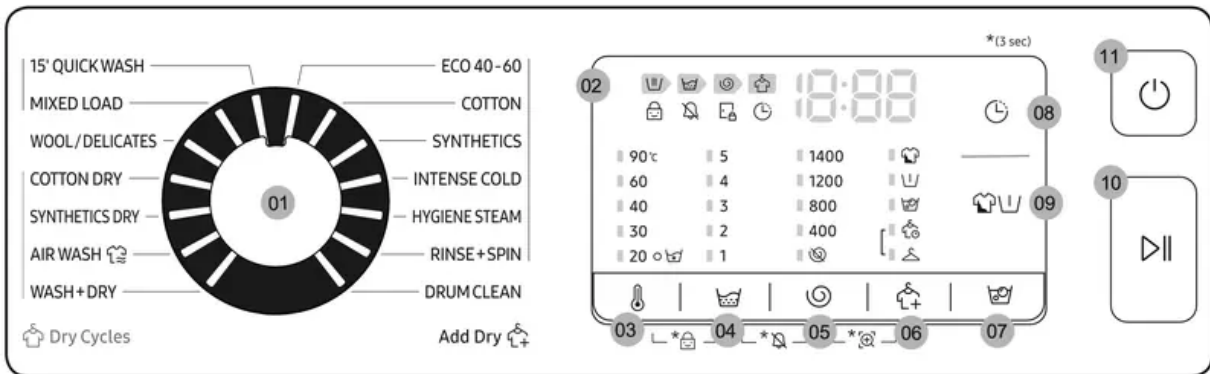

01 Cycle Selector	Turn the dial to select a cycle.
02 Display	The display shows current cycle information and estimated time remaining, or an information code when a problem occurs.
03 🌡 Temp.	Press to change the water temperature for the selected cycle.
04 🧺 Rinse	Press to change the rinse count for the current cycle. You can set the rinse count to a max of 5, depending on the cycle.
05 🌀 Spin	<p>Press to change the spinning speed for the current cycle.</p> <ul style="list-style-type: none"> • Rinse Hold (No indicator): The final rinse cycle is suspended so that the laundry remains in the water. To unload the laundry, run a drain or spin cycle. • No Spin 🌀: The drum does not spin after the final drain cycle. • Spin Only 🌀: To run the Spin Only cycle, press Spin for 3 seconds. When the cycle time and spinning speed appear, press Spin repeatedly until a desired spinning speed is selected. Then, press Start/Pause to start the cycle. The spinning time depends on the selected cycle.
06 🧺 Dry Option	Press this button to select proper drying option.
07 🧺 Bubble Soak	Press to activate/deactivate the Bubble Soak function. This function helps remove a wide variety of stubborn stains.

08 Delay End	Delay End lets you set the end time of the current cycle. Based on your settings, the start time of the cycle will be determined by the machine's internal logic. For example, this setting is useful for programming your machine to finish a wash at the time you normally return home from work. <ul style="list-style-type: none"> Press to choose a preset unit of hours.
09 Options	Press to select the options. Availability of the options depends on the cycle.
10 Start/Pause	Press to start or stop operation.
11 Power	Press to turn on/off the washing machine.

For more information on the options, see the Special features section.

*(3 sec) : Press and hold for 3 seconds.

Simple steps to start

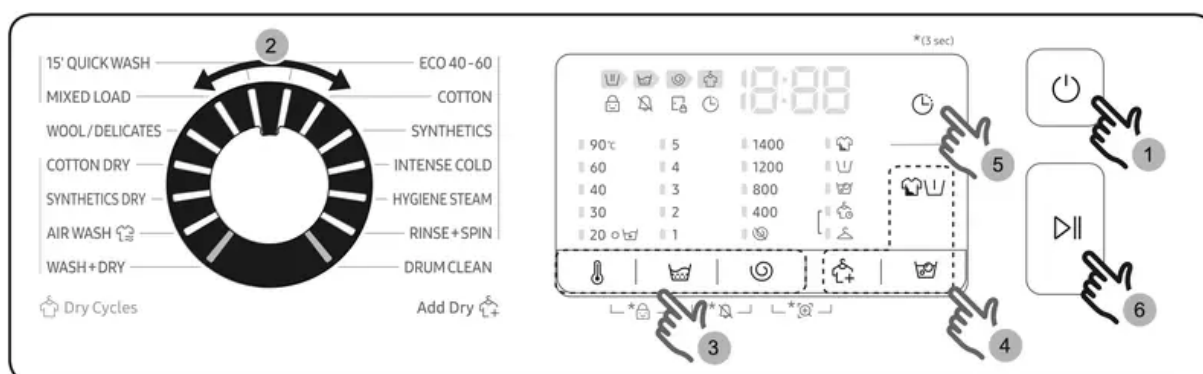

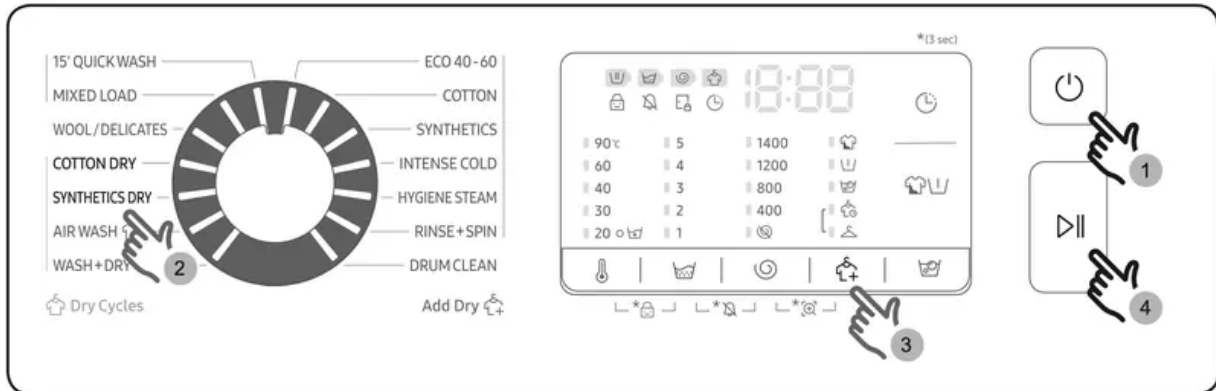

1. Press **Power** to turn on the washing machine.
2. Turn the **Cycle Selector** to select a cycle.
3. Change the cycle settings (**Temp.**, **Rinse** and **Spin**) as necessary.
4. Press **Options**, **Bubble Soak** or **Dry Option** to add desired options. Available options differ depending on the selected cycle.
5. The machine provides one easy to access buttons for **Delay End** for your convenience.
If you want to use the option, press the corresponding button.
6. Press **Start/Pause**.

Drying Only



You can dry your clothes directly or dry the washed clothes according to the following procedures.

1.  Press **Power** button to turn on the washing machine.
2. Turn the Cycle Selector to select the appropriate drying cycle.
3.  Press **Dry Option** button to select the appropriate drying mode.
4.  Press **Start/Pause** button to start dry.

To change the cycle during operation

1. Press **Start/Pause** to stop operation.
2. Select a different cycle.
3. Press **Start/Pause** again to start the new cycle.

Cycle overview

Standard cycles

Cycle	Description & Max load (kg)	WD9*TA****	WD8*TA****	WD7*TA****
ECO 40-60	<ul style="list-style-type: none"> For cleaning normally soiled cotton items which are declared to be washable at 40 °C or 60 °C, together in the same cycle. This cycle is used to assess the compliance with the EU Ecodesign legislation. This cycle is set as a default. 	Max	Max	Max
COTTON	<ul style="list-style-type: none"> For cottons, bed linens, table linens, underwear, towels, or shirts. The washing time and the rinse count are automatically adjusted according to the load. For cleaning lightly soiled cotton items at a nominal temperature of 20 °C. 	Max	Max	Max
SYNTHETICS	<ul style="list-style-type: none"> For fabrics that are made of polyester(diolen, trevira), polyamide (perlon, nylon), or the like. 	4.0	4.0	3.5
INTENSE COLD	<ul style="list-style-type: none"> Low temperature ecobubble cycle helps reduce power consumption. 	4.0	4.0	3.5
HYGIENE STEAM	<ul style="list-style-type: none"> Cotton and linen fabric which have been in direct contact with the skin, such as underwear. For optimum hygiene results select a temperature of 60 °C or above. Steam cycles feature allergy care and bacteria elimination (sterilize). 	4.0	4.0	3.5
RINSE+SPIN	<ul style="list-style-type: none"> Featuring an additional rinse process after applying fabric softener to the laundry. 	Max	Max	Max

Cycle	Description & Max load (kg)	WD9*TA****	WD8*TA****	WD7*TA****
DRUM CLEAN	<ul style="list-style-type: none"> Cleans the drum by removing dirt and bacteria from it. Perform once every 40 washes with no detergent or bleach applied. It notifies automatically after every 40 washes. Make sure the drum is empty. Do not use any cleaning agents for cleaning the drum. 	-	-	-
15' QUICK WASH	<ul style="list-style-type: none"> For lightly soiled items in less than 2.0 kg that you want to wash quickly. Use less than 20 g of detergent. Using more than 20 g of detergent may leave detergent residue. For liquid detergent, use a max of 20 ml of liquid detergent. 	2.0	2.0	2.0
MIXED LOAD	<ul style="list-style-type: none"> For mixed load consisting of cotton and synthetic. 	4.0	4.0	3.5
WOOL/ DELICATES	<ul style="list-style-type: none"> Specific for machine-washable wool and delicate fabrics such as sheer fabrics, bras, lingerie (silk), and other handwash-only fabrics. The WOOL/DELICATES cycle features gentle cradling and soaking to protect fibres from shrinkage/distortion. A neutral detergent and liquid detergent is recommended. 	2.0	2.0	2.0





Dry cycles

Cycle	Description & Max load (kg)	WD9*TA****	WD8*TA****	WD7*TA****
COTTON DRY	<ul style="list-style-type: none"> For general drying. 	6.0	5.0	4.0
SYNTHETICS DRY	<ul style="list-style-type: none"> A low temperature drying cycle for heat-sensitive garments. 	3.0	3.0	2.5
AIR WASH 	<ul style="list-style-type: none"> This cycle is useful for removing bad odours. 	1.0	1.0	1.0
WASH+DRY	<ul style="list-style-type: none"> For cleaning normally soiled cotton items which are declared to be washable at 40 °C or 60 °C, together in the same cycle, and to dry them in such a way that it can be immediately stored in a cupboard. This cycle is used to assess the compliance with the EU Ecodesign legislation for wash and dry. 	6.0	5.0	4.0

NOTE

- Loading the household washing machine or the household washer-dryer up to the capacity indicated by the manufacturer for the respective cycles will contribute to energy and water savings.
- The noise and remaining moisture content are influenced by the spinning speed: the higher the spinning speed in the spinning phase, the higher the noise and the lower the remaining moisture content.
- The most efficient cycle in terms of energy consumption are generally those that perform at lower temperatures and longer duration.

Options

Option	Description
 Intensive	<ul style="list-style-type: none"> For badly soiled laundry. The operation time for each cycle is longer than normal.
 Pre Wash	<ul style="list-style-type: none"> This will add a preliminary washing cycle before the main wash cycle.

Option	Description
 Bubble Soak	<ul style="list-style-type: none"> Bubble Soak helps remove a variety of stubborn stains. With Bubble Soak selected, laundry is thoroughly soaked in water bubbles for effective washing. Bubble Soak is available with and adds up to 30 minutes to 5 cycles: Cotton, Synthetics, Hygiene Steam, Mixed Load and Wash+Dry.



Dry Option

Option		Description
	Cupboard dry	<ul style="list-style-type: none"> Select to dry laundry automatically by detecting the amount and weight of the laundry. Select this to dry cotton clothing such as cotton trousers, T-shirts, and cotton underwear.
	Time Dry	<ul style="list-style-type: none"> Use to dry the laundry for a specified period of time according to the material, load, and moisture.



Delay End

You can set the washing machine to finish your wash automatically at a later time, choosing a delay of between 1 to 24 hours (in 1 hour increments). The hour displayed indicates the time the wash will finish.

1. Select a cycle. Then change the cycle settings if necessary.
2. Press **Delay End** repeatedly until a desired end time is set.
3. Press **Start/Pause**.

The corresponding indicator turns on with the clock running.

4. To cancel the **Delay End**, restart the washing machine by pressing **Power**.

Real-life case

You want to finish a two-hour cycle 3 hours later from now. For this, you add the Delay End option to the current cycle with the 3-hour setting, and press Start/Pause at 2:00 p.m. Then, what happens? The washing machine starts operating at 3:00 p.m., and ends at 5:00 p.m. Provided below is the time line for this example.

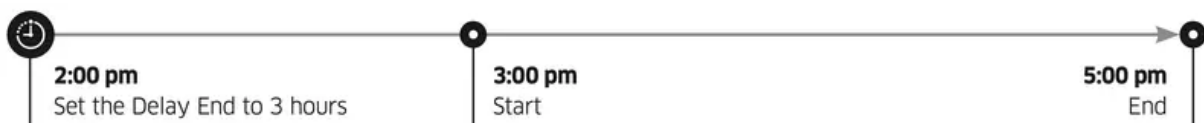





Settings



Child Lock

To prevent children or infants from accidentally starting or setting the washing machine, Child Lock locks all buttons except for the **Power** button.

- To set the Child Lock function, hold down  **Temp.** and  **Rinse** simultaneously for 3 seconds. To activate, press  **Start/ Pause**.
- To release the Child Lock function, hold down  **Temp.** and  **Rinse** simultaneously for 3 seconds.

NOTE

- In the Child Lock state, you must first release the Child Lock if you want to add detergent or laundry.
- Your setting will be kept even after restarting the machine.
- You cannot open the door after a wash cycle when the Child Lock is on. Turn the function off before opening the door to take out the laundry.



Sound On/Off

You can turn on or off the sound from the washing machine. When this function is set to Off, the melody of cycle completion, and the power-off beep will not sound. However, the other sounds stay active.

- To mute the sound, hold down  **Rinse** and  **Spin** simultaneously for 3 seconds.
- To unmute the sound, hold down again for 3 seconds.
- Your setting will be kept even after restarting the machine.

Maintenance

Keep the washing machine clean to prevent deteriorated performance and to preserve its life cycle.

Drum clean

Perform this cycle regularly to clean the drum by removing bacteria from it. This cycle heats the water between 60 °C and 70 °C, and it also removes accumulated dirt from the rubber door gasket.

1. Press **Power** to turn on the washing machine.

2. Turn the **Cycle Selector** to select **DRUM CLEAN**.

3. Press **Start/Pause**.

NOTE

- The water temperature for **DRUM CLEAN** is set to 70 °C, which cannot be changed.
- It is recommended to run the **DRUM CLEAN** cycle once every 40 washes.
- To prevent limescale, add the proper amount of detergent according to your local water hardness or add a water softener additive together with the detergent.

DRUM CLEAN reminder

Depending on the model, the DRUM CLEAN reminder is either an icon or an LED.

For icons, the icon lights up on the control panel.

For LEDs, the LED lights up next to DRUM CLEAN, or on the option area of the control panel.

- The DRUM CLEAN reminder blinks on the control panel once every 40 washes. It is advisable to perform DRUM CLEAN regularly.
- When you first see this reminder blinking, you can ignore the reminder for 6 consecutive washes. From the 7th wash, the reminder no longer appears. However, it appears again on the second 40th wash.
- Even after the last process is terminated, the “0” message may remain.
- You can record the running count of the DRUM CLEAN cycle by pressing the Power button. This does not stop or turn off the machine but marks your cycle count.
- Even if “0” does not disappear, the machine operates normally.
- It is recommended to run the cycle regularly for hygienic purposes.



Smart check

To enable this function, you must first download the Samsung Smart Washer app at the Play Store or the Apple Store, and install it on a mobile device featuring a camera function.

The Smart Check function has been optimized for Galaxy & iPhone series (applicable models only).

1. When the washing machine detects an issue to check, an information code appears on

the display. To enter Smart Check mode, press and hold



Spin and



Dry

Option simultaneously for 3 seconds.

2. The washing machine starts the self-diagnosis procedure and displays an information code if a problem is detected.

3. Run the Samsung Smart Washer app on your mobile device, and tap Smart Check.

4. Put the mobile device close to the washing machine's display so that the smartphone camera and the washing machine face each other. Then, the information code will be recognised automatically by the app.
5. When the information code is recognised correctly, the app provides detailed information about the problem with applicable solutions.

NOTE

- The function name, Smart Check, may differ depending on the language.
- If the washing machine reflects light on the display, the app may fail to recognize the information code.
- If the app fails to recognize the Smart Check code consecutively, enter the information code manually onto the app screen.

Emergency drain

In case of a power failure, drain the water inside the drum before taking out the laundry.

1. Power off and unplug the washing machine from the electrical outlet.
2. Gently press the top area of the filter cover (A) to open.

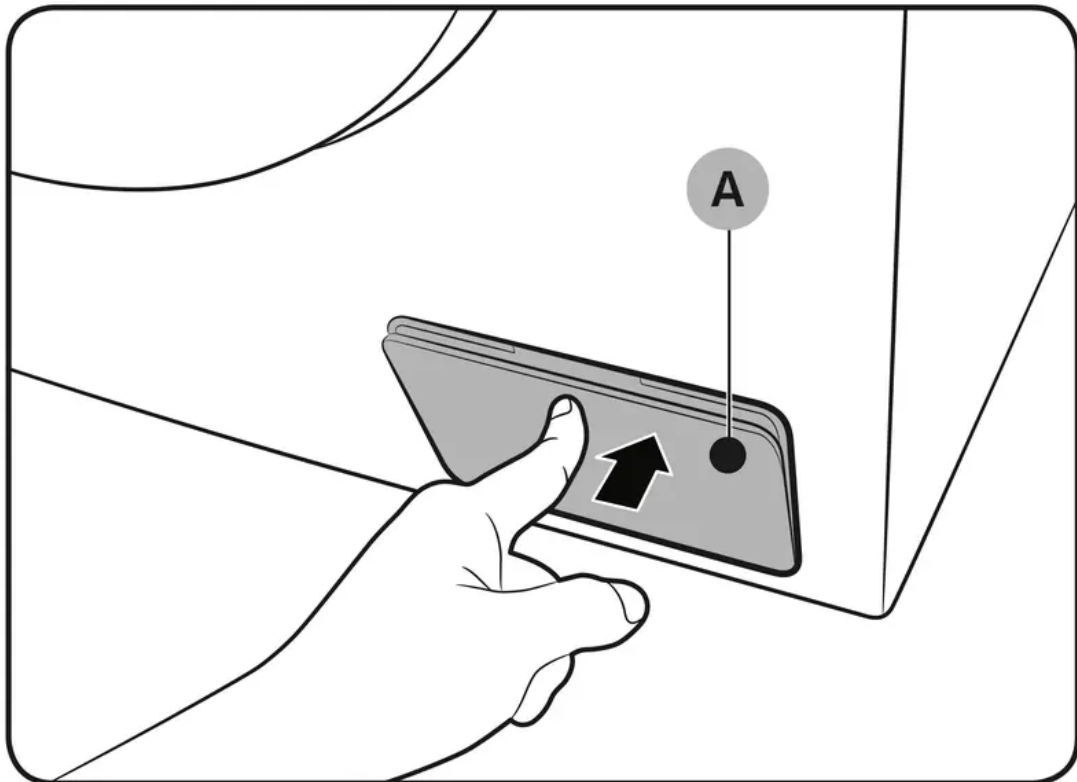

- Put an empty, spacious container around the cover, and stretch the emergency drain tube to the container while holding the tube cap (B).

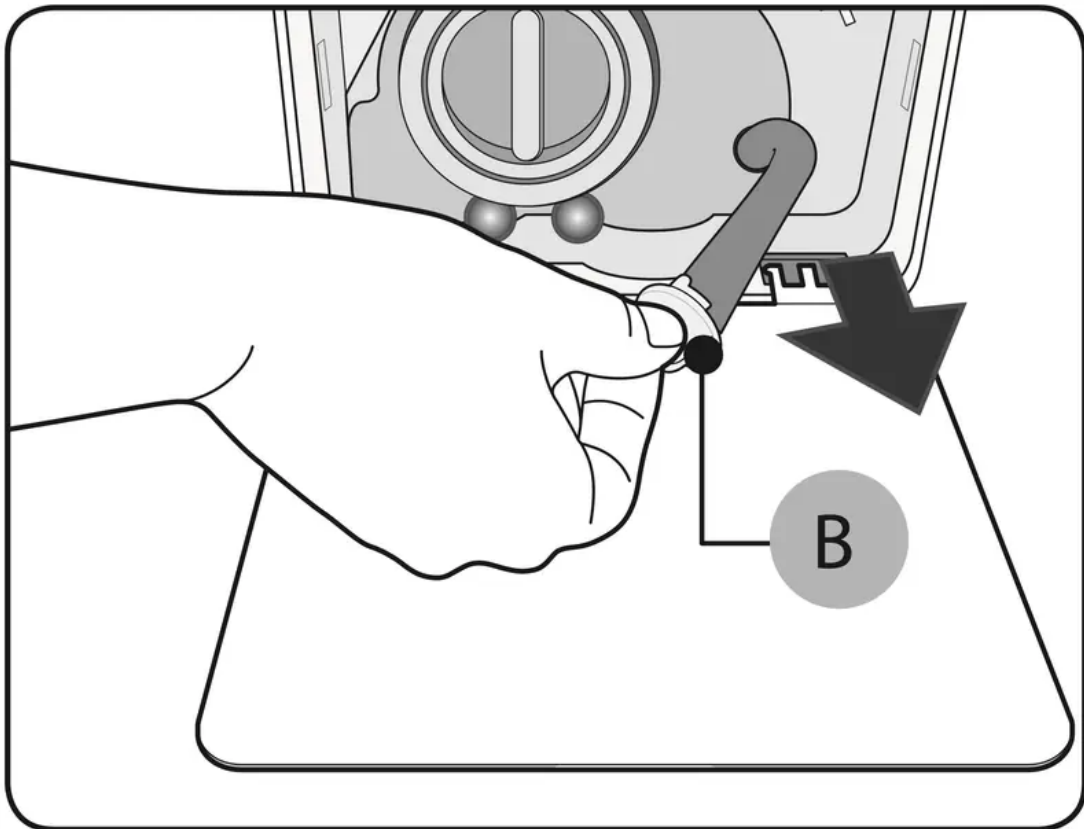

- Open the tube cap and let water in the Emergency drain tube (C) flow into the container.
- When done, close the tube cap, and reinsert the tube. Then, close the filter cover.

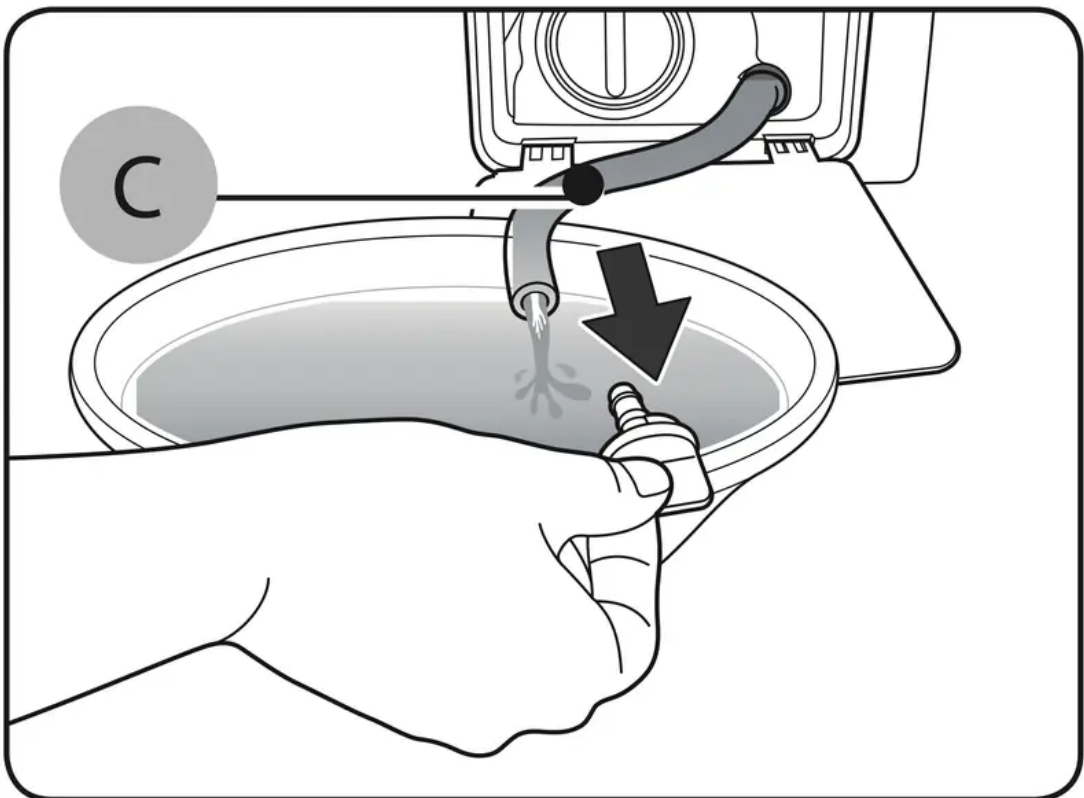

NOTE: Use a spacious container because the water in the drum may be more than expected.

Cleaning

Surface of the washing machine

Use a soft cloth with a nonabrasive household detergent. Do not spray water onto the washing machine.

Mesh filter

Clean the mesh filter of the water hose once or twice a year.

1. Turn off the washing machine, and unplug the power cord.
2. Close the water tap.
3. Loosen and disconnect the water hose from the back of the washing machine. Cover the hose with a cloth to prevent water from gushing out.

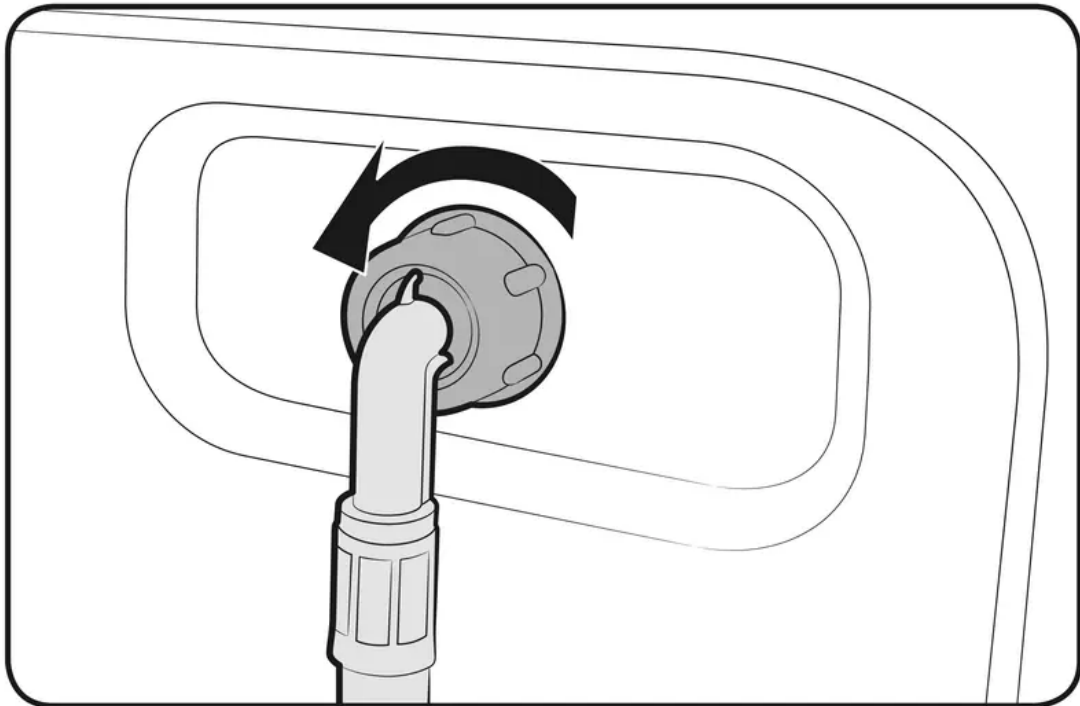

4. Use pliers to pull out the mesh filter from the inlet valve.
5. Submerge the mesh filter deeply in water so that the threaded connector is also submerged.
6. Dry the mesh filter completely in the shade.
7. Reinsert the mesh filter into the inlet valve, and reconnect the water hose to the inlet valve.

8. Open the water tap.

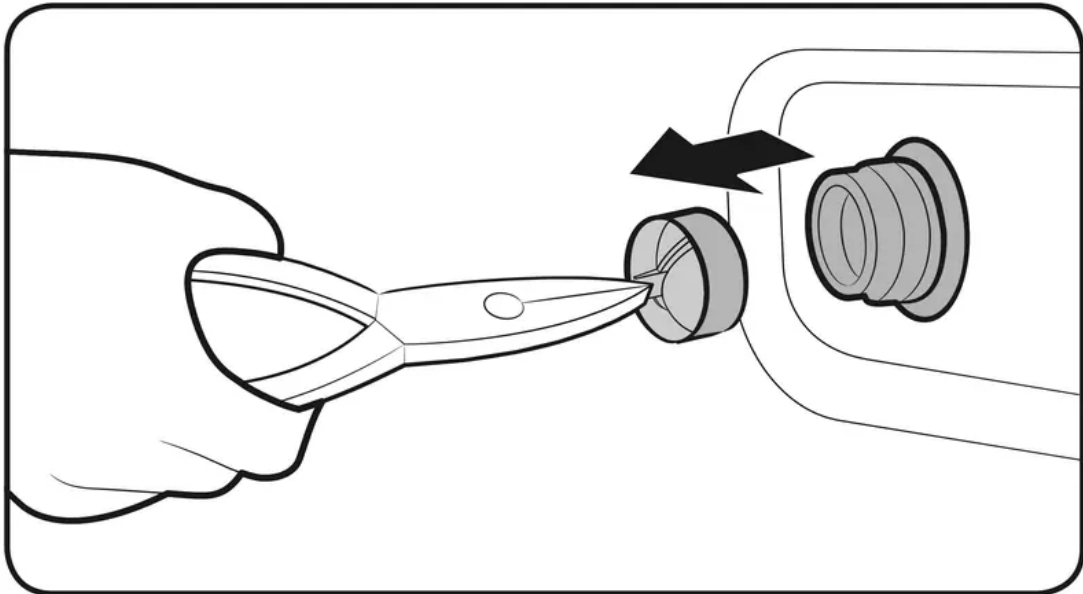

NOTE: If the mesh filter is clogged, an information code of “4C” appears on the screen.

Debris filter

Clean the debris filter bi-monthly to prevent clogging. A clogged debris filter may reduce the bubble effect.

1. Turn off the washing machine, and unplug the power cord.
2. Drain the remaining water inside the drum. See the “Emergency drain” section.
3. Gently press the top area of the filter cover to open.
4. Turn the debris filter knob to the left, and drain off the remaining water.

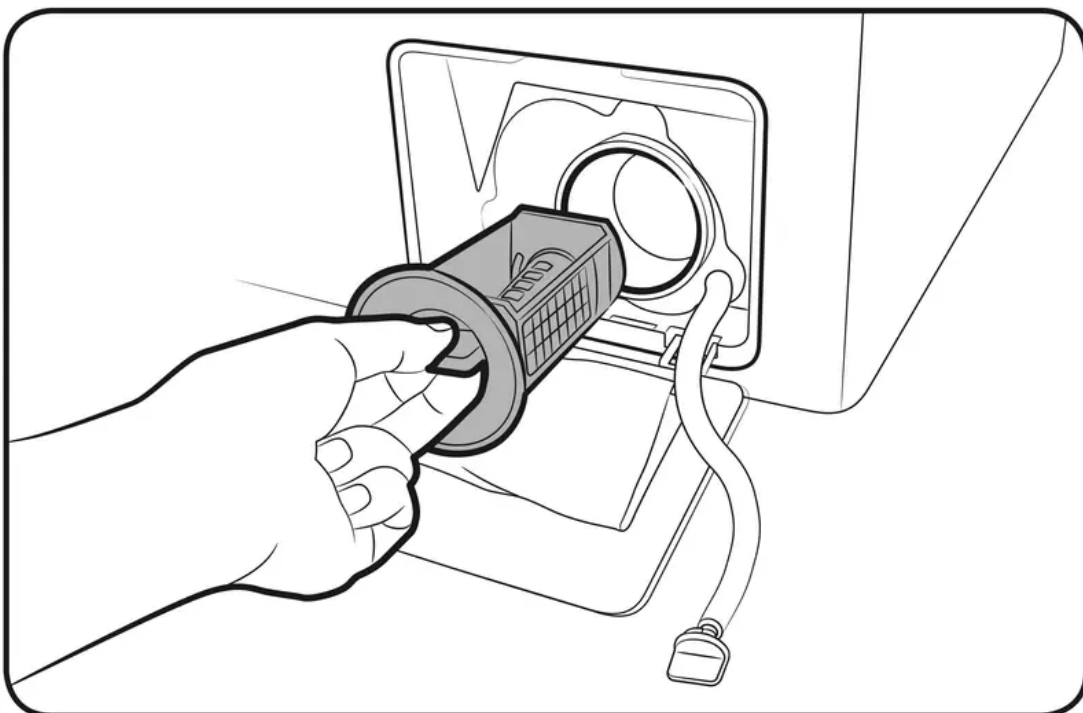

5. Clean the debris filter using soft brushes.

Make sure the drain pump propeller inside the filter is unclogged.

6. Reinsert the debris filter, and turn the filter knob to the right.

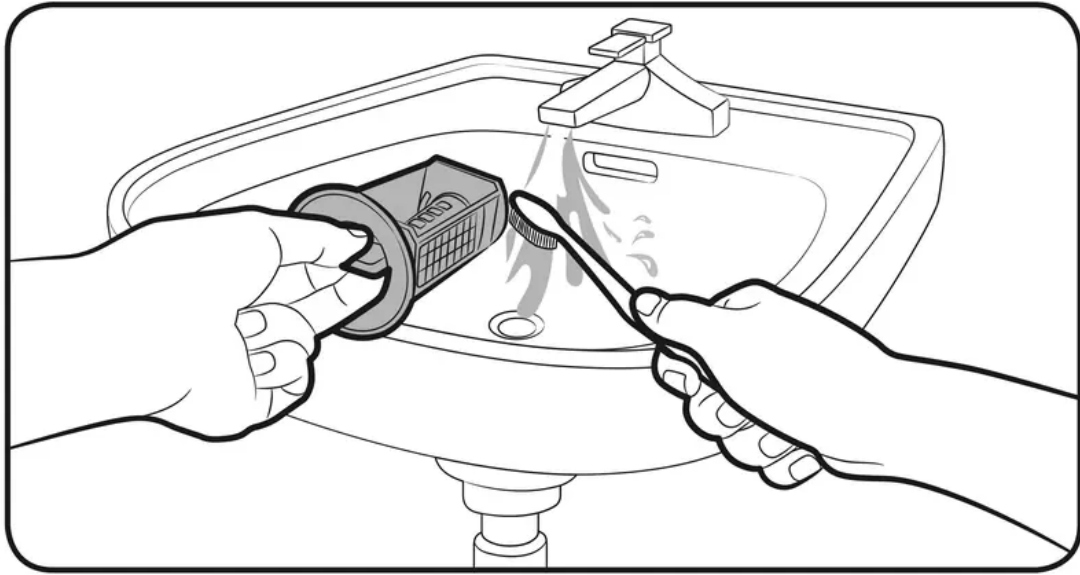

NOTE

- Some debris filters feature a safety knob that is designed to prevent accidents by children. To open the safety knob of the debris filter, push in and turn it anticlockwise. The spring mechanism of the safety knob helps open the filter.
- To close the safety knob of the debris filter, turn it clockwise. The spring makes a rattling sound, which is normal.

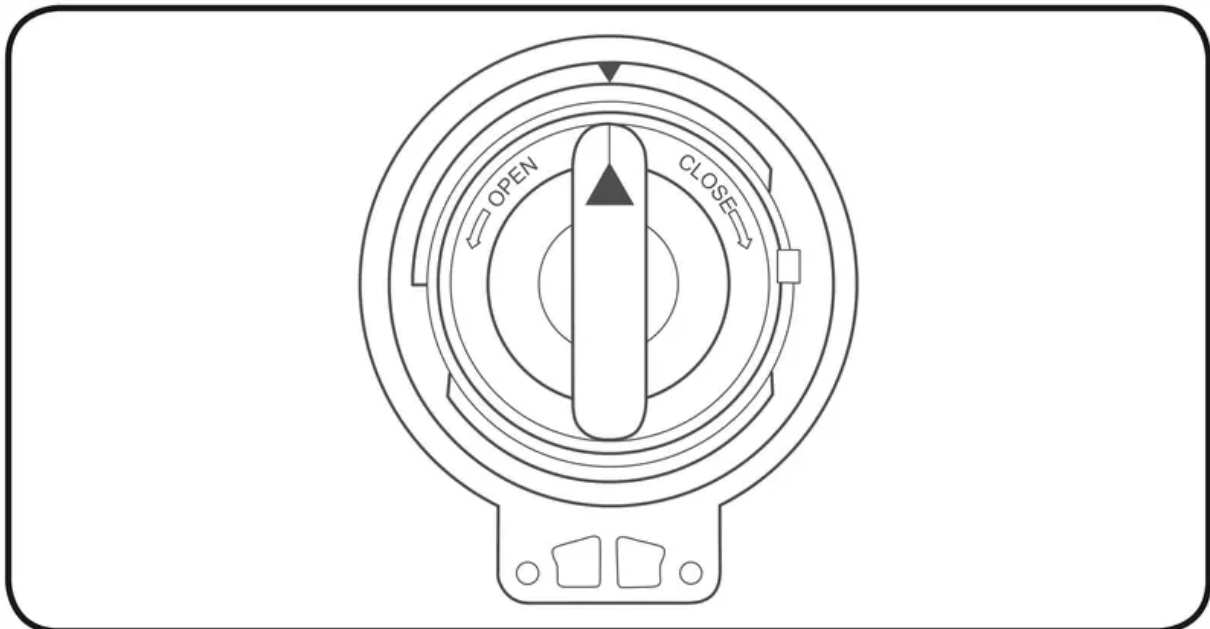

NOTE: If the debris filter is clogged, an information code of “5C” appears on the screen.

CAUTION

- Make sure the filter cap is closed properly after cleaning the filter. Otherwise, this may cause a leak.
- Make sure the filter is inserted properly after cleaning it. Otherwise, this may cause an operational failure or a leak.

Detergent Drawer

1. While holding down the release lever (A) on the inner of the drawer, slide open the drawer.

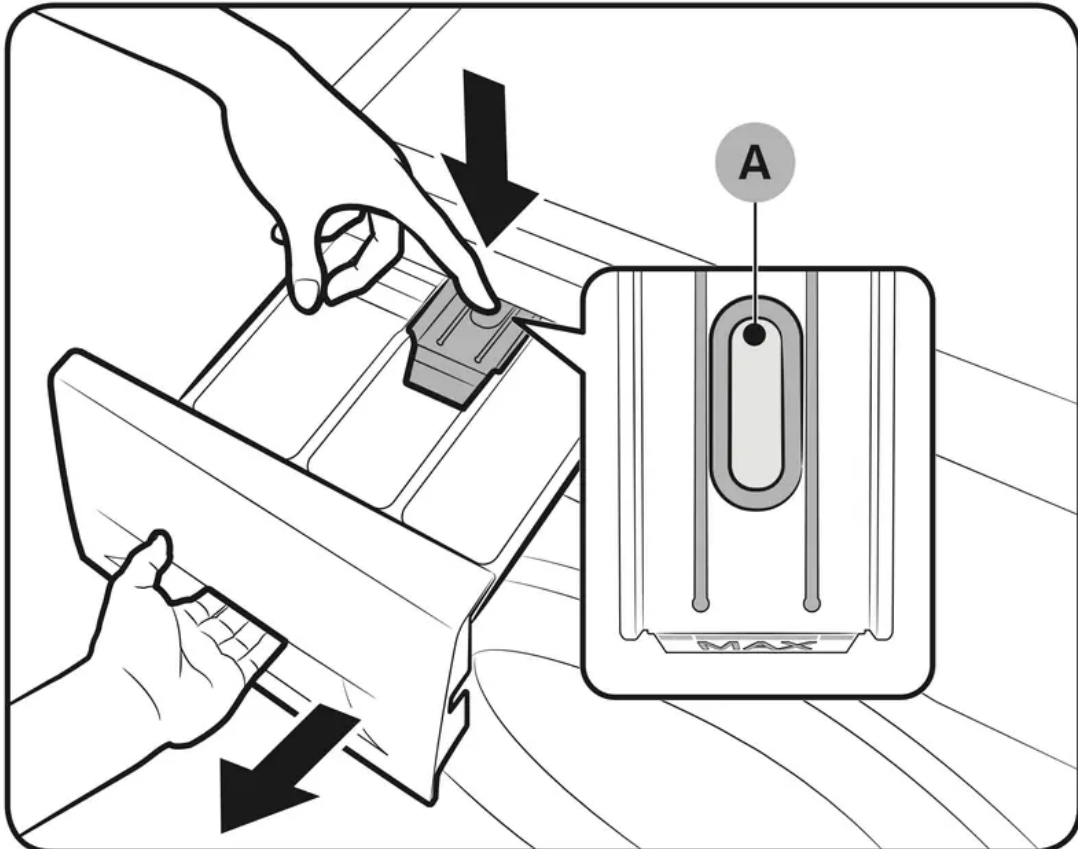

2. Clean the drawer components in flowing water using a soft brush.

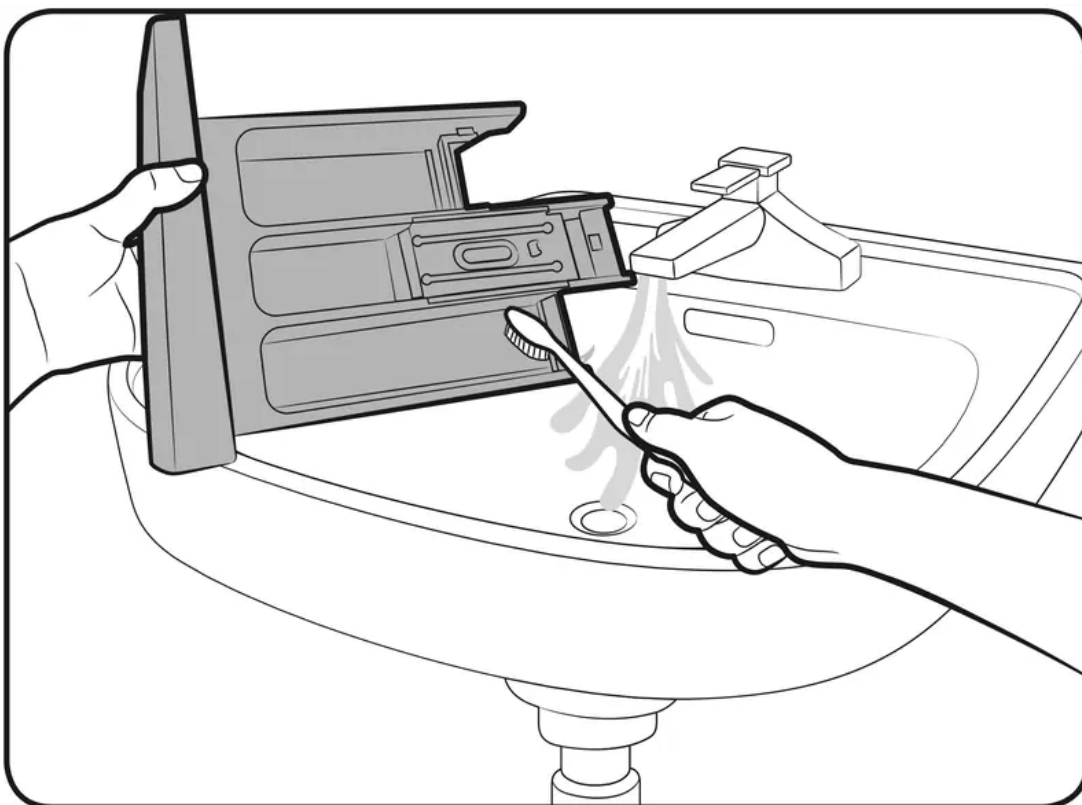

3. Clean the drawer recess using a soft brush.
4. Reinsert the release lever and the liquid detergent container to the drawer.
5. Slide the drawer inward to close it.

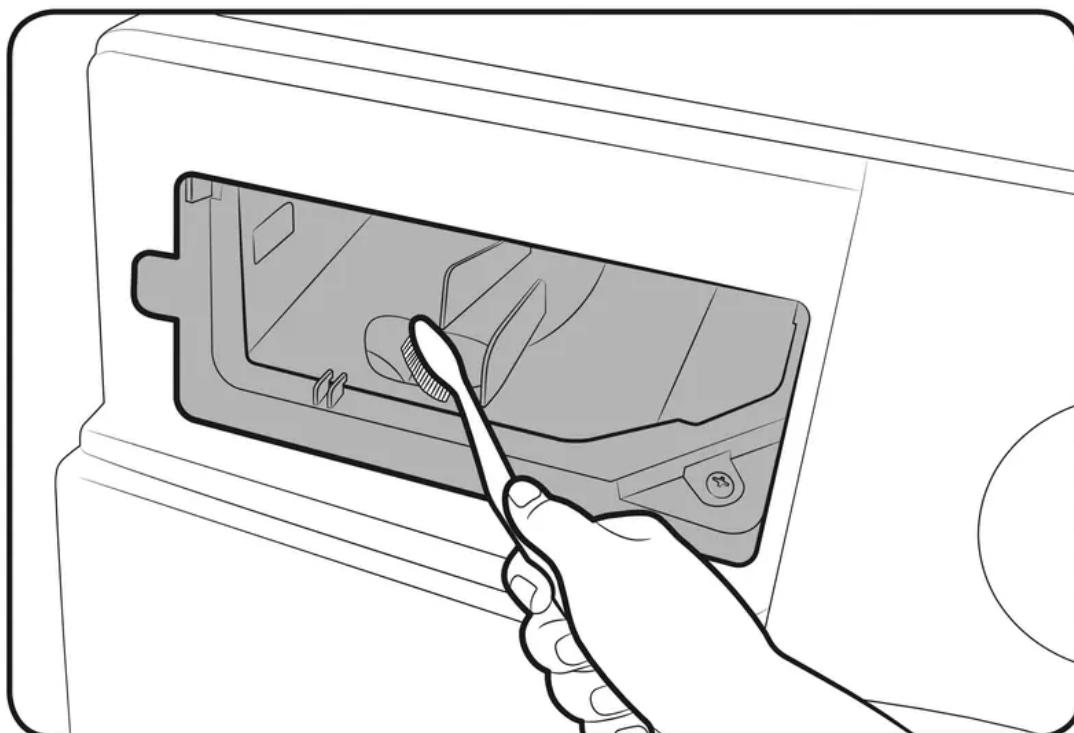

NOTE: To remove remaining detergent, perform the RINSE+SPIN cycle with the drum being empty.

Recovery from freezing

The washing machine may freeze when it drops below 0 °C.

1. Turn off the washing machine, and unplug the power cord.
2. Pour warm water over the water tap to loosen the water hose.
3. Disconnect the water hose, and soak it in warm water.
4. Pour warm water into the drum and leave it for about 10 minutes.
5. Reconnect the water hose to the water tap.

NOTE: If the washing machine still doesn't operate normally, repeat the above steps until it operates normally.

Care against an extended time of disuse

Avoid leaving the washing machine unused for an extended time.

If this is the case, drain the washing machine and unplug the power cord.

1. Turn the **Cycle Selector** to select a **RINSE+SPIN**.
2. Empty the drum, and press **Start/Pause**.
3. When the cycle is complete, close the water tap and disconnect the water hose.
4. Turn off the washing machine, and unplug the power cord.
5. Open the door to let air circulate through the drum.



Troubleshooting

If there is any problem, check the information message on the LED screen and follow the onscreen instructions.

If the problem persists, please contact the service center.

Checkpoints

If you encounter a problem with the washing machine, first check the table below and try the suggestions.

Problem	Action
<p>Does not start.</p>	<ul style="list-style-type: none"> • Make sure the washing machine is plugged in. • Make sure the door is properly closed. • Make sure the water taps are open. • Tap  Start/Pause to start the washing machine. • Make sure Child Lock  is not activated. • Before the washing machine starts to fill, it will make a series of clicking noises to check the door lock and will do quick drain. • Check the fuse or reset the circuit breaker. • Check if power is supplied properly. • Low voltage detected. <ul style="list-style-type: none"> ◦ Check if the power cord is plugged in. • Make sure laundry is not caught in the door.
<p>Water supply is insufficient, or no water is supplied.</p>	<ul style="list-style-type: none"> • Fully open the water tap. • Make sure the door is properly closed. • Make sure the water supply hose is not frozen. • Make sure the water supply hose is not kinked or clogged. • Make sure there is sufficient water pressure. • Make sure that the cold water tap and the hot water tap are properly connected. • Clean the mesh filter as it may be clogged.
<p>After a cycle, detergent remains in the detergent drawer.</p>	<ul style="list-style-type: none"> • Make sure the washing machine is running with sufficient water pressure. • Make sure the detergent is added to the centre of the detergent drawer. • Make sure the rinse cap is inserted properly. • If using granular detergent, make sure the detergent selector is in the upper position. • Remove the rinse cap and clean the detergent drawer.

Problem	Action
<p>Excessive vibrations or makes noise.</p>	<ul style="list-style-type: none"> • Make sure the washing machine is installed on a level, solid floor that is not slippery. If the floor is not level, use the levelling feet to adjust the height of the washing machine. • Make sure the shipping bolts are removed. • Make sure the washing machine is not in contact with any other object. • Make sure the laundry load is balanced. • The motor can cause noise during normal operation. • Overalls or clothes with metallic decorations can cause noise while being washed. This is normal. • Metal objects such as coins can cause noise. After washing, remove these objects from the drum or filter case. • Redistribute the load. If only one item of clothing needs washing, such as a bathrobe or pair of jeans, the final spin result might be unsatisfactory, and a “Ub” check message will be shown in the display.
<p>Does not drain and/or spin.</p>	<ul style="list-style-type: none"> • Make sure the drain hose is straightened all the way to the drain system. If you encounter a drain problem, call for service. • Make sure the debris filter is not clogged. • Close the door and press or tap Start/Pause. For your safety, the washing machine will not tumble or spin unless the door is closed. • Make sure the drain hose is not frozen or clogged. • Make sure the drain hose is connected to a drain system that is not clogged. • If the washing machine is not supplied with sufficient power, the washing machine temporarily will not drain or spin. As soon as the washing machine regains sufficient power, it will operate normally. • Make sure the drain hose is positioned correctly, depending on the connection type. • Clean the debris filter as it may be clogged.



Problem	Action
<p>The door does not open.</p>	<ul style="list-style-type: none"> • Press or tap Start/Pause to stop the washing machine. • It may take a few moments for the door lock mechanism to disengage. • The door will not open until 3 minutes after the washing machine has stopped or the power has been off. • Make sure all the water in the drum is drained. • The door may not open if water remains in the drum. Drain the drum and open the door manually. • Make sure the door lock light is off. The door lock light turns off after the washing machine has drained.
<p>Excessive suds.</p>	<ul style="list-style-type: none"> • Make sure you use the recommended types of detergent as appropriate. • Use high efficiency (HE) detergent to prevent oversudsing. • Reduce the detergent amount for soft water, small loads, or lightly soiled loads. • Non-HE detergent is not recommended.
<p>Cannot apply additional detergent.</p>	<ul style="list-style-type: none"> • Make sure the remaining amount of detergent and fabric softener is not over the limit.
<p>Stops.</p>	<ul style="list-style-type: none"> • Plug the power cord into a live electrical outlet. • Check the fuse or reset the circuit breaker. • Close the door and press or tap Start/Pause to start the washing machine. For your safety, the washing machine will not tumble or spin unless the door is closed. • Before the washing machine starts to fill, it will make a series of clicking noises to check the door lock and will do quick drain. • There may be a pause or soak period in the cycle. Wait briefly, and the washing machine may start. • Make sure the mesh filter of the water supply hose at the water taps is not clogged. Periodically clean the mesh filter.



Problem	Action
	<ul style="list-style-type: none"> • If the washing machine is not supplied with sufficient power, the washing machine will temporarily not drain or spin. As soon as the washing machine regains sufficient power, it will operate normally.
<p>Fills with the wrong water temperature.</p>	<ul style="list-style-type: none"> • Fully open both taps. • Make sure the temperature selection is correct. • Make sure the hoses are connected to the correct taps. Flush water lines. • Make sure the water heater is set to supply a minimum of 49 °C hot water at the tap. Also, check the water heater capacity and recovery rate. • Disconnect the hoses and clean the mesh filter. The mesh filter may be clogged. • While the washing machine fills, the water temperature may change as the automatic temperature control feature checks in coming water temperature. This is normal. • While the washing machine fills, you may notice just hot and/or just cold water going through the dispenser when cold or warm temperatures are selected. This is a normal function of the automatic temperature control feature as the washing machine determines the water temperature.
<p>Load is wet at the end of acycle.</p>	<ul style="list-style-type: none"> • Use the High or Extra High spin speed. • Use high efficiency (HE) detergent to reduce oversudsing. • Load is too small. Small loads (one or two items) may become unbalanced and not spin completely. • Make sure the drain hose is not kinked or clogged.
<p>Leaks water.</p>	<ul style="list-style-type: none"> • Make sure the door is properly closed. • Make sure all hose connections are tight. • Make sure the end of the drain hose is correctly inserted and secured to the drain system. • Avoid overloading. • Use high efficiency (HE) detergent to prevent oversudsing.



Problem	Action
	<ul style="list-style-type: none"> • Check the drain hose. <ul style="list-style-type: none"> ◦ Make sure the end of the drain hose is not placed on the floor. ◦ Make sure the drain hose is not clogged.
Has odours.	<ul style="list-style-type: none"> • Excessive suds collect in recesses and can cause foul odours. • Run cleansing cycles to sanitize periodically. • Clean the door seal (diaphragm). • Dry the washing machine interior after a cycle has finished.
No bubbles are seen (Bubble models only).	<ul style="list-style-type: none"> • You may not be able to see bubbles if there is too much items in the drum. • Severely contaminated laundry may not generate bubbles.

If a problem persists, contact a service center.

Information codes

If the washing machine fails to operate, you may see an information code on the screen. Check the table below and try the suggestions.



Code	Action
4C	<p>Water is not supplied.</p> <ul style="list-style-type: none"> • Make sure the water taps are open. • Make sure the water hoses are not clogged. • Make sure the water taps are not frozen. • Make sure the washing machine is operating with sufficient water pressure. • Make sure that the cold water tap and the hot water tap are properly connected. • Clean the mesh filter as it may be clogged. • When the “4C” message appears, the machine drains water for 3 minutes. In the meantime, the power button will be disabled.
4C2	<ul style="list-style-type: none"> • Make sure the cold water supply hose is firmly connected to the cold water tap. If it is connected to the hot water tap, the laundry may be deformed with some cycles.
5C	<p>Water is not draining.</p> <ul style="list-style-type: none"> • Make sure the drain hose is not frozen or clogged. • Make sure the drain hose is positioned correctly, depending on the connection type. • Clean the debris filter as it may be clogged. • Make sure the drain hose is straightened all the way to the drain system. • If the information code remains, contact a customer service centre.
dC	<p>Operating the washer with the door open.</p> <ul style="list-style-type: none"> • Make sure the door is properly closed. • Make sure laundry is not caught in the door.
OC	<p>Water has overflowed.</p> <ul style="list-style-type: none"> • Restart after spinning. • If the information code remains on the display, contact a local Samsung service centre.

Code	Action
LC, LC1	Check the drain hose. <ul style="list-style-type: none"> • Make sure the end of the drain hose is not placed on the floor. • Make sure the drain hose is not clogged. • If the information code remains, contact a customer service centre.
3C	Check the Motor for operation. <ul style="list-style-type: none"> • Try restarting the cycle. • If the information code remains, contact a customer service centre.
UC	Check the pulsator motor for operation. <ul style="list-style-type: none"> • Check if power is supplied properly. • If the information code remains, contact a customer service centre. Low voltage detected. <ul style="list-style-type: none"> • Check if the power cord is plugged in. • If the information code remains, contact a customer service centre.
HC	High temperature heating check. <ul style="list-style-type: none"> • If the information code remains, contact a customer service centre.
1C	The Water Level sensor is not working properly. <ul style="list-style-type: none"> • Try power off and restarting the cycle. • If the information code remains, contact a customer service centre. • When the “4C” message appears, the washer do draining for 3 minutes. During this time, the Power button is in operative.
AC	Check communications between main and sub PBAs. <ul style="list-style-type: none"> • Turn the machine off, and restart the cycle. • If the information code remains, contact a customer service centre.
FC	The drying fan motor is not working properly. <ul style="list-style-type: none"> • Turn the machine off, and restart the cycle.



Code	Action
	<ul style="list-style-type: none"> • If the information code remains, contact a local Samsung service centre.
0	<p>The machine does not turn off automatically after the last spinning process, and the “0” message remains.</p> <ul style="list-style-type: none"> • The machine operates normally without running the DRUM CLEAN cycle. However, it is recommended to run the cycle for hygienic purposes.

If any information code keeps appearing on the screen, contact a local Samsung service centre.

Warning

This content is compiled from multiple sources and is provided for reference purposes only. It may not be complete or fully applicable to all situations. If you are unable to resolve your issue, please contact the product manufacturer or an authorized service provider for official support.

