

## BEFORE FIRST USE:

To prevent any internal damage, it is very important to keep refrigeration units (like this one) upright throughout their journey. Please leave it standing upright and outside the box for 24 HOURS before plugging it in.

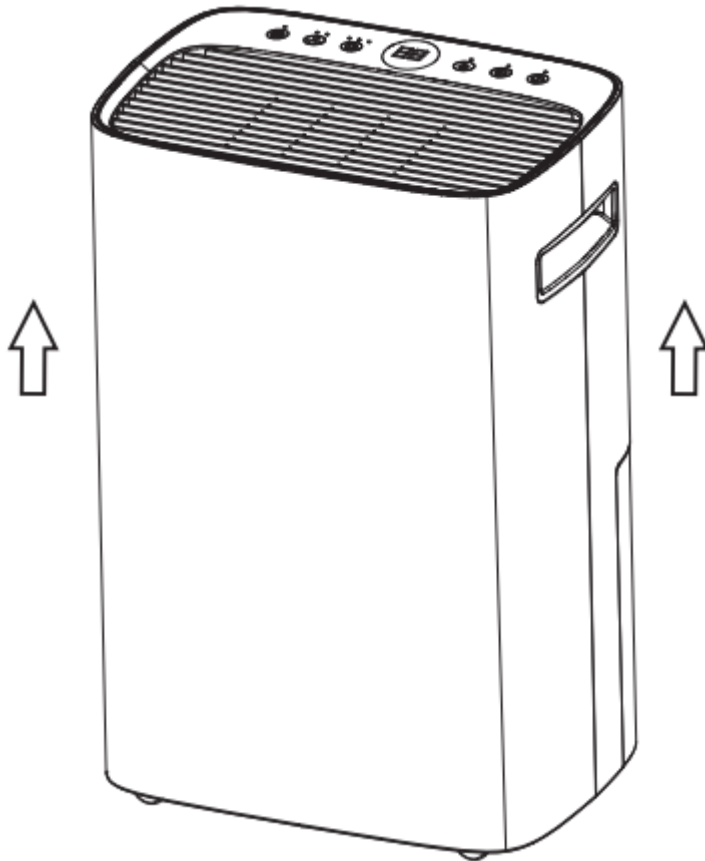

## PRECAUTIONS FOR USE

### Safety notes:

For your safety, please read the manual carefully and keep the manual to serve as a reference for product usage. This product is for home use only. Please use this product according to the installation and operation of this manual.

- Before cleaning the dehumidifier, turn off the power and unplug it from the power outlet.
- Please do not place the machine near heat or flammable dangerous goods.
- Do not insert your fingers or sticks into the air inlet or outlet.
- Always keep the machine on even surfaces, avoid placing the machine on uneven or sloping ground.

- Do not spray water, insecticides or flammable liquids on the unit.
- This machine should not be placed in a confined and narrow space.
- When the power cord is damaged, it must be replaced by a technician approved by the company.
- When using the dry clothes function, the clothes should be kept at least 15.7inches away from the air outlet to prevent water from entering the machine and damage the machine.
- The machine power wiring must be in accordance with national wiring rules, and, power line should be connected to the reliable external Naught wire.
- The fixed wiring of the machine connection must be equipped with an all-pole disconnect device (air switch) with at least 0.118inches contact opening distance Model specification of safety tube: 3.15A
- This product is not intended for use in the following crowd, (including children under 8 years old). The people who got physical slump, mental sensitivity, mental illness, mental retardation and lacks the knowledge on using this product unless with the supervision of a person who can guide and teach them to use the machine.
- This dehumidifier is designed to operate with a working environment between 41 °F (5°C)and 95°F (35°C).
- When using dehumidifier, other objects surrounding the machine at least need to keep a distance of 7.9 inches (20cm).
- As the picture show:

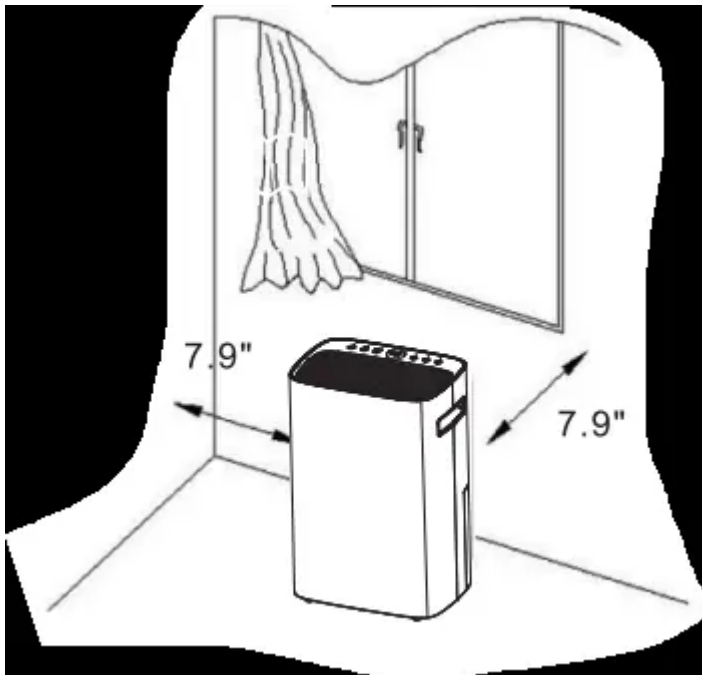

## Parts Description

Front

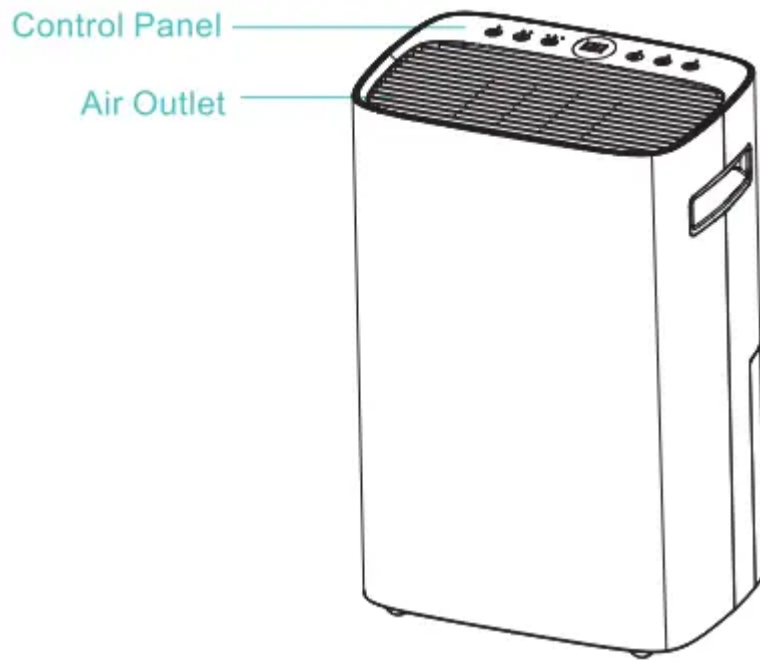

Rear

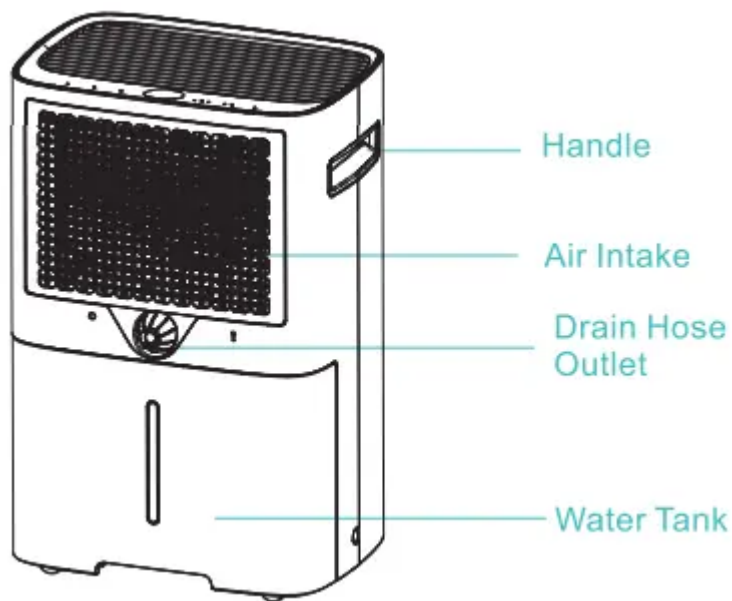

# CONTROL INTERFACE

## 1. Control Panel

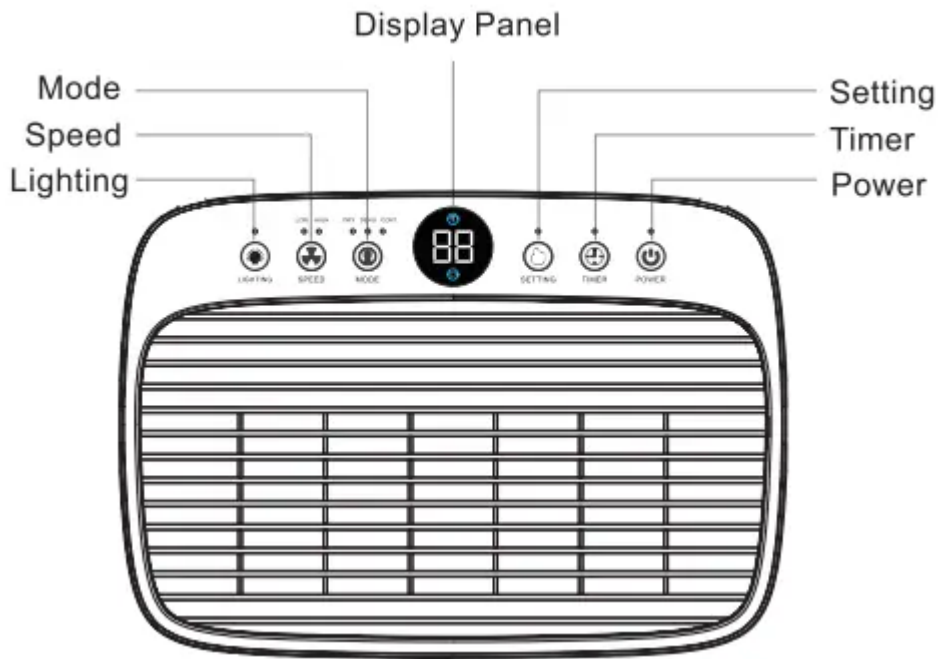

	<b>Power Button</b> Press to turn the dehumidifier on and off		<b>Dehumidify Button</b> Control the humidity setting up/down
	<b>Mode Button</b> Press mode button to choose function		<b>Timer Button</b> Press to initiate the auto start and auto stop feature
	<b>Lighting Button</b> Control the LED panel's light on/off		<b>Speed Button</b> Control the fan speed

## OPERATION INSTRUCTION

### 2. Setting

#### Mode Setting

There are Dry Clothes Mode, Dehumidify Mode, Continuous Dehumidify Mode.

When Power On, press the [Mode] button, the device will cycle through the drying, dehumidifying, and continuous dehumidify modes.

Each time you press the mode button, the working mode will switch accordingly.

Dry Clothes Mode: Humidity and fan speed cannot be set.

Dehumidify Mode: Humidity and fan speed can be set.

Continuous Dehumidify Mode: Humidity cannot be set, fan speed can be set.

## Humidity Setting

The humidity level can be set within a range of 30%RH to 80%RH in 5% increments.

- When it starts work, it will first automatically detect and show the room's humidity. In dehumidification mode (other modes are invalid), Press the "Dehumidify" button to change the humidity selection in 5% increments. A "52" Flash and show the setting humidity. When the "52" flashing, you can set the humidity within a range of 30%RH to 80%RH in 5% increments. Press Dehumidify Button" to make the humidity setting increase by 5%RH. After you don't operate the machine 5S, "52" will show the actual room humidity.
- When the humidity level is higher or drops to the level you have set, the dehumidifier will automatically begin to work or stop.
- When the humidity level is set at 30%RH, the dehumidifier will be work at continuous dehumidifying mode.

## Timer Setting

This setting is used for you to be able to set a time when you can set the timer to turn off and on the machine automatically.

1. Press the "TIMER" button to select the timer by 1-hour increments. You can set the timer up to 24 hours. It will start to do the countdown when you start the timer.
2. Press and hold the "TIMER" button for several seconds to make the selection of the timer faster.
3. If the time is set to 00, this is called the invalid time. If you set the timer successfully, the light "o" will light up. The led screen will show several seconds time, and show the current humidity.

## Timer Setting

This setting is used for you to be able to set a time when you can set the timer to turn off and on the machine automatically.

1. Press the "TIMER" button to select the timer by 1-hour increments. You can set the timer up to 24 hours. It will start to do the countdown when you start the timer.
2. Press and hold the "TIMER" button for several seconds to make the selection of the timer faster.
3. If the time is set to 00, this is called the invalid time. If you set the timer successfully, the light "o" will light up. The led screen will show several seconds time, and show the current humidity.

## Speed Button

Controls the fan speed. Press to select either High or Low fan speed. Higher fan speed will result in quicker moisture removal. Set the fan control to High for maximum moisture removal. When the humidity has been reduced and quiet operation is preferred, set the fan control to Low.



## Light Function Settings

1. In the power on state, press the [Lighting] button to make the backlight on and press the button one more time to make the backlight off.
2. If the light function is turned on except the "Power" button and the "Lighting" button on, other backlight indicators are turned off.

## Power Off Memory Function

1. The device automatically restores the working state after power on.
2. If the device is turned on and a power interruption occurred, after starting the unit again, it will keep the parameters or settings that was setup.
3. If the device is turned off and power interruption occurred, the device will still be in a power off status when turned on.

## Overflow Protection

When the bucket full of water, the machine will turn off automatically. The indicator light  will flash. After you empty the water from the bucket the indicator light  will turn off. The machine will restart to work.

## Auto Defrost Function

When the dehumidifier is running at a lower temperature, the system will automatically determine whether there is a presence of frost. If the machine determines there is a presence of a frost, it will defrost automatically.

Defrost Action







The fan runs at high wind speed when the compressor stops.

Defrost Status Display

On defrosting status, power button "o" is flashing.

## 3. Display Status Description

- After the device is set up on an electric circuit, the "POWER" button will light up when the device is on Standby (Power off) status.
- Timer indicate light "o": If the timer is set up properly, the indicator will light up, when the timer is not set up properly the indicator light will be showing off.

- The lighting button "o": When use the light up function the light will up, if don't use the light will off.
- High- speed indicate light "  ":If you set the unit to high speed fan mode, it indicator will light up.
- Low-speed indicate light "  " If you set the unit on low speed fan mode, it indicator will light up.
- Dry clothes light indicate "  " : When dry clothes mode is selected, it will be on, otherwise it will be off.
- Dehumidify mode light indicator "  " : When the device starts to dehumidify, the indicator light will on. When the room environment humidity is reach the setting humidity,the light will be flashing. Otherwise it will be off.
- continuous dehumidification mode indicator "  " : when continuous dehumidification mode is selected, it will be on, otherwise it will be off.
- Water full light indicat  : When the water tank or bucket is full, this indicatorwill be flashing.
- When the device is alarm, the display panel will appear alarm error. (The alarm error and humidity data will be flashing rotation.)
- When the device is on working, the data "55" on the display panel is the humidity value.

#### 4. Instructions for Drying Clothes

The dehumidifier can be used for drying clothes in rainy weather.

##### Step 1.

Hang the washed clothes in a small space such as cloakroom, bathroom, or storage room.

Note: Keep away the unit from the water drip from the washed clothes.

##### Step 2.

Open the dehumidifier and set the humidity level at 30%RH. It is best if you let the air outlet of the dehumidifier to blow air to the clothes directly.

1. The drying effect will vary from the thickness of clothes, the number of clothes and the size of the drying space. Theoretically, the effect will be better when clothes are few, thin and space is small.
2. The drying process would take 3-8 hours, and we suggest that continuous drainage mode is more suitable when drying clothes.

## 5. Error & Protection Code

Number	Error Code	Name of the fault	note
1	E1	Humidity sensor error	
2	E2	Defrost temperature sensor error	
3	E4	Temperature sensor error	
4	E7	Bucket is full, empty the bucket	

### Attention

When the machine signals the alarm, it will flash or display the alarm, in case there are multiple error on the unit, it will show the error in a turn display behavior.

1. If the display reads “E1”, “E2” or “E4” error codes, please turn off and unplug the unit, and check for any obstructions. Plug it in again and restart the dehumidifier.
2. When one of the above malfunctions occurs, the buzzer will alarm for a few seconds. Press any key during the alarm to release the alarm sound.

**Note:** Before starting the machine, please ensure that the air outlet has been opened, otherwise the machine will overheat. Do not pull out the power cord directly to stop the machine.

## 6. Empty the Tank or Bucket

There are two ways to remove collected water.

### Use the Bucket

When the water tank is already full, the Full Tank Alert indicator will light up, the dehumidifier will automatically shut down until the tank has been emptied and placed back to the unit.

### Ways to Empty the Water Tank

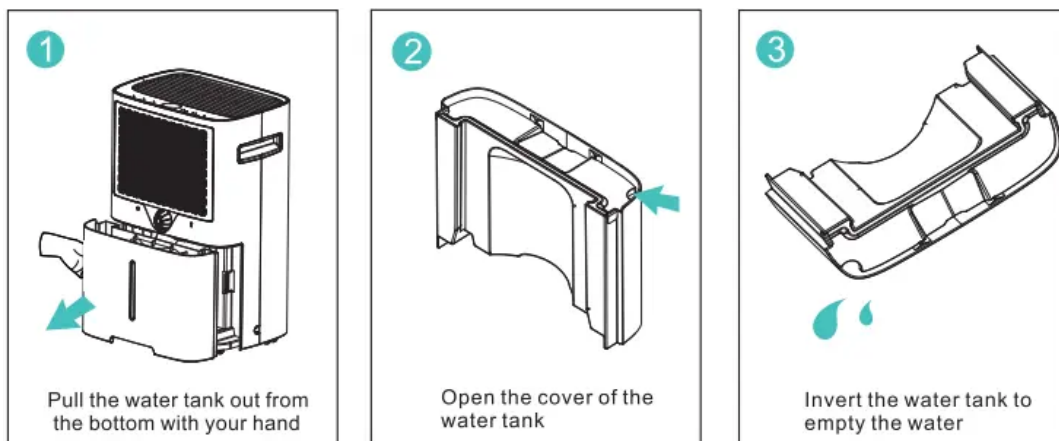

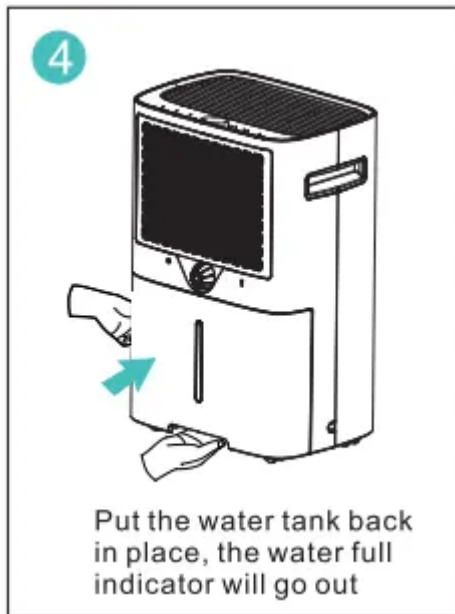

**Note:**

Do not remove the float from the watertank. If the float in the watertank is removed, the sensor may not be able to determine the water level stored in the tank properly that may lead to water overflow leak from the water tank.

If the watertank is dirty, just use cold water or warm water to clean it. Do not use detergent, steel wool, chemically treated dust cloth, gasoline, benzene, thinner or other solvents. Otherwise, it may damage the watertank and cause it to leak.

When placing back the water tank, use your hands to press the tank back in its place. If the water tank is not placed properly, sensors or protections from water overflow may not operate as expected.

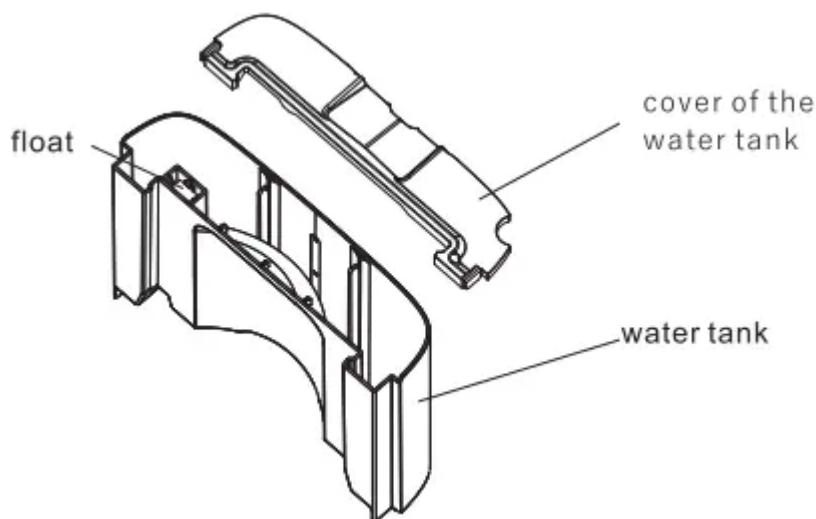

**7. Continuous Drainage**



Remove the power supply, take out the water tank, open the drain cover, insert the water pipe into the continuous drain port and push it back into the water tank. Connect the power supply to start the operation. The water outlet of the water pipe should be lower than the continuous drainage port by more than 3.9inches, and the water pipe cannot be bent.

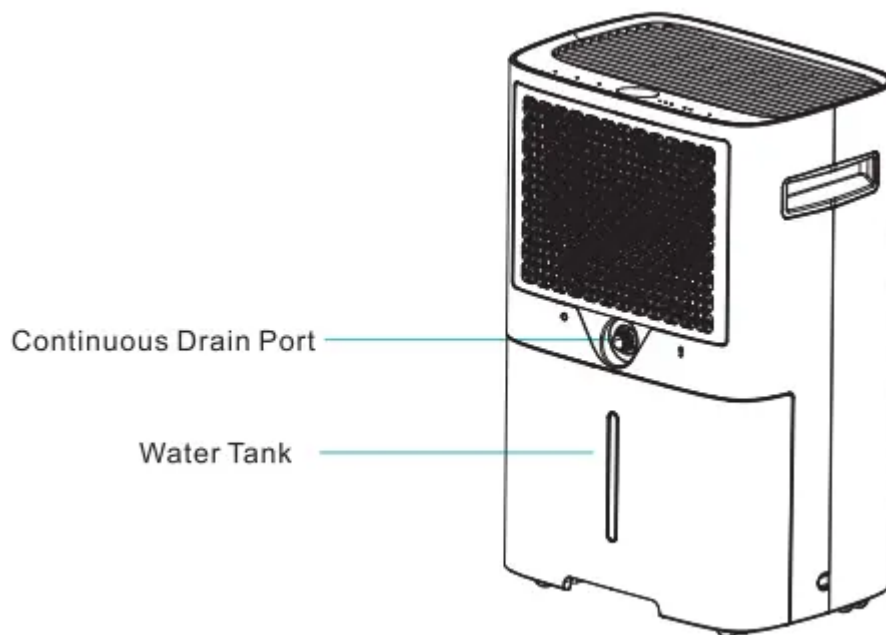
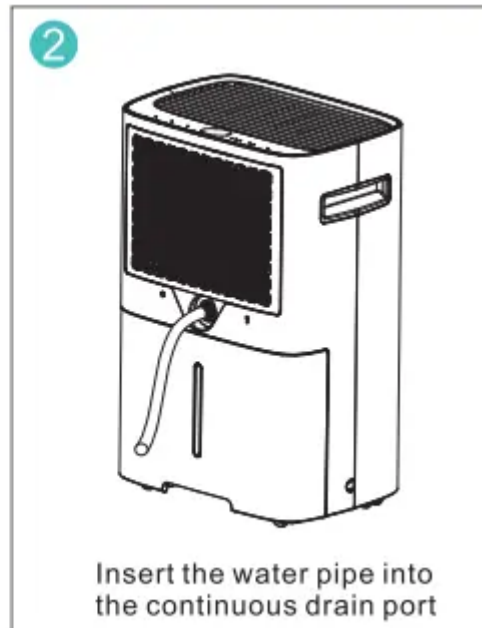
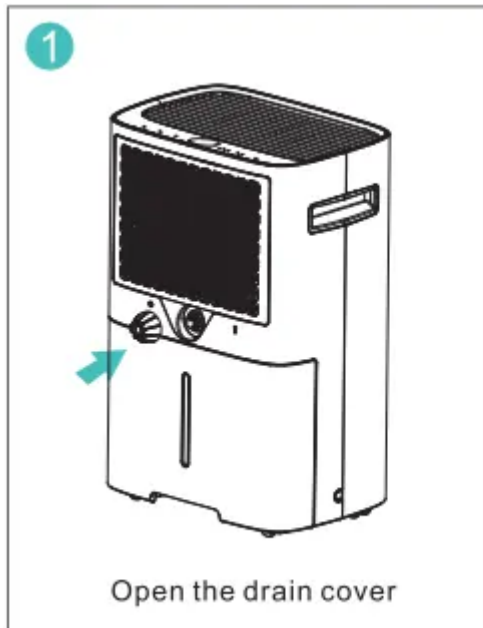

## CLEANING AND MAINTENANCE

**WARNING:** Turn the dehumidifier off and remove the plug from the wall outlet before cleaning.

### A- Cleaning the dehumidifier body

Please use only a soft and a bit wet textile or cloth to clean it.

## B- Cleaning filter

- Pull out the filter.
- Clean the filter: Use a vacuum cleaner to gently remove the dust from the surface of the filter. If the filter is very dirty, wipe it with warm water and a mild detergent and dry it completely.

Slowly insert the filter back into the fuselage.

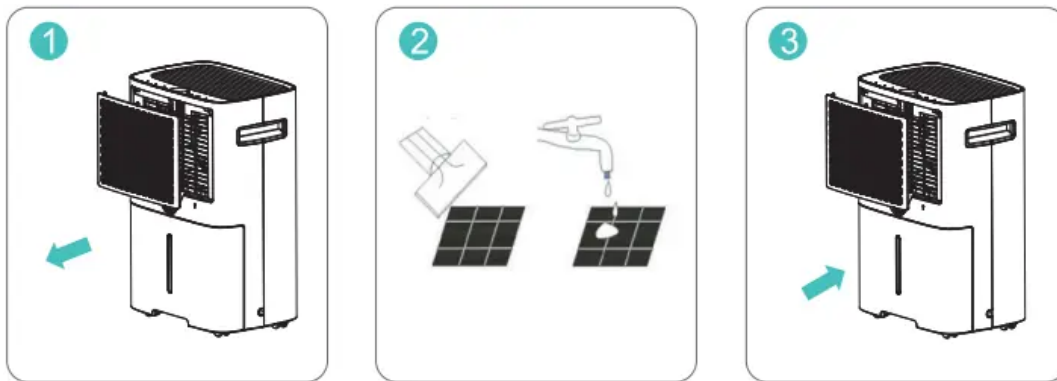

## C-Dehumidifier storage

When you want to store the dehumidifier because you don't use it for a long time. Please pay attention to the following steps:

1. Empty the water in the water tank.
2. Roll up the power cord and tie it up.
3. Clean the filter.
4. Place the machine in a cool and dry environment.

## TROUBLESHOOTING

Check the information below for troubleshooting steps that will save you time to resolve issues that may happen with the unit. The list includes most common issues. Listed below are not result of defective unit, crafts or materials in the unit. If all troubleshooting steps has been exhausted and issue is still occurring, feel free to get in touch with Kesnos Customer Service to get further assistance.

<b>Problem</b>	<b>Reason</b>	<b>Method</b>
Dehumidifier does not work	The power cord is unplugged.	Make sure that the unit's plug is inserted properly into the power outlet.
	Is the TankFull indicator blinking? (The tank is full or in a wrong position.)	Empty the water in the water tank and then reposition the tank.
	Is the room temperature above 95°F (35°C) or below 41°F (5°C).	This product does not apply to over hot or cold environment, the machine will automatically protection, it is a normal phenomenon.
	Is the room temperature between 41 °F(5°C) and 68°F(20°C) ?	When running under lower ambient temperature, the machine will automatically defrost, it is a normal phenomenon. Wait until the defrost process finish, it will restart dehumidifying again.
	The dehumidifier is in the defrosting process.	It is normal the compressor ceases while defrosting process. Wait until the defrost process finish, it will restart dehumidifying again.
	Does the room humidity is lower than or reach the preset humidity level? (The room humidity has reached the preset	Please set the humidity 5% decrease by degrees than the room humidity or set the humidity to 30%.



	<p>humidity level,the dehumidifier enters into Standby Mode and the the LCD and indicators will flashing.)</p>	
	<p>There is prevent frequent start function in the machine. Dose the machine stop working just now?</p>	<p>Please wait for more than 3 minutes.</p>
	<p>Room humidity is low.</p>	<p>The dehumidifier is designed to work in the humidity range of 30%-80%.Above or below the work humidity range, it will not work.</p>



Dehumidifier does not dry the air as it should	The air filter is dirty.	Clean the air filter.
	Is the air inlet or air outlet obstructed?	Remove the obstruction from the air inlet or outlet.
	The dehumidifier size is too small for application.	Increase the quantity of dehumidifier. Or change a higher capacity dehumidifier.
	Poor air circulation.	Please leave about 7.9inch(20cm) around the product.
	Did not allow enough time to remove the moisture.	Allow enough time to remove the moisture. When first installed, allow at least 3-4 days to maintain the desired RH.
	The room has not been sealed properly.	Check that all doors, windows and other openings are securely closed.
	Room temperature is too low, or below 41°F (5°C) (The machine will not work and or poor dehumidify efficiency in low temperature)	Please wait the temperature rises above 5°C or higher.
The dehumidifier makes loud noise when operating	The dehumidifier is not positioned level.	Move the machine to a horizontal position.



	<p>Is there blocking around the air inlet? The air filter is clogged.</p>	<p>Clean up the dirty form the on the air outlet and intake.</p>
	<p>Is the filter installed correctly?</p>	<p>Please check whether the filter packing bag removed and install correctly.</p>
Dehumidifier operates continuously	<p>Check if the dehumidifier is in CONTINUOUS MODE.</p>	<p>Don't set the humidity too low. Typically, 40-50% are good settings to use.</p>
	<p>Room humidity is too high.</p>	<p>Change humidity settings. Or change a higher capacity dehumidifier.</p>
	<p>Doors and windows are open.</p>	<p>Ensure that all doors, windows and other openings are closed.</p>
Overflow of water on floor	<p>Hose to connector or hose connection may be loose.</p>	<p>Connect the hose with the drain outlet tightly.</p>
	<p>The water bucket has not been installed properly.</p>	<p>Re-install the water bucket properly.</p>
	<p>The water tank's float been has stunk.</p>	<p>Move the float and let it can be swang freely.</p>
	<p>The magnet on the float has come off.</p>	<p>Put the magnet in right position.</p>

## SAFETY NOTE



- 1 When using, please do not put the machine at the soft and uneven ground, avoid vibration and movement.



- 2 Do not insert thin rods and hard objects into the fuselage to avoid malfunction and danger.

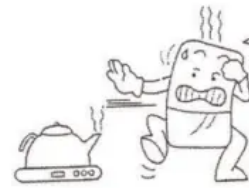

- 3 When using, please keep the machine away from heating furnace, electric kettle and other heat sources.

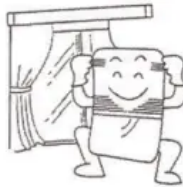

- 4 When using, make sure doors and windows are closed to get the best humidity removal effect.

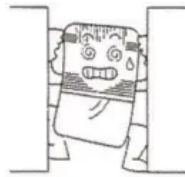

- 5 Please do not put objects around the body. If the ventilation is blocked, the dehumidification effect will be affected.

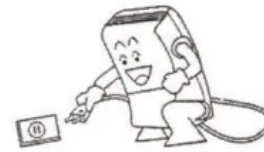

- 6 If do not use the product for a long time, please unplug the power cord.



- 7 When cleaning the dehumidifier fuselage, please use wet cloth or textile to wipe the unit's surface gently, do not splash water on the unit directly.



- 8 Please do not put any object on the dehumidifier.



- 9 Please clean the filter every two weeks (do not use hot water above 104°F, gasoline toluene)

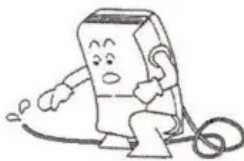

- 10 When on continuous drainage, make sure the drainage pipe is placed horizontally on the ground. Avoid the pipe to be on uneven surface or in an arch position.



- 11 After cleaning the filter, do not dry the unit under direct sunlight to avoid filter deformation.



- 12 Before moving and carrying the machine, please first pour out the water in the tank.

### Warning

This content is compiled from multiple sources and is provided for reference purposes only. It may not be complete or fully applicable to all situations. If you are unable to resolve your issue, please contact the product manufacturer or an authorized service provider for official support.

