

## Know Your Monitor

### Contents/Product Includes

Monitor, Easy Wrap ComFit Cuff, AC adapter (HEM-ADPTW5), 4 "AA" batteries, instruction manual, quick start guide

### Monitor and Arm Cuff

#### Front of the monitor

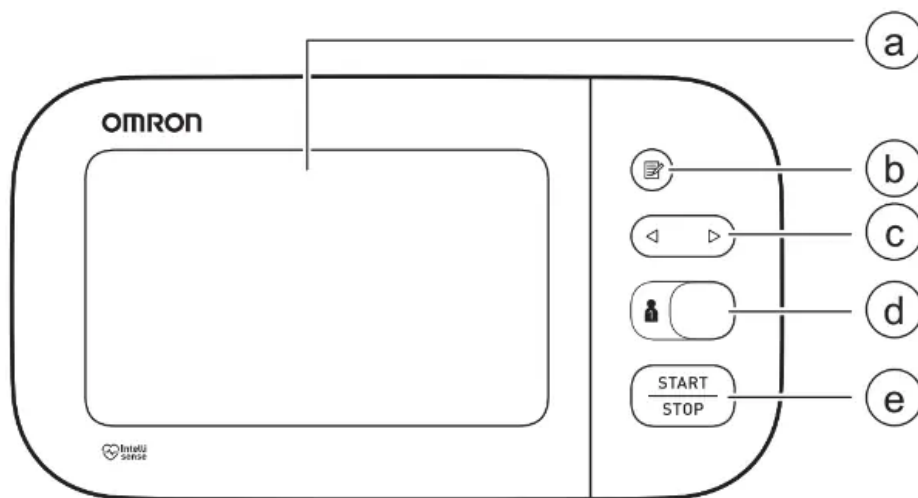

- (a) Display
- (b) [Memory] button
- (c) [Forward/Backward] buttons
- (d) [User ID selection] switch
- (e) [START/STOP] button

#### Left and right side of the monitor

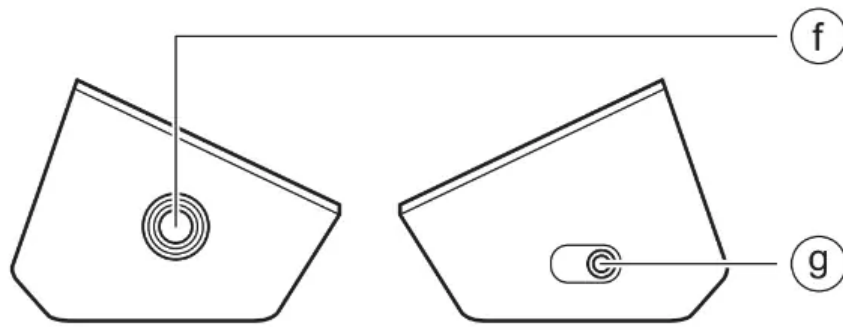

ⓕ Air jack

ⓖ AC adapter jack

**Back and bottom of the monitor**

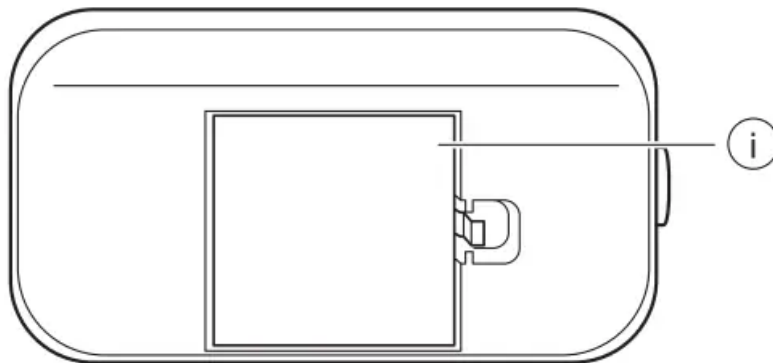
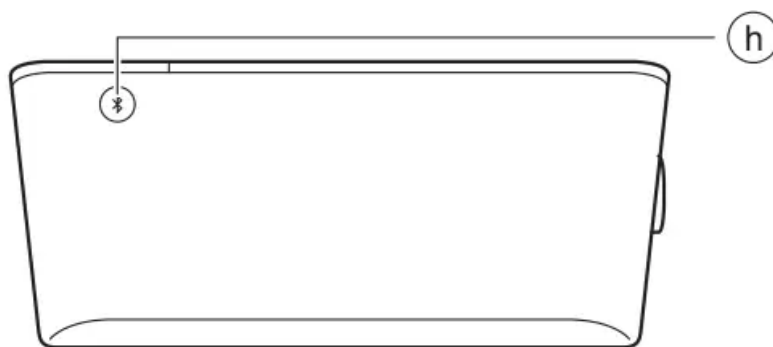

ⓗ [Connection] button  
(Date/Time)

ⓓ Battery compartment

**Arm cuff**

(Upper arm circumference: 9" - 17" (22 - 42 cm))



- ⓵ Air plug
- ⓶ Air tube

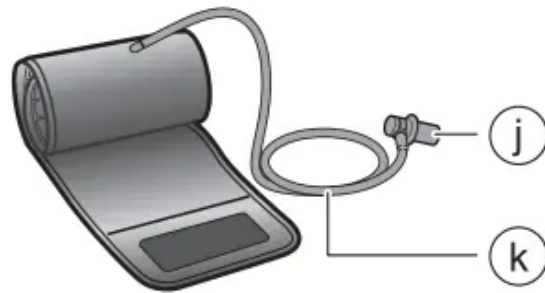

## Display and Symbols

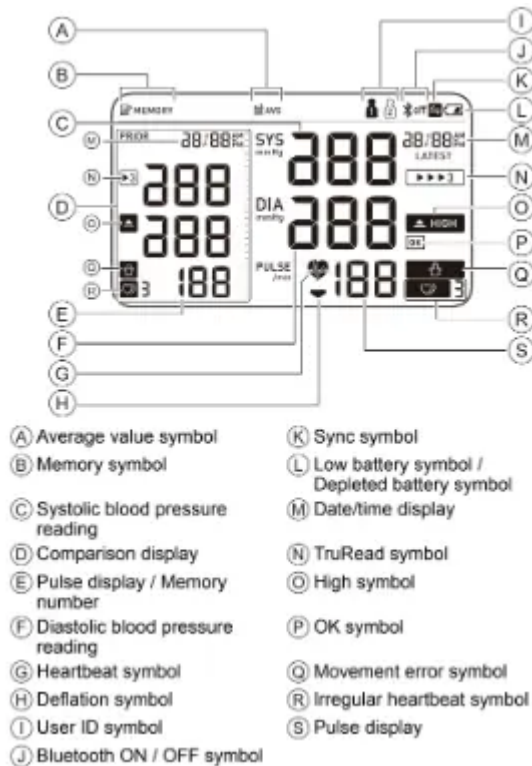

### Ⓐ Average value symbol



Flashes when viewing the average of the latest 2 or readings taken within the most recent 10 minute timeframe.

### Ⓑ Memory symbol



Appears when viewing readings stored in the memory.

### Ⓒ Systolic blood pressure reading

**D Comparison display**

Displays past readings. Refer to section 5 for more information.

**E Pulse display / Memory number**

When pressing the  button, the memory number appears for approximately 1.5 seconds before the pulse rate appears on the display.

**F Diastolic blood pressure reading**

**G Heartbeat symbol**



Flashes while taking a measurement.

**H Deflation symbol**



Appears during cuff deflation.

**I User ID symbol**



The user ID number appears when selecting the user with [user ID selection] switch.



**Bluetooth ON symbol**

Appears when your readings are being transferred.



**Bluetooth OFF symbol**

Appears when Bluetooth is disabled.

**K Sync symbol**



Flashes/appears when your data needs to be transferred because the stored memory is either almost, or completely full. Once you pair your monitor with your smart device, transfer your readings immediately before the monitor deletes the oldest reading. Up to 100 readings can be stored in the internal memory of your monitor per user.



**Low battery symbol**

Flashes when batteries are low.

 **Depleted battery symbol**

Appears when batteries are depleted.

**M** **Date/time display**

**N** **TruRead symbol**



Appears when a measurement is taken if the TruRead mode is enabled.

The TruRead mode automatically takes 3 consecutive readings at intervals you can customize and displays the average.

To enable the TruRead mode, refer to sub-section 2.4

To use the TruRead mode, refer to sub-section 3.1.

To view your readings in TruRead measurement, refer to sub-section 5.1.

**O** **High symbol**



Appears if your systolic blood pressure is  $\geq 130$  mmHg or the diastolic blood pressure is  $\geq 80$  mmHg. Refer to sub-section 1.4 for more information.

**P** **OK symbol**



Flashes when your monitor is connected to your smart device or readings are transferred successfully.

**Q** **Movement error symbol**



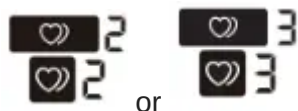

Appears with your reading when your body is moving during a measurement. If it appears, remove the arm cuff and wait for 2 to 3 minutes. Then, reapply the cuff, remain still and take another measurement.

**Irregular heartbeat symbol**



Appears when irregular rhythm is detected 2 or more times during a measurement. The symbol with the number appears as below:

Irregular heartbeat is detected 2 times: 

Irregular heartbeat is detected 3 times or more: 

An irregular heartbeat rhythm is defined as a rhythm that is 25% less or 25% more than the average rhythm detected while your monitor is measuring blood pressure.



Irregular heartbeat symbol may be displayed when the monitor detects arm movements. Refer to section 7 for more information.

**If it continues to appear, we recommend you to consult with and follow the directions of your physician.**

### Pulse display

Pulse rate appears after the measurement.

## Classification of BP (Blood Pressure)

ACC/AHA 2017 Hypertension guidelines define categories of BP in adults as below.

### Categories of BP in Adults\*

BP Category	Systolic BP	Diastolic BP
Normal	< 120 mmHg	and < 80 mmHg
Elevated	120 - 129 mmHg	and < 80 mmHg
Hypertension	Stage 1	130 - 139 mmHg or 80 - 89 mmHg
	Stage 2	≥ 140 mmHg or ≥ 90 mmHg

\* Individuals with Systolic BP and Diastolic BP in 2 categories should be designated to the higher BP category.

BP indicates blood pressure (based on an average of ≥ 2 careful readings obtained on ≥ 2 occasions).

Source: ACC/AHA 2017 High Blood Pressure Clinical Practice Guideline

## **⚠ Warning**

- NEVER diagnose or treat yourself based on your readings. ALWAYS consult with your physician.

## **Preparation**

### **Installing Batteries**

1. Push down the hook of the battery cover and pull downward.

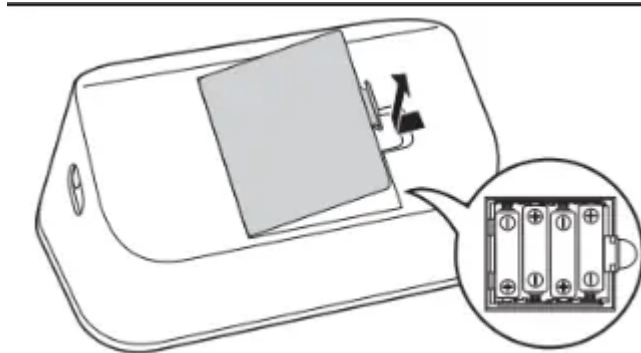

2. Insert 4 “AA” batteries as indicated in the battery compartment.

3. Close the battery cover.

As soon as batteries are correctly installed, the year flashes on the display.

Refer to sub-section 2.3 to set the date and time manually, or refer to sub-section 4.1 to pair your monitor to set the date and time automatically.

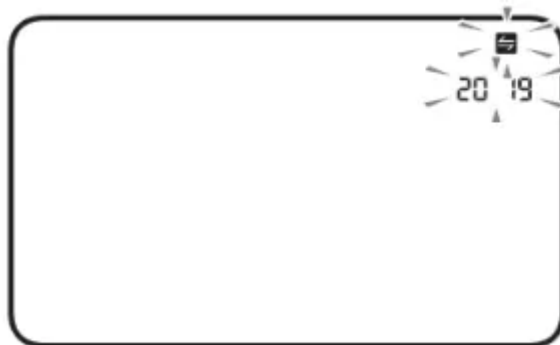

### **Note**

- When the “” symbol flashes on the display, it is recommended you replace batteries.
- To replace batteries, turn your monitor off and remove all batteries.
- Then replace with 4 new batteries at the same time.
- Replacing batteries will not delete previous readings.

- The supplied batteries may have a shorter life span than new batteries.
- Disposal of used batteries should be carried out in accordance with local regulations.

## Using the AC Adapter

### Note

- Make sure not to place your monitor in a location where it is difficult to plug and unplug the AC adapter.
- We recommend keeping batteries in your monitor at all times, even if you choose to use the AC adapter. If only the AC adapter is used without keeping batteries in your monitor, you may need to reset the date and time each time you unplug and plug back the AC adapter. The readings will not be deleted.

**1. Insert the AC adapter plug into the AC adapter jack on the right side of your monitor.**

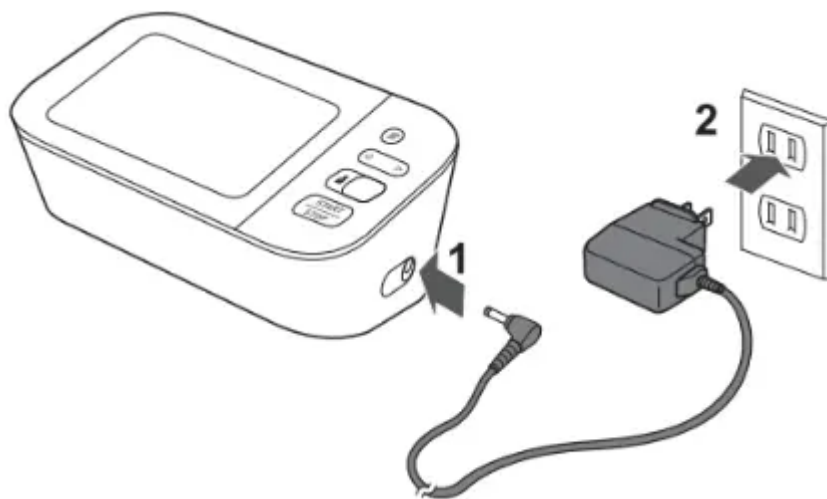

**2. Plug the AC adapter into an electrical outlet.**

To unplug the AC adapter, unplug the AC adapter from the electrical outlet and then remove the AC adapter plug from the monitor.

### Caution

- **Only use the AC adapter, the arm cuff, batteries and accessories specified for this monitor. Use of unsupported AC adapters, arm cuffs and batteries may damage and/or may be hazardous to this monitor.**

## Setting the Date and Time

### Note

- Set your monitor to the correct date and time before taking a measurement for the first time.

- The date and time will automatically be set when the monitor is paired with “OMRON connect US/CAN” app. Refer to sub-section
- As soon as batteries are correctly installed, the year flashes on the display of your monitor.

**1. If nothing is displayed, press  button (rear surface of the monitor) to display the year.**

If the year is already displayed, skip this step.

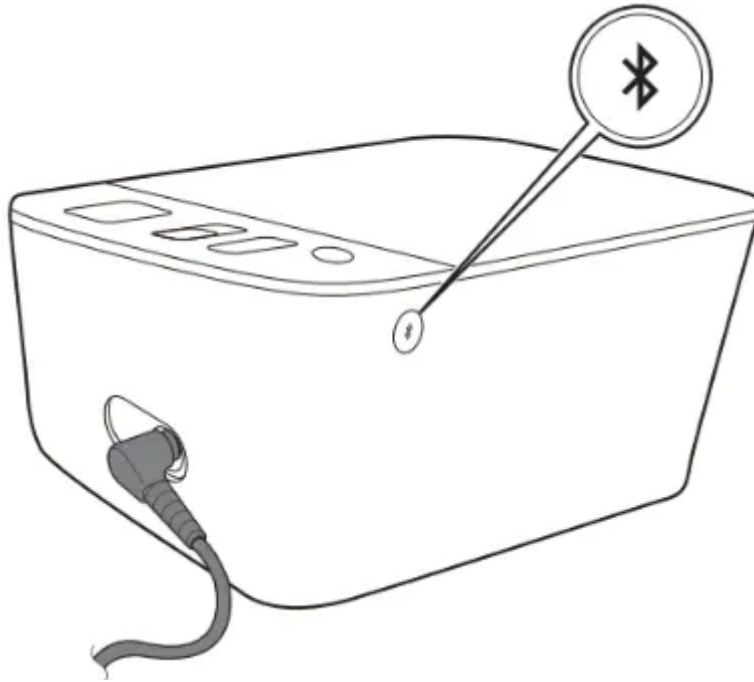

**2. Press the  or  button to adjust the year.**

Press and hold the  button to quickly advance the years.

Press and hold the  button to quickly go backwards through the years.

**3. Press the  button to confirm the year, then the month will flash. Repeat the same steps to adjust the month, day, hour, and minute.**

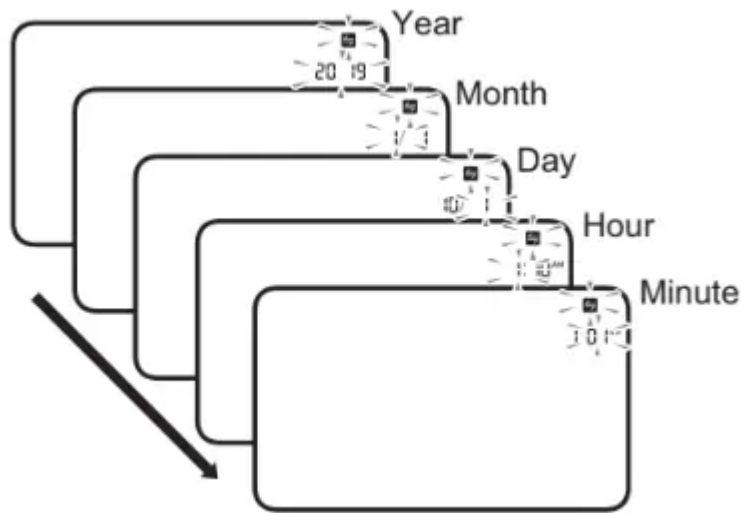

4. Press the  button to store the setting.

TruRead mode setting is displayed 3 seconds after the minutes have been set in this sequence. Refer to sub-section 2.4

**Note**

- If you need to reset the date and time, replace batteries or press the  button, then set the date and time as shown in above steps.
- If the date and time are not set, “-:-” flashes during or after measurement.

**Setting the TruRead Mode**

The TruRead mode takes 3 consecutive measurements. The monitor will inflate, take a measurement, and deflate - 3 times, separated by a short interval between each measurement.



The TruRead mode is set to “oFF” by default.

**1. Set or bypass the date and time settings.**

Follow the steps in sub-section 2.3 and set or bypass the date and time settings.

After it is completed, the “ 3” symbol appears on the display.



2. To enable TruRead mode, press the  or  button. " On" will appear in the display.



To keep TruRead mode disabled, press the  button (rear surface of the monitor).

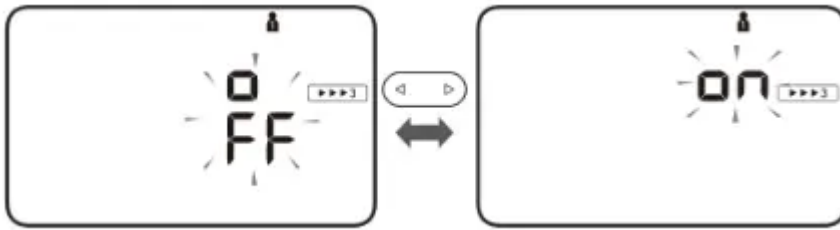

3. Press the  button to confirm.

If "on" is selected, the interval setting appears.



4. Press the  or  button to change the interval.

It can be set 15, 30, 60, or 120 seconds.

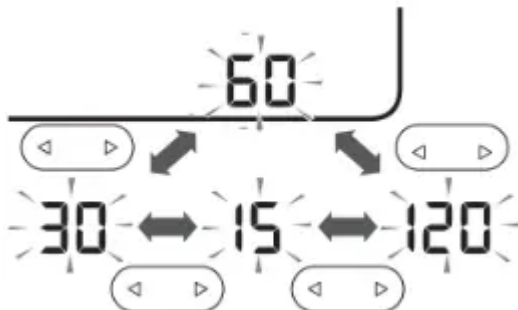

5. Press the  button to confirm.

Your monitor will automatically turn off in 3 seconds.



To take a measurement in TruRead mode, refer to "Using the TruRead Mode" in sub-section 3.1.



## Blood Pressure Measurement Tips

To help ensure an accurate reading, follow these directions:

- Stress raises blood pressure. Avoid taking measurements during stressful times.
- Measurements should be taken in a quiet place.
- It is important to take measurements at the same times each day.
- Taking measurements in the morning and in the evening is recommended.
- Remember to have a record of your blood pressure and pulse readings for your physician. A single measurement does not provide an accurate indication of your true blood pressure. You need to take and record several readings over a period of time.

### Caution

- **Avoid bathing, drinking alcohol or caffeine, smoking, exercising and eating for at least 30 minutes before taking a measurement.**
- **Rest for at least 5 minutes before taking a measurement.**

## Applying the Arm Cuff

### Note

- The following steps are for applying the arm cuff to your left arm. When you take a measurement on your right arm, follow the cuff wrap instructions for a right arm use mentioned under “To take a measurement on your right arm” located at the end of this sub- section.
- The blood pressure can differ between the right arm and the left arm, and the measured blood pressure readings can be different. OMRON recommends to always use the same arm for measurement. If the readings between both arms differ substantially, check with your physician to determine as to which arm to use for your measurements.

### Caution

- **Remove tight-fitting, thick clothing from your arm while taking a measurement.**

**1. Plug the arm cuff into your monitor by inserting the air plug into the air jack securely until it clicks.**

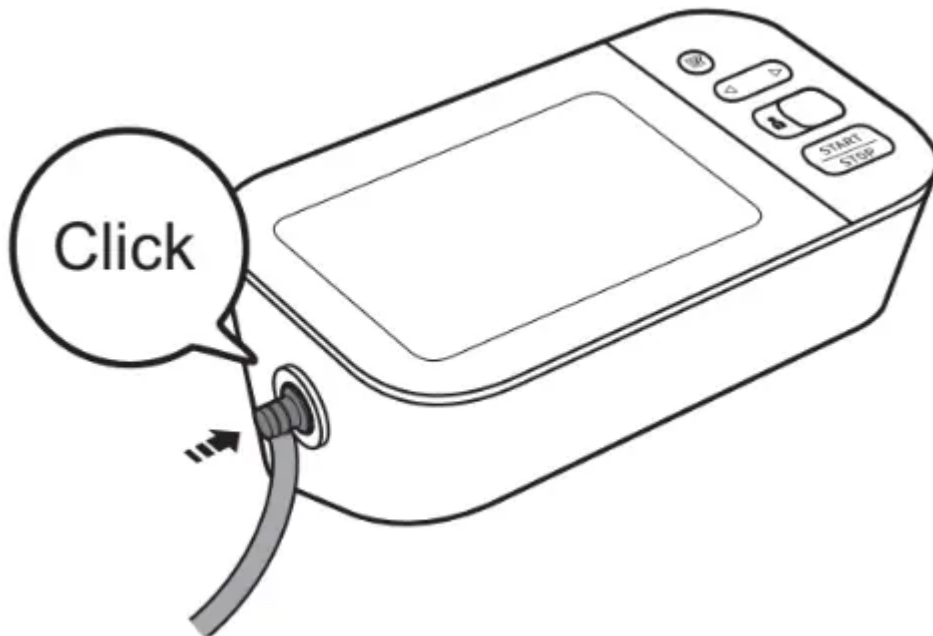

**2. Apply the arm cuff to your left upper arm.**

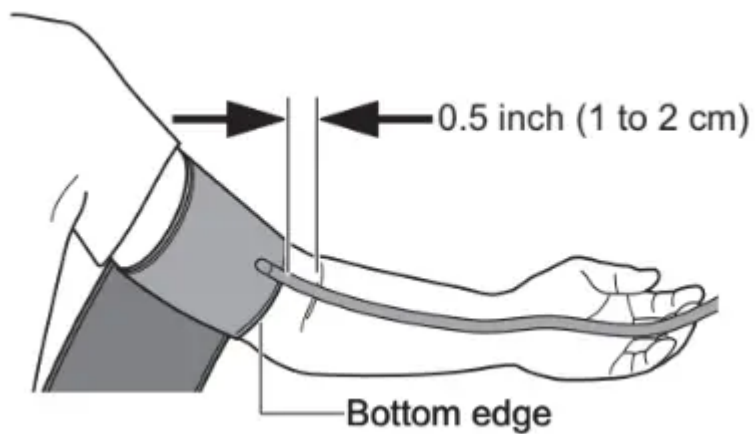

**Note**

- The bottom edge of the arm cuff should be 0.5 inch (1 to 2 cm) above the inside elbow. The air tube is on the inside of your arm and aligned with your middle finger.

**3. Make sure that the air tube is positioned on the inside of your arm and wrap the cuff securely, so it can not move around your arm.**

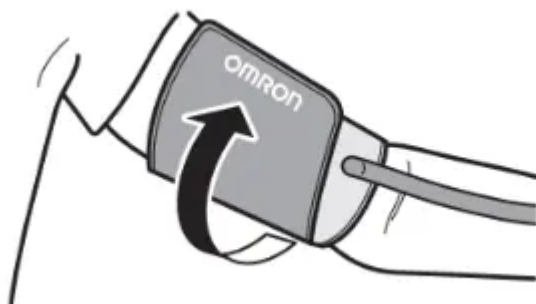

## To take a measurement on your right arm

When you take a measurement on your right arm, the air tube should run along the side of your elbow, along the bottom of your arm. Be careful not to rest your arm on the air tube.



## Sitting Correctly

To take a measurement, you need to be relaxed and comfortably seated in a room at a comfortable temperature. Place your arm on the table.

- Sit in a comfortable chair with your back and arm supported.
- Keep your feet flat and your legs uncrossed.
- The arm cuff should be placed on your arm at the same level as your heart, with the arm resting comfortably on a table.



## Selecting a User ID

Your monitor is designed to take measurements and store the readings in the memory for 2 people using the [user ID selection] switch.

1. Select your user ID (1 or 2).

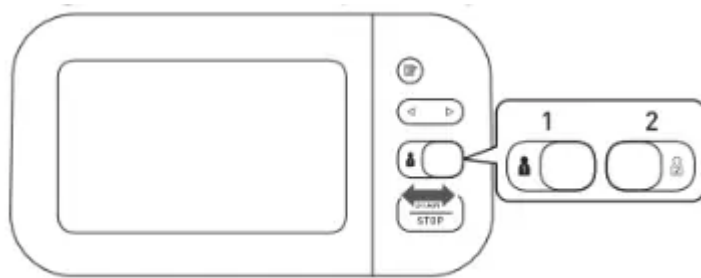

## Using Your Monitor without a Smart Device

### Taking a Measurement

You can use your monitor without pairing to a smart device. To pair your monitor with a smart device, refer to sub-section 4.1.

#### Note

- To stop the measurement, press the [START/STOP] button once to deflate the arm cuff.

#### Caution

- **DO NOT use this monitor with other medical electrical (ME) equipment simultaneously. This may result in incorrect operation of the monitor and/or cause an inaccurate reading.**
- **Remain still and DO NOT talk while taking a measurement.**

#### 1. Press the [START/STOP] button.

All symbols appear on the display before starting the measurement.

#### 2. Remain still and do not talk until the entire measurement process is complete.

The “” symbol flashes at every heartbeat.

After your monitor has detected your blood pressure and pulse rate, the cuff automatically deflates. Your blood pressure and pulse rate are displayed with the previous reading. If either the systolic or the diastolic reading is high (refer to sub-section 1.3), the “” symbol appears.

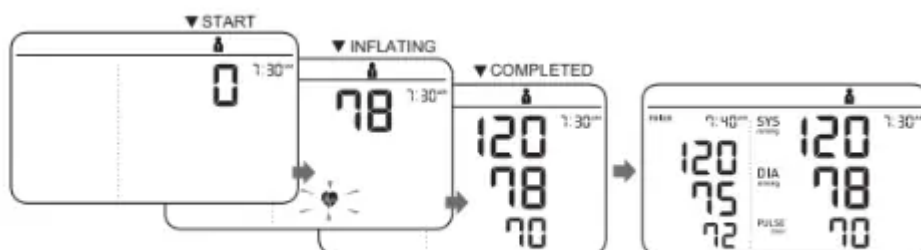

#### 3. Press the [START/STOP] button to turn your monitor off.

## Note

- Your monitor automatically turns off after 3 minutes.
- Wait 2 - 3 minutes between measurements. The wait time allows the arteries to decompress and return to their pre- measurement state. You may need to increase the wait time depending on your individual physiological characteristics.

## Using the TruRead Mode

Set the TruRead mode “on” to use the TruRead mode. Refer to sub- section 2.4.

### 1. Select your user ID.

### 2. Press the [START/STOP] button.

The arm cuff starts to inflate automatically. After the first measurement is complete, wait for the next measurement to start. The interval you selected during TruRead settings will appear on the display.

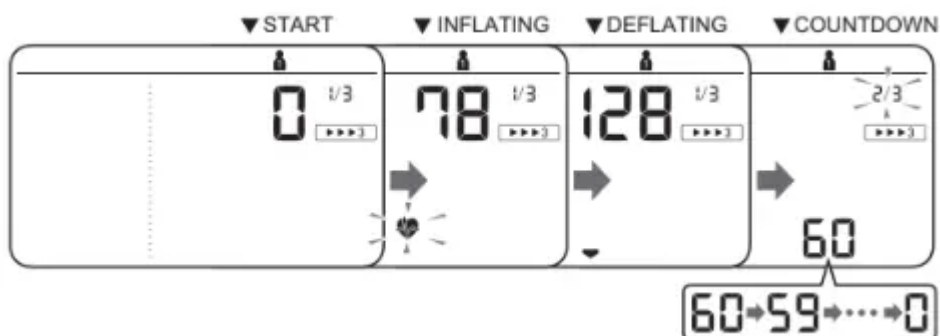

After the second measurement is complete, wait for the next measurement to start. The interval you selected during TruRead settings will appear on the display.

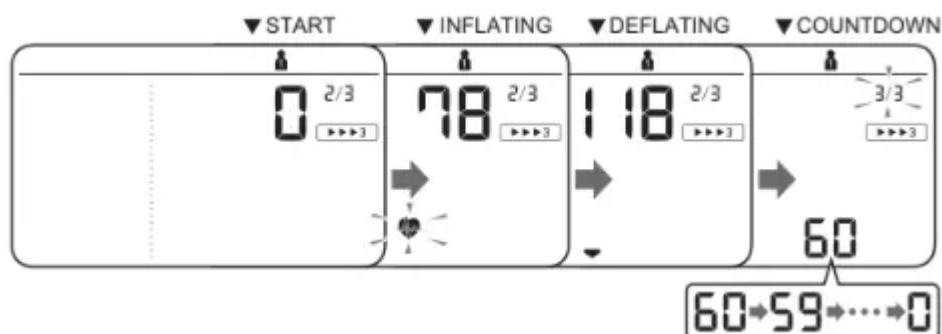

After the third measurement is complete, the average for the 3 measurements appears on the display.

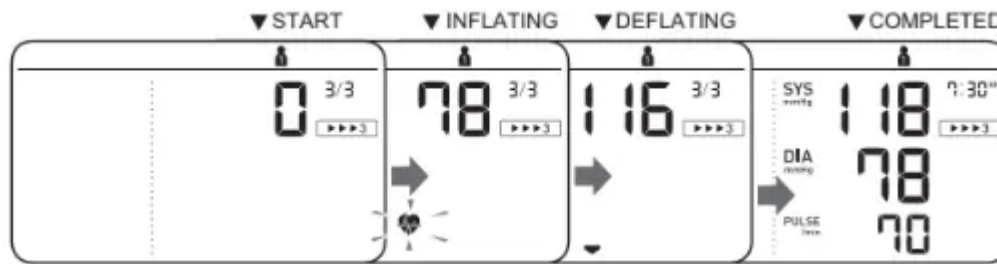

To view readings in TruRead measurement, refer to sub- section 5.1.

### Using the Guest Mode

Your monitor stores readings for 2 users in the memory. The guest mode can be used to take a single measurement for another user.

#### Note

- No readings are stored in the memory, and the TruRead mode is not available when the guest mode is selected.

#### 1. Press and hold the [START/STOP] button for more than 3 seconds.



The user ID symbol and the date/time display will disappear.

#### 2. Release the [START/STOP] button when the user ID and date/time display turn off.

The arm cuff automatically starts to inflate.

### If your systolic pressure is more than 210 mmHg

If your systolic pressure is more than 210 mmHg, take a measurement manually. After the arm cuff starts to inflate, press and hold the [START/STOP] button until the monitor inflates 30 to 40 mmHg higher than your expected systolic pressure.

#### Note

- Do not inflate above 299 mmHg.

#### Caution

- **Inflating to a higher pressure than necessary may result in bruising where the arm cuff is applied.**

# Using Your Monitor with a Smart Device

## Pairing Your Monitor with a Smart Device

The date and time on your monitor will automatically be set when you pair your monitor with your smart device.

**1. Enable Bluetooth on your smart device.**

**2. Download and install the free “OMRON connect US/CAN” app onto your smart device.**

If you already have the “OMRON connect US/CAN” app and have created your account, open the app and add your new monitor.

**3. Open the app and follow the pairing instructions shown on your smart device.**

**4. Confirm that your monitor is connected successfully.**

When your monitor is connected successfully to your smart device, the “OK” symbol appears.

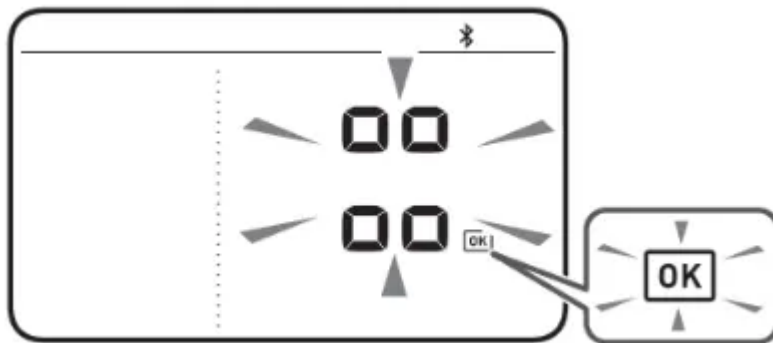

**5. Press [START/STOP] button to turn your monitor off.**

### Note

If the “Err” symbol appears, follow the instructions in the “OMRON connect US/CAN” app.

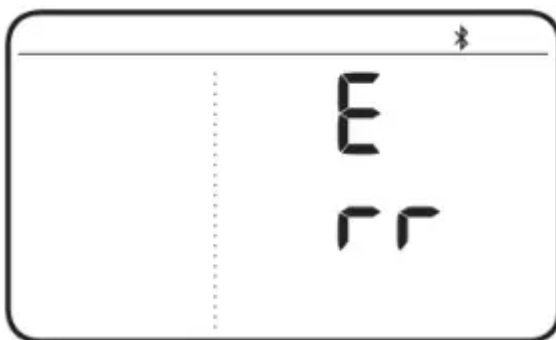

- Your monitor automatically turns off after 2 minutes.
- Be aware that OMRON will not be responsible for the loss of data and/or information in the app.

- OMRON connect US/CAN” is the only app that we recommend to use with your monitor to transfer data correctly.

## Taking a Measurement

Refer to sub-section 3.1 to start a measurement. Open the app on your smart device and follow the instructions.

### Note

- Make sure that your monitor is within 16 ft. (5m) of your smart device.

## Transferring Data Automatically/Manually

- The readings will be transferred to your smart device within 1 hour after taking a measurement.
- To transfer the readings manually, press the button.

## Disabling/Enabling Bluetooth

### Warning

- **This product emits radio frequencies (RF) in the 2.4 GHz band. DO NOT use this product in locations where RF is restricted, such as on an aircraft or in hospitals. Turn off the Bluetooth feature in this monitor and remove batteries when in RF restricted areas. For further information on potential restrictions refer to documentation on the Bluetooth usage by the FCC.**

Bluetooth is enabled as default.

1. When your monitor is off, press and hold the  button (rear surface of the monitor) for more than 10 seconds.

"oFF" flashes 3 times.

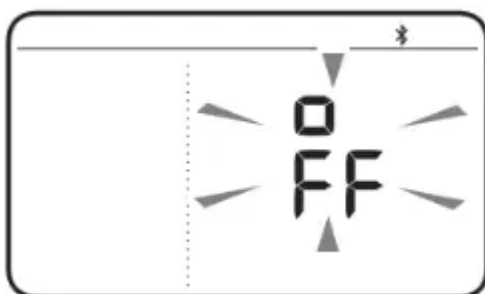

2. Press the [START/STOP] button to turn your monitor off.

### Note

- To enable Bluetooth, press and hold the  button for more than 2 seconds. "on" appears on the display.

- Your monitor automatically turns off 2 minutes after the completion.
- When Bluetooth is disabled, the “ off” symbol appears.

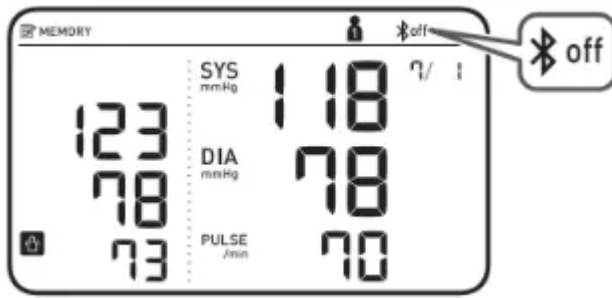

## Using Memory Function

Your monitor automatically stores up to 100 readings per user.

### Note

- This monitor can be used by multiple users. Refer to sub-section 2.8 to switch user. Make sure which user ID stores your own readings.

## Viewing the Readings Stored in Memory

1. Select your user ID.

2. Press the  button.

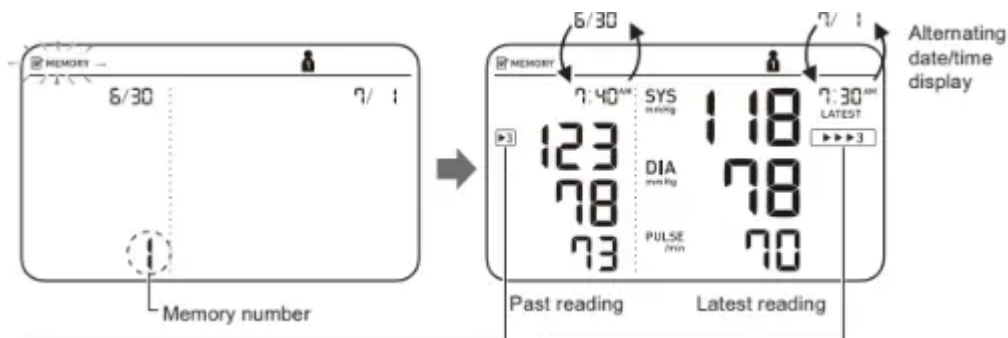

If the past reading was taken in TruRead mode, the “” symbol appears and the reading shown on the left is the average of 3 measurements.



If the latest reading was taken in TruRead mode, the “” symbol appears and the reading shown on the right is the average of 3 measurements.

After a memory number appears, the latest reading will appear with a past reading. A past reading will appear in the comparison display on the left.

**Note**

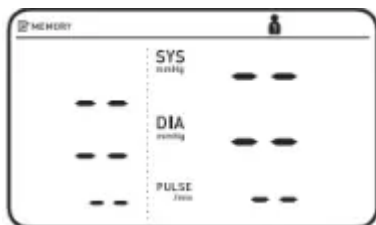
- If the reading is high (refer to sub- section 1.3), the “  ” symbol appears.
- If there are no readings stored in the memory, the screen to the right is displayed.
- If the memory is full, new readings will replace the old readings, starting with the oldest reading.





3. Press the  or  button repeatedly to scroll through the previous readings stored in the memory.

 To view the older readings

 To view the more recent readings

**To view individual readings in TruRead measurement**

The readings with the TruRead symbols (  /  ) are the averages for the consecutive 3 measurements. To view the individual readings, press the  button (rear surface of the monitor) while the TruRead average is displayed.

1. When a TruRead reading is the past reading displayed on the left side:



2. When a TruRead reading is the latest reading displayed on the right side:

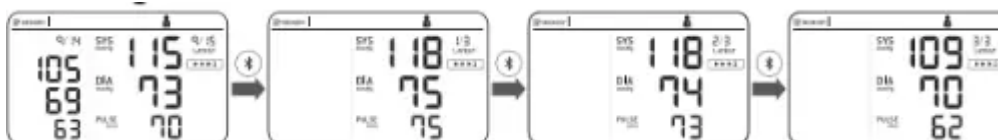

3. When TruRead readings are the past and the latest readings displayed in both of left and right side:



## Viewing the Average Reading

Your monitor can calculate an average reading based on the latest 2 or 3 readings taken within the most recent 10 minute timeframe.

1. Select your user ID.

2. When your monitor is off, press and hold the  button for more than 3 seconds.

The “  AVG ” symbol flashes.

### Note

- If there are only 2 readings in the memory for that period, the average will be based on these 2 readings.
- If the average reading is high (refer to sub-section 1.3), the “  ” symbol appears.

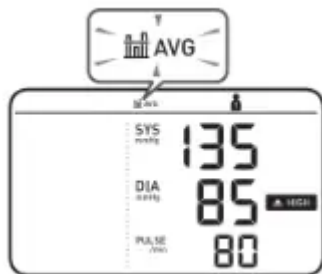

## Other Settings

### Deleting All Readings Stored in Memory

1. Select your user ID.

2. Press the  button.

After a memory number appears, the latest reading will appear with a past reading.

3. While holding the  button down, press and hold the [START/STOP] button for more than 3 seconds.

The display to the right flashes.

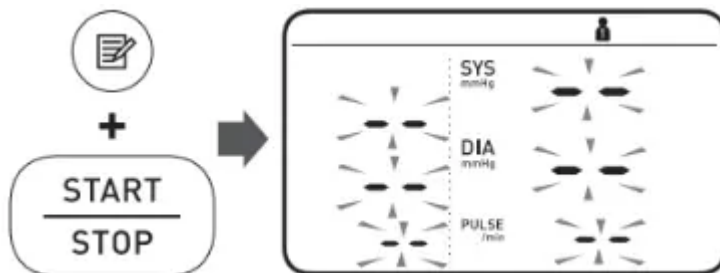

4. While holding the  button down, press and hold the [START/STOP] button for more than 3 seconds.

The display stops flashing, then all readings are deleted.

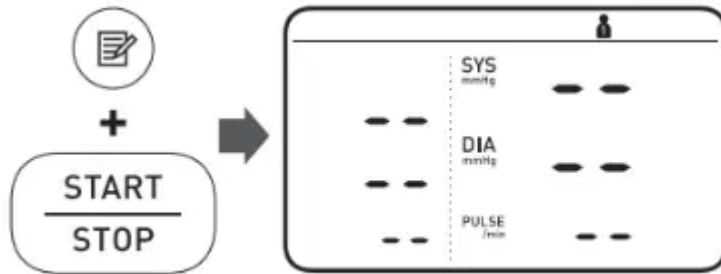

5. Press [START/STOP] button to turn your monitor off.

#### Note

- All readings will be deleted. You cannot partially delete the readings stored in the memory.
- Your monitor automatically turns off after 2 minutes.

### Restoring Your Monitor to the Default Settings

To delete all the information stored in your monitor, follow the instructions below. Make sure that your monitor is turned off.

1. While holding the  button (rear surface of the monitor) down, press and hold the [START/STOP] button for more than 3 seconds.

The display to the right flashes.

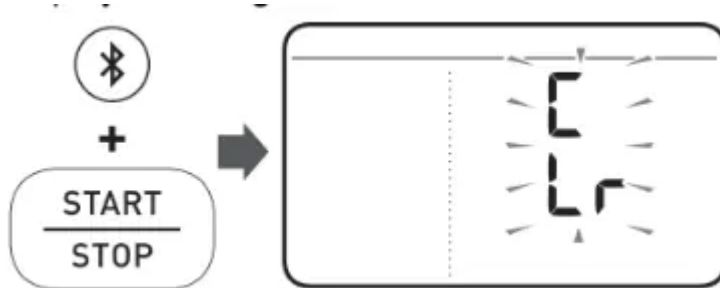

2. While holding the  button down, press and hold the [START/STOP] button for more than 3 seconds.

The display stops flashing, then your monitor is restored to the default settings.

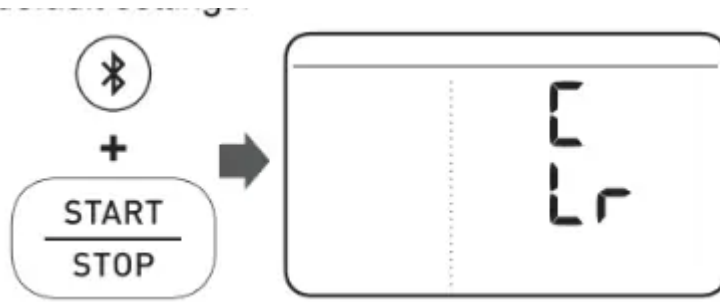

### 3. Press [START/STOP] button to turn your monitor off.

#### Note

- Reverting to the default setting of your monitor does not delete the information in the app.
- Your monitor automatically turns off after 3 minutes.
- You will need to re-pair your monitor when using the monitor again. Without re-pairing, your readings will not be transferred to your app.

## Error Messages and Troubleshooting

If any of the below problems occur during measurement, check to make sure that no other electrical device is within 12 inches (30 cm). If the problem persists, refer to the table below.

**E1** appears or the arm cuff does not inflate.

1. Air plug is not completely plugged into the monitor.
  - Insert the air plug securely. Refer to sub- section 2.6.
2. The arm cuff is not applied correctly.
  - Apply the arm cuff correctly, then take another measurement. Refer to sub-section 2.6.
3. Air is leaking from the arm cuff.
  - Replace the arm cuff with a new one. Refer to section 9.

**E2** appears or a measurement cannot be complete after the arm cuff inflates.

1. You move or talk during a measurement and the arm cuff does not inflate sufficiently.
  - Remain still and do not talk during a measurement. If “E2” appears repeatedly, inflate the arm cuff manually until the systolic pressure is 30 to mmHg above your previous readings. Refer to sub-section 3.1.

2. The systolic pressure is above 210 mmHg and a measurement cannot be taken.

- Inflate the arm cuff manually until the systolic pressure is 30 to mmHg above your previous readings. Refer to sub-section 3.1.

**E3** appears

1. The arm cuff is inflated exceeding the maximum allowable pressure.

- Do not touch the arm cuff and/or bend the air tube while taking a measurement. If inflating the arm cuff manually, refer to the end of sub-section 3.1.

**E4** appears

1. You move or talk during a measurement. Vibrations disrupt a measurement.

- Remain still and do not talk during a measurement.

**E5** appears

 /  **3** appears

 **does not flash during a measurement**

1. The pulse rate is not detected correctly.

- Apply the arm cuff correctly, then take another measurement. Refer to sub-section 2.6. Remain still and sit correctly during a measurement. If the “ **3**” symbol continues to appear, we recommend you to consult with your physician.

**Er** appears

1. The monitor has malfunctioned.

- Press the [START/STOP] button again. If “Er” still appears, contact customer service. Refer to section 12.

**E**  
**rr** appears

1. The monitor cannot connect to a smart device or transmit data correctly.

- Follow the instructions shown in the “OMRON connect US/CAN” app. If the “Err” symbol still appears after checking the app, contact customer service. Refer to section 12.



**flashes**

1. The monitor is waiting for pairing with the smart device.
  - Refer to sub-section 4.1 for pairing your monitor with your smart device, or press [START/STOP] button to cancel pairing and turn your monitor off.



**flashes**

1. The monitor is ready to transfer your readings to the smart device.
  - Open the “OMRON connect US/CAN” app to transfer your readings.



**flashes**

1. There are more than 80 readings in memory to be transferred.
2. The date and time is not set.



**appears**

1. There are 100 readings in memory to be transferred.
  - Pair or transfer your readings to the “OMRON connect US/CAN” app so you can keep them in memory in the app, and this error symbol disappears.



**flashes**

1. Batteries are low.
  - Replacing all 4 batteries with new ones is recommended. Refer to sub-section 2.1.



**appears or the monitor is turned off unexpectedly during a measurement.**

1. Batteries are depleted.
  - Immediately replace all 4 batteries with new ones. Refer to sub-section 2.1.

**Nothing appears on the display of the monitor.**

1. Batteries are depleted.
  - Immediately replace all 4 batteries with new ones.
2. Battery polarities are not properly aligned.
  - Check the battery installation for proper placement. Refer to sub-section 2.1.



### **Readings appear too high or too low.**

- Blood pressure varies constantly. Many factors including stress, time of day, and/or how you apply the arm cuff, may affect your blood pressure. Review sub-sections 2.5 - 2.7 and section 3.

### **Any other communication issue occurs.**

- Follow the instructions shown in the smart device, or visit the "Support" section in the "OMRON connect US/CAN" app for further help. If the problem still persists, contact customer service. Refer to section 12.

### **Any other problems occur.**

- Press the [START/STOP] button to turn the monitor off, then press it again to take a measurement. If the problem continues, remove all batteries and wait for seconds. Then re-install batteries. If the problem still persists, contact customer service. Refer to section 12.

## **Maintenance**

### **Maintenance**

To protect your monitor from damage, follow the directions below:

- Changes or modifications not approved by the manufacturer will void the user warranty.

#### **Caution**

- **DO NOT disassemble or attempt to repair this monitor or other components. This may cause an inaccurate reading.**

### **Storage**

Store your monitor and other components in a clean, safe location.

#### **1. Remove the arm cuff from the monitor.**

#### **Caution**

To unplug the air plug, pull on the plastic air plug at the base of the tube, not the tube itself.

#### **2. Gently fold the air tube into the arm cuff.**

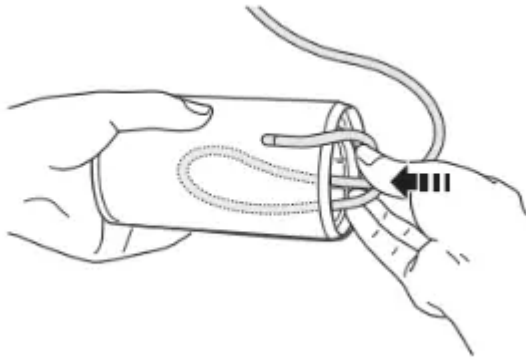

### Note

- Do not bend or crease the air tube excessively.

Do not store your monitor and other components:

- If your monitor and other components are wet.
- In locations exposed to extreme temperatures, humidity, direct sunlight, dust or corrosive vapors such as bleach.
- In locations exposed to vibrations or shocks.

### Cleaning

- Do not use any abrasive or volatile cleaners.
- Use a soft dry cloth or a soft cloth moistened with mild (neutral) detergent to clean your monitor and arm cuff and then wipe them with a dry cloth.
- Do not wash or immerse your monitor and arm cuff or other components in water.
- Do not use gasoline, thinners or similar solvents to clean your monitor and arm cuff or other components.

### Disposal

Dispose of your monitor, other components and optional accessories according to applicable local regulations. Unlawful disposal may cause environmental pollution.

### Limited Warranty

Your BP7450 Blood Pressure Monitor, excluding the arm cuff, AC adapter and batteries is warranted to be free from defects in materials and workmanship appearing within 5 years from the date of purchase, when used in accordance with the instructions provided with the monitor. The arm cuff and AC adapter are warranted to be free from defects in materials and workmanship appearing within 1 year from the date of purchase when the monitor is used in accordance with the instructions provided with the monitor. The above warranty extends only to the original retail purchaser. We will, at our option, replace without charge any monitor,

arm cuff or AC adapter covered by the above warranty. Replacement is our only responsibility and your only remedy under the above warranty. To obtain warranty service contact Customer Service by calling 1- for the address of the inspection center and the return shipping and handling fee. Enclose the original printed receipt. Include a letter, with your name, address, phone number, and description of the specific problem. Pack the product carefully to prevent damage in transit. Because of possible loss in transit, we recommend insuring the product with return receipt requested.

**THE FOREGOING IS THE SOLE WARRANTY PROVIDED BY OMRON IN CONNECTION WITH THIS PRODUCT, AND OMRON HEREBY DISCLAIMS ANY OTHER WARRANTIES, EXPRESS OR IMPLIED, INCLUDING IMPLIED WARRANTIES OF MERCHANTABILITY AND FITNESS FOR A PARTICULAR PURPOSE. IMPLIED WARRANTIES AND OTHER TERMS THAT MAY BE IMPOSED BY LAW, IF ANY, ARE LIMITED IN DURATION TO THE PERIOD OF THE ABOVE EXPRESS WARRANTY.**

**OMRON SHALL NOT BE LIABLE FOR LOSS OF USE OR ANY OTHER SPECIAL, INCIDENTAL, CONSEQUENTIAL OR INDIRECT COSTS, EXPENSES OR DAMAGES.**

This warranty provides you with specific legal rights, and you may have other rights that vary by jurisdiction. Because of special local requirements, some of the above limitations and exclusions may not apply to you.

#### **Warning**

This content is compiled from multiple sources and is provided for reference purposes only. It may not be complete or fully applicable to all situations. If you are unable to resolve your issue, please contact the product manufacturer or an authorized service provider for official support.