

Product Diagram

1.1 Robot

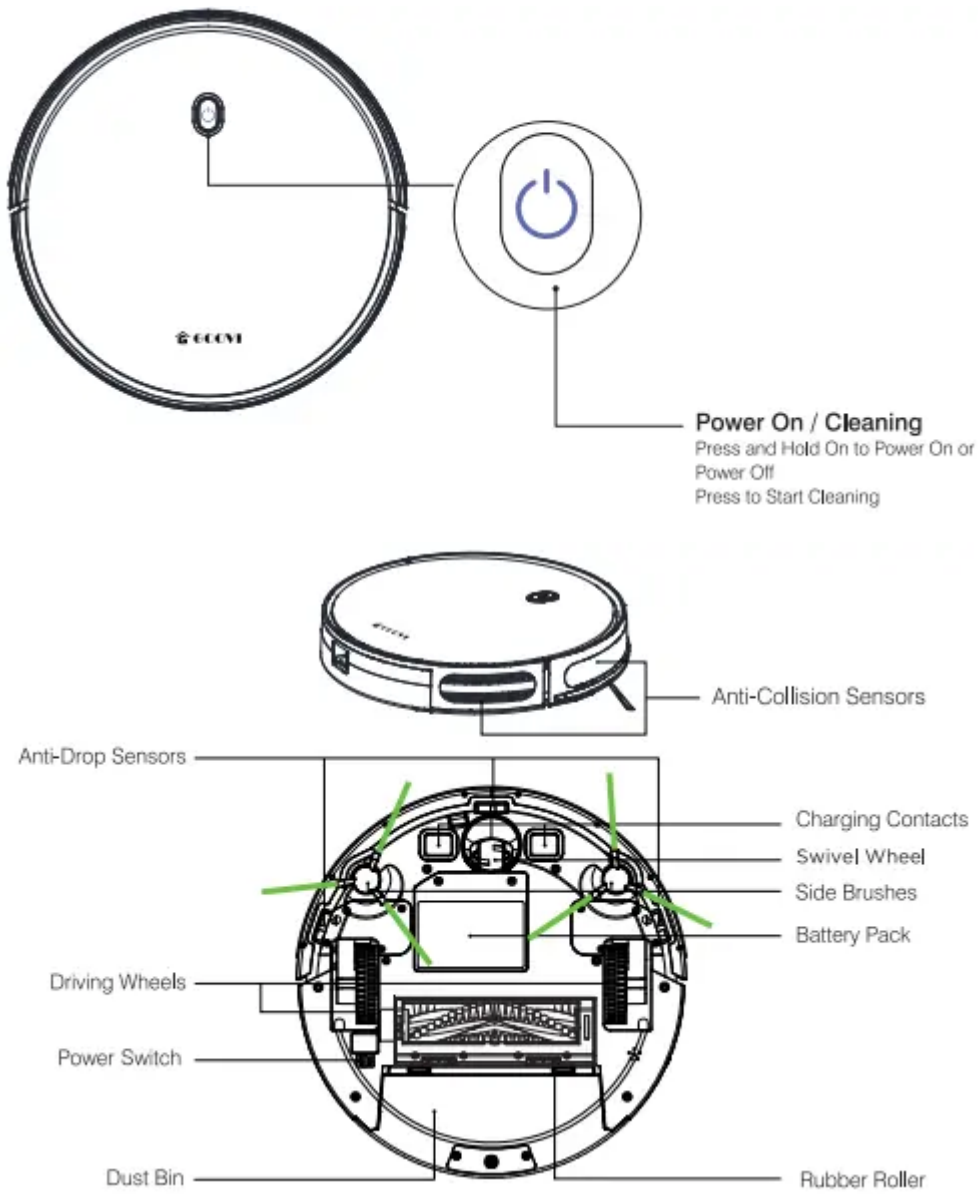

1.2 Accessories



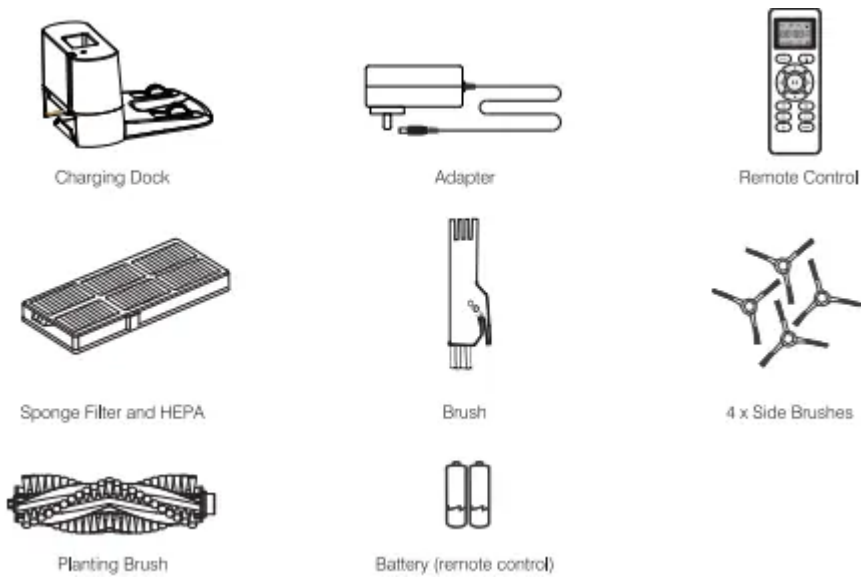

1.3 Charging Dock

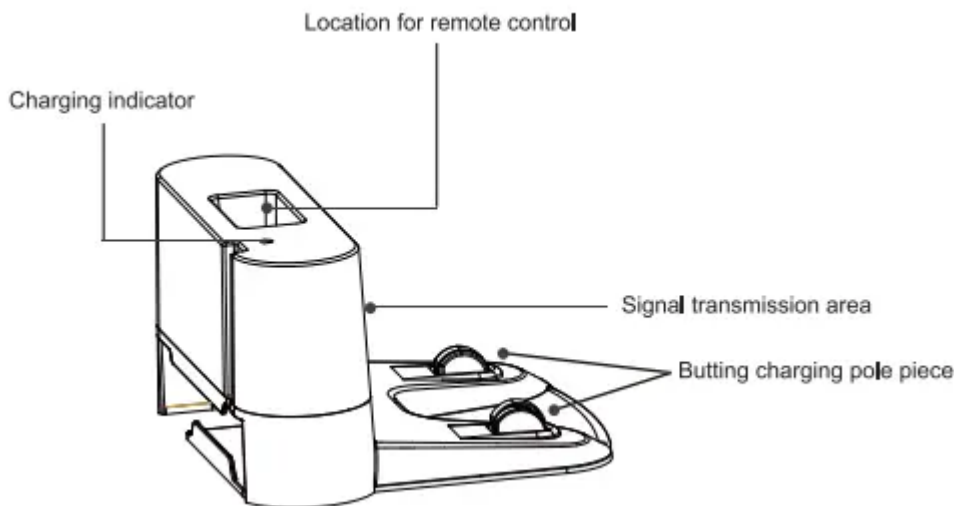

1.4 Remote Control

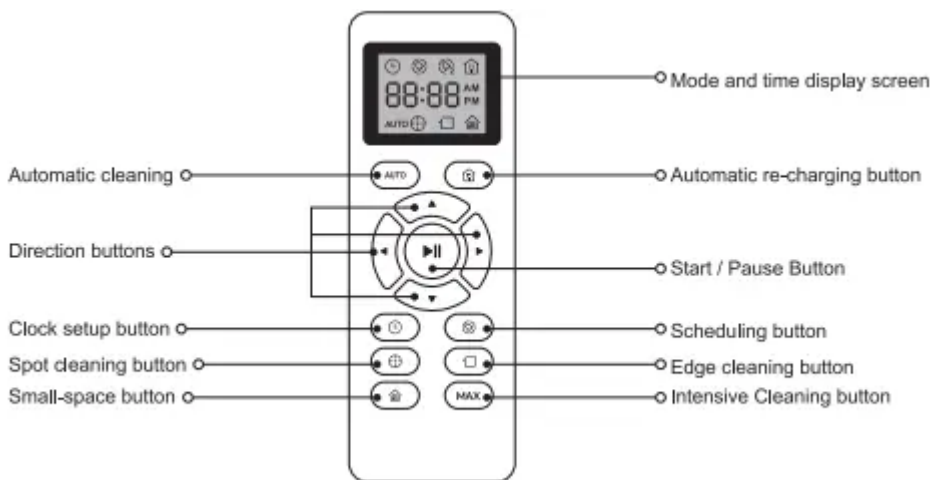

Operating and Programming

2.1 Notes Before Cleaning

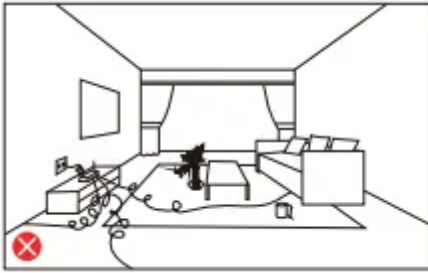

Before using Robot, pick up objects like clothing, loose papers, pull cords for blinds or curtains, power cords, and any fragile objects. If the Robot passes over a power cord and drags it, there is a chance an object could be pulled off a table or shelf.

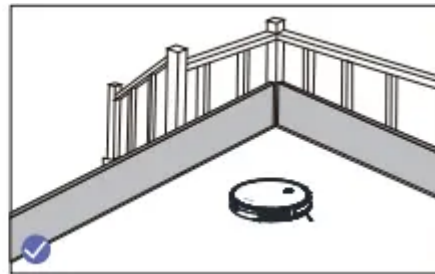
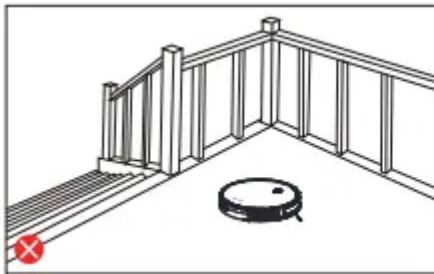

If the room to be cleaned contains a balcony, a physical barrier should be used to prevent access to the balcony and ensure safe operation.

2.2 Quick Start

1. Plug in the Charging Dock, and take the rest wire into the trunking at The bottom of Charging Dock.

Note: Didn't put the rest wire into the trunking may stuck the Robot while Charging or Cleaning.

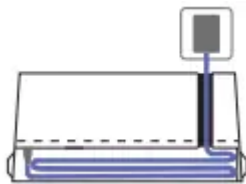

2. Charging Dock Position

Place the charging Dock against the wall & make sure the place is open & uncluttered area leaving at least

- 2 meters (6.5 feet) in front of the charging Dock
- 1 meters (2.3 feet) on both sides of the charging dock.

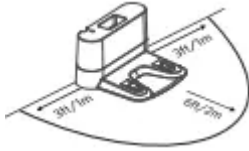

3. Install Side Brushes

Attach side brushes to the bottom of By pressing a brush into each slot with the matching color until it clicks.





4. Activate the Robot

Place onto the Charging Dock, making sure the metal charging contacts on the charging Dock match up with those underneath the robot.

If successful you will hear a series of tones, once the  Power button illuminates is ready for use.



5. Start Cleaning Cycle

- Press  the power button Once to wake up the robot.
- Press  the power button again to start a cleaning cycle

(or press the  button on Remote control).

If its battery gets low before finishing a cleaning cycle, robot Returns to the Charging Dock to recharge.

If the Charging Dock is inaccessible, Robot will not be able to recharge, please place the robot manually on.

Charging Dock for charging. (Refer Activate the Robot).

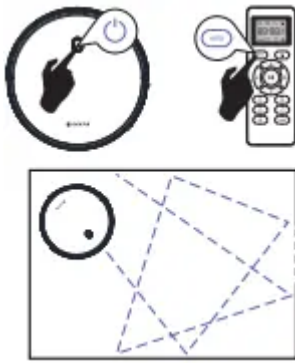

6. Pause

- To pause the robot during a cleaning cycle press the ⏸ button or press the ▶|| button on Remote control.
- To resume the cleaning cycle, press ⏸ button again.
- To send robot back to The Charging Dock, press 🏠 button.

Note: The actions listed above can also be managed from the Remote control.



7. Power OFF

- To end the cleaning cycle and put robot in standby mode, Press and hold indicators turn off.



2.3 How Cleans your home

F007C is designed to Intelligently navigate and clean an entire level of your home, a multifunctional function robot with cleaning Sweeping, Vacuuming, Wet/Dry mopping for your home.

1. Auto Cleaning

- At the start of a cleaning cycle, will map out your home and cleaning them efficiently.
- At various times throughout the cleaning cycle, touches up around the edges of the room, as well as chair legs and other furniture.
- Once finishes its cleaning cycle, returns to the Charging Dock recharge.

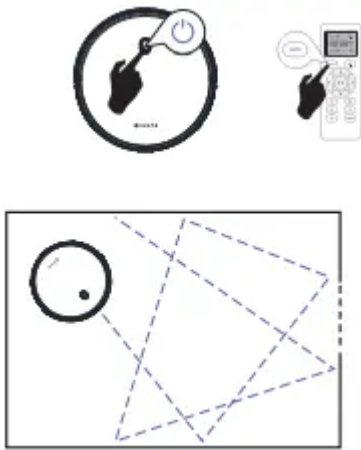

2. Spot Cleaning

When you select Spot Cleaning, robot intensely cleans a localized area by spiraling outward about 3 feet(1 meter) in diameter and then spiraling inward to where it started. When Spot Cleaning, Robot boosts its vacuum power to provide the best cleaning possible where you need it. To use Spot Cleaning, place robot on top of the localized debris and press () (Spot) on the Remote control.

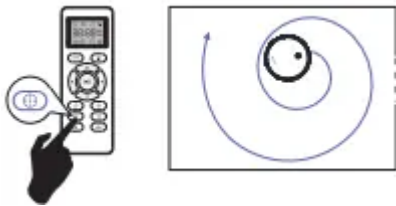

3. Max Vacuuming Cleaning

Robot increases its vacuum power to provide a deeper clean when press the  button on Remote control, Max Vacuuming Cleaning if Off by default.

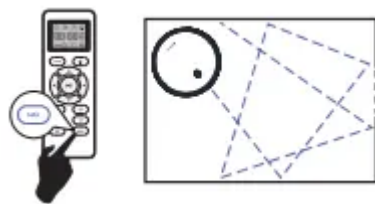

4. Edge Cleaning

After robot finishes cleaning the open areas of your floor, it uses Edge Clean to ensure that it has cleaned along walls and around furniture Legs, If you prefer a quicker edge cleaning, press the  button on Remote Control.

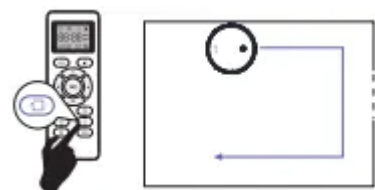







2.4 Cleaning Schedule

Robot has cleaning schedule settings which allow you to customize when Robot cleans your home. These settings are available only through the Remote Control.

Note: Please make sure the Remote Control near by the Robot while setting the Clock or Schedule.







1. Set the Remote Control's Clock



- Press  button on Remote Control, and then the hour section begins to flash in the clock display setting window.
- Press  or  button to select the desired figures. Press the  or  button to select the minute or hour section.
- And then press the  button, the Robot will "BEEP" when the clock setting completed.

2. Setting Cleaning Schedule



- Press  button on Remote Control, and then the hour section begins to Hash in the Cleaning Schedule display setting window
- Press  or  button to select the desired figures. Press the  or  button to select the minute or hour section.
- And then press the  button, the Robot will "BEEP" when the Cleaning Schedule setting completed.

3. Cancel the Cleaning Schedule

Press and hold  button approximately 4 seconds on Remote Control, the Robot will "BEEP" twice when the Cleaning Schedule process cancel completed.





3. Regular Robot Care

To keep robot running at peak performance, perform the following care procedures. If you notice robot picking up less debris from your floor, then empty the bin, clean the filter, and clean the extractors.

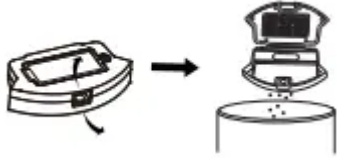
3.1 Emptying Robot's Bin

1. Press bin release button to remove bin	2. Open bin door empty bin.
	

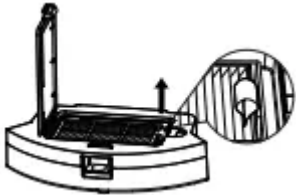
3.2 Cleaning Robot's Filter

1. Remove filter grasping the white tab.	2. Shake off debris by tapping the filter against your trash container.
	

3.3 Cleaning Robot's Rolling Brush, Side Brush, Swivel Wheel and Sensors.

1. Take out the rolling brush, clean the vacuuming aisle by a cloth.



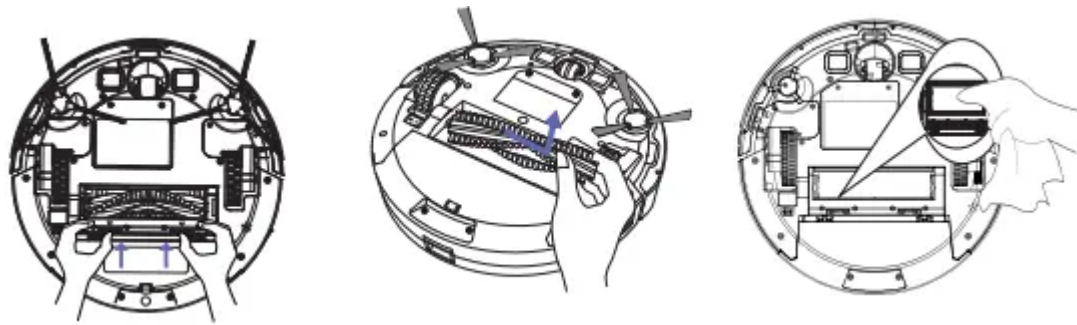

2. Clean the rolling brush. Cut down the hair winded in the rolling brush with the provided cleaning tool's knife.

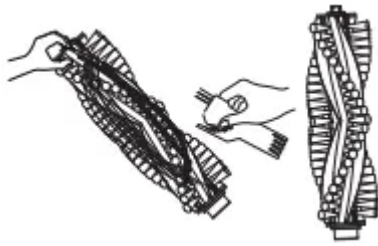

3. Remove the side brush,use a cloth to remove the dust from the brush.



3.5 Battery and Charging / Information

Lithium Ion Battery

Important: Lithium ion batteries and products that contain lithium ion batteries are subject to stringent transportation regulations. If you need to ship this product (with the battery included) for service, travel or any other reason, you MUST comply with the following shipping instructions:

- Remove the lithium ion battery from the product
- Place a Piece of tape over the battery's metal charging contacts
- Reinstall the battery (with the tape on it) in the product and secure the battery door
- Package the product in its original packaging or in your own packaging that prevents any movement during transportation
- Ship via ground transportation only (no air shipping)

Battery Charging

To extend battery life, always keep robot charged on the home base when not use.

Battery Storage

If storing robot off of the Charging Dock, remove the battery first. Then store robot and the battery in a cool, dry place.

Battery Removal

Follow these Instructions to remove and reinstall robot's battery:

1. Unscrew the two screws on the battery door, then remove the door and battery.

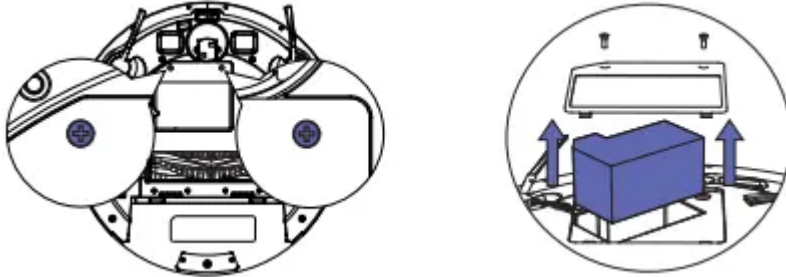

2. Reinstall the battery with the battery label and tabs facing up.

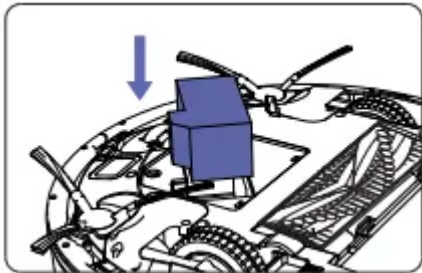

3. Reinstall the battery door and the two screws. Take care not to pinch the side brush in the battery door when re-installing the battery.

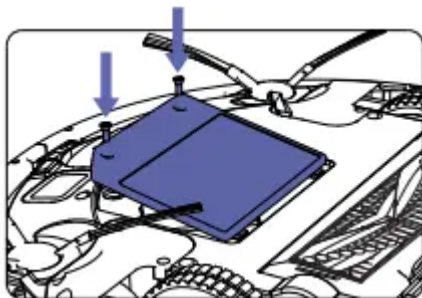

Troubleshooting

Robot will tell you something is wrong with a two-tone distress sound followed by a spoken message. The indicator will also blink or lit red. Refer to the chart as below to resolve Robot's problem. If the e problem is not resolved, please contact our COST FREE customer service team for more assistance.

Rebooting Instructions

For some errors, rebooting Robot may resolve the problem. To reboot Robot, press the power button on the bottom on Robot, you will hear an audible tone signifying a successful reboot.

Beeps and red light flashing

Beeps	Error	Solution
1	No dust or water tank installed	Insert the dust or water tank in the robot.
2	Bumper error	Check the bumper and remove any object that could be blocking it.
3	Free-fall sensors error	Clean the free-fall sensors.
4	Other error	Contact the Technical Support Service of Cecotec.

Beeps and steady red light

Beeps	Error	Solution
1	Driving wheel error	Manually spin the wheel and remove any object that could be blocking it
2	Side brushes error	Unblock or untangle the side brushes and clean them.
3	Motor error	Empty the dust tank and clean the suction channel.

Specifications

Classification	Item	Specifications
Structural Class	Diameter	325mm
	Height	70mm
	Net Weight	2.6kg
Electronic Class	Voltage	14.4V
	Battery Capacity	
Cleaning Parameters	Dustbin Volume	0.5L
	Charging Type	Automatic Charging
	Cleaning Mode	Automatic Cleaning Spot Cleaning Edge Cleaning Appointment Cleaning
	Description of Light Display	Red Light: Failure warning
	One-time Charging Time	About 300 Minutes
	One-time Cleaning Time	About 120 Minutes
Host Button Type		Mechanical Button

Notes: This product shall be stores in the ambient temperature range from -20°C to 60°C.

Warning

This content is compiled from multiple sources and is provided for reference purposes only. It may not be complete or fully applicable to all situations. If you are unable to resolve your issue, please contact the product manufacturer or an authorized service provider for official support.