

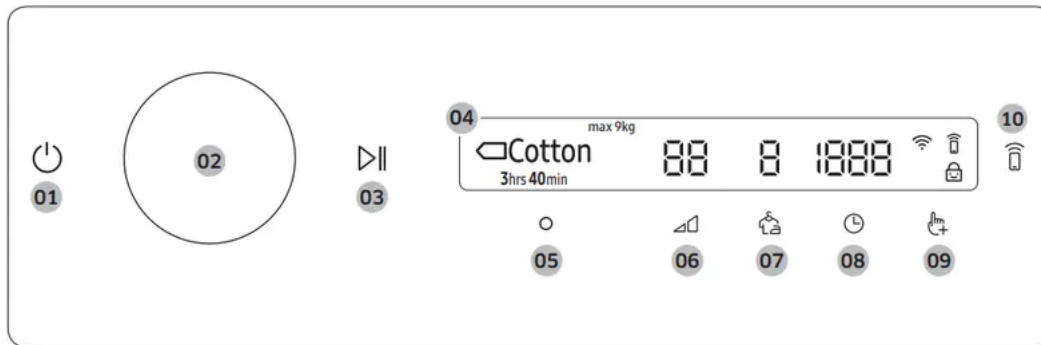













## Operations

### Control panel









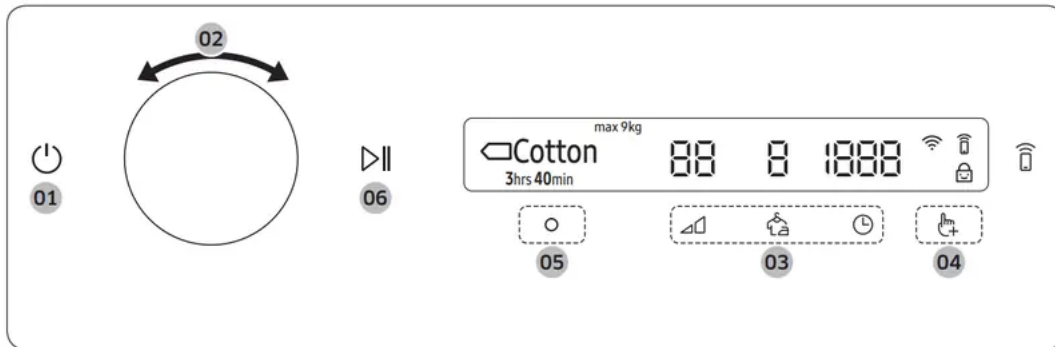

<p><b>01</b> Power </p>	<p>Tap to turn the dryer on or off.</p> <ul style="list-style-type: none"> <li>If you do not manipulate the control panel for 10 minutes after the dryer is turned on, the dryer automatically turns off.</li> <li>The dryer automatically turns off when the drying completes.</li> </ul> <p><b>CAUTION</b></p> <p>Do not tap  to turn the dryer off while the drying is in progress. Tap and hold  to pause the cycle first, and then tap  to turn the dryer off.</p>
<p><b>02</b> Navigation dial</p>	<p>Turn the <b>Navigation dial</b> left or right to navigate through cycles and functions. When you turn the <b>Navigation dial</b>, the display shows your selection (such as cycle, additional functions, and system functions).</p>
<p><b>03</b> Start/Pause </p>	<p>Tap and hold to start or pause an operation.</p>
<p><b>04</b> Display</p>	<p>The display shows the current cycle, estimated time remaining, cycle options, and other useful or alert messages.</p>
<p><b>05</b> OK </p>	<p>Tap to confirm your selection of function or setting.</p>
<p><b>06</b> Dry Level </p>	<p>Tap to change the dry level for the selected cycle. You can select from level <b>1</b> to <b>3</b>, but available level depends on the selected cycle.</p> <ul style="list-style-type: none"> <li><b>3</b>: Suitable for large and thick items.</li> <li><b>2</b>: Standard drying level.</li> <li><b>1</b>: Gently dries items to protect fabric. Suitable for delicate items or items you want to naturally dry (by hanging or laying flat on drying rack) while they are damp.</li> </ul>
<p><b>07</b> Wrinkle Prevent </p>	<p>Tap to turn the Wrinkle Prevent function on or off. When the function is on, the dryer rotates the drum intermittently after completing the dry cycle to prevent wrinkles.</p>
<p><b>08</b> Time </p>	<p>Tap to select the cycle time for Time Dry, Warm Air, or Cool Air. You can set the drying time between 20 minutes and 240 minutes. Available drying time depend on the selected cycle.</p>
<p><b>09</b> Additional Functions </p>	<ul style="list-style-type: none"> <li>Tap to enter the additional functions menu.</li> <li>Tap and hold for 3 seconds to enter the system functions menu.</li> </ul>
<p><b>10</b> Smart Control </p>	<p>Tap to activate or deactivate the Smart Control function.</p> <ul style="list-style-type: none"> <li>When the Smart Control function is activated, you can control your dryer remotely using the SmartThings app in your smartphone.</li> </ul>

## Icon description

	Wi-Fi	This icon indicates that the dryer is connected to Wi-Fi.
	Smart Control	This icon indicates that Smart Control is on. For more information on "Smart Control", see page 38.
	Child Lock	This icon indicates that Child Lock is on. For more information on "Child Lock", see page 35.

## Operating a cycle





1. Tap  to turn on the dryer.
2. Turn the Navigation dial to select the cycle you want. For more information on "Cycle overview", see page 31.
3. Tap , , or  to change the default cycle settings.
4. Tap , and then turn the Navigation dial to select additional function. For more information on "Additional functions", see page 34.
5. Tap  to change the settings for selected additional function. Not all cycles have additional functions available.
6. Tap and hold  to start operation. Once you set the cycle you want, the screen displays a brief cycle description, maximum laundry load, and cycle time. You can also check the cycle progress, remaining cycle time, and information codes.

## Additional functions

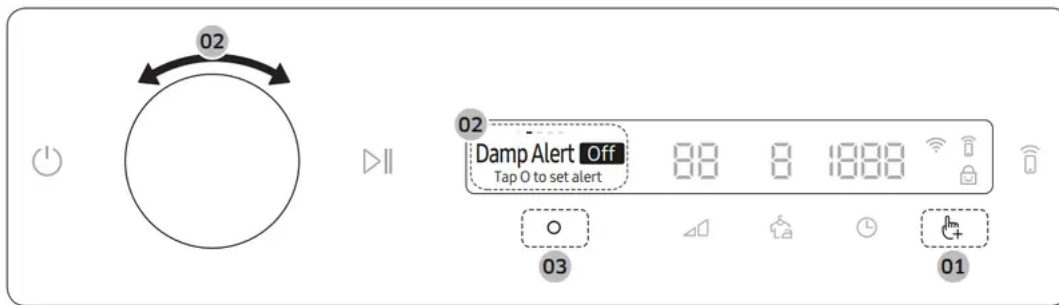
### Using Additional Functions





1. Tap .
2. Turn the Navigation dial to select the desired additional function.
3. Tap  to change the selected function's settings or start the function.

### Damp Alert



This function alerts you when shirts and other items that require ironing are dry enough to be suitable for ironing.

1. Select a cycle and change the cycle settings as necessary.

- This function is available for  Cotton, Synthetics, Mixed Load, and Silent Dry with the Dry Level set to 2 or 3.



2. Tap .
3. Turn the Navigation dial to select Damp Alert, and then tap .
4. Tap and hold .

### Alarm during drying:

1. Tap and hold  to pause the cycle.
2. Open the door and take out the items you want to iron.
3. Close the door, and then tap and hold  to dry the remaining items.

### My Cycles

Add or remove cycles to create a personal cycle list.

1. Tap .
2. Turn the Navigation dial to select My Cycles, and then tap .
  - You can only edit a cycle to create a personal cycle when the dryer is not operating.

3. Turn the Navigation dial to select a desired cycle.

4. Tap  to add or remove the selected cycle. - Addition and removal of a cycle is saved automatically.

5. Once you finish creating My Cycles, tap  to return to the cycles screen.

## Delay End

You can set the dryer to finish your drying automatically at a later time by choosing a delay of between 1 to 24 hours (in 1 hour increments). The hour displayed indicates the time the dry will finish.

1. Select a cycle and change the cycle settings as necessary.

2. Tap .

3. Turn the Navigation dial to select Delay End, and then tap .

4. Turn the Navigation dial to select the desired time, and then tap .

5. Tap and hold .

- To cancel Delay End, tap  restart the dryer.

## Child Lock

To prevent children or infants from accidentally starting or setting the dryer, Child Lock locks all

buttons except for  and .

1. Close the door.

2. Tap .

3. Turn the Navigation dial to select Child Lock, and then tap .

4. Tap  to select On or Off .

- The Child Lock  icon turns on when the function is on.

- You cannot turn on Child Lock with the door open. If you get the "Door is open" message on the display while you try to turn on Child Lock, close the door and try again.

## Special features

### Smart Control

You can connect to the SmartThings app and control your dryer remotely.

### **Connecting your dryer**

- Download and open the SmartThings app on your mobile device

- Tap and hold  to turn on the dryer.

- Tap and hold  on the dryer.

- a. The dryer enters AP mode and connects to your mobile device.

- b. Tap  to authenticate your dryer on your mobile device.



- c. Once the authentication process is complete, your dryer is successfully connected to the app. Use various features available in the SmartThings app.

### **Stay Connect**

Set up the Stay Connect function in your SmartThings app. Your dryer stays connected to the app so you can use the dryer when you are away from home.

1. If you turn on the Stay Connect function on the SmartThings app, the dryer will stay in standby power saving mode after completing a cycle.

- The Stay Connect function will remain active for up to 24 hour if the door remains closed.

2. When the Stay Connect function is active, the Smart Control  and Wi-Fi  turn on your dryer display.

3. Conveniently control your dryer using the SmartThings app

### **SmartThings**

#### **Wi-Fi connection**

On your smartphone, go to Settings and turn on the wireless connection and select an AP (Access Point).

- This appliance supports the Wi-Fi 2.4 GHz protocols

#### **Download**

On an app market (Google Play Store, Apple App Store, Samsung Galaxy Apps), find the SmartThings app with a search term of "SmartThings". Download and install the app on your device.

#### **Log in**

You must first log into SmartThings with your Samsung account. To create a new Samsung account, follow the instructions on the app. You don't need a separate app to create your account.

### ***To register your appliance to SmartThings***

1. Make sure your smartphone is connected to a wireless network. If not, go to Settings and turn on the wireless connection and select an AP (Access Point).
2. Open SmartThings on your smartphone.
3. If a message of "A new device is found.", select Add.
4. If no message appears, select + and select your appliance in a list of devices available. If your appliance is not listed, select Device Type > Specific Device Model, and then add your appliance manually.
5. Register your appliance to the SmartThings app as follows.
  - a. Add your appliance to SmartThings. Make sure your appliance is connected to SmartThings.
  - b. When registration is complete, your appliance appears on your smartphone.

## **Maintenance**

### **Emptying the water tank**

Empty the water tank after each use to prevent leaks.

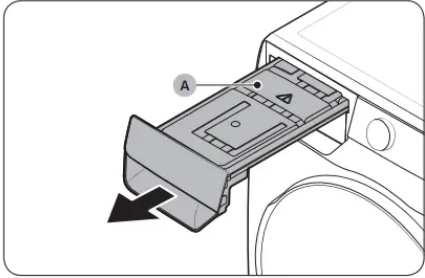
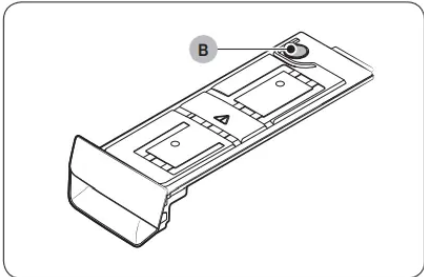
	<p>1. Remove the water tank (A) from the dryer.</p> <ul style="list-style-type: none"> <li>- Pull the water tank handle with one hand until the tank is halfway out.</li> <li>- Once the water tank is halfway out, support the bottom of the tank with the other hand and pull it slowly with both hands.</li> </ul>
	<p>2. Empty the water through the drain hole (B), and then clean inside the water tank.</p> <ul style="list-style-type: none"> <li>- Mix some neutral detergent in lukewarm water. Fill the water tank with the mixture through the drain hole (B) and leave it for 30 minutes. Then, rinse the tank with clean water and completely dry it.</li> </ul> <p>3. Place the water tank back into place.</p>

## Cleaning

### Exterior

Clean with a soft, damp cloth. Do not use abrasive cleaners. Avoid using or placing sharp or heavy objects near/on the dryer. Keep detergent and laundry supplies on the pedestal (sold separately) or in a separate storage container.

### Control panel

Clean with a soft, damp cloth. Do not use abrasive cleaners. Do not spray cleaners directly on the panel. Immediately wipe up any spills or liquids from the control panel.

### Drum

Clean with a damp cloth with a mild, non-abrasive cleaner suitable for stainless steel.

Wipe remaining residue with a clean, dry cloth.

### Door

Foreign substances can contaminate or build up on the inside of the door. Clean the inside of the door using a soft piece of cloth or brush.

### Lint filter

Clean the lint filter after each use.

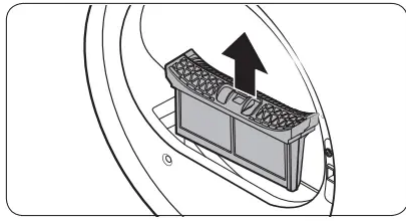

1. Open the dryer door, grab the top of the lint filter, and pull to remove the filter.

- Do not detach the rubber sealing after removing the filter.

	<p>2. Open the outer filter and remove the inner filter (A)</p>
	<p>3. Spread open the outer filter and the inner filter.</p> <p>4. Remove the lint from both filters, and then clean the filters with the cleaning brush.</p>
	<p>NOTE: To clean the filters thoroughly, clean the filters in running water, and then dry them completely</p>
	<p>5. Put the inner filter into the outer filter, and then reinsert the lint filter into the original position.</p>

## Heat exchanger

When it is time to clean the heat exchanger, the dryer will alert you by displaying the “Clean heat exchanger” message.

A dirty heat exchanger will hinder the product’s performance and should be cleaned regularly.

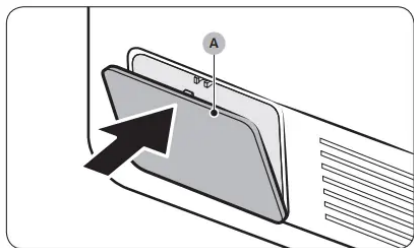

1. Gently press the top part of the outer cover (A) to open.

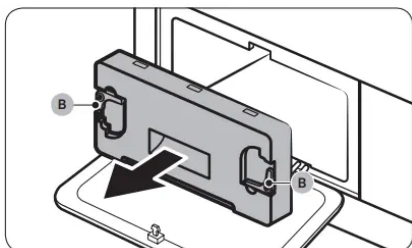

2. Unlock the inner cover fixers (B), and then pull the inner cover to remove.

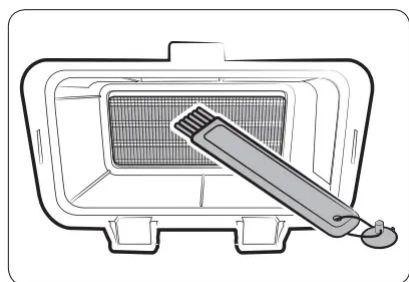

3. Clean the dust on the heat exchanger using the provided brush.

- After cleaning with the brush, wipe off the remaining dust using a smooth, damp cloth.

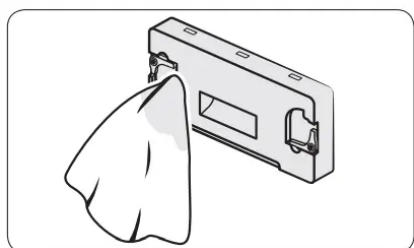

4. Clean the inner cover with a smooth, damp cloth.

- There may be moisture and/or foreign substances around the inner cover.

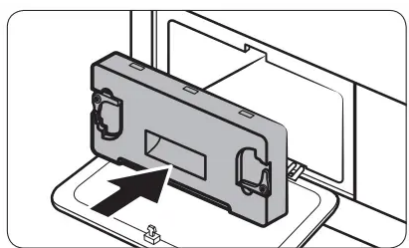

5. Reinsert the inner cover to its original position, and then lock the fixers.

6. Close the heat exchanger's outer cover.

# Troubleshooting

## Checkpoints

If you encounter a problem with the dryer, first check the table below and try the suggestions.



Problem	Action
Dryer does not start.	<ul style="list-style-type: none"> <li>• Make sure the dryer is plugged in.</li> <li>• Make sure the door is properly closed.</li> <li>• Check the fuse or reset the circuit breaker.</li> <li>• If you opened the door during a cycle, tap and hold  again.</li> <li>• Clean the filter.</li> <li>• Make sure Child Lock is not activated</li> </ul>
The dryer does not warm up.	<ul style="list-style-type: none"> <li>• Check the fuse or reset the circuit breaker.</li> <li>• Check the lint filter and the heat exchanger. Clean them if necessary.</li> <li>• The dryer may be in the cooling down process of the cycle.</li> </ul>
Items are not dried.	<p>Check all of the above. Additionally:</p> <ul style="list-style-type: none"> <li>• Do not overload the dryer. If the dryer is overloaded, it could take longer for items to dry.</li> <li>• Dry heavy fabrics separately from light fabrics.</li> </ul> <p>The item(s) are too small and may not getting enough spinning inside the drum.</p> <ul style="list-style-type: none"> <li>• Clean the filter.</li> <li>• Clean the heat exchanger.</li> <li>• If a drain hose is connected, make sure water is draining properly.</li> </ul>
The dryer is too loud.	<ul style="list-style-type: none"> <li>• Look for coins, loose buttons, nails, and other objects and remove them immediately.</li> <li>• Check the lint filter. Remove any items stuck inside the lint filter.</li> <li>• Make sure the dryer is level and standing firmly on the floor.</li> <li>• The dryer may hum due to air moving through the drum and fan. This is normal.</li> </ul>

<p>Items are not dried evenly.</p>	<ul style="list-style-type: none"> <li>• Seams, pockets, and other parts of clothing are harder to dry than others. This is normal.</li> <li>• Sort heavy and light items separately</li> </ul>
<p>There is a smell coming from the dryer.</p>	<ul style="list-style-type: none"> <li>• The smell of paint, varnish, cleaning agents, and other household items could have circulated in the air and entered the dryer. If you notice such a smell, ventilate completely before using the dryer.</li> <li>• If drying in an enclosed area, the dryer could cause the ambient temperature to rise. Accordingly, make sure to open a window and ventilate the area.</li> <li>• Do not attempt to dry wet items after leaving them in the washing machine or dryer for a long time.</li> </ul>
<p>The dryer turns off before the items are dry</p>	<ul style="list-style-type: none"> <li>• The load is too small. Throw in few additional items like towels and try drying again.</li> </ul>
<p>The clothes have lint on them.</p>	<ul style="list-style-type: none"> <li>• Always make sure the lint filter is clean before putting items into the dryer. When drying items that generate a large amount of lint, you may need to clean the lint filter in the middle of a cycle.</li> <li>• Some fabrics (such as white towels) causes more lint and should be dried separately from fabrics that lint attaches easily (such as black linen pants).</li> <li>• Check the inside of the pockets to make sure they are empty before drying.</li> </ul>
<p>The ambient temperature around the dryer rises or there is a damp, soggy smell.</p>	<ul style="list-style-type: none"> <li>• Heat pump dryers circulate ambient air inside and outside the dryer during the drying process to cool the system. Using the dryer in a poorly ventilated area may, depending on the operating environment, raise the ambient humidity level and/or cause a damp, soggy smell to develop. Ensure proper ventilation when using the dryer.</li> </ul>
<p>Water is not draining.</p>	<ul style="list-style-type: none"> <li>• Check the draining hose for twists and kinks.</li> </ul> <p style="text-align: center;">Straighten out the hose if it is twisted or kinked and securely connect it to the drain on the floor.</p>



- Check to see if the draining hose is frozen.

If the hose is frozen, submerge it in warm water to allow the water inside the hose to melt and drain out. Reconnect the hose and check for proper draining.

If a problem persists, contact a local Samsung service center.

### **Information codes**

If the dryer fails to operate, you may see an information code on the screen. Check the table below and try the suggestions.

<b>Information code</b>	<b>Meaning</b>	<b>Action</b>
Door is open	Dryer operation with the door open	<ul style="list-style-type: none"> <li>• Close the door and start again.</li> <li>• If this continues, call for service.</li> <li>• Check if Child Lock is on. If Child Lock is on, you may get this message when you open the door even though the dryer is not operating.</li> </ul>
Open door & check inside (Child Lock on)	Child Lock is on. Open the door and check inside the drum.	<ul style="list-style-type: none"> <li>• If Child Lock is on, turn off Child Lock or the power.</li> </ul>
Check filter	Lint filter problem	<ul style="list-style-type: none"> <li>• Check the lint filter assembly.</li> <li>• If this continues, call for service.</li> </ul>
Check inner cover of heat exchanger	Internal heat exchanger cover problem	<ul style="list-style-type: none"> <li>• Check the internal heat exchanger cover assembly.</li> <li>• If this continues, call for service.</li> </ul>
Check drainage / Empty the tank	Draining malfunction Draining pump malfunction Frozen draining hose Water tank full	<ul style="list-style-type: none"> <li>• Make sure the draining hose is not bent or damaged.</li> <li>• If the hose is frozen, wrap the hose with a towel soaked in warm water for approximately ten minutes to thaw the hose.</li> <li>• Empty the water tank, turn on the dryer, and start again.</li> <li>• If this continues, call for service.</li> </ul>
tC	Air temperature sensor problem	<ul style="list-style-type: none"> <li>• Clean the lint filter or the heat exchanger.</li> <li>• If this continues, call for service.</li> </ul>
tC5		<ul style="list-style-type: none"> <li>• Wait two to three minutes.</li> </ul>

	Compressor temperature sensor problem	<ul style="list-style-type: none"> <li>• Turn the power back on and start again.</li> </ul>
3C	Check the motor for operation.	<ul style="list-style-type: none"> <li>• Try restarting the cycle.</li> <li>• If this continues, call for service.</li> </ul>
AC6	Check communications between the main and the inverter PBAs.	<ul style="list-style-type: none"> <li>• Try restarting the cycle.</li> <li>• If this continues, call for service.</li> </ul>
HC	Compressor overheating	<ul style="list-style-type: none"> <li>• Call for service.</li> </ul>

If any information code keeps appearing on the screen, contact a local Samsung service center.

## Specification

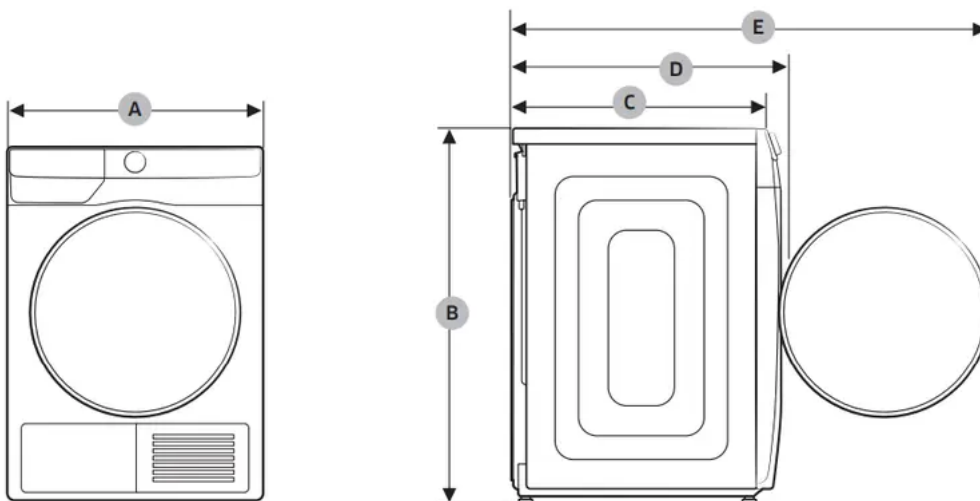

TYPE		FRONT LOADING DRYER	
MODEL NAME		DV9*T7*****	DV9*T8*****
		DV8*T7*****	
		DV9*T6*****	
		DV8*T6*****	
		DV9*T5*****	
		DV8*T5*****	
DIMENSIONS	A	600 mm	600 mm
	B	850 mm	850 mm
	C	600 mm	600 mm
	D	650 mm	660 mm
	E	1100 mm	1110 mm
WEIGHT		50.0 kg	54.0 kg
ELECTRICAL REQUIREMENTS	AC 220-240 V / 50 Hz	780-800 W	
ALLOWABLE TEMPERATURE		5-35 °C	

### Warning

This content is compiled from multiple sources and is provided for reference purposes only. It may not be complete or fully applicable to all situations. If you are unable to resolve your issue, please contact the product manufacturer or an authorized service provider for official support.