

Product Instruction

What's in the box

1. Robot Vacuum Cleaner	3. Remote Control	5. Side Brushes X 4	7. Clean Brush
2. Charging Base	4. Power Adapter	6. HEPA X 2	8. Instruction Manual



1



2



3



4



5

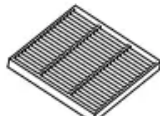

6



7



8

Assembly Name

► Master

Top View

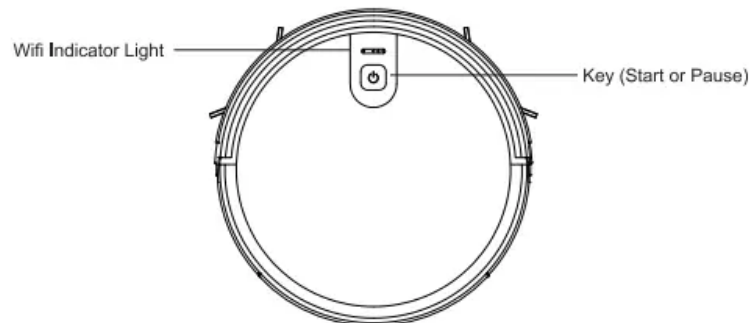

Bottom View

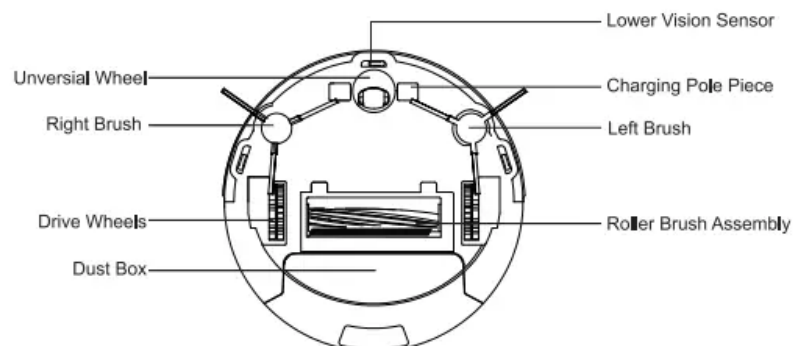

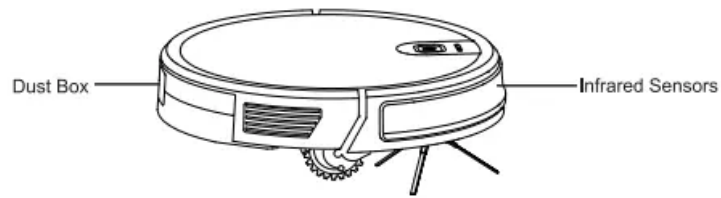

► Dust box

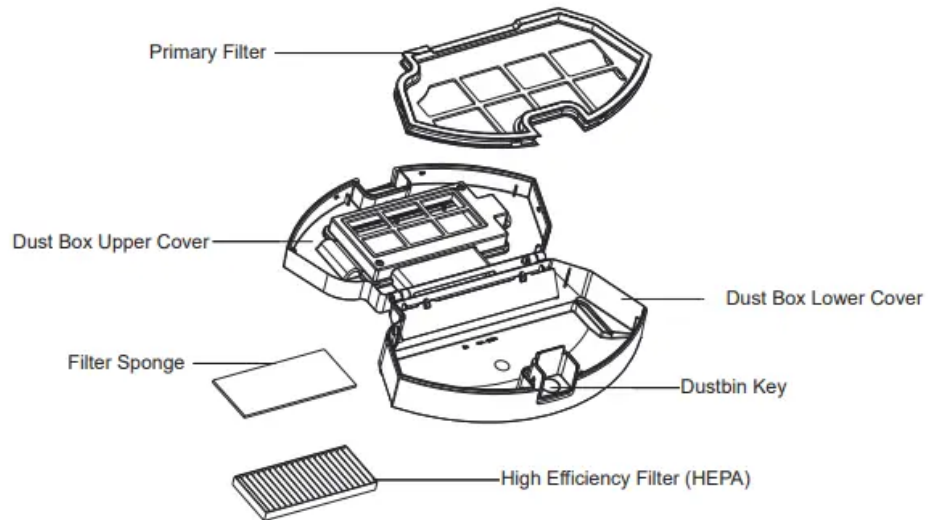

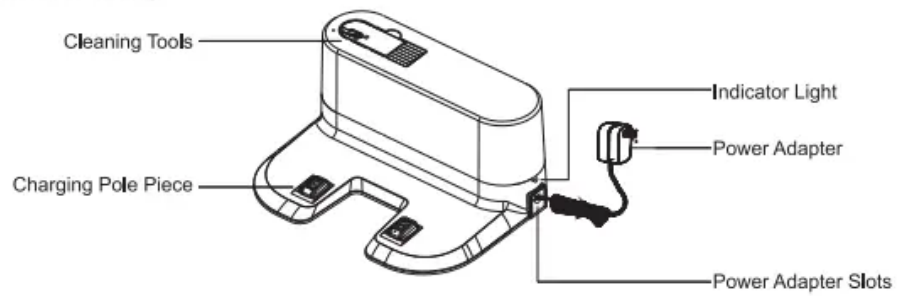

► Changing Stand Assembly

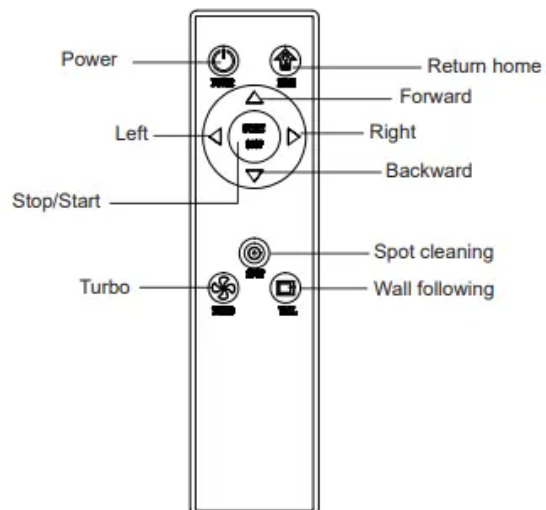

► Remote Control

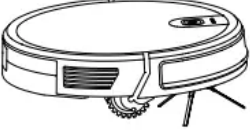

	Product Model	A710
	Input	DC 14.4V
	Power	30W
	Battery Capacity	DC 14.4V Li-ion 2500mAh
	Dust Box Capacity	0.6L
	Cleaning Time	120 min
	Charging Time	300 min
	Battery	DC 3V(AAA)
	Remote Control Method	Infrared
	Emitting and Receiving Distance	≤5M
	Input	100-240V/50-60Hz
	Output	19V/0.6A

Install 2 AAA batteries before using the remote control for the first time. Make sure the positive and negative ends are facing the correct polarity direction as marked in the battery compartment.

Attention

Considerations

Please refer to the following guidelines to check the cleaning area before the cleaner works.

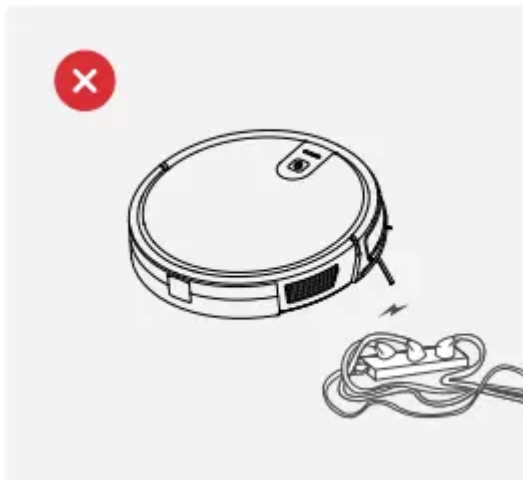

1. Power lines and other debris scattered on the ground may trip up product must be removed.

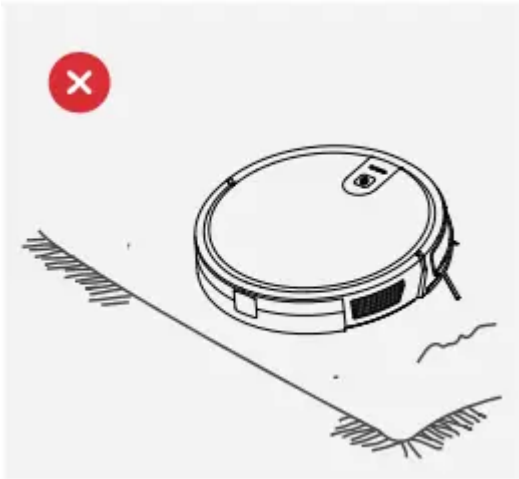

2. Please roll the carpet tassels or work on short-hair rugs.



3. A gap of less than 8 cm on the bottom of the furniture may catch the product. If you need to clean it, please remove the furniture.

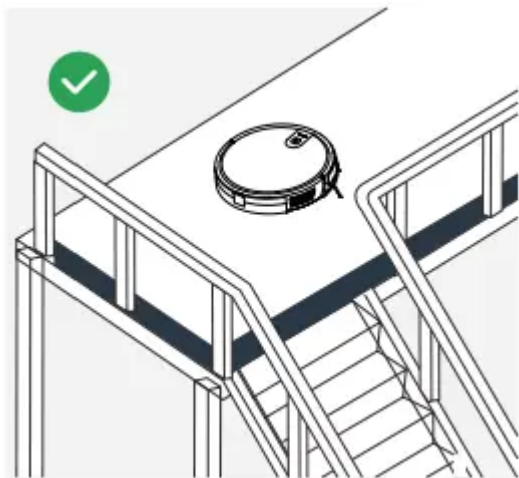

4. A guardrail should be placed at the edge of the duplex to ensure safe operation of the product.

Rapid Operation

Install The Side Brushes

Please install the right brush into the right bottom mounting port of the machine, the left brush into the left bottom mounting port of the machine, and ensure that the two side brushes are in place.

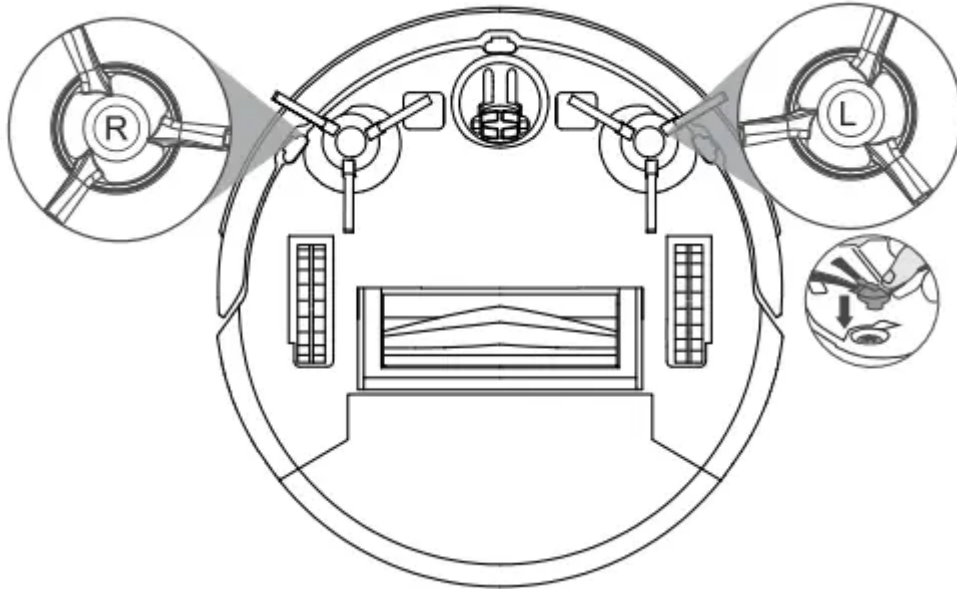

Charging Operation

1. Connect the adapter to the charging stand.

Place the charging stand flat against the wall. Do not place objects in the left and right 1M and the front 2M, and do not have objects with strong reflection surfaces such as mirrors.

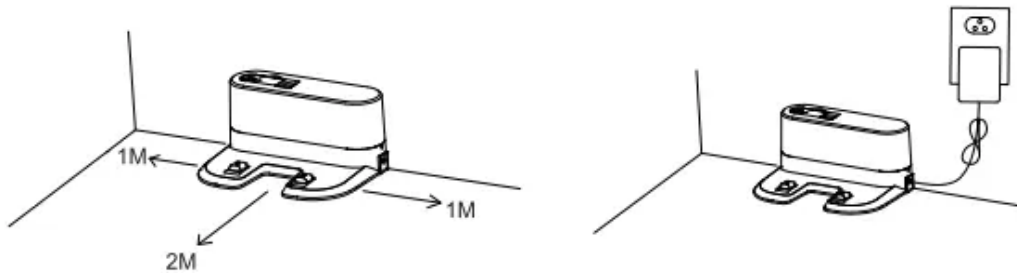

2. Turn On The Master

Please press the start/pause key to turn on the master. It is recommended to keep the master in the charging stand after each time use instead of shutting it down instantly to make sure it can perform well next time.

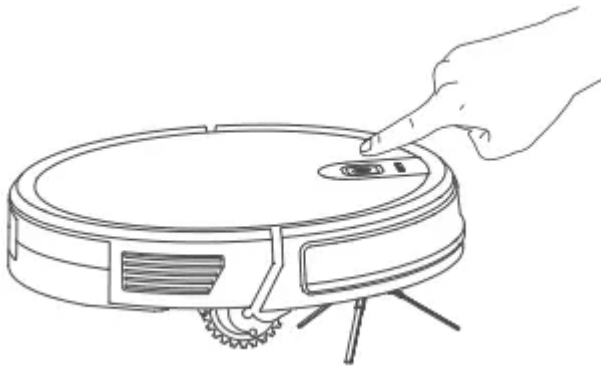

Master Charge

Place the master in the charging stand and pay attention to the charging pole piece.

Turn on the power switch, the robot will enter standby mode.



Red light flashes indicates that the battery need to be charged.



Blue light breathing light flashes indicate charging.



When the blue light is off means charging is completed.

For the first use, please charge continuously for more than 6 hours.

Note: Please match the charging pole piece.

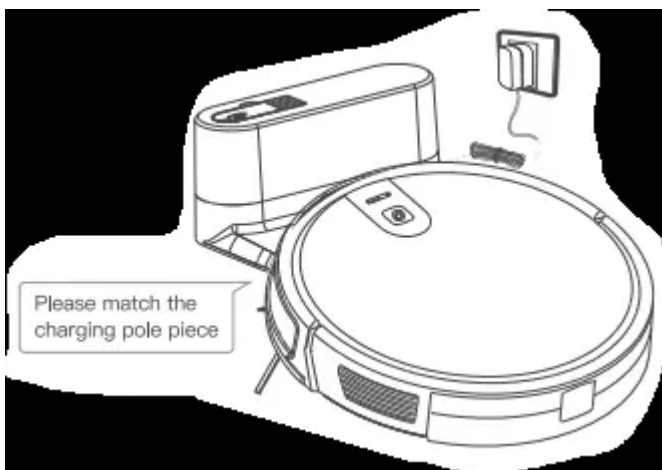

Start/Stop Cleaning

1. Start or stop by pressing the master's  key or the remote control's  /  key.

Note: Before starting the mode, make sure that the outer ring of the  key is blue and the master is in the state of being awakened. If the master does not wake up, short press the master



to wake it up.

The master enters the sleep state after 10 minutes of standby, and the  key light is off.

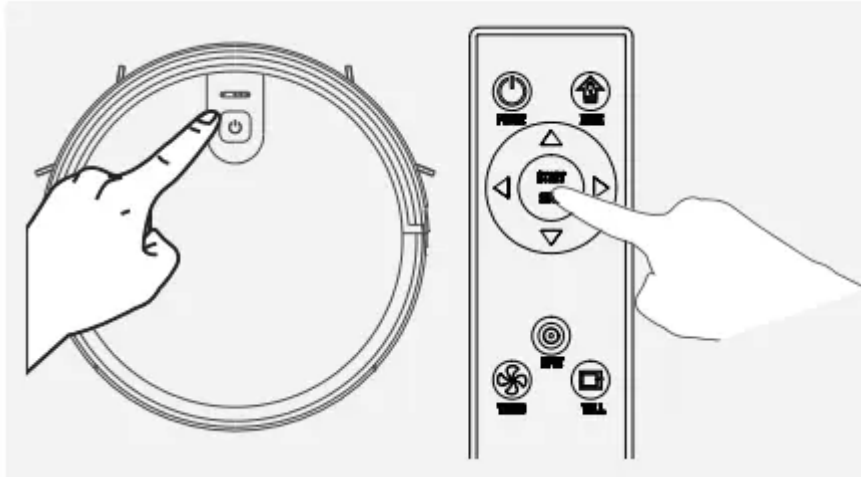

2. If you need to select another mode, please refer to the (Mode Selection) section.



Mode Selection

In order to adapt to different ground conditions and achieve deep cleaning, this product has a variety of cleaning modes, which can be selected by remote control as needed.

The remote control can switch any mode directly.

Before starting the mode, make sure that the outer ring of the  key is blue and the master is in the state of being awakened. If the master does not wake up, short press the master  to wake it up.

Fixed-point Mode

It is suitable for the ground environment where the garbage is concentrated. The master centralized cleaning in the designated area, and master centralized cleaning with the "spiral" route.

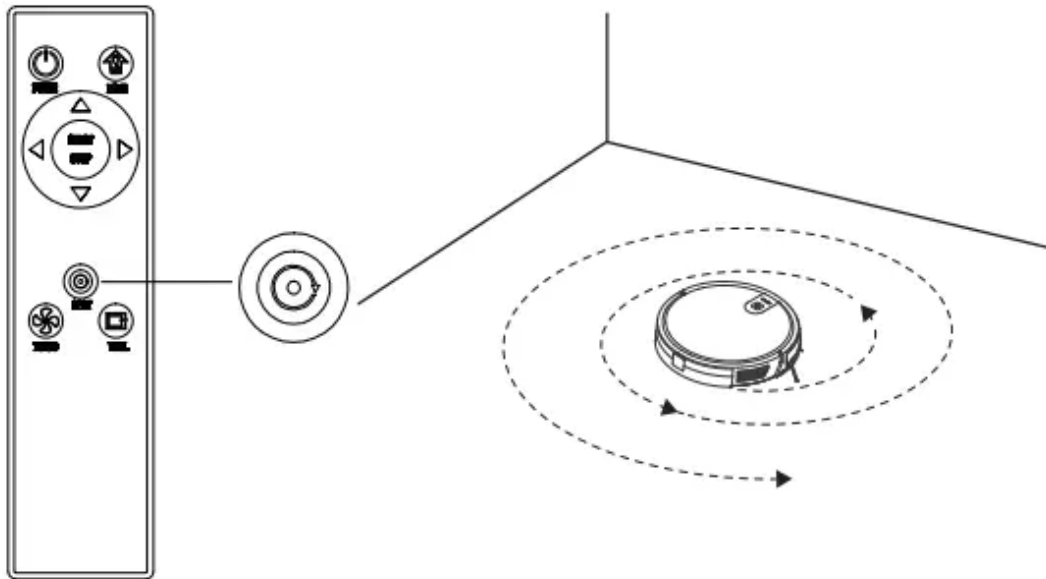

Edge Mode

It is suitable for cleaning at the corners of the room. The master is cleaned around the periphery of a fixed object (such as a wall) and cleaned back to the charging stand.

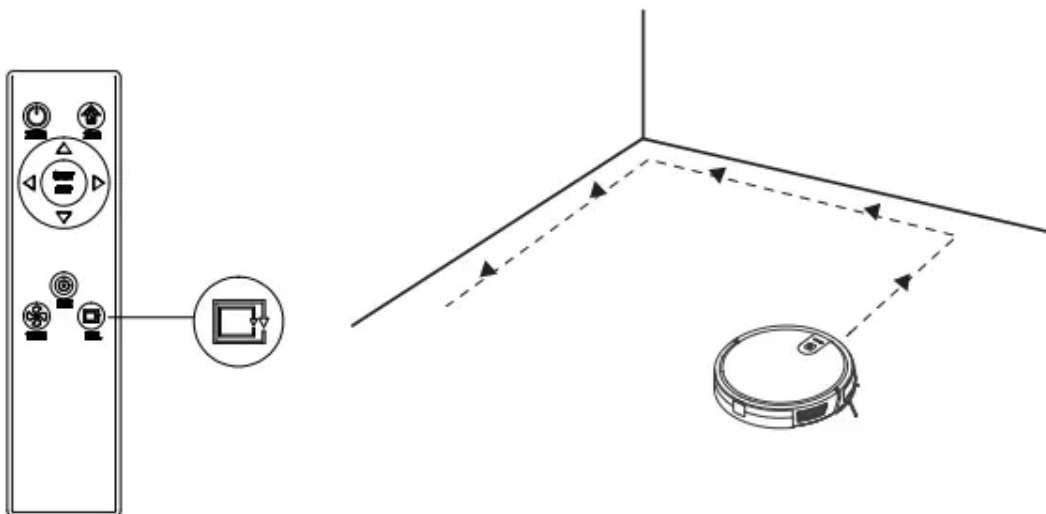

Return Charging Mode

During the cleaning process, the master can sense that its power is insufficient, and automatically find the charging stand for charging.

You can press the “home” button or press the “power” button twice to make the master return to the charging stand for charging.

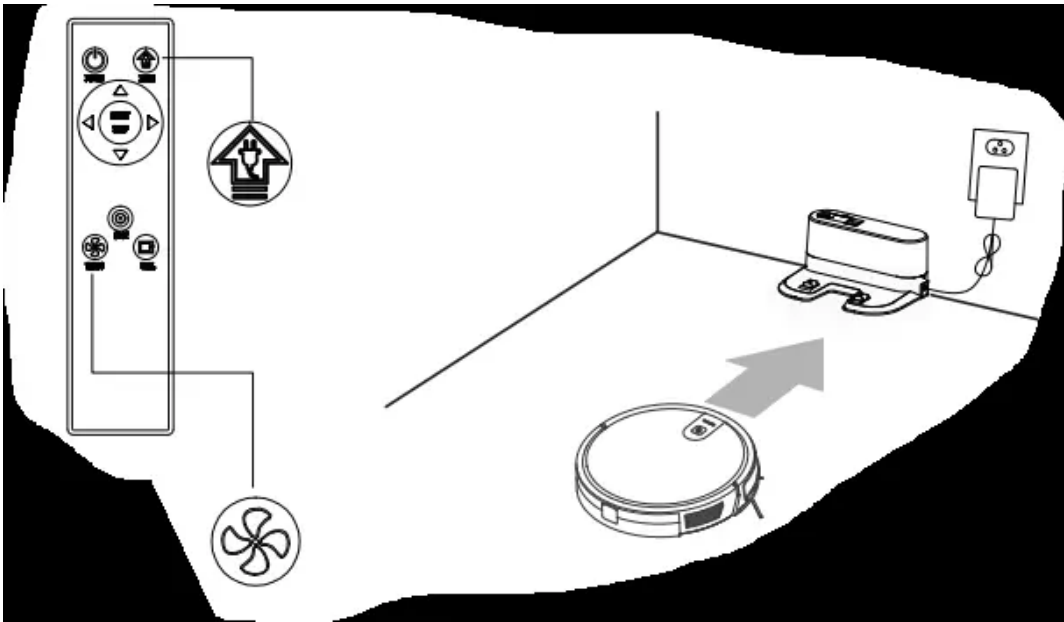

Suction Power Setting

Press the “Turbo” button on the remote control.

With three modes of suction power(Max/Standard/Low). Standard mode can be used for daily cleaning while the Max mode would increase the suction and Low mode would lower the noise.

Roller Brush Assembly and Cleaning

Remove the roller brush brush cover plate, remove the roller brush, cut off the hair wound on it and then use the cleaning brush to clean it.

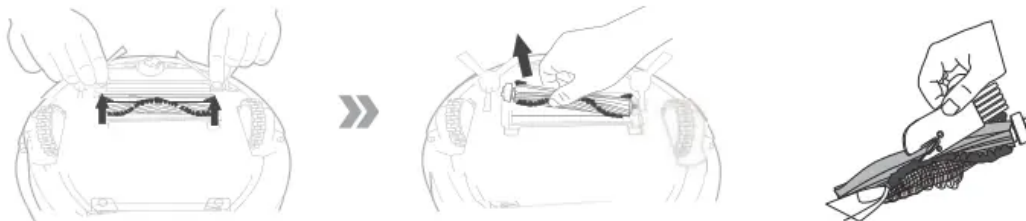

Set roller brush assembly: take out sucking assembly first, set the roller brush, cover the board and press it to lock.



Maintenance

Dust Box and Filter

When cleaning and maintaining the master and its accessories, turn off the master and unplug the charging stand.

1. Remove the dust box, open the dust box cover, and clean the garbage.
2. Remove dust filter. HEPA is not recommended for washing. Please pat and remove ash.
3. Flush the dust box and the primary filter.
4. Dry the dust box and the dust filter assembly and keep it dry to ensure its service life.

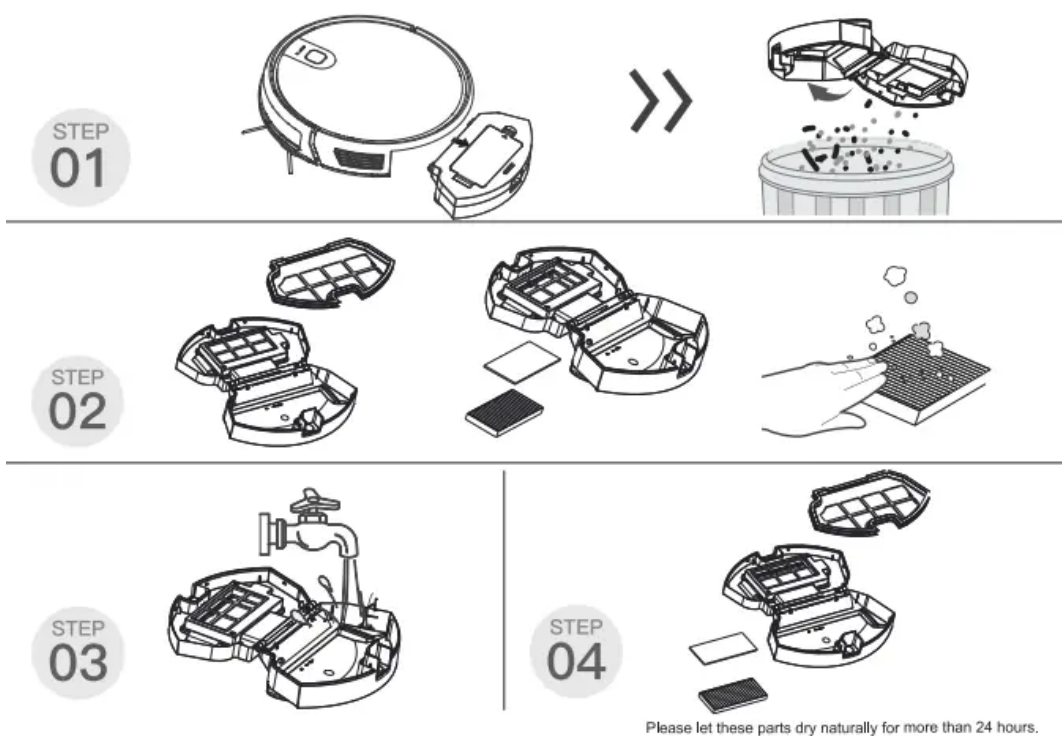

Side Brushes

Cleaning Side Brushes

Pull out the side brush and wipe it with a clean rag.

Other Assembly

Cleaning the universal wheel to reduce hair entangle.

Clear down the sensor to ensure the sensitivity of the sensor.

To clean the charging pole pieces, use a dry rag to clean the charging poles on the bottom of the master or the charging stand.

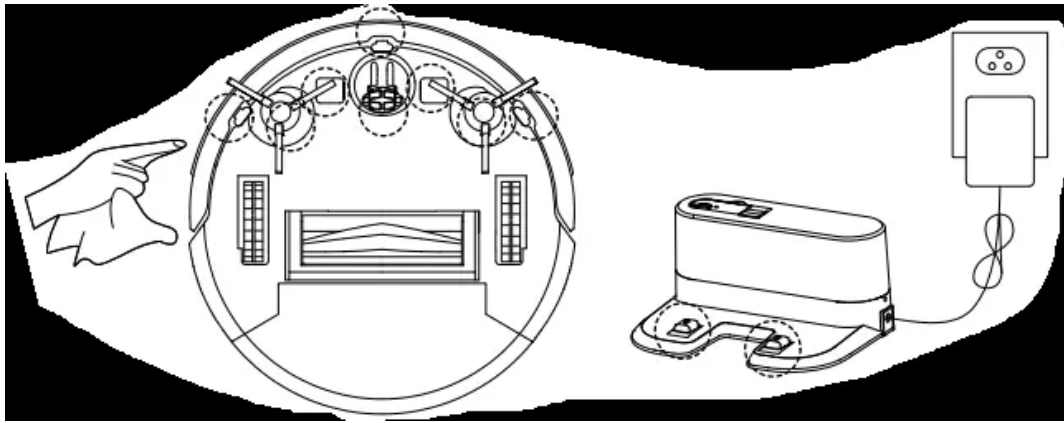

If you will not use the product for a long time, please remove the battery and keep it in a safe place. If the battery leaks, remove the battery and wipe the battery compartment clean.

This product uses a high-life battery and does not require frequent replacement. If you need to replace, you can contact our company for after-sales service replacement.

Alarm Tips

Cause of Issue	Display light	APP content	Solution
Side brush	Red light on	Please check side brushes are jammed	Clean side brush
Fan abnormality	Red light on	Motor cooling error	Please wait an hour before using
Roller brush	Red light on	Please check roller brush is jammed	Clean roller brush
No dustbin inside	Red light on	Please check if dustbin is installed correctly	Please check whether dustbin put in position
Failure of ground detection	Red light flush	Please check if wheels are on the floor	Clean the ground detector and make sure I am not picked
Out of trouble	Red light flush	Please help me, I'm stuck	Please take me to the open space
Low battery	Red light flush	Battery low, please recharge me	Manually move the cleaner back to the dock station recharging
Abnormality charging	Red light flush	Please turn on the power switch for charging	Please turn on the power switch for charging
Gyroscope fail	Red light flush	Navigation failure, please restart me	Turn on the switch again

FAQ

Please install the right brush into the right bottom mounting port of the machine, the left brush into the left bottom mounting port of the machine, and ensure that the two side brushes are in place.

Q : What should I do when it can not work on the carpet ?

A: We don't suggest you make it clean the carpet. It's better for you to set the barrier around the carpet on the app.

Q : What if the strength of vacuuming is weak?

A: First of all, check whether the dust bin is full and the robot is full charged. If it does, you can try to switch it to the higher mode. For litter which is difficult to collect, try to clean it with Spot Cleaning Mode.

Q: What if my charger has difficulties charging the robot?

A: Please make sure you turn on the charging stand before charging and check if the electrical sheet is connected to the charging stand(Put it back manually or press the Power button when the robot is 1 meter in front of the charging stand.)

Q : What if the robot can not find the charging stand?

A: The charging stand should be placed against the wall with at least 1 meter clearance each side and 2 meters in front .Sometimes you can just put it back manually.

Q: What should I do if the remote control is out of order?

A: 1. The remote control has an effective control distance of 5 meters. Please make sure that the remote point to the master.

2. Replace the battery with a new one if the battery has run out capacity.
3. Please make sure the master power switch is turned on and has sufficient power to complete the operation.
4. Please wipe the infrared emitter of the remote control and the infrared receiver of the master with clean towel.

Q: Why does the master return to charging after cleaning?

A: The working time of the master varies depending on the complexity of the room, the amount of garbage and the cleaning mode.

Customer Service

CUSTOMER CARE

The 1-year Limited Warranty is valid for products purchased from our APOSEN only, starting from the date of the original retail purchase. We will provide customer service for any defects in quality or materials under normal, non-commercial use.

1. According to the requirements outlined in this instruction manual, the warranty is subject to the following conditions and exclusions.
2. This warranty provides, at no extra cost to you all labor and parts necessary to ensure your machine is in proper operating condition during the warranty period.
3. We provide the repair or replacement of your APOSEN appliance if your APOSEN appliance is found to be defective due to faulty materials, workmanship function within 1 year of purchase or delivery. (If any part is no longer available or out of manufacture, we will replace it with a functional replacement part).

WHAT IS NOT COVERED

1. Under your APOSEN guarantee, APOSEN shall not be liable for costs of repair or replacement of a product incurred as a result of: Accidental damage, faults caused by negligent use or care, misuse, neglect, careless operation or handling of the APOSEN appliance which is not in accordance with this APOSEN Instruction Manual.
2. Machines purchased from an unauthorized dealer.
3. Use of parts and accessories other than those produced or recommended by APOSEN.
4. Repairs or alterations carried out by unauthorized parties or agents.
5. Use of the machine other than for normal domestic purpose, e.g. for commercial or rental purposes.
6. Reduction in battery run time due to battery age or use.

Warning

This content is compiled from multiple sources and is provided for reference purposes only. It may not be complete or fully applicable to all situations. If you are unable to resolve your issue, please contact the product manufacturer or an authorized service provider for official support.