

Preparing

Lifting and moving the TV

- Please note the following advice to prevent the TV from being scratched or damaged and for safe transportation regardless of its type and size.
- It is recommended to move the TV in the box or packing material that the TV originally came in.
- Before moving or lifting the TV, disconnect the power cord and all cables.
- When holding the TV, the screen should face away from you to avoid damage.
- Hold the side and bottom of the TV frame firmly. Make sure not to hold the transparent part, speaker, or speaker grill area.
- When transporting a large TV, there should be at least 2 people.
- When transporting the TV by hand, hold the TV as shown in the following illustration.
- When transporting the TV, do not expose the TV to jolts or excessive vibration.
- When transporting the TV, keep the TV upright, never turn the TV on its side or tilt towards the left or right.
- Do not apply excessive pressure to cause flexing / bending of frame chassis as it may damage screen.
- When handling the TV, be careful not to damage the protruding buttons.

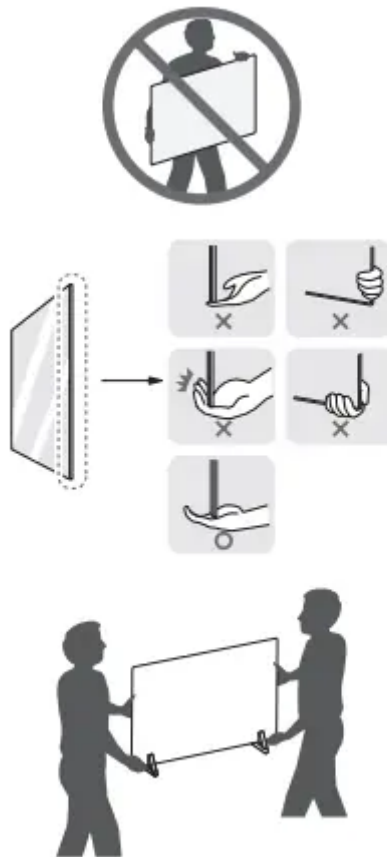

Mounting on the Table

1. Lift and tilt the TV into its upright position on a table.
 - Leave a 10cm (minimum) space from the wall for proper ventilation.
2. Connect the power cord to a wall outlet.

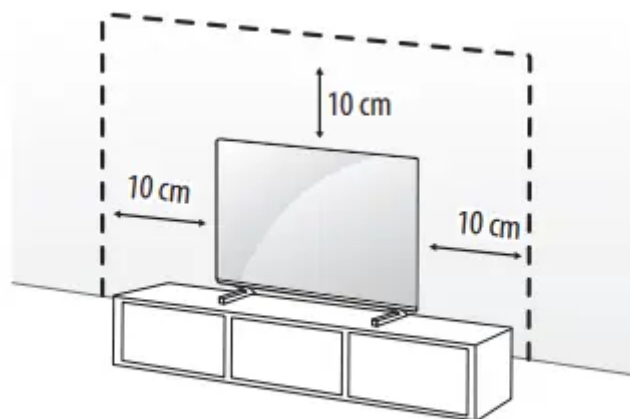

(Depending on model)

Securing TV to the Wall

1. Insert and tighten the eye-bolts, or TV brackets and bolts on the back of the TV.
 - If there are bolts inserted at the eye-bolts position, remove the bolts first.
2. Mount the wall brackets with the bolts to the wall. Match the location of the wall bracket and the eye-bolts on the rear of the TV.
3. Connect the eye-bolts and wall brackets tightly with a sturdy rope. Make sure to keep the rope horizontal with the flat surface.
 - Use a platform or cabinet that is strong and large enough to support the TV securely.
 - Brackets, bolts and ropes are not provided. You can obtain additional accessories from your local dealer.

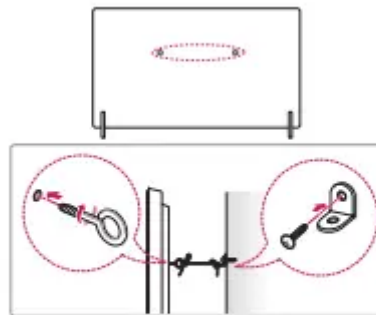

(Depending on model)

Stand

(Depending upon model)

Stand	Model
AP-G1DV55	OLED55G1*
AP-G1DV65	OLED65G1*
AP-G1DV77	OLED77G1*

Mounting to the Wall

Attach an optional wall mount bracket at the rear of the TV carefully and install the wall mount bracket on a solid wall perpendicular to the floor. When you attach the TV to other building materials, please contact qualified personnel. LG recommends that wall mounting be performed by a qualified professional installer. We recommend the use of LG's wall mount bracket. LG's wall mount bracket is easy to move with cables connected. When you do not use LG's wall mount bracket, please use a wall mount bracket where the device is adequately secured to the wall with enough space to allow connectivity to external devices. It is advised to connect all the cables before installing fixed wall mounts.

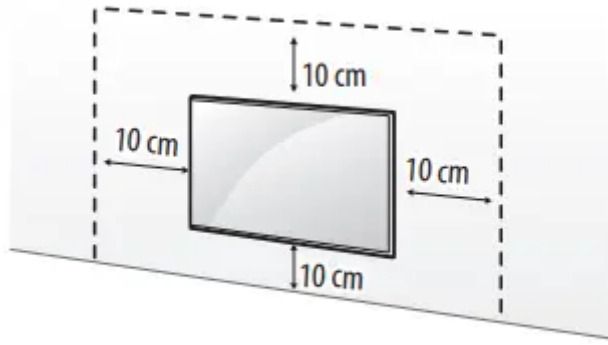

(Depending on model)

Wall Mounting Bracket

(Depending on model)

Make sure to use screws and wall mount bracket that meet the VESA standard. Standard dimensions for the wall mount kits are described in the following table.

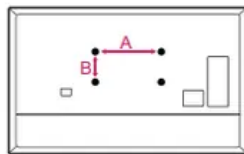

Model	OLED55/65/77G1*
VESA (A x B) (mm)	300 x 300
Standard screw	M6
Number of screws	4
Wall mount bracket	OLW480B

Precautions for Safety

(Except for OLW480B)

- Professional installers should read this manual carefully to ensure proper installation.
- Professional installers should forward this manual to customers after installation and encourage them to read and store it in a convenient place for future reference.

After reading the installation manual, keep it in a convenient place for future reference.

Before Installation

(Except for OLW480B)

- Do not use the product for any purpose other than installing the TV on a wall.
- Avoid product damage and safety accidents caused by careless installing or use of improper or unauthorized wall mount.

- Follow the instructions in the installation manual for a convenient installation of the wall mount.
- Immediately discontinue installation and contact the service centre if you cannot fully understand the installation process.
- Use a professional installer if any installation issues remain after the inquiry.
- Installation of this product on a concrete wall or wood stud is recommended. Installation of this product on other surfaces (Dry wall, plywood, bricks, etc.) is not recommended. Improper installation may result in the product falling.
- Install the product only on a vertical wall. Do not install on a tilted wall that exceeds building standards or on the heavily tilted wall or ceiling. LG is not responsible for problems caused by improper installation of the product, e.g., heavily tilted walls and ceilings.
- Check the enclosed accessories before installation. We are not responsible for any lost or damaged accessories after the inner packaging is opened.
- When an infant or small child swallows the enclosed accessories, various safety accidents such as choking may occur. Keep the enclosed accessories out of the reach of infants and children.
- When tightening screws, tighten until fully snug. Avoid using excessive force when tightening the screws. Doing so may damage the wall and product or reduce the rigidity or performance of the product.
- Avoid installing a TV that exceeds the specified tensile load, and do not allow any external force to be applied to the product.
- Avoid accidents by using work tools with care during installation.

Tools for Installation

- "+" shaped screwdriver (manual or electric) / level / drill / Ø 8 mm drill bit for concrete or Ø 4 mm drill bit for steel

Securing TV to the Wall

(Except for OLW480B)

- Please use the TV close to the wall after installation.

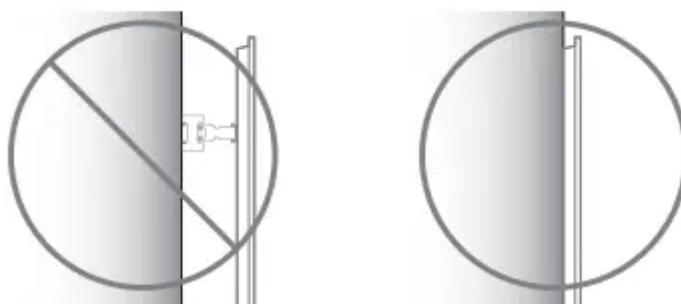

How to fix anchors and screws

(Except for OLW480B)

Please make sure that:

- Check that the material and thickness of the wall and finishing material comply with the installation manual. Before beginning the mounting process, you must be sure the wall is able to support the weight of the TV.
- Should use the enclosed anchors and screws on crack-free concrete walls.
- Never install the product on a plasterboard or wall made of paper or medium-density fiberboard (MDF). When it is necessary to install the product on such wall, anchor screws must be fastened to retaining walls (concrete) or wood Stud inside the finishing material.
- The wall mount should be attached to a stud. This usually will not be a problem, but depending on individual circumstances, there may be cases when the ability to mount into a stud is not possible. In this case, there are a variety of drywall anchors, such as toggle bolts, which may provide a solution. If using drywall anchors, please be sure the anchors and the wall have the ability to support the weight of your TV. Please note that the supplied anchors may not be the correct ones for your individual situation, so you should check with a local professional.
- Other unspecified walls must be capable of supporting pullout loads of over 70kgf (686 N) and shear loads of over 100kgf (980 N) per fastener.
- Use an Ø 8 mm drill bit for concrete and a hammer (impact) drill or Ø 4 mm drill bit for wood stud to drill holes.

For installation on concrete wall

1. Drill holes in anchor locations with a drill bit of Ø 8 mm to a depth of 80 mm to 100 mm.
2. Clean the drilled holes.
3. Insert the enclosed anchors for fixing the wall mount into the holes. (Use a hammer when inserting anchors.)
4. Push the wall mount support closely toward the wall to match the hole locations.
5. Tighten screws for fixing the wall mount to the holes. At this time, tighten the screws to a torque of between 45kgf/cm to 60kgf/cm.

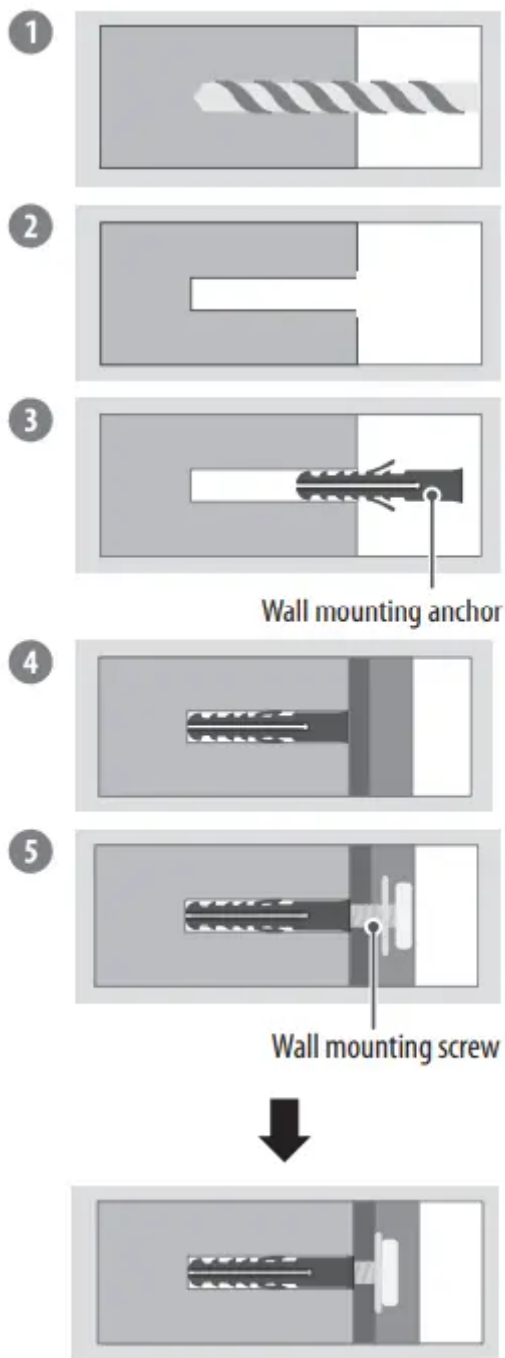

For installation on wood stud

Use the \varnothing 4 mm drill bit for wood to drill holes with the depth of 76 mm. (Clean the drilled hole.)

Without using the wall mounting anchor, fasten the wall mounting screw directly to the wood stud.

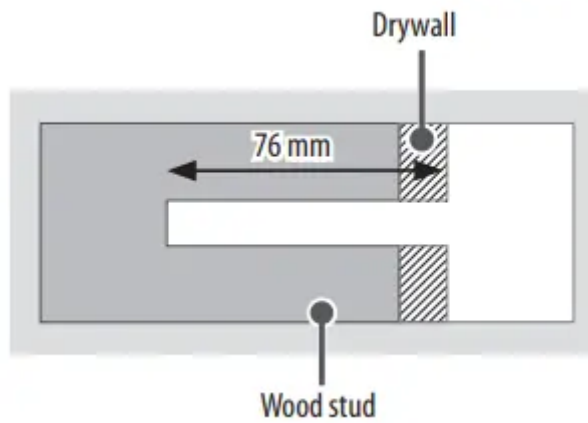

After Installation

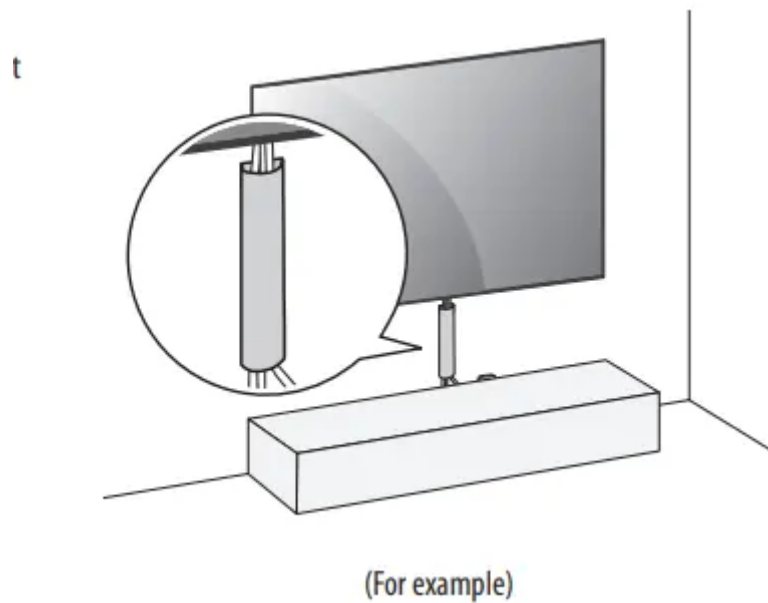

Antenna/Cable

Connect the TV to a wall antenna socket with an RF cable (75 Ω).

- Use a signal splitter to use more than 2 TVs.
- If the image quality is poor, install a signal amplifier properly to improve the image quality.
- If the image quality is poor with an antenna connected, try to realign the antenna in the correct direction.
- An antenna cable and converter are not supplied.
- For a location that is not supported with Ultra HD broadcasting, this TV cannot receive Ultra HD broadcasts directly.

Satellite dish

Connect the TV to a satellite dish to a satellite socket with a satellite RF cable (75 Ω).
(Depending on model)

Starting TV

Turning on the TV

You can simply operate the TV functions, using the button.

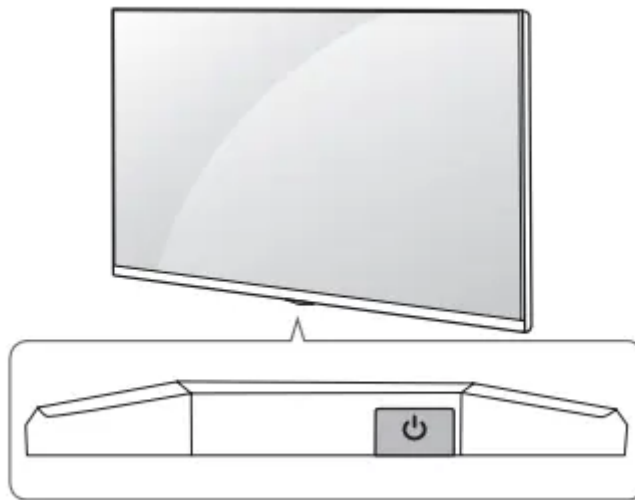

Using button



Power On (Press)

Power Off1) (Press and Hold)

Menu Control (Press2))

Menu Selection (Press and Hold3))

1. All running apps will close, and any recording in progress will stop. (Depending on country)
2. You can access and adjust the menu by pressing the button when TV is on.
3. You can use the function when you access menu control.

Adjusting the menu

When the TV is turned on, press the !⏻ button one time. You can adjust the Menu items using the button.

 Turns the power off.



 Changes the input source.

 Adjusts the volume level.

 Scrolls through the saved programmes.

Inserting the battery

When the message [Magic Remote battery is low. Please change the battery.] is displayed, replace the battery.

To replace batteries, open the battery cover, replace batteries (1.5 V AA) matching the  and  ends to the label inside the compartment, and close the battery cover.





Registering Magic Remote Control



How to register the Magic Remote Control

To use the Magic Remote, first pair it with your TV.

1. Put batteries into the Magic Remote and turn the TV on.
2. Point the Magic Remote at your TV and press the  Wheel (OK) on the remote control.
 - If the TV fails to register the Magic Remote, try again after turning the TV off and back on.

How to deregister the Magic Remote Control

Press the  (Back) and  (Home) buttons at the same time, for five seconds, to unpair the Magic Remote with your TV.

- Press and hold the  (Home) and  (Q. Settings) buttons for more than 5 seconds to disconnect and re-register the Magic Remote at the same time.

Connecting Smart Devices using NFC Tagging

Using the NFC Feature

NFC is technology that uses Near Field Communication, allowing you to conveniently send and receive information without separate settings.

By bringing a smart device near the NFC-enabled remote control, you can install the LG ThinQ app and connect the device to the TV.















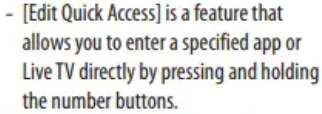

1. Turn on NFC in the smart device's settings. To use NFC with Android devices, set the NFC option to enable 'read/write tags' in the smart device's settings. The NFC settings may vary depending on the device.
2. Bring the smart device near the  (NFC) on the remote control. The required distance for NFC tagging is about 1 cm.
3. Follow the instructions to install the LG ThinQ app on your smart device.
4. Retagging the smart device to the remote control allows you to conveniently access various features on the connected TV through the LG ThinQ app

Using Remote Control

















Using Magic Remote Control

(Depending on model)

The descriptions in this manual are based on the buttons on the remote control. Please read this manual carefully and use the TV correctly

-  **Power** Turns the TV on or off.
-  **GUIDE**** Accesses the saved programmes list.
-  **QUICK ACCESS**** Accesses the [Guide].
-  **QUICK ACCESS**** Accesses the [Edit Quick Access].
-  - [Edit Quick Access] is a feature that allows you to enter a specified app or Live TV directly by pressing and holding the number buttons.
-  **Volume buttons** Adjusts the volume level.
-  **Programmes buttons** Scrolls through the saved programmes.
-  **Home** Accesses the Home menu.
-  **Home**** Launches the last used apps.
-  **Input** Changes the input source.
-  **Input**** Accesses the [Home Dashboard].
-  **Wheel (OK)** Press the centre of  button to select a menu. You can change programmes by using  button.
-  **Wheel (OK)**** Accesses the [Magic Explorer]. You can run the [Magic Explorer] feature when the pointer colour is changed to purple. If watching a programme, press and hold down the pointer onto the video. When using [TV Guide], [Settings], [Sports Alert], or [Art Gallery], press and hold down on the text.
-  **Back** Returns to the previous level.
-  **Back**** Clears on-screen displays and returns to last input viewing.



-  **Number buttons** Enters numbers.
-  **9**** Accesses the [Quick Help].
-  **More actions** Displays more remote control functions.
-  **AD/SAP**** Audio descriptions function will be enabled.
-  **Mute** Mutes all sounds.
-  **Mute**** Accesses the [Accessibility] menu.
-  **Voice recognition** Network connection is required to use the voice recognition function.
-  **Voice recognition** Check for recommended content. (Some recommended services may not be available in some countries.)
-  **Voice recognition** Speak while pressing and holding the button to use the voice recognition feature.
-  **Q. Settings** Accesses the Quick Settings.
-  **Q. Settings**** Displays the [All Settings] menu.
-  **Up/Down/Left/Right** Press the up, down, left or right button to scroll the menu. If you press  buttons while the pointer is in use, the pointer will disappear from the screen and Magic Remote will operate like a general remote control. To display the pointer on the screen again, shake Magic Remote to the left and right.
-  **Special function buttons** These access special functions in some menus.
-  **Red button** Runs the record function.
-  **Streaming Service buttons** Connects to the Video Streaming Service.

Connections

Connect various external devices to the TV and switch input modes to select an external device. For more information of external device's connection, refer to the manual provided with each device.

HDMI

- When connecting the HDMI cable, the product and external devices should be turned off and unplugged



- Supported HDMI Audio format (Depending on model):
 - True HD (48 kHz),

- Dolby Digital / Dolby Digital Plus (32 kHz, 44.1 kHz, 48 kHz), PCM (32 kHz, 44.1 kHz, 48 kHz, 96 kHz, 192 kHz)

Note

- If the device connected to Input Port also supports HDMI Deep Colour, your picture may be clearer. However, if the device doesn't support it, it may not work properly. In that case, change the TV's [HDMI Deep Colour] setting to off.

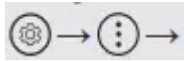
-  General] → [Devices] → [HDMI Settings] → [HDMI Deep Colour]

- On: Support 4K @ 50/60 Hz (4:4:4, 4:2:2, 4:2:0), 4K @ 100/120 Hz (4:4:4, 4:2:2, 4:2:0)
 - Off: Support 4K @ 50/60 Hz (4:2:0)
- Use a certified cable with the HDMI logo attached.
 - If you do not use a certified HDMI cable, the screen may not display or a connection error may occur.
 - Recommended HDMI Cable Types
 - Ultra High Speed HDMI®/™ cable (3 m or less)

USB

- Some USB Hubs may not work. If a USB device connected using a USB Hub is not detected, connect it to the USB port on the TV directly

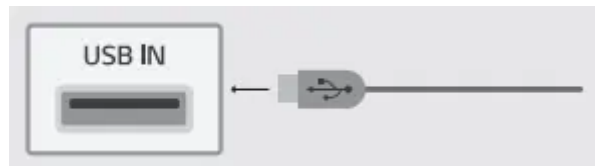

Note

- For an optimal connection, HDMI cables and USB devices should have bezels less than 10 mm thick, 18 mm width and 8 mm a wire diameter. Use an extension cable that supports USB 2.0 or higher if the USB cable or USB memory stick does not fit into your TV's USB port.

- A ≤ 10 mm
- B ≤ 18 mm
- C ≤ 8 mm

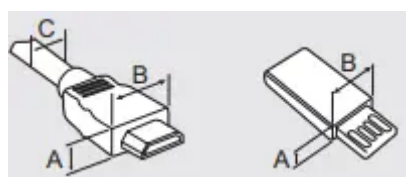

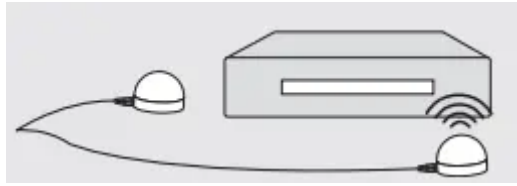

IR Blaster

- Control the set-top box (cable/satellite/IP/OTT), Blu-ray/DVD player, soundbar, game consoles, etc., using the IR Blaster. (Depending on country)



Note

- Connect the IR Blaster cable to the TV's IR Blaster port.
- Place both ends (one or two) of the IR Blaster in front of the external device as shown in the picture below.
- Use universal control settings to control the device. Go to  →  → [General] → [Devices] → External Devices] → [Universal Control Settings].
- Secure the IR Blaster with the 3M tape provided.

CI module

- View the encrypted (pay) services in digital TV mode. (Depending on model)

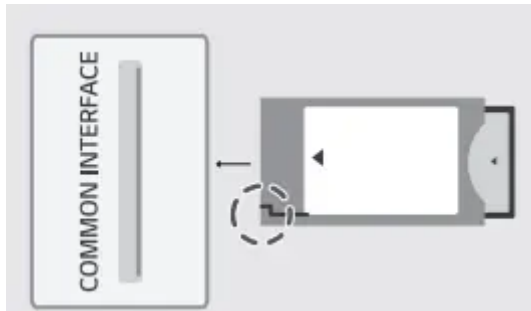

Note

- Check if the CI module is inserted into the COMMON INTERFACE in the right direction. If the module is not inserted properly, this can cause damage to the TV and the COMMON INTERFACE .
- If the TV does not display any video and audio when CI+ CAM is connected, please contact to the Terrestrial/Cable/Satellite Service Operator.

External Devices

- Available external devices are: Blu-ray player, HD receivers, DVD players, VCRs, audio systems, USB storage devices, PC, gaming devices, and other external devices.

Note

- The external device connection may differ from the model.

- Connect external devices to the TV regardless of the order of the TV port.
- If you record a TV programme on a Blu-ray/DVD recorder or VCR, make sure to connect the TV signal input cable to the TV through a DVD recorder or VCR. For more information of recording, refer to the manual provided with the connected device.
- Refer to the external equipment's manual for operating instructions.
- If you connect a gaming device to the TV, use the cable supplied with the gaming device.
- In PC mode, there may be noise associated with the resolution, vertical pattern, contrast or brightness. If noise is present, change the PC output to another resolution, change the refresh rate to another rate or adjust the brightness and contrast on the [Picture] menu until the picture is clear.
- In PC mode, some resolution settings may not work properly depending on the graphics card.
- If Ultra HD content is played on your PC, video or audio may become disrupted intermittently depending on your PC's performance. (Depending on model)
- When connecting via a wired LAN, it is recommended to use a CAT 7 cable. (Only when LAN port is provided.)

Troubleshooting

- **Cannot control the TV with the remote control.**
 - Check the remote control sensor on the product and try again.
 - Check if there is any obstacle between the product and the remote control.
 - Check if the batteries are still working and properly installed (to , to).
- **No image display and no sound is produced.**
 - Check if the product is turned on.
 - Check if the power cord is connected to a wall outlet.
 - Check if there is a problem in the wall outlet by connecting other products.
- **The TV turns off suddenly.**
 - Check the power control settings. The power supply may be interrupted.
 - Check if the auto-off function is activated on the settings related time.
 - If there is no signal while the TV is on, the TV will turn off automatically after 15 minutes of inactivity.
- **When connecting to the PC (HDMI), no signal is detected.**
 - Turn the TV off/on using the remote control.

- Reconnect the HDMI cable.
- Restart the PC with the TV on.

- **Abnormal Display**

- If the product feels cold to the touch, there may be a small “flicker” when it is turned on. This is normal, there is nothing wrong with product.
- This panel is an advanced product that contains millions of pixels. You may see tiny black dots and/or brightly coloured dots (white, red, blue or green) at a size of 1 ppm on the panel. This does not indicate a malfunction and does not affect the performance and reliability of the product. This phenomenon also occurs in third-party products and is not subject to exchange or refund.
- You may find different brightness and colour of the panel depending on your viewing position(left/right/ top/down).
- This phenomenon occurs due to the characteristic of the panel.
- It is not related with the product performance, and it is not malfunction.

- **Generated Sound**

- “Cracking” noise: A cracking noise that occurs when watching or turning off the TV is generated by plastic thermal contraction due to temperature and humidity. This noise is common for products where thermal deformation is required.
- Electrical circuit humming/panel buzzing: A low level noise is generated from a high-speed switching circuit, which supplies a large amount of current to operate a product. It varies depending on the product.
- This generated sound does not affect the performance and reliability of the product.

Specifications

(Depending on country)

Broadcasting Specifications				
	Digital TV			Analogue TV
Television system	DVB-T/T2, DVB-C, DVB-S/S2			PAL B/B, PAL B/G, PAL D/K, PAL-I, SECAM B/G, SECAM D/K, NTSC-M
Programme coverage	DVB-S/S2 ¹⁾	DVB-C ¹⁾	DVB-T/T2 ¹⁾	46 ~ 862 MHz
	950~2,150 MHz	46 ~ 890 MHz	VHF III : 174 ~ 230 MHz UHF IV : 470 ~ 606 MHz UHF V : 606 ~ 862 MHz S Band II : 230 ~ 300 MHz S Band III : 300 ~ 470 MHz	
Maximum number of storable programmes	6,000		3,000	
External antenna impedance	75 Ω			
CI Module (W x H x D)	100.0 mm x 55.0 mm x 5.0 mm			

1) Only DVB-T2/C/S2 support model only.

Wireless module(LGSBWAC95)Specifications	
Wireless LAN (IEEE 802.11a/b/g/n/ac)	
Frequency range	Output Power (Max.)
2,400 to 2,483.5 MHz	19 dBm
5,150 to 5,725 MHz	18 dBm
5,725 to 5,850 MHz	13.5 dBm
Bluetooth	
Frequency range	Output power(Max.)
2,400 to 2,483.5 MHz	9 dBm

As band channels can vary per country, the user cannot change or adjust the operating frequency. This product is configured for the regional frequency table.

For consideration of the user, this device should be installed and operated with a minimum distance of 20 cm between the device and the body.

Environment condition	
Operating Temperature	0 °C to 40 °C
Operating Humidity	Less than 80 %
Storage Temperature	-20 °C to 60 °C
Storage Humidity	Less than 85 %

For information of the power supply and power consumption, refer to the label attached to the product.

The typical power consumption is measured in accordance with IEC 62087 or each country's energy regulations.

On some models, the label is inside the external device connection terminal cover.

Depending on the model or country, the typical power consumption may not be on label.

Warning

This content is compiled from multiple sources and is provided for reference purposes only. It may not be complete or fully applicable to all situations. If you are unable to resolve your issue, please contact the product manufacturer or an authorized service provider for official support.

Document generated by [ManualsFile](#)

