

## Operating the washing machine

### Control panel

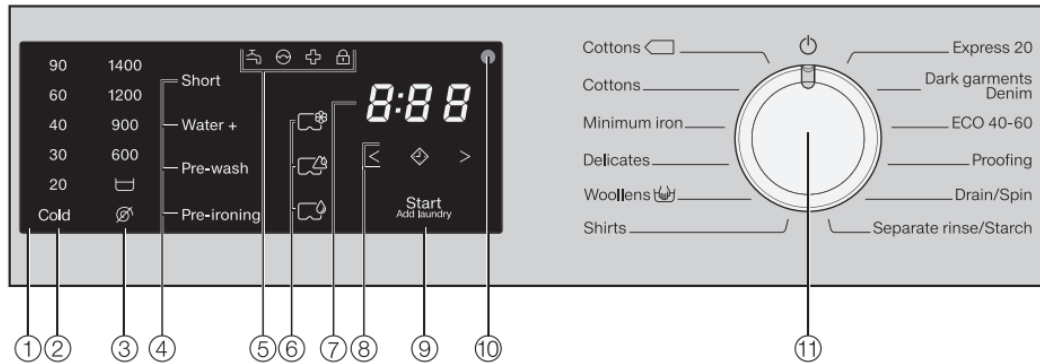

#### 1. Control field

The control field consists of a time display and various sensor controls. The individual sensor controls are explained in the following sections.





#### 2. Sensor controls – temperature for selecting the temperature.

#### 3. Sensor controls – spin speeds for selecting the spin speed.



#### 4. Sensors for extra options

You can supplement wash programmes with extra options. If a wash programme has been selected, the sensor controls for the possible Extras light up dimly.

#### 5. Indicator lights

	lights up if there are faults affecting the water inlet and drainage
	lights up if excess detergent was used
	lights up as a reminder about hygiene information
	The Add laundry function cannot be selected.

#### 6. Sensor controls – CapDosing

	CapDosing of fabric care products (e.g. fabric conditioner, proofing agent)
	CapDosing of additives (e.g. detergent enhancer)
	CapDosing of detergent (for the main wash only)

## 7. Time display







After the programme has started, the programme duration will appear in the display in hours and minutes. When Delay start is being used, the programme duration will appear after the Delay start time has elapsed.

## 8. Sensor controls

The Delay start time selected will appear in the time display.

After the programme has started, the Delay start time will begin to count down.

Once the Delay start time has elapsed, the programme begins and the estimated programme duration appears on the time display

	After touching the  sensor control, a later start time for the programme (Delay start) can be selected. Once selected,  lights up brightly
	The duration of the Delay start period is increased by touching the  sensor control.
	The duration of the Delay start period is reduced by touching the  sensor control.

## 9. Start/Add laundry sensor control

A. The programme can be started as soon as the sensor control is flashing on and off. Touching the Start/Add laundry sensor control starts the selected programme. The sensor control lights up constantly.

B. Once the programme has been started, the Start/Add laundry sensor control allows you to add laundry.

## 10. Optical interface

This is used by the Service department as a transmission point.

## 11. Programme selector

for selecting programmes and for switching off the appliance. The washing machine is switched on when you select a programme, and switched off by turning the programme selector to the  position.

# Select a programme

## Programme selection

The washing machine is switched on by turning the programme selector to a wash programme.

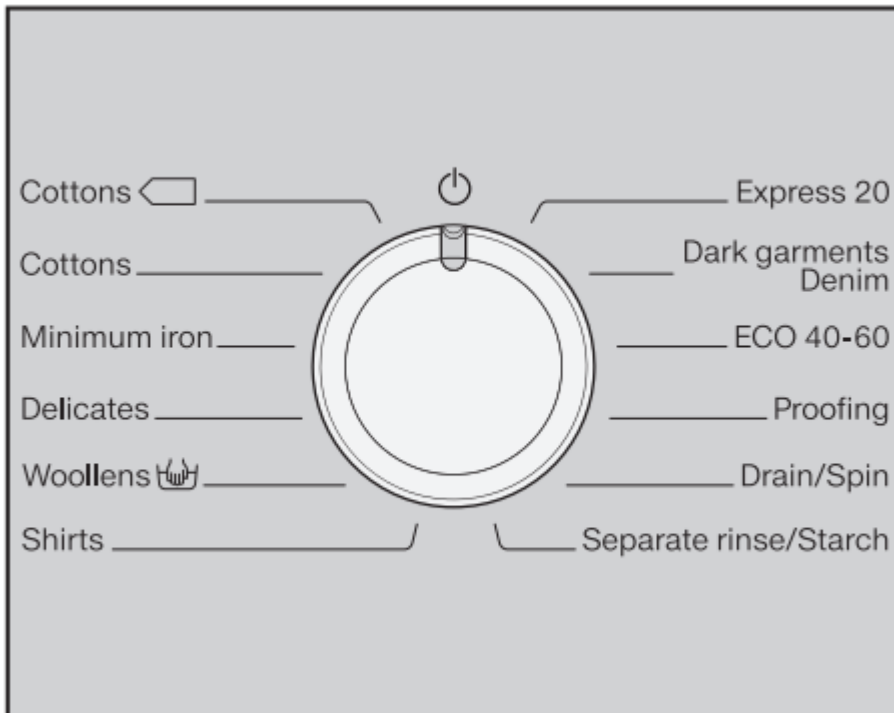

- Turn the programme selector to the required programme.

The likely wash time is shown in the time display and the pre-set temperature and spin speed light up in the control panel.

## Selecting a temperature and spin speed

The temperatures reached inside the washing machine might not be the same as the temperatures selected. Perfect wash results are achieved through a combination of energy use and wash duration.

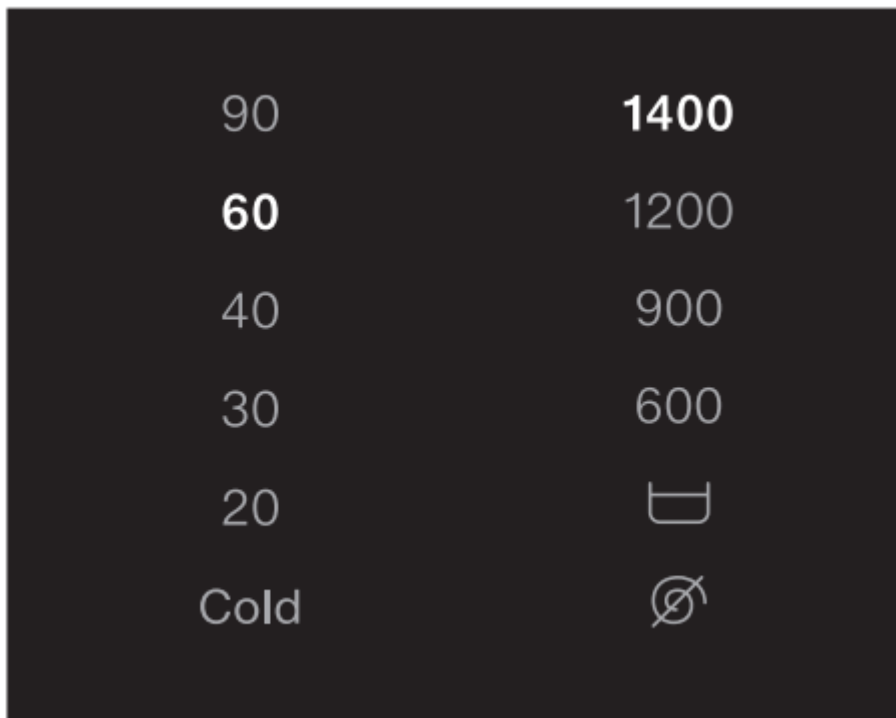

- Touch the sensor for the desired temperature. It will then light up brightly.
- Touch the sensor for the desired spin speed. It will then light up brightly.

#### Selecting Extras

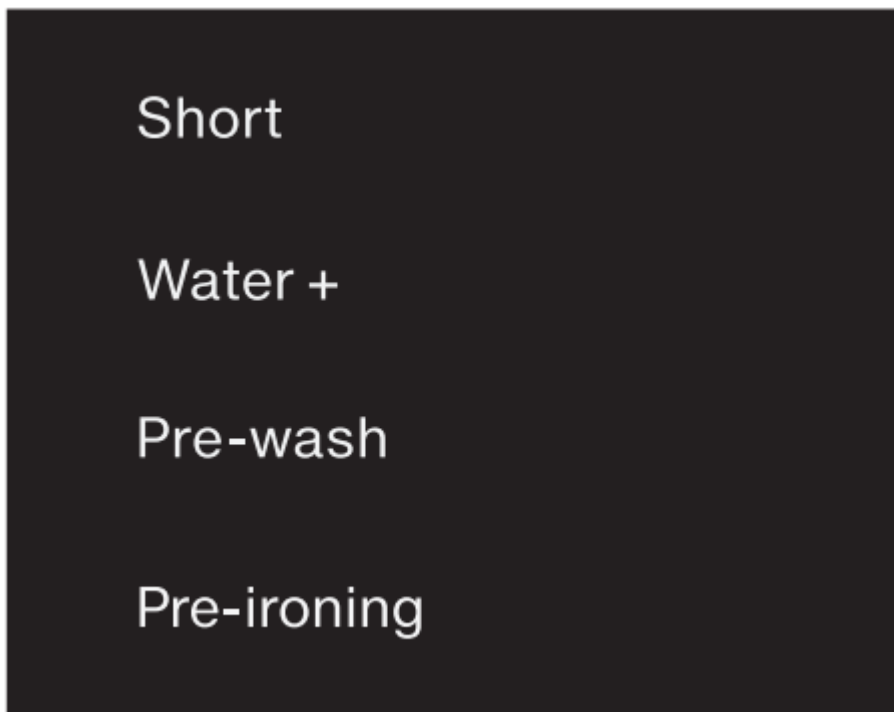

- Touch the sensor for the extra you want. It then lights up brightly

## Start the programme

### Starting a programme

- Touch the flashing Start/Add laundry sensor control.

The door locks and the programme starts.

If a Delay start time has been selected, this counts down on the time display. At the end of the Delay start time or immediately after the programme has started, the programme duration appears on the time display.

### Energy savings

After 10 minutes, the indicators dim. The sensor control Start/Add laundry flashes.

To reactivate the indicators:

- Touch the Start/Add laundry sensor control (this does not have any effect on a programme that is running).

### Adding laundry during a programme sequence

- Touch the Start/Add laundry sensor control.

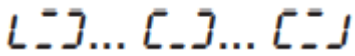
Rotating bars  are shown on the time display.

If the word *Add* appears on the time display, the door can be opened.

- Open the door and add or remove laundry.
- Close the door.
- Touch the Start/Add laundry sensor control.

The programme will continue.

Laundry cannot usually be added or removed if:

- The suds temperature is above 55 °C
- The water inside the drum is above a certain level

## Cleaning and care

### Cleaning the external casing and the control panel

- Clean the casing and control panel with a mild cleaning agent or soap and water and dry both with a soft cloth.
- The drum can be cleaned using a suitable stainless steel cleaning agent following the manufacturer's instructions on the packaging.

## Cleaning the detergent dispenser drawer

- For hygiene reasons, clean the entire drawer at regular intervals.

### Removing the dispenser drawer

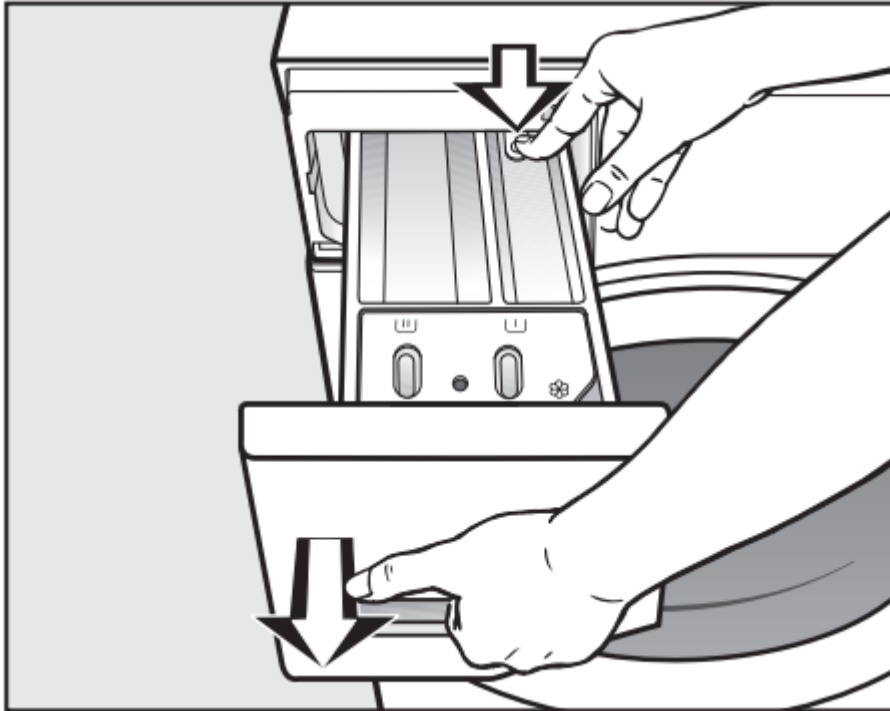

- Pull out the detergent dispenser drawer until a resistance is felt. Press down the release button and at the same time pull the drawer right out of the machine.
- Clean the detergent drawer with warm water.

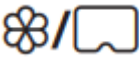
Cleaning the siphon and the  compartment channel

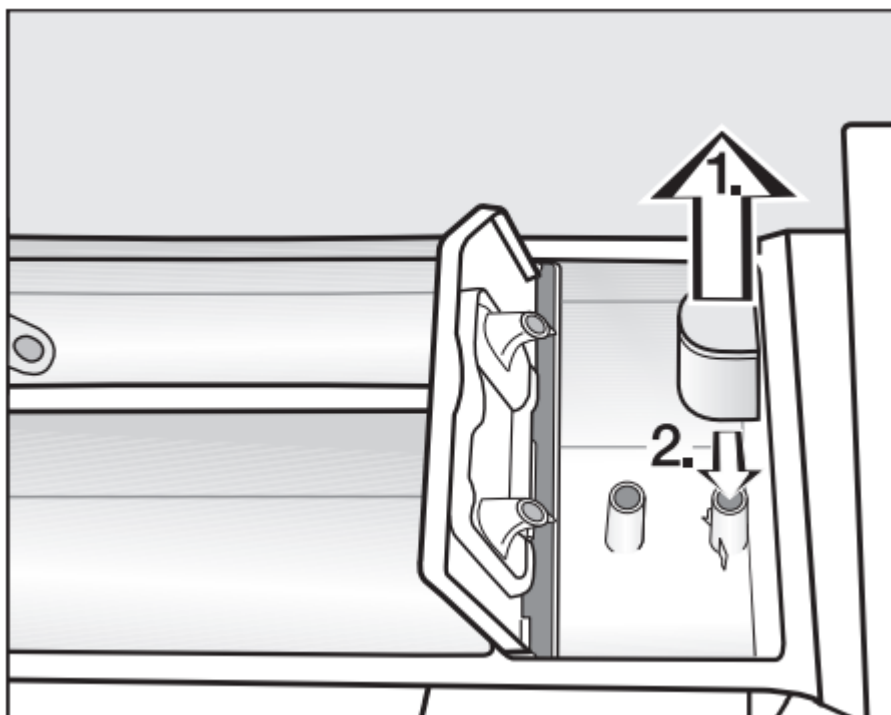

1. Remove the siphon from  compartment and clean under warm running water. Clean the siphon tube in the same way.
2. Replace the siphon.

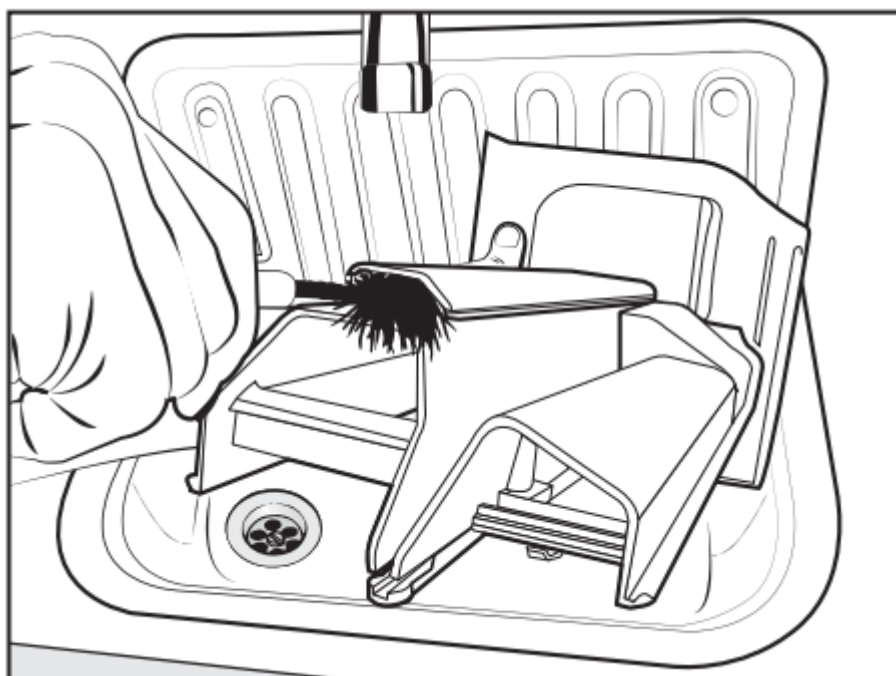

- Clean the fabric conditioner channel using a brush and warm water.

### **Cleaning the detergent dispenser drawer compartment**

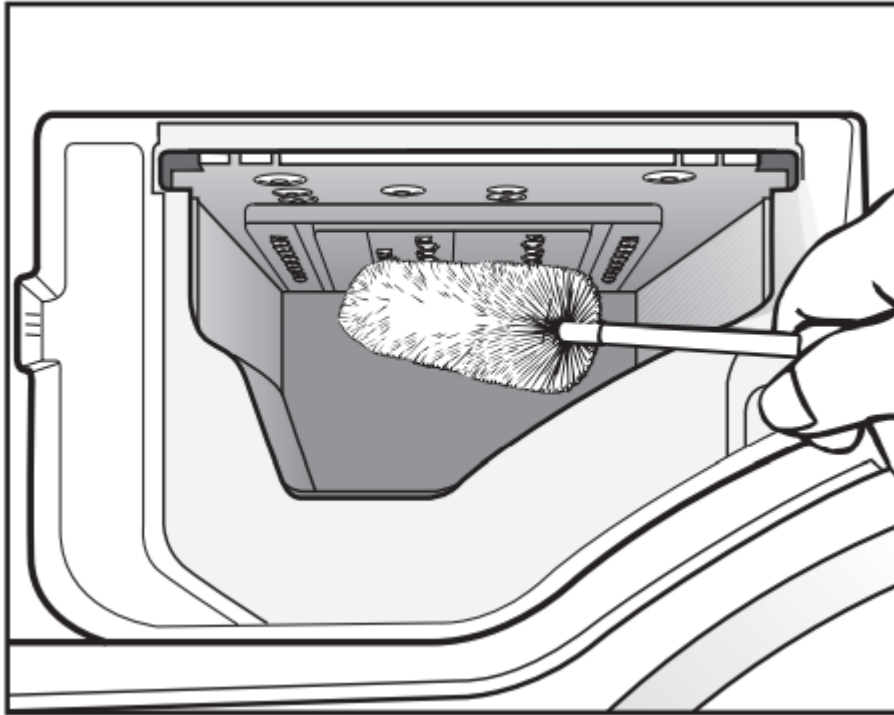

- Use a bottle brush to remove detergent residues and limescale from the jets inside the detergent dispenser drawer compartment.
- Replace the detergent dispenser drawer.

### Hygiene info (Cleaning the drum)

Washing at low temperatures and/or using liquid detergent can cause bacteria and unpleasant odours to build up in the washing machine. Use the Cottons 90 °C programme to clean the washing machine. Clean the drum when the indicator light  comes on at the latest.

### Cleaning the water inlet filter

The washing machine has 2 filters to protect the inlet valve. Check these filters every 6 months or so. Perform this check more often if there are frequent interruptions to the external water supply.

#### Cleaning the filter in the inlet hose

- First turn off the stopcock.
- Unscrew the inlet hose from the stopcock.

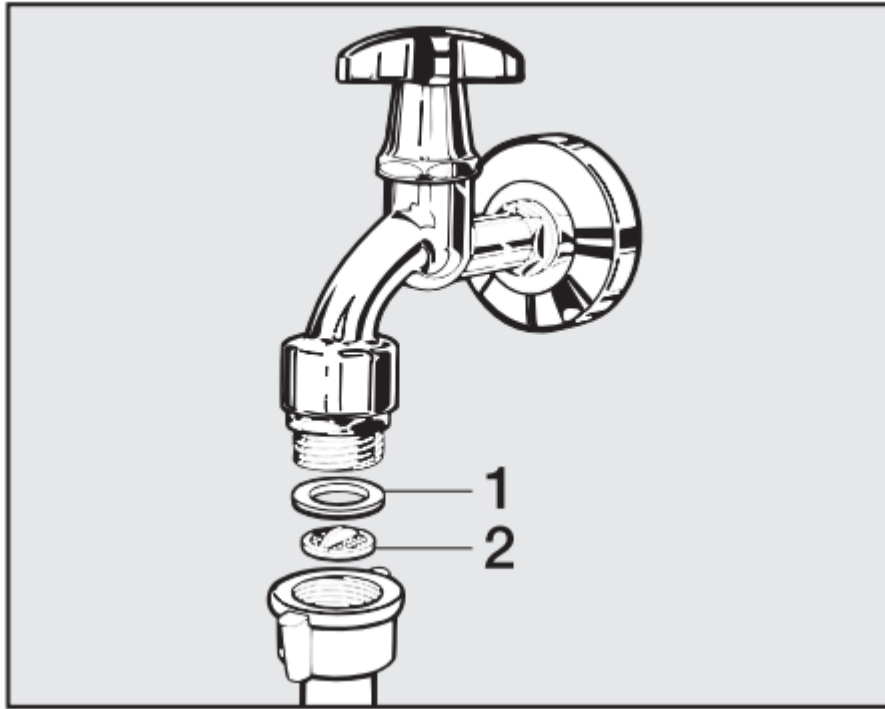

- Remove the rubber seal 1 from the recess.
- Using pointed pliers, take hold of the plastic filter slat 2 and remove the plastic filter.
- Clean the filter.
- Reassemble in reverse order.

#### **Cleaning the filter in the inlet valve**

- Using pliers, carefully loosen the ribbed plastic nut on the inlet valve and unscrew it.

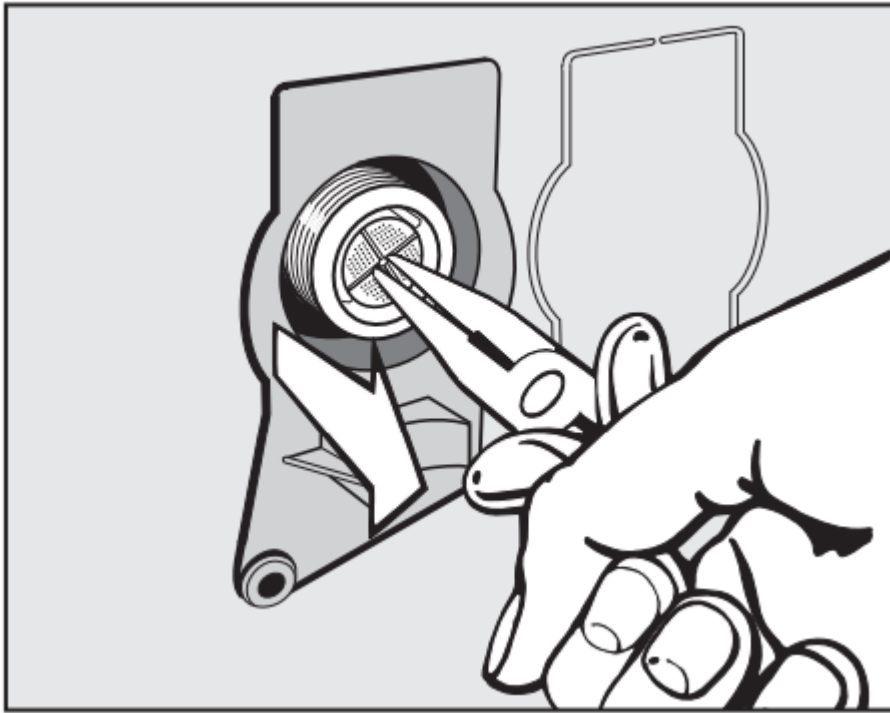

- Use pointed pliers to withdraw the plastic filter by the slat.
- Clean the filter
- Reassemble in reverse order.
- Screw the screw connection securely back onto the stopcock.
- Open the stopcock.

### **Problem solving guide**

Many malfunctions and faults that can occur in daily operation can be easily remedied. Time and money will be saved because a service call will not be needed.



The following guide may help you to find the reason for a malfunction or a fault, and to correct it.

## The programme does not start

Problem	Cause and remedy
The control panel remains dark.	<p>There is no power to the machine.</p> <ul style="list-style-type: none"><li>▪ Check whether the mains plug is plugged in and switched on.</li><li>▪ Check whether the fuse or circuit breaker has tripped</li></ul> <p>The washing machine has switched off automatically to save energy.</p> <ul style="list-style-type: none"><li>▪ Switch the washing machine on again by turning the programme selector.</li></ul>
<i>F</i> and <i>34</i> alternately appear in the time display	<p>The door is not closed properly. The door lock could not engage.</p> <ul style="list-style-type: none"><li>▪ Close the door again.</li><li>▪ Start the programme again.</li></ul> <p>If the fault message appears again, contact the Service Department.</p>

**The programme is cancelled and a fault indicator light lights up in the control panel**





Problem	Cause and remedy
<p>The fault indicator light  lights up, <b>F</b> and <b>  </b> appear alternately in the time display and the buzzer sounds</p>	<p>The water outlet is blocked or restricted.</p> <p>The drain hose has been fixed too high.</p> <ul style="list-style-type: none"> <li>▪ Clean the drain filter and the drain pump.</li> <li>▪ The maximum delivery head is 1 m.</li> </ul>
<p>The fault indicator light  lights up, <b>F</b> and <b>10</b> appear alternately in the time display and the buzzer sounds.</p>	<p>The water inlet is blocked or restricted.</p> <ul style="list-style-type: none"> <li>▪ Check whether the stopcock is opened properly.</li> <li>▪ Check whether the inlet hose is kinked.</li> <li>▪ Check whether the water pressure is too low.</li> </ul> <p>The filter in the water inlet is blocked.</p> <ul style="list-style-type: none"> <li>▪ Clean the filter.</li> </ul>
<p>The fault indicator light  lights up, <b>F</b> and <b>138</b> appear alternately in the time display and the buzzer sounds.</p>	<p>The water protection system has reacted.</p> <ul style="list-style-type: none"> <li>▪ Close the stopcock.</li> <li>▪ Call the Service Department.</li> </ul>
<p><b>F</b> and <b>XXX</b> appear alternately on the time display and the buzzer sounds.</p>	<p>There is a fault.</p> <ul style="list-style-type: none"> <li>▪ Disconnect the washing machine from the electricity supply. Switch off at the wall and withdraw the plug from the socket, or disconnect the fuse.</li> <li>▪ Wait at least 2 minutes before reconnecting the washing machine to the electricity supply.</li> <li>▪ Switch the washing machine on again.</li> <li>▪ Restart the programme.</li> </ul> <p>If the fault message appears again, contact the Miele Customer Service Department.</p>

## During the programme, a symbol appears in the time display

Message	Cause and remedy
 lights up	<p>The programme selector was moved to a different position after the programme had started.</p> <ul style="list-style-type: none"> <li>▪ Turn the programme selector back to the original position.</li> </ul>



## At the end of the programme, an indicator light lights up in the control panel

Problem	Cause and remedy
The indicator light  lights up.	<p>Excessive foam has built up during washing.</p> <ul style="list-style-type: none"> <li>▪ Use less detergent next time, and follow the manufacturer's recommended dosage amounts on the packaging.</li> </ul>
The indicator light  lights up.	<p>When washing, a wash programme using a temperature above 60 °C has not been run for a long time.</p> <ul style="list-style-type: none"> <li>▪ Run the Cottons 90 °C programme using Miele machine cleaner or a universal powder detergent.</li> </ul> <p>This will clean the washing machine and prevent a build-up of bacteria and odours.</p>
<i>F</i> and <i>37</i> appear alternately on the time display.	<p>The Pre-ironing extra which runs at the end of the programme could not be carried out properly.</p> <ul style="list-style-type: none"> <li>▪ Check whether the washing machine is aligned correctly (see "Installation – Levelling the machine").</li> <li>▪ Check whether the maximum drainage head height of 1 m has been exceeded.</li> </ul> <p>If the fault message appears again, contact the Miele Customer Service Department. The washing machine can still be used, but without the Pre-ironing extra.</p>

## General problems with the washing machine



Problem	Cause and remedy
<p>The washing machine smells.</p>	<p>The  indicator light was ignored. A wash programme using a temperature above 60 °C has not been run for a long time.</p> <ul style="list-style-type: none"> <li>▪ In order to prevent bacteria and unpleasant odours building up in the washing machine, run the Cottons 90 °C programme using Miele machine cleaner or a universal powder detergent.</li> </ul> <p>The door and the detergent dispenser drawer were left shut after washing.</p> <ul style="list-style-type: none"> <li>▪ Leave the door and the detergent dispenser drawer slightly open to allow them to dry.</li> </ul>
<p>The machine shakes during the spin cycle</p>	<p>The machine feet are not level.</p> <ul style="list-style-type: none"> <li>▪ Level the machine and adjust the feet correctly.</li> </ul>
<p>The laundry has not been spun properly and is still wet.</p>	<p>The machine detected an imbalance during the final spin cycle and reduced the spin speed automatically.</p> <ul style="list-style-type: none"> <li>▪ Include both large and small items in the load as this will give better distribution during spinning.</li> </ul>
<p>Strange pump noises can be heard.</p>	<p>This is not a fault.</p> <p>These slurping noises occur at the end of the pump sequence as a normal part of operation.</p>
<p>Large amounts of detergent residue remain in the detergent dispenser drawer.</p>	<p>The water pressure is too low.</p> <ul style="list-style-type: none"> <li>▪ Clean the water inlet filter.</li> <li>▪ It may be useful to select the Water + extra option.</li> </ul>

	<p>Powder detergent used in conjunction with water softeners tends to become sticky.</p> <ul style="list-style-type: none"> <li>▪ In future, add washing powder into the dispenser drawer first, and then add the water softener.</li> </ul>
<p>Fabric conditioner is not completely dispensed or too much water remains in the  compartment.</p>	<p>The siphon tube is not correctly positioned or is clogged.</p> <ul style="list-style-type: none"> <li>▪ Clean the siphon, see “Cleaning and care - Cleaning the detergent dispenser drawer”.</li> </ul>
<p>At the end of the programme there is still liquid in the capsule.</p>	<p>The small pipe in the detergent dispenser drawer onto which the capsule is placed is blocked.</p> <ul style="list-style-type: none"> <li>▪ Clean the small pipe.</li> </ul> <p>This is not a fault.</p> <p>For technical reasons a small amount of water will remain in the capsule.</p>
<p>There is water next to the capsule in the fabric conditioner compartment</p>	<p>The  sensor control was not activated.</p> <ul style="list-style-type: none"> <li>▪ Make sure that you remember to activate the  sensor control the next time you insert a capsule.</li> </ul> <p>An empty capsule was not removed at the end of the last wash programme.</p> <ul style="list-style-type: none"> <li>▪ Remove and dispose of the empty capsule at the end of each programme.</li> </ul> <p>There is a blockage in the small pipe in the detergent drawer onto which the capsule is placed.</p> <ul style="list-style-type: none"> <li>▪ Clean the small pipe.</li> </ul>

## An unsatisfactory wash result

Problem	Cause and remedy
<p>Liquid detergent does not give the required result.</p>	<p>Liquid detergents usually contain no bleaching agents. They do not remove fruit, coffee and tea stains.</p> <ul style="list-style-type: none"> <li>▪ Use a general purpose powder detergent containing a bleaching agent.</li> <li>▪ Use the appropriate capsule or add stain removers to the  compartment.</li> <li>▪ Never put stain removers and liquid detergent together in the dispenser drawer.</li> </ul>
<p>Grey, greasy particles cling to washed laundry</p>	<p>Insufficient amounts of detergent were used to break down the particles of grease in heavily soiled laundry.</p> <ul style="list-style-type: none"> <li>▪ Use more detergent.</li> <li>▪ Before washing the next load run a Cottons 60°C programme with powder detergent but without a load.</li> </ul>
<p>White residues which look like powder detergent are seen on dark textiles after washing.</p>	<p>The detergent contained compounds (zeolites) to aid water softening which are not soluble in water. These have ended up on the laundry.</p> <ul style="list-style-type: none"> <li>▪ Try and brush off the residues with a soft brush once the laundry is dry.</li> <li>▪ Wash dark textiles using a detergent which contains no zeolites. Liquid detergents usually contain no zeolites.</li> <li>▪ Use the Dark garments/Denim programme for dark coloured laundry.</li> </ul>

## The door will not open

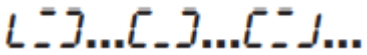
Problem	Cause and remedy
<p>The door cannot be pulled open during a programme.</p>	<p>The drum is locked during a programme.</p> <ul style="list-style-type: none"> <li>▪ Follow the description in “5. Starting a programme – Adding or removing laundry”.</li> </ul>
<p>After the programme is cancelled, flashing bars  appear in the time display.</p>	<p>For safety reasons the drum door cannot be opened if the suds temperature is higher than 55 °C.</p> <ul style="list-style-type: none"> <li>▪ Wait until the temperature in the drum has decreased and the bars have stopped flashing in the display.</li> </ul>
<p><i>F</i> and <i>35</i> alternately appear in the time display.</p>	<p>The door lock has jammed.</p> <ul style="list-style-type: none"> <li>▪ Call the Service Department.</li> </ul>

## Opening the door in the event of a blocked drain outlet and/ or power cut

- Switch off the washing machine.

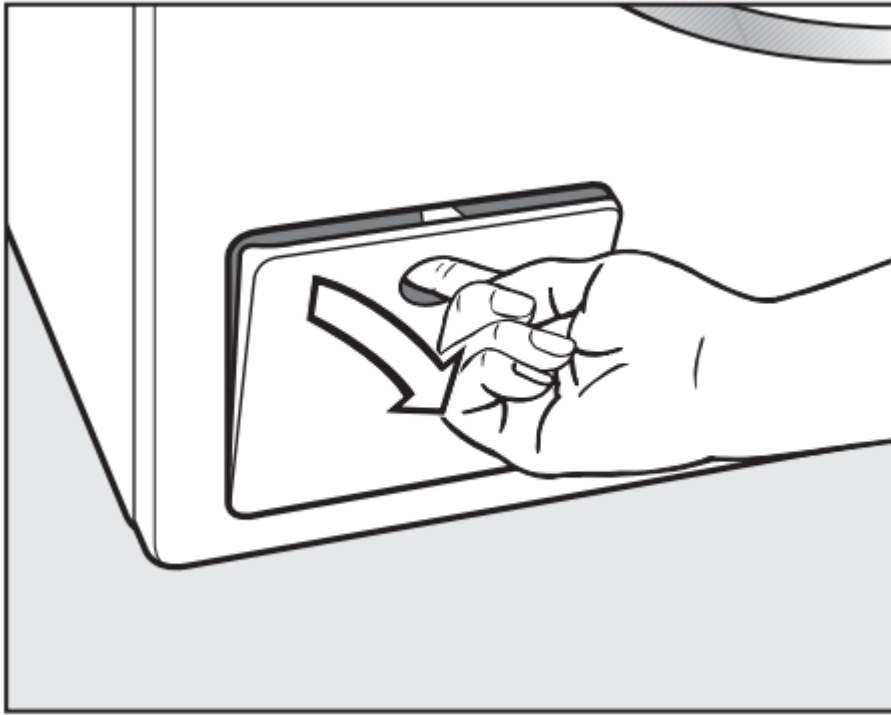

- Open the drain pump access panel.

#### **Blocked drain outlet**

If the drain outlet is blocked, there may be a large quantity of water left behind in the washing machine.

#### **Draining the washing machine**

- Place a suitable container under the access panel, e.g. a universal oven tray

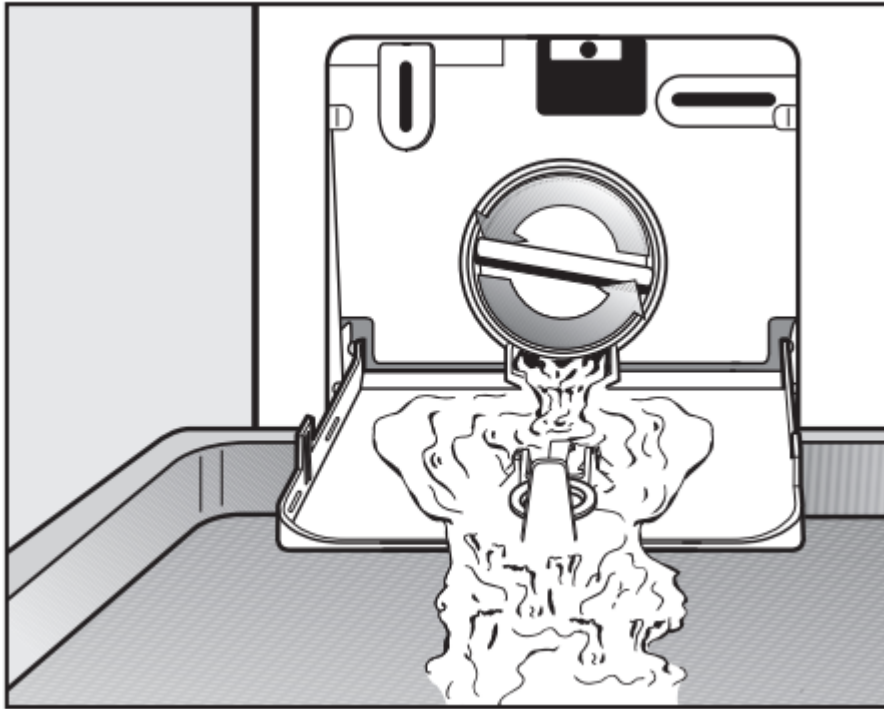

- Slowly unscrew the drain filter to let the water out.
- Tighten the drain filter back up again if you need to interrupt the flow of water.

Once the flow of water ceases:

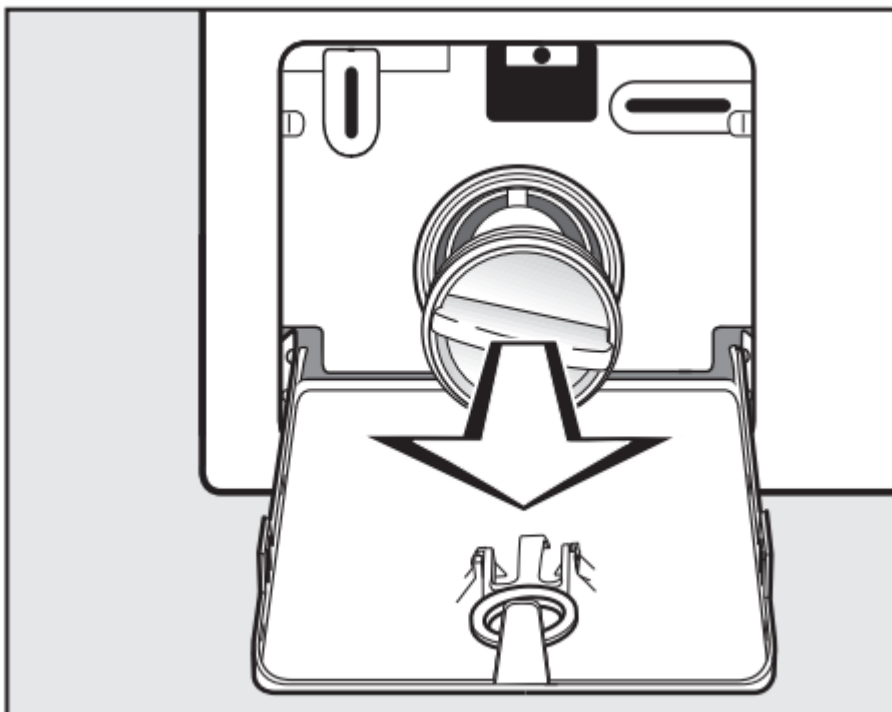

- Remove the drain filter completely.

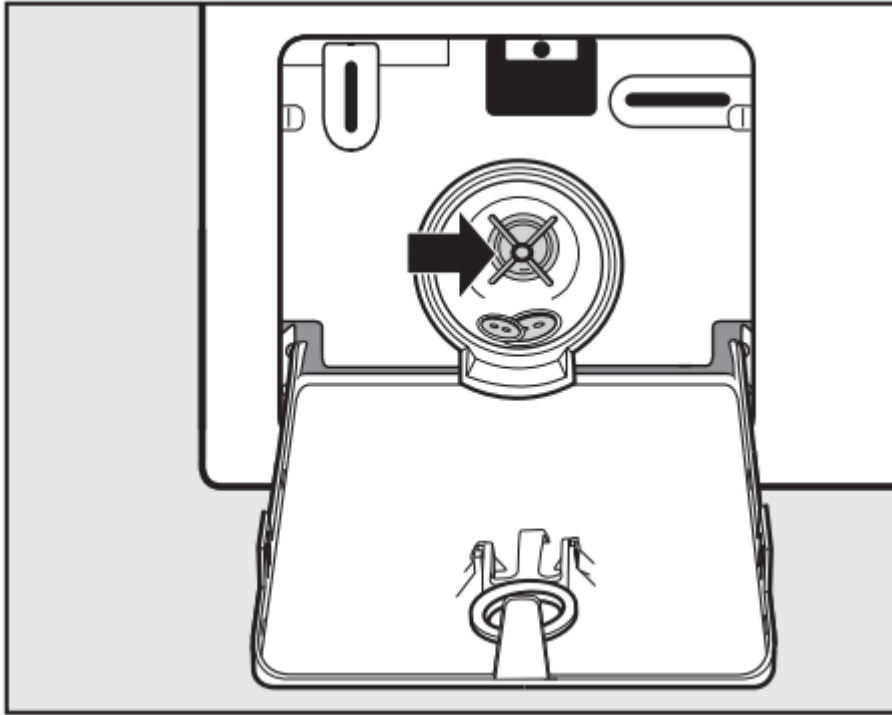

- Clean the drain filter thoroughly.
- Remove any foreign objects (e.g., buttons, coins etc.) and clean the interior. Turn the impellers by hand to check that they rotate freely.
- Replace the drain filter correctly and tighten it securely.
- Close the drain pump access panel.

### **Open the door**

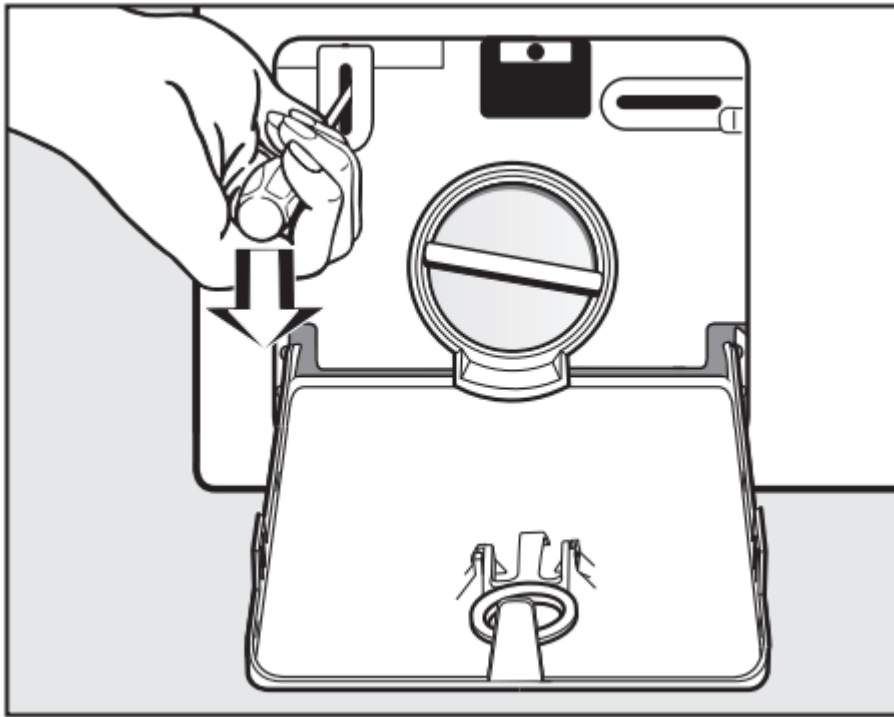

- Use a screwdriver to unlock the door.
- Pull open the door.

## Technical data

Height	850 mm
Width	596 mm
Depth	643 mm
Depth with door open	1077 mm
Height for building under	850 mm
Width for building under	600 mm
Weight	Approx. 96 kg
Capacity	8 kg dry laundry
Voltage	See data plate
Connected load	See data plate
Fuse rating	See data plate
Consumption data	See "Consumption data"
Minimum flow pressure	100 kPa
Maximum flow pressure	1000 kPa
Inlet hose length	1.60 m
Drain hose length	1.50 m
Mains connection cable length	2.00 m
Delivery head max.	1.00 m
Maximum drainage length	5.00 m
LEDs	Class 1
Test certificates awarded	See data plate

### Warning

This content is compiled from multiple sources and is provided for reference purposes only. It may not be complete or fully applicable to all situations. If you are unable to resolve your issue, please contact the product manufacturer or an authorized service provider for official support.