

## 1. Safety warnings

### 1.1 Warning

Warning: risk of fire / flammable materials RECOMMENDATIONS:

This appliance is intended to be used in household and similar applications such as staff kitchen areas in shops, offices and other working environments; farm houses and by clients in hotels, motels and other residential type environments; bed and breakfast type environments; catering and similar non- retail applications.

If the supply cord is damaged, it must be replaced by the manufacturer, its service agent or similarly qualified persons in order to avoid a hazard.

Do not store explosive substances such as aerosol cans with a flammable propellant in this appliance. The appliance has to be unplugged after use and before carrying out user maintenance on the appliance.

**WARNING:** Keep ventilation openings, in the appliance enclosure or in the built- in structure, clear of obstruction.

**WARNING:** Do not use mechanical devices or other means to accelerate the defrosting process, other than those recommended by the manufacturer.

WARNING: Do not damage the refrigerant circuit.

WARNING: Do not use electrical appliances inside the food storage compartments of the appliance, unless they are of the type recommended by the manufacturer.

WARNING: Please abandon the freezer according to local regulators for its use of flammable blowing gas and refrigerant.

WARNING: When positioning the appliance, ensure the supply cord is not trapped or damaged.

WARNING: Do not locate multiple portable socket-outlets or portable power supplies at the rear of the appliance.

Do not use extension cords or ungrounded (two prong) adapters.

DANGER: Risk of child entrapment. Before you throw away your old freezer:

- Take off the doors.
- Leave the shelves in place so that children may not easily climb inside.

The freezer must be disconnected from the source of electrical supply before attempting the installation of accessory.

Refrigerant and cyclopentane foaming material used for the freezer are flammable. Therefore, when the freezer is scrapped, it shall be kept away from any fire source and be recovered by a special recovering company with corresponding qualification other than be disposed by combustion, so as to prevent damage to the environment or any other harm.

WARNING: Refrigerant and flammable blowing gas must be removed before disposal according to federal and local regulations; It is the consumer's responsibility to comply with federal and local regulations when disposing of this product.

This appliance is not intended for use by persons (including children) with reduced physical, sensory or mental capabilities, or lack of experience, knowledge, unless they have been given supervision or instruction concerning use of the appliance by a person responsible for their safety.

Children should be supervised to ensure that they do not play with the appliance.

## 1.2 Meaning of safety warning symbols

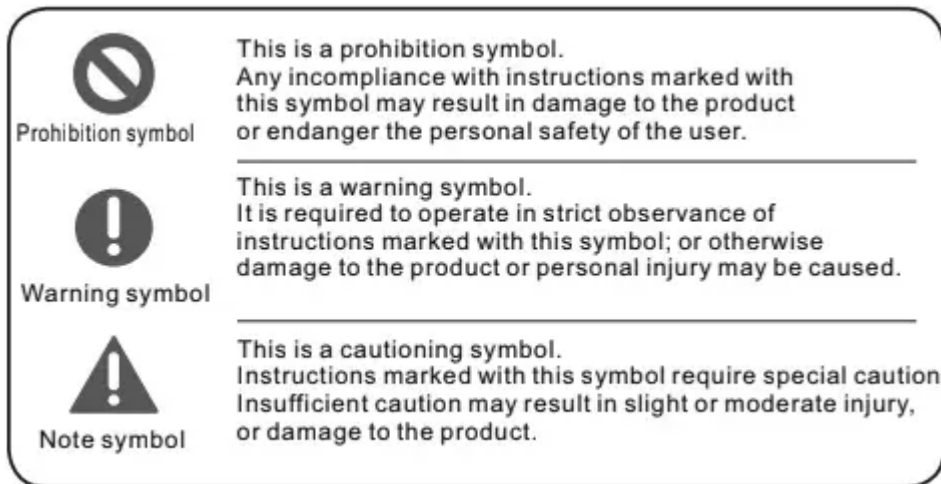

This manual contains lots of important safety information which shall be observed by the users.

## 1.3 Electricity related warnings

[IMAGE]

Do not pull the power cord when pulling the power plug of the freezer. Please firmly grasp the plug and pull out it from the socket directly. To ensure safe use, do not damage the power cord or use the power cord when it is damaged or worn.

Please use a dedicated power socket and the power socket shall not be shared with other electrical appliances. The power plug should be firmly contacted with the socket or else fires might be caused. Please ensure that the grounding electrode of the power socket is equipped with a reliable grounding line.

Please turn off the valve of the leaking gas and then open the doors and windows in case of leakage of gas and other flammable gases. Do not unplug the freezer and other electrical appliances considering that spark may cause a fire.

Do not use electrical appliances on the top of the appliance, unless they are of the type recommended by the manufacturer.

## 1.4 Warnings for using

Do not arbitrarily disassemble or reconstruct the freezer, nor damage the refrigerant circuit; maintenance of the appliance must be conducted by a specialist. Damaged power cord must be replaced by the manufacturer, its maintenance department or related professionals in order to avoid danger.

The gaps between freezer doors and between doors and freezer body are small, be noted not to put your hand in these areas to prevent from squeezing the finger. Please be gentle when close the freezer door to avoid falling articles.

Do not pick foods or containers with wet hands in the freezing chamber when the freezer is running, especially metal containers in order to avoid frostbite. Do not allow any child to get into or climb the freezer; otherwise suffocation or falling injury of the child may be caused.

Do not place heavy objects on the top of the freezer considering that objects may fall when close or open the door, and accidental injuries might be caused. Please pull out the plug in case of power failure or cleaning.

Do not connect the freezer to power supply within five minutes to prevent damages to the compressor due to successive starts.

### **1.5 Warnings for placement**

Do not put flammable, explosive, volatile and highly corrosive items in the freezer to prevent damages to the product or fire accidents.

Do not place flammable items near the freezer to avoid fires. The freezer is intended for household use, such as storage of foods; it shall not be used for other purposes, such as storage of blood, drugs or biological products, etc.

Do not store beer, beverage or other fluid contained in bottles or enclosed containers in the freezing chamber of the freezer; or otherwise the bottles or enclosed containers may crack due to freezing to cause damages.

### **1.6 Warnings for energy**

Warning for energy

- 1) Refrigerating appliances might not operate consistently (possibility of defrosting of contents or temperature becoming too warm in the frozen food compartment) when sited for an extended period of time below the cold end of the range of temperatures for which the refrigerating appliance is designed.
- 2) The fact that effervescent drinks should not be stored in food freezer compartments or cabinets or in low-temperature compartments or cabinets, and that some products such as water ices should not be consumed too cold;
- 3) The need to not exceed the storage time(s) recommended by the food manufacturers for any kind of food and particularly for commercially quick-frozen food in food-freezer and frozen-food storage compartments or cabinets;
- 4) The precautions necessary to prevent an undue rise in the temperature of the frozen food while defrosting the refrigerating appliance, such as wrapping the frozen food in several layers of newspaper.
- 5) The fact that a rise in temperature of the frozen food during manual defrosting, maintenance or cleaning could shorten the storage life.

6) The necessity that, for doors or lids fitted with locks and keys, the keys be kept out of the reach of children and not in the vicinity of the refrigerating appliance, in order to prevent children from being locked inside.

## **1.7 Warnings for disposal**

Refrigerant and cyclopentane foaming material used for the freezer are flammable. Therefore, when the freezer is scrapped, it shall be kept away from any fire source and be recovered by a special recovering company with corresponding qualification other than be disposed by combustion, so as to prevent damage to the environment or any other harm.

When the freezer is scrapped, disassemble the doors, and remove gasket of door and shelves; put the doors and shelves in a proper place, so as to prevent trapping of any child.

Correct Disposal of this product:

This marking indicates that this product should not be disposed with other household wastes throughout the EU. To prevent possible harm to the environment or human health from uncontrolled waste disposal, recycle it responsibly to promote the sustainable reuse of material resources. To return your used device, please use the return and collection systems or contact the retailer where the product was purchased. They can take this product for environmental safe recycling.

## **2. Proper use of the freezer**

### **2.1 Placement**

Before use, remove all packing materials, including bottom cushions, foam pads and tapes inside of the freezer; tear off the protective film on the doors and the freezer body.

Keep away from heat and avoid direct sunlight. Do not place the freezer in moist or watery places to prevent rust or reduction of insulating effect.

Do not spray or wash the freezer; do not put the freezer in moist places easy to be splashed with water so as not to affect the electrical insulation properties of the freezer.

The freezer is placed in a well- ventilated indoor place; the ground shall be flat, and sturdy (rotate left or right to adjust the wheel for levelling if unstable).

The top space of the freezer shall be greater than 30cm, and The freezer should be placed against a wall with a free distance more than 10cm to facilitate heat dissipation.

Precautions before installation: Before installation or adjusting of accessories, it shall be ensured that the freezer is disconnected from power. Precautions shall be taken to prevent fall of the handle from causing any personal injury.

## 2.2 Levelling feet

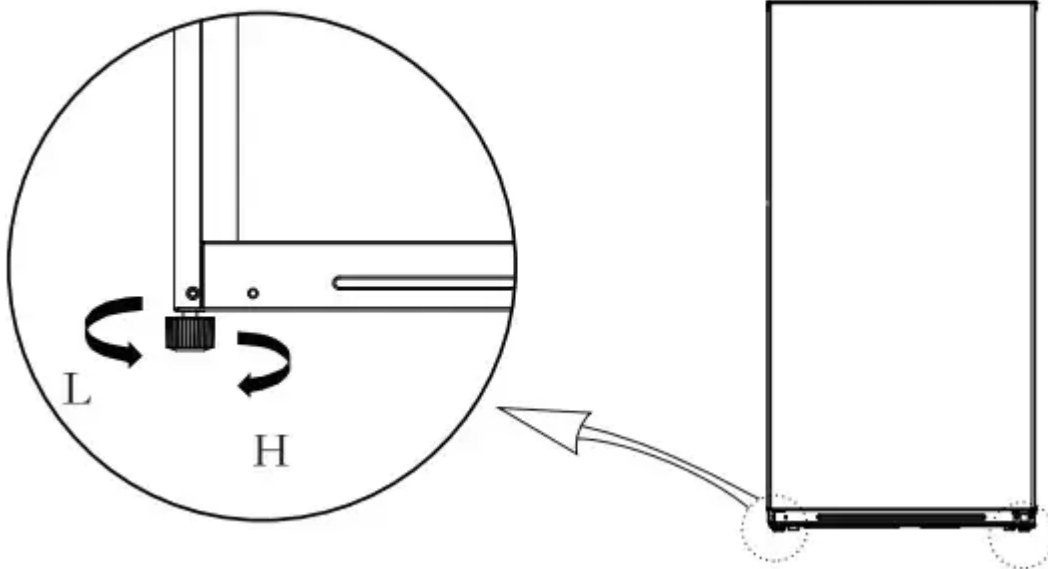

Schematic diagram of the levelling feet (The picture above is only for reference. The actual configuration will depend on the physical product or statement by the distributor.) Adjusting procedures:

- a. Turn the feet clockwise to raise the freezer;
- b. Turn the feet counterclockwise to lower the freezer;
- c. Adjust the right and left feet based on the procedures above to a horizontal level.

## 2.3 Changing the Light

Any replacement or maintenance of the LED lamps is intended to be made by the manufacturer, its service agent or similar qualified person.

## 2.4 Starting

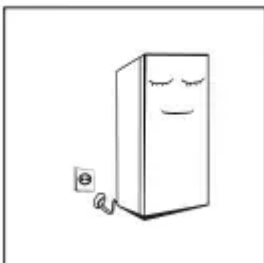

Before initial start, keep the freezer still for half an hour before connecting it to power supply.

Before putting any fresh or frozen foods, the freezer shall have run for 2- 3 hours, or for above 4 hours in summer when the ambient temperature is high.

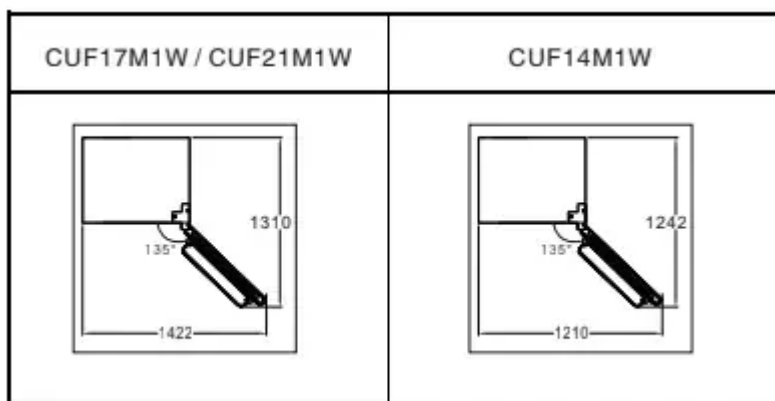

Spare enough space for convenient opening of the doors and drawers or statement by the distributor. The picture above is only for reference.

The actual configuration will depend on the physical product or statement by the distributor

## 2.5 Energy saving tips

- The appliance should be located in the coolest area of the room, away from heat producing appliances or heating ducts, and out of the direct sunlight.
- Let hot foods cool to room temperature before placing in the appliance. Overloading the appliance forces the compressor to run longer. Foods that freeze too slowly may lose quality, or spoil.
- Be sure to wrap foods properly, and wipe containers dry before placing them in the appliance. This cuts down on frost build- up inside the appliance.
- Appliance storage bin should not be lined with aluminum foil, wax paper, or paper toweling. Liners interfere with cold air circulation, making the appliance less efficient.
- Organize and label food to reduce door openings and extended searches. Remove as many items as needed at one time, and close the door as soon as possible.

### 3. Structure and functions

#### 3.1 Key components

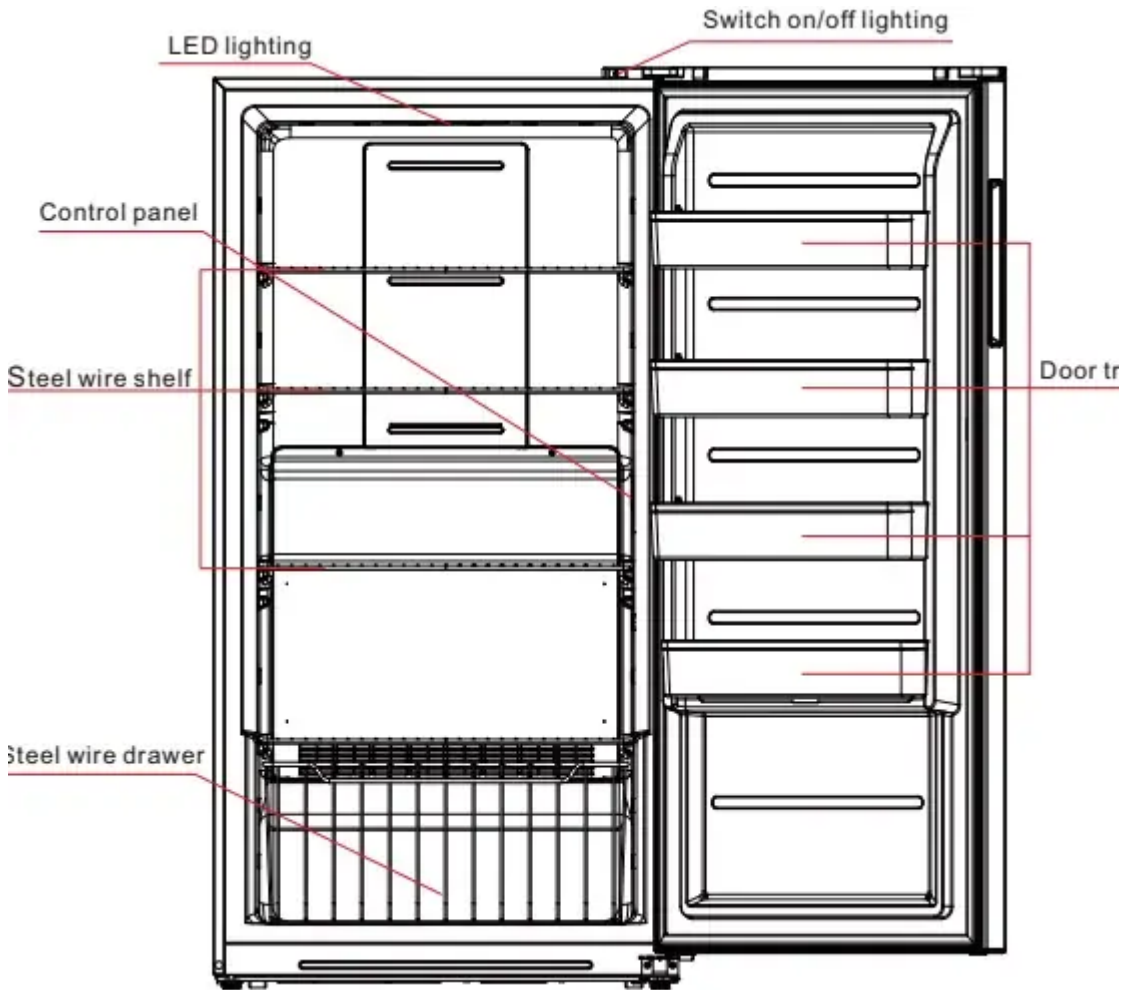

(The picture above is only for reference. The actual configuration will depend on the physical product or statement by the distributor.)

#### Freezing chamber

The low temperature freezing chamber may keep food fresh for a long time and it is mainly used to store frozen foods and making ice.

The freezing chamber is suitable for storage of meat, fish, rice balls and other foods not to be consumed in short term.

Chunks of meat are preferably to be divided into small pieces for easy access. Please be noted food shall be consumed within the shelf time.

Note: Storage of too much food during operation after the initial connection to power may adversely affect the freezing effect of the freezer. Foods stored shall not block the air outlet; or otherwise the freezing effect will also be adversely affected.

### 3.2 Functions

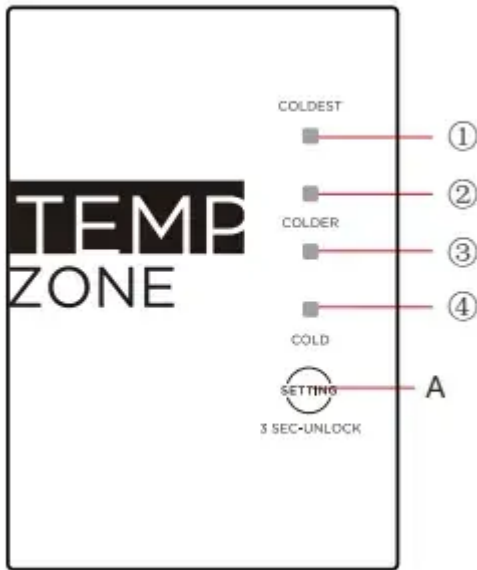

(The picture above is only for reference. The actual configuration will depend on the physical product or statement by the distributor)

- 1) Key A. Set key
- 2) Display screen

1)setting 1:COLDEST 2) \(\circledcirc\) setting 2 & 3:COLDER 4)setting 4:COLD 3)

Display

Once initially powered on, the display screen is on full display for 3s.

Normal operation display.

In case of a failure, the corresponding LED blinks.

In case of no failures, it shows the actual temperature setting of freezer.

Fault Code	Fault Description
indicator ③ and ④	Freezer sensor circuit
indicator ② and ④	Freezer defrost sensor
indicator ① and ④	Ambient temperature sensor

#### 4) Temperature setting

Each time the temperature setting button A is pressed once, the temperature setting changes one time. When temperature set at COLDER setting, 2 LED lights in the middle blink simultaneously.

After the temperature setting has been completed, the freezer will run according to the set value after 15s.

The shift regulation is:



#### 5) Lock/Unlock

When the temperature control panel is in lock state, it needs to long press temperature setting key for 3 seconds for unlocking the panel, all LEDs will blink for 2 second when panel is unlocked.

When the temperature control panel is in unlock state, if there is no operation on control panel within 30 seconds, it will enter into lock state automatically.

## 4. Maintenance and care of the freezer

### 4.1 Overall cleaning

- Dusts behind the freezer and on the ground shall be timely cleaned to improve the cooling effect and energy saving.
- Check the door gasket regularly to make sure there are no debris. Clean the door gasket with a soft cloth dampened with soapy water or diluted detergent. - The interior of the freezer should be cleaned regularly to avoid odor.
- Please turn off the power before cleaning interior, remove all foods, drinks, shelves, drawers, etc.
- Use a soft cloth or sponge to clean the inside of the freezer, with two tablespoons of baking soda and a quart of warm water. Then rinse with water and wipe clean. After cleaning, open the door and let it dry naturally before turning on the power.
- For areas that are difficult to clean in the freezer (such as narrow sandwiches, gaps or corners), it is recommended to wipe them regularly with a soft rag, soft brush, etc. and when necessary, combined with some auxiliary tools (such as thin sticks) to ensure no contaminants or bacterials accumulation in these areas.
- Do not use soap, detergent, scrub powder, spray cleaner, etc., as these may cause odors in the interior of the freezer or contaminated food.
- Clean the bottle frame, shelves and drawers with a soft cloth dampened with soapy water or diluted detergent. Dry with a soft cloth or dry naturally.
- Wipe the outer surface of the freezer with a soft cloth dampened with soapy water, detergent, etc., and then wipe dry.
- Do not use hard brushes, clean steel balls, wire brushes, abrasives (such as toothpastes), organic solvents (such as alcohol, acetone, banana oil, etc.), boiling water, acid or alkaline items,

which may damage the fridge surface and interior. Boiling water and organic solvents such as benzene may deform or damage plastic parts.

- Do not rinse directly with water or other liquids during cleaning to avoid short circuits or affect electrical insulation after immersion.

#### 4.2 Cleaning of door tray

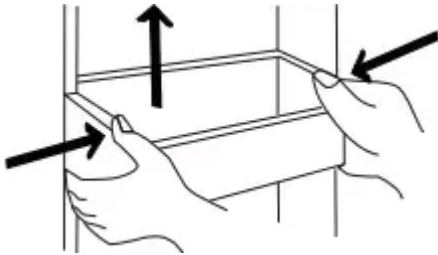

(The picture above is only for reference. The actual configuration will depend on the physical product or statement by the distributor.) According to the direction arrow in the figure below, use both hands to squeeze the tray, and push it upward, then you can take it out. After washing the tray having been taken out, you can adjust its installing height in accordance with your requirement.

#### 4.3 Defrosting

The freezer is made based on the air-cooling principle and thus has automatic defrosting function. Frost formed due to change of season or temperature may also be manually removed by disconnection of the appliance from power supply or by wiping with a dry towel.

#### 4.4 Out of operation

Power failure: In case of power failure, even if it is in summer, foods inside the appliance can be kept for several hours; during the power failure, the times of door opening shall be reduced, and no more fresh food shall be put into the appliance.

Long-time nonuse: The appliance shall be unplugged and then cleaned; then the doors are left open to prevent odor.

Moving: Before the freezer is moved, take all objects inside out, fix the glass partitions, vegetable holder, freezing chamber drawers and etc. with tape, and tighten the levelling feet; close the doors and fix them with tape. During moving, the appliance shall not be laid upside down or horizontally, or be vibrated; the inclination during movement shall be no more than  $(45^{\circ})$ . The appliance shall run continuously once it is started. Generally, the operation of the appliance shall not be interrupted; otherwise the service life may be impaired.

## **5. Trouble shooting**

### **5.1 Trouble shooting**

You may try to solve the following simple problems by yourself. If them cannot be solved, please contact the after- sales department.

<b>Problem</b>	<b>Check/Solution</b>
Failed operation	<p>Check whether the appliance is connected to power or whether the plug is in well contact</p> <p>Check whether the voltage is too low</p> <p>Check whether there is a power failure or partial circuits have tripped</p>
Odor	<p>Odorous foods shall be tightly wrapped</p> <p>Check whether there is any rotten food</p> <p>Clean the inside of the freezer</p>
Long-time operation of the compressor	<p>Long operation of the freezer is normal in summer when the ambient temperature is high</p> <p>It is not suggestible having too much food in the appliance at the same time</p> <p>Food shall get cool before being put into the appliance</p> <p>The doors are opened too frequently</p>
Light fails to get lit	<p>Check whether the freezer is connected to power supply and whether the illuminating light is damaged</p> <p>Have the light replaced by a specialist</p>
Doors cannot be properly closed	<p>The door is stuck by food packages</p> <p>Too much food is placed</p> <p>The freezer is tilted</p>
Loud noise	<p>Check whether the floor is level and whether the freezer is placed stably</p> <p>Check whether accessories are placed at proper locations</p>
Door seal fails to be tight	<p>Remove foreign matters on the door seal</p> <p>Heat the door seal and then cool it for restoration (or blow it with an electrical drier or use a hot towel for heating)</p>
Water pan overflows	<p>There is too much food in the chamber or food stored contains too much water, resulting in heavy defrosting</p> <p>The doors are not closed properly, resulting in frosting due to entry of air and increased water due to defrosting</p>
Hot housing	<p>Heat dissipation of the built-in condenser via the housing, which is normal</p> <p>When housing becomes hot due to high ambient temperature, storage of too much food or shutdown of the compressor is shut down, provide sound ventilation to facilitate heat dissipation</p>
Surface condensation	

	Condensation on the exterior surface and door seals of the freezer is normal when the ambient humidity is too high. Just wipe the condensate with a clean towel.
Abnormal noise	Buzz: The compressor may produce buzzes during operation, and the buzzes are loud particularly upon start or stop. This is normal. Creak: Refrigerant flowing inside of the appliance may produce creak, which is normal.

## Warranty

Your product is protected by this warranty: Warranty service must be obtained from Midea Consumer Services or an authorized Midea servicer.

### Warranty

One year full warranty from original purchase date, includes compressor, parts and labor only. Midea, through its authorized servicers will: Pay all costs for repairing or replacing parts of this appliance which prove to be defective in materials or workmanship.

### Midea is not responsible for:

Diagnostics, removal, transportation and reinstallation cost required because of service. Costs of service calls that are a result of items listed under NORMAL RESPONSIBILITIES OF THE CONSUMER\\\* Midea replacement parts shall be used and will be warranted only for the period remaining on the original warranty.

### NORMAL RESPONSIBILITIES OF THE CONSUMER\\\*

This warranty applies only to products in ordinary household use, and the consumer is responsible for the items listed below:

1. Proper use of the appliance in accordance with instructions provided with the product.
2. Routine maintenance and cleaning necessary to keep the good working condition.
3. Proper installation by an authorized service professional in accordance with instructions provided with the appliance and in accordance with all local plumbing, electrical and / or gas codes.
4. Proper connection to a grounded power supply of sufficient voltage, replacement of blown fuses, repair of loosened connections or defects in house wiring.
5. Expenses for making the appliance accessible for servicing.
6. Damages to finish after installation.

## **EXCLUSIONS**

This warranty does not cover the following:

1. Failure caused by damage to the unit while in your possession (other than damage caused by defect or malfunction), by its improper installation, or by unreasonable use of the product, including without limitation, failure to provide reasonable and necessary maintenance or to follow the written Installation and Operating Instructions.
2. Products purchased "as-is" or refurbished are not covered by this warranty.
3. Food loss caused by refrigerator or freezer failure.
4. Service calls to repair or replace consumables such as water filters, light bulbs air filters etc., or handles, knobs and other cosmetic parts.
5. Product that has been transferred from its original owner,
6. Interior or exterior rust on the unit.
7. Damages caused by services performed by persons other than authorized Midea servicers; use of parts other than Midea replacement parts; obtained from persons other than such Midea customer service; or external causes such as abuse, misuse, inadequate power supply or acts of God.
8. Service calls resulting from improper installation of your product.
9. Service calls to instruct you on the use of your product.
10. Surcharges including, but not limited to, any after hour, weekend, or holiday service calls, tolls, ferry trip charges, or mileage expense for service calls to remote areas, including the state of Alaska.
11. If the unit is put to commercial, business, rental, or other use or application other than for consumer use, we make no warranties, express or implied, including but not limited to, any implied warranty of merchantability or fitness for particular use or purpose.
12. Product that has been removed outside the USA or Canada.
13. Products without original serial numbers or products that have serial numbers which have been altered or cannot be readily determined. Note: Some states do not allow the exclusion or limitation of incidental or consequential damages. So this limitation or exclusion may not apply to you.

## **IF YOU NEED SERVICE**

Keep your bill of sale, delivery slip, and other appropriate payment record. The date on the bill established the warranty period should service be required. If service is performed, it is your best interest to obtain and keep all receipts. This written warranty gives you specific legal rights. You may also have other rights that vary from state to state. Service under this warranty must be obtained by following these steps, in order:

1. Contact Midea Consumer Services or an authorized Midea servicer at 1-866-646-4332
2. If there is a question as to where to obtain service, contact our consumer relations Department.

**Warning**

This content is compiled from multiple sources and is provided for reference purposes only. It may not be complete or fully applicable to all situations. If you are unable to resolve your issue, please contact the product manufacturer or an authorized service provider for official support.

---

Document generated by [ManualsFile](#)