

## Installation

- Do not place this apparatus near or over a radiator or heat register, or where it is exposed to direct sunlight.
- Do not place vessels (vases etc.) containing water on this apparatus, as this can result in a fire or electric shock
- Do not expose this apparatus to rain or moisture.
- Be sure to contact an authorised Samsung service centre for information if you intend to install your TV in a location with heavy dust, high or low temperatures, high humidity, chemical substances, or where it will operate 24 hours a day such as in an airport, a train station, etc. Failure to do so may lead to serious damage to your TV.
- Do not expose this apparatus to dripping or splashing.

### Mounting the TV on a wall



If you mount this TV on a wall, follow the instructions exactly as set out by the manufacturer. If it is not correctly mounted, the TV may slide or fall and cause serious injury to a child or adult and serious damage to the TV.

- To order the Samsung wall mount kit, contact Samsung service centre.
- Samsung is not responsible for any damage to the product or injury to yourself or others if you choose to install the wall mount on your own.
- Samsung is not liable for product damage or personal injury when a non-VESA or non-specified wall mount is used or when the consumer fails to follow the product installation instructions.
- You can install your wall mount on a solid wall perpendicular to the floor. Before attaching the wall mount to surfaces other than plaster board, contact your nearest dealer for additional information. If you install the TV on a ceiling or slanted wall, it may fall and result in severe personal injury.
- When installing a wall mount kit, we recommend you fasten all four VESA screws.
- If you want to install a wall mount kit that attaches to the wall using two top screws only, be sure to use a Samsung wall mount kit that supports this type of installation. (You may not be able to purchase this type of wall mount kit, depending on the geographical area.)
- Do not mount the TV at more than a 15 degree tilt.
- Standard dimensions for wall mount kits are shown in the table on the Quick setup guide.



Do not install your wall mount kit while your TV is turned on. This may result in personal injury from electric shock.

- Do not use screws that are longer than the standard dimension or do not comply with the VESA standard screw specifications. Screws that are too long may cause damage to the inside of the TV set.
- For wall mounts that do not comply with the VESA standard screw specifications, the length of the screws may differ depending on the wall mount specifications.
- Do not fasten the screws too firmly. This may damage the product or cause the product to fall, leading to personal injury. Samsung is not liable for these kinds of accidents.
- Always have two people mount the TV onto a wall. – For 82 inch or larger models, have four people mount the TV onto a wall.

### **Providing proper ventilation for your TV**

When you install your TV, maintain a distance of at least 10 cm between the TV and other objects (walls, cabinet sides, etc.) to ensure proper ventilation. Failing to maintain proper ventilation may result in a fire or a problem with the product caused by an increase in its internal temperature.

- When you install your TV with a stand or a wall mount, we strongly recommend you use parts provided by Samsung only. Using parts provided by another manufacturer may cause difficulties with the product or result in injury caused by the product falling.

### **Preventing the TV from falling**

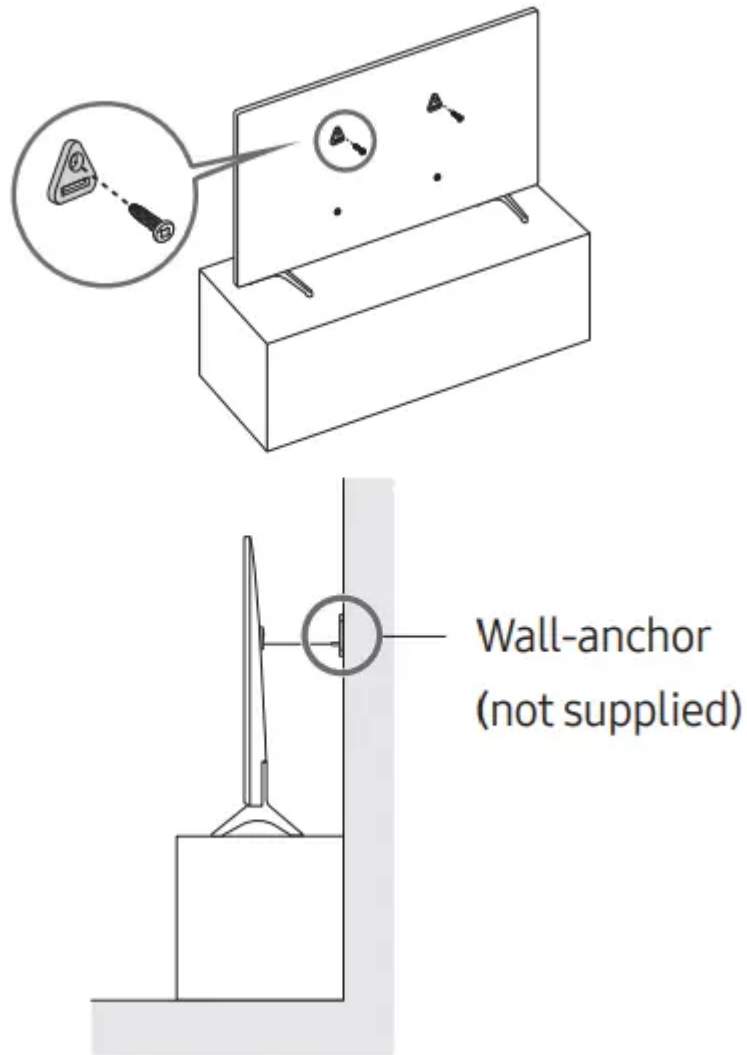

1. Using the appropriate screws, firmly fasten a set of brackets to the wall. Confirm that the screws are firmly attached to the wall.

– You may need additional material such as wall anchors depending on the type of wall.

2. Using the appropriately sized screws, firmly fasten a set of brackets to the TV.

– For the screw specifications, refer to the standard screw part in the table on the Quick Setup Guide.

3. Connect the brackets fixed to the TV and the brackets fixed to the wall with a durable, heavy-duty string, and then tie the string tightly.

– Install the TV near the wall so that it does not fall backwards.

– Connect the string so that the brackets fixed to the wall are at the same height as or lower than the brackets fixed to the TV.

## Operation

- This apparatus uses batteries. In your community, there might be environmental regulations that require you to dispose of these batteries properly. Please contact your local authorities for disposal or recycling information.
- Store the accessories (remote control, batteries, or etc.) in a location safely out of the reach of children.
- Do not drop or strike the product. If the product is damaged, disconnect the power cord and contact a Samsung service centre. • Do not dispose of remote control or batteries in a fire.
- Do not short-circuit, disassemble, or overheat the batteries.
- CAUTION: There is danger of an explosion if you replace the batteries used in the remote with the wrong type of battery. Replace only with the same or equivalent type.

• WARNING - TO PREVENT THE SPREAD OF FIRE, KEEP CANDLES AND OTHER ITEMS WITH OPEN FLAMES AWAY FROM THIS PRODUCT AT ALL TIMES.



## Caring for the TV

- To clean this apparatus, unplug the power cord from the wall outlet and wipe the product with a soft, dry cloth. Do not use any chemicals such as wax, benzene, alcohol, thinners, insecticide, aerial fresheners, lubricants, or detergents. These chemicals can damage the appearance of the TV or erase the printing on the product.
- The exterior and screen of the TV can get scratched during cleaning. Be sure to wipe the exterior and screen carefully using a soft cloth to prevent scratches.
- Do not spray water or any liquid directly onto the TV. Any liquid that goes into the product may cause a failure, fire, or electric shock.

## What's in the Box?

Make sure the following items are included with your TV. If any items are missing, contact your dealer.

- Standard Remote Control & Batteries
- Remote Control & Batteries (Depending on the model)
- Samsung Smart Remote & Batteries (Depending on the model)
- User Manual

- CI Card Adapter
- Warranty Card / Regulatory Guide (Not available in some locations)
- TV Power Cable
- The type of battery may vary depending on the model.
- The items' colours and shapes may vary depending on the models.
- Cables not included can be purchased separately.
- Check for any accessories hidden behind or in the packing materials when opening the box.



Warning: Screens can be damaged from direct pressure when handled incorrectly. We recommend lifting the TV at the edges, as shown. For more information about handling, refer to the Quick Setup Guide came with this product.

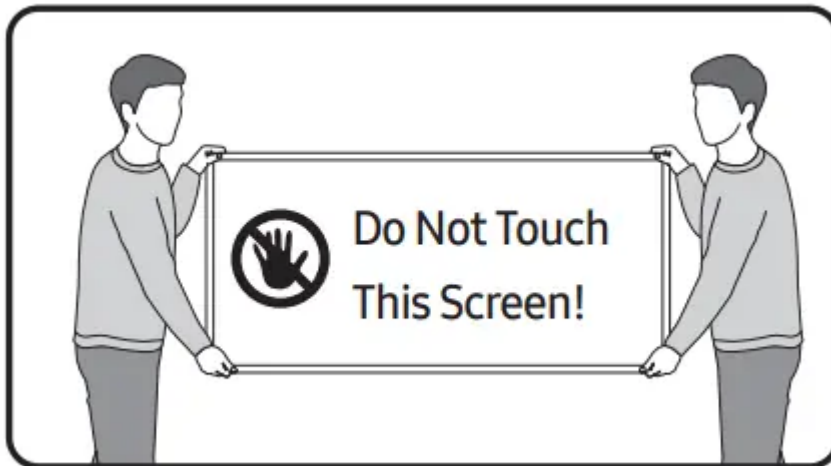

## Initial Setup

When you turn on your TV for the first time, it immediately starts the Initial Setup. Follow the instructions displayed on the screen and configure the TV's basic settings to suit your viewing environment.

### Using the TV Controller

You can turn on the TV with the TV Controller button at the bottom of the TV, and then use the Control menu. The Control menu appears when the TV Controller button is pressed while the TV is On.

- The screen may dim if the protective film on the SAMSUNG logo or the bottom of the TV is not detached. Please remove the protective film.

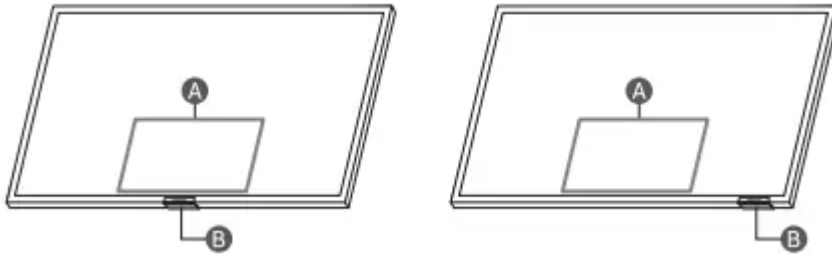

A. Control menu

B. TV Controller button / Remote control sensor

### **Setting the sound sensor**

This function is supported only in Q7\*A/Q8\*A/  
QN8\*A/QN9\*A Series.

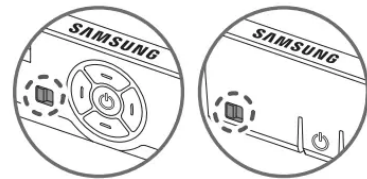

You can turn on or off the sound sensor by using its button at the bottom of the TV.

With the TV on, you can push the button to the left (or backward) to turn on the sound sensor or to the right (or forward) to turn off it.









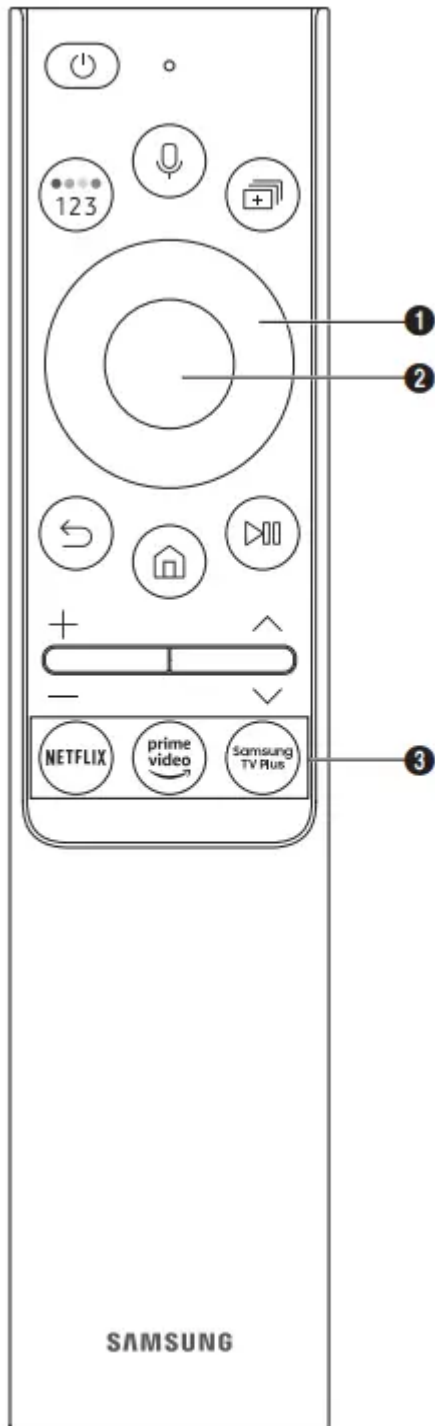





See the pop-up window on the TV to check whether the sound sensor is turned on or off.

- The position and shape of the sound sensor may differ depending on the model.
- During analysis using data from the sound sensor, the data is not saved.

# Remote control

## About the Buttons on the Samsung SolarCell Remote (Samsung Smart Remote)



Button	Description
 (Power)	Press to turn the TV on or off. For The Frame model, When watching TV, press to switch to <b>Art</b> mode. In <b>Art</b> mode, press to switch to watching TV. Press and hold to turn off the TV completely.
 (Voice Assistant)	Runs Voice Assistant. Press and hold the button, say a command, and then release the button to run Voice Assistant. <ul style="list-style-type: none"> <li>The supported Voice Assistant's languages and features may differ by geographical region.</li> </ul>
 (Colour / Number button)	Each time you press this button, the coloured buttons window and the virtual numeric pad are displayed alternately. <ul style="list-style-type: none"> <li>Use these coloured buttons to access additional options specific to the feature you are using.</li> <li>Press to bring up the virtual numeric pad on the screen. Use the numeric keypad to enter numeric values. Select numbers and then select <b>Done</b> to enter a numeric value. Use to change the channel, enter a PIN, enter a ZIP code, etc.</li> <li>When pressed for 1 second or more, the TTX menu appears.</li> </ul>
 (Multi View)	Press the button to directly enter the <b>Multi View</b> function. <ul style="list-style-type: none"> <li>When pressed for 1 second or more, the <b>Shortcuts</b> menu screen appears.</li> </ul>
 (Directional button (up, down, left, right))	Moves the focus and changes the values seen on the TV's menu.
 Select	Selects or runs a focused item. When pressed while you are watching a broadcast programme, detailed programme information appears.
 (Return)	Press to return to the previous menu. When pressed for 1 second or more, the running function is terminated. When pressed while you are watching a programme, the previous channel appears.
 (Smart Hub)	Returns to the Home Screen.
 (Play/pause)	When pressed, the playback controls appear. Using these controls, you can control the media content that is playing. To use Game Bar, press and hold the button in <b>Game Mode</b> . <ul style="list-style-type: none"> <li>Game Bar may not be supported depending on the model or geographical area.</li> </ul>
 (Volume)	Move the button up or down to adjust the volume. To mute the sound, press the button. When pressed for 1 second or more, the <b>Accessibility Shortcuts</b> menu appears.
 (Channel)	Move the button up or down to change the channel. To see the <b>Guide</b> screen, press the button. <ul style="list-style-type: none"> <li>When pressed for 1 second or more, the <b>Channel List</b> screen appears.</li> </ul>
 (Launch app button)	Press each button to run its function.
 (Pairing)	If the Samsung Smart Remote does not pair to the TV automatically, point it at the front of the TV, and then press and hold the  and  buttons simultaneously for 3 seconds or more.

– Use the Samsung Smart Remote less than 6 m from the TV. The usable distance may vary with the wireless environmental conditions.

– The images, buttons, and functions of the Samsung Smart Remote may differ with the model or geographical area.

– The Universal Remote function operates normally only when you use the Samsung Smart Remote that comes with the TV.

– It is recommended to use an original Samsung charger. Otherwise, it may cause performance degradation or failure of the product. In this case, the warranty service is not applicable.

– When the remote control does not work due to low battery, charge it by using the USB-C type port.

## About the Buttons on the Standard Remote Control

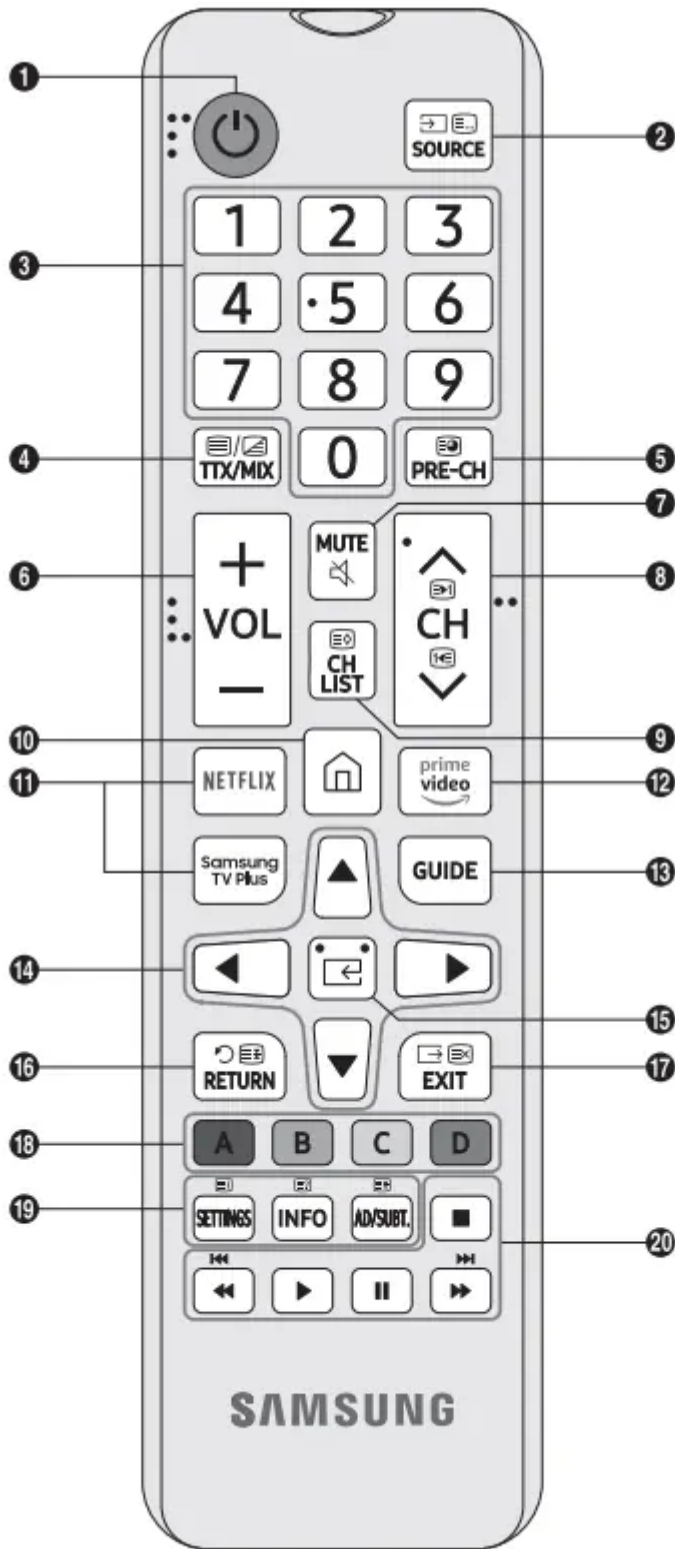

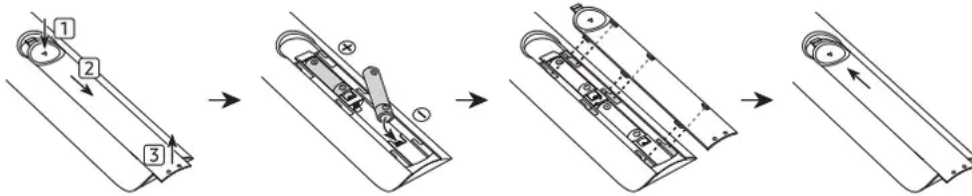

Number	Description
❶	⏻ (Power) Turns the TV on and off.
❷	Displays and selects available video sources.
❸	Gives direct access to channels.
❹	Alternately selects Teletext mode, Full TTX / Double TTX / Mix / Live TV.
❺	Returns to the previous channel.
❻	Adjusts the volume.
❼	Turns the sound on/off.
❽	Changes the current channel.
❾	Launches the Channel List.
❿	Launches Home Screen.
⓫, ⓬	Press each button to run its function.
⓭	Displays the Guide screen.
⓮	Moves the cursor, selects the on-screen menu items, and changes the values seen on the TV's menu.
⓯	⏏ (Select) Selects or runs a focused item.
⓰	Returns to the previous menu or channel.
⓱	Exits the menu.
⓲	Use these buttons according to the directions on the TV screen.
⓳	<b>SETTINGS</b> Displays the main on-screen menu. <b>INFO</b> Displays information about the current programme or content. <b>AD/SUBT.</b> Displays the Accessibility Shortcuts.
⓴	Use these buttons with specific features. Use these buttons according to the directions on the TV screen.

– The images, buttons, and functions of the remote control may differ depending on the model.

– This remote control has Braille points on the Power, Channel, Volume, and Select buttons and can be used by visually impaired persons.

– If you use the remote control that comes with your TV to control another TV, some functions may not operate normally.

## Troubleshooting and Maintenance

### Troubleshooting

For more information, see "Troubleshooting" or "FAQ" in the e-Manual.



**Settings > e-Manual > Troubleshooting or FAQ**

If none of the troubleshooting tips apply, please visit samsung website and click Support or contact the Samsung service centre.

- This TFT LED panel is made up of sub pixels which require sophisticated technology to produce. There may be, however, a few bright or dark pixels on the screen. These pixels will have no impact on the performance of the product.
- To keep your TV in optimum condition, upgrade to the latest software. Use the Update

Now or Auto update functions on the TV's menu (  **Settings > Support > Software Update > Update Now or Auto update**).

#### **The TV won't turn on.**



- Make sure that the AC power cable is securely plugged in to the TV and the wall outlet.
- Make sure that the wall outlet is working and the remote control sensor at the bottom of the TV is lit and glowing a solid red.
- Try pressing the TV Controller button at the bottom of the TV to make sure that the problem is not with the remote control. If the TV turns on, refer to "The remote control does not work".

#### **The remote control does not work.**

- Check if the remote control sensor at the bottom of the TV blinks when you press the remote's Power button.
  - AU Series or Standard Remote Control: If it does not blink, replace the remote control's batteries. Make sure that the batteries are installed with their poles (+/-) in the correct direction. Alkaline batteries are recommended for longer battery life.
  - Q Series (except for Standard Remote Control): When the remote's battery is discharged, turn over the remote control to charge with indoor light, or use the USB charging port.
- Try pointing the remote directly at the TV from 1.5-1.8 m away.
- If your TV came with a Samsung Smart Remote (Bluetooth Remote), make sure to pair the remote to the TV.

## Eco Sensor and screen brightness

Eco Sensor adjusts the brightness of the TV automatically. This feature measures the light in your room and optimises the brightness of the TV automatically to reduce power consumption. If you

want to turn this off, go to  >  **Settings > General > Power and Energy Saving > Brightness Optimisation.**

- The eco sensor is located at the bottom of the TV. Do not block the sensor with any object. This can decrease picture brightness.

## Specifications and Other Information

### Specifications

#### Display Resolution

Q5\*A Series: 1920 x 1080

AU7-AU9/Q6\*A-QN9\*A Series: 3840 x 2160

#### Sound (Output)

AU7/AU8/AU9/Q5\*A/Q6\*A/Q7\*A Series: 20 W

Q8\*A Series (50"): 40 W, Q8\*A Series (55"-85"): 60 W

QN8\*A Series: 60 W

QN9\*A Series (43"): 20 W, QN9\*A Series (50"): 40 W

QN9\*A Series (55"-85"): 60 W

#### Operating Temperature

10 °C to 40 °C (50 °F to 104 °F)

#### Operating Humidity

10 % to 80 %, non-condensing

#### Storage Temperature

-20 °C to 45 °C (-4 °F to 113 °F)

#### Storage Humidity

5 % to 95 %, non-condensing

#### Notes

- This device is a Class B digital apparatus.
- For information about the power supply, and more information about power consumption, refer to the information on the label attached to the product.

– On most models, the label is attached to the back of the TV. (On some models, the label is inside the cover terminal.)

- Typical power consumption is measured according to IEC 62087.
- To connect a LAN cable, use a CAT 7 (\*STP type) cable for the connection. (100/10 Mbps) \* Shielded Twisted Pair
- The images and specifications of the Quick Setup Guide may differ from the actual product.
- An administration fee may be charged in the following situations: (a) An engineer is called out at your request, but it is found that the product has no defect (i.e., where the user manual has not been read). (b) You bring the unit to the Samsung service centre, but it is found that the product has no defect (i.e., where the user manual has not been read).
- You will be informed of the administration fee amount before a technician visits.

### **Warning**

This content is compiled from multiple sources and is provided for reference purposes only. It may not be complete or fully applicable to all situations. If you are unable to resolve your issue, please contact the product manufacturer or an authorized service provider for official support.