

Installation

Connecting the Product

After completing installation, plug the sound bar power cable into an outlet in the following order.

1. Plug the power cable to the **AC IN** (AC input) terminal on the back of the product.
2. Plug the power cable connected to the product into an outlet. You will see the LED on the front of the product light up in red.

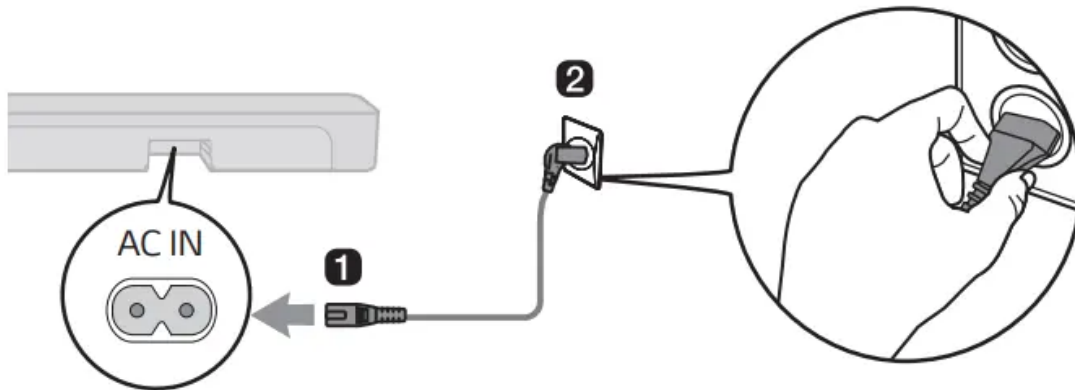

Exploring the Product

Front

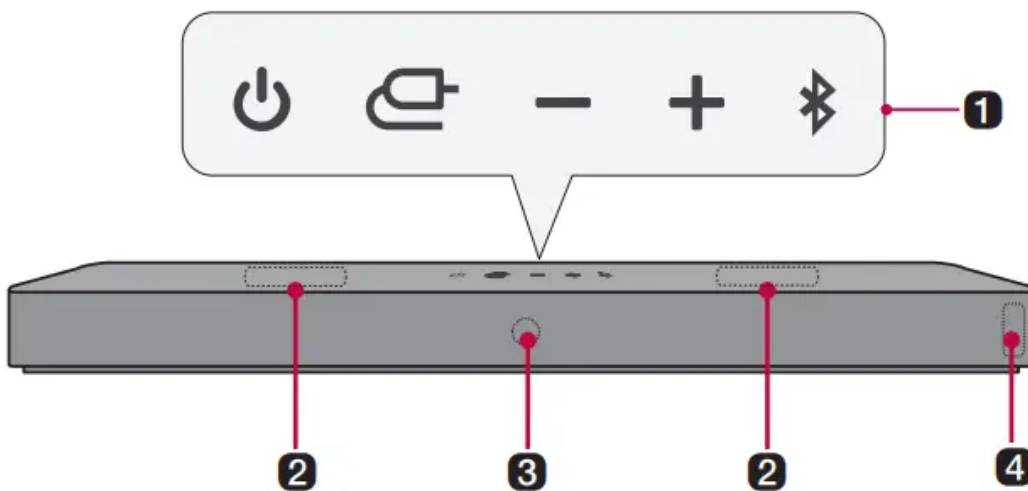

1. Power 

This turns the product on/off.

Function

Press the button repeatedly to select the desired function or input mode.

Status	Description
OPTICAL / HDMI ARC	Connects the product to a TV that supports an optical cable, ARC or LG Sound Sync.
Bluetooth	Connects the product via Bluetooth
LG TV	Connects the product to a TV that supports LG Sound Sync (Wireless)
HDMI IN	Connects the product to an HDMI input port
USB	Connects the product to a USB storage device

Volume

This adjusts the speaker volume

Bluetooth pair

It allows you to pair your Bluetooth device such as a smartphone to this product for three minutes. (See “Connecting via Bluetooth” on page 19.) It allows you to pair your LG TV to this product for three minutes. (See “Connecting with LG Sound Sync (Wireless)” on page 13.)

2. Passive Radiator

Make the bass sound improved.

3. Remote Control Receiver

This receives wireless signals from the remote control.

4. Status LED

- Options such as input mode and volume are light up in Red/Yellow green/ White/Blue/ Green LED.
- If there is no active input for 15 seconds, the status LED will automatically dim. When you press the button, the status LED will light up again

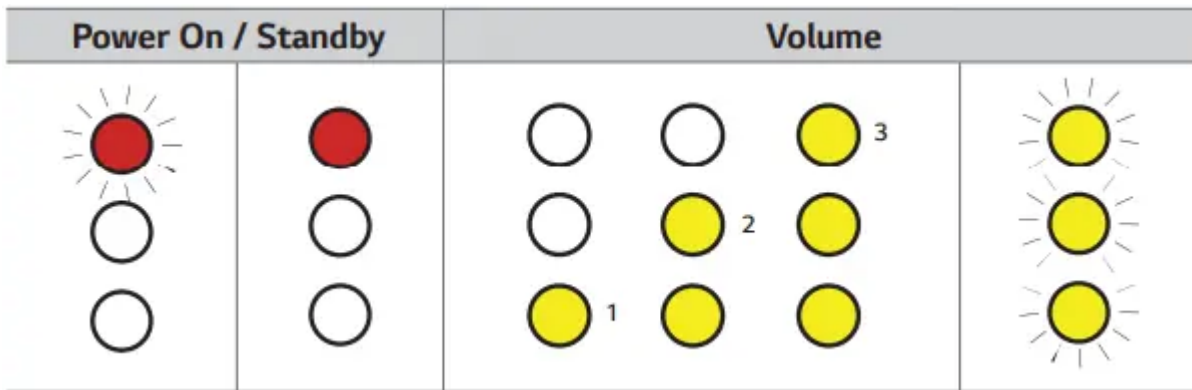

Power on	Standby	Volume control	Mute
Red blinking	Red	Yellow green <ul style="list-style-type: none"> • Volume up: Every time the volume level gets upper than a certain level, the LEDs light up one by one and gets brighter. • Volume down: Every time the volume level gets lower than a certain level, the LEDs turn off one by one and gets darker 	Yellow green (All the lights are blinking)

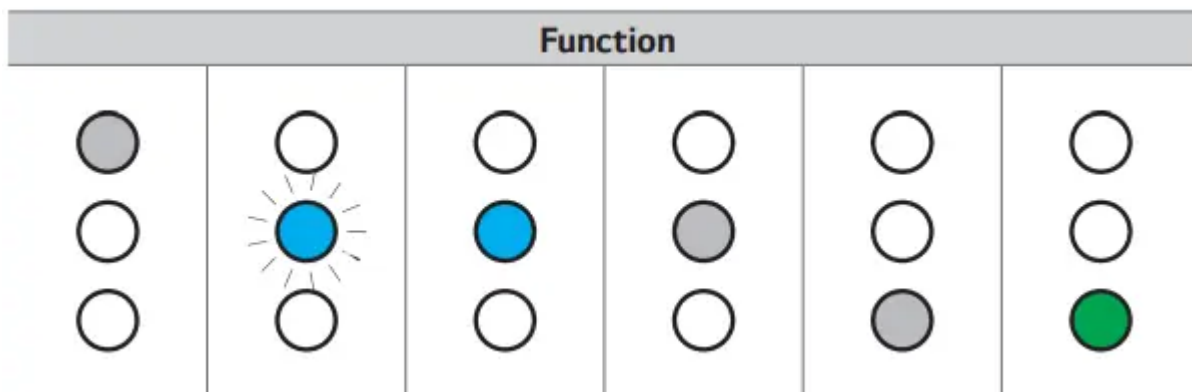

OPTICAL / HDMI ARC	Bluetooth ready	Bluetooth	LG TV	HDMI IN	USB
White	Blue blinking	Blue	White	White	Green

Note

- To reduce power consumption, the product will automatically turn off after 15 minutes of no input signal from an external device.

How to disconnect the wireless network connection or the wireless device



Set up the Auto power function to off by the app and turn off the product.

Back

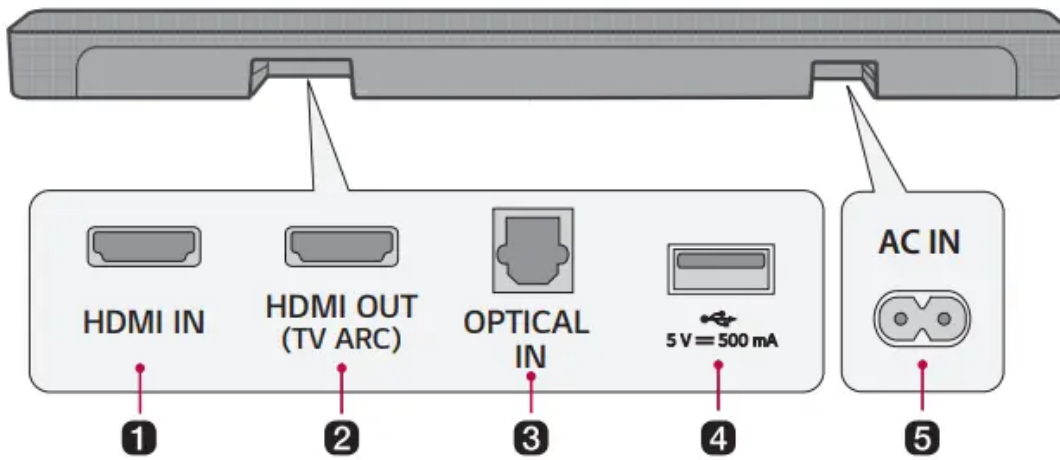

1. HDMI IN

Plug in an HDMI cable to connect an external device to the product.

2. HDMI OUT (TV ARC)

Plug in an HDMI cable to connect the TV to the product.

3. OPTICAL IN

Plug in an optical cable to connect the TV to the product.

4. USB port

Plug in a USB storage device to play music with the product.

5. AC IN

Plug in a power cord.

Exploring Remote Control

You can use the remote to control all functions of the product, from turning the power on/off to enabling cinematic sound.

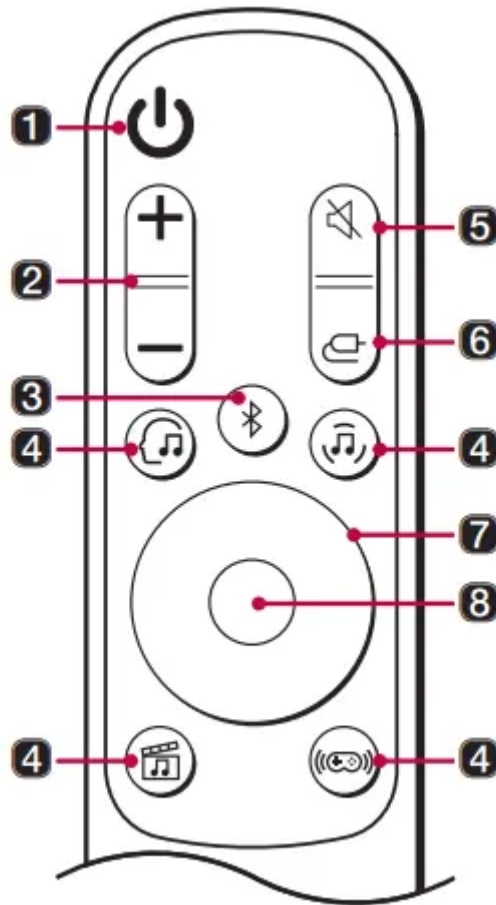

Use AA 1.5V batteries. Replace the two batteries by inserting them into the remote control in accordance with the directions indicated.

1. Open the battery cover on the back of the remote control.
2. Insert the batteries with the + and – ends corresponding to the markings.
3. Close the battery cover.

Risk of fire or explosion if the battery is replaced by an incorrect type.

1. Power 

Turns the product on/off

2. Volume 

Adjusts the sound volume

3. Bluetooth pair

It allows you to pair your Bluetooth device such as a smartphone to this product for three minutes. (**Bluetooth pair** See “Connecting via Bluetooth” on page 19.) It allows you to pair your LG TV to this product for three minutes. [**Bluetooth pair** See “Connecting with LG Sound Sync (Wireless)” on page 13.]



4. AI Sound Pro

Artificial intelligence selects the optimal sound settings to suit your content.

Standard

You can enjoy optimised sound.

Cinema

Play content with 3D sound similar to a movie theater.

Game

Optimised sound for game.

5. Mute

This turns off the sound from the product.

6. Function

Press the button repeatedly to select the desired input mode or function.

7. Up/Down/Left/ Right

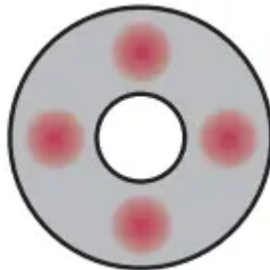

Up/Down: You can press the button to adjust the built-in woofer level.

Left/Right: If you play a previous song, press Left button. If you play a next song, press Right button.

8. Play/Pause

If you play or pause a song, press this button.

Replacement of Battery

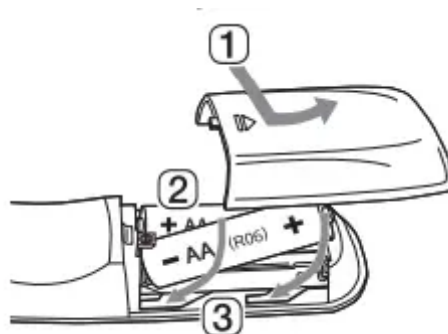

Connecting to the TV

Enjoy a rich, high-quality sound by connecting the product to a TV or a beam projector. It has been designed to enhance the realism of your favourite programming, such as dramas and sports broadcasts.

Connecting with an Optical Cable

Transmit your TV's audio to the product by connecting it to the TV with an optical cable. You can add a variety of 3D effects to the original audio to fill the room with a deep, rich sound.

Watching TV after connecting with an optical cable

1. If the digital cable terminal has a cover, first remove the covers from both ends



2. Using an optical cable, connect the OPTICAL IN terminal on the back of the product to the Optical Digital Output (OPTICAL OUT) terminal on the TV as shown in the picture

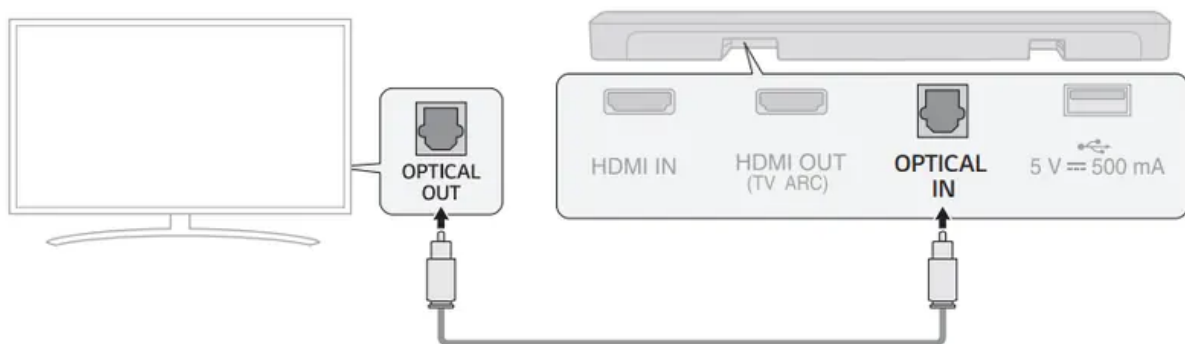

3. Press the Function  button repeatedly until the first from above LED lights up in white among the three LEDs.

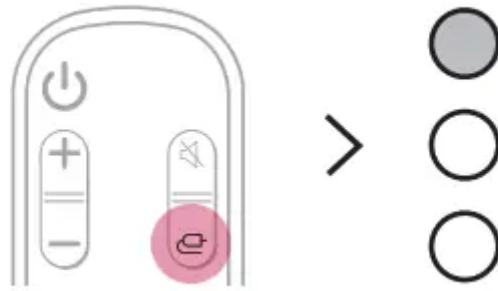

4. Press the Settings button on the TV remote control to enter the [Speaker] menu and set the output speaker to [Optical] or [External Speaker]. Settings and menu items may vary depending on the TV manufacturer

Note

- If the optical input signal and the ARC signal attempt to connect at the same time, the ARC signal will take priority.

When you use an LG TV

You can adjust the volume with the LG TV remote control if the TV is connected to the product with an optical cable. You can only do so on a TV that supports the LG TV Sound Sync function. Check your TV's user manual to see if your TV is supported.

Functions controllable with an LG TV remote control

Volume, mute on/off

Note



- When using the product with an LG TV remote control, the volume and mute status set on the TV will automatically be applied to the product.
- You can still use the product's remote control even after connecting it to an LG TV.
- To use LG Sound Sync, you may have to change the sound setting of your TV. It may vary depending on the TV

Connecting with LG Sound Sync (Wireless)

You can adjust the volume with the LG TV remote control if the TV is connected to the product with LG Sound Sync (Wireless). Check out the TV user manual to see if your TV is supported.



Watching TV after connecting it wirelessly

1. Press the **Function**  button repeatedly until the second LED lights up in white among the three LEDs. After a moment, it will change to blue and blink. Or Press the **Bluetooth pair**  button. After a moment, second LED lights up in blue and blinking.
2. Press the Settings button on the TV remote control and enter the [Speaker] menu to set the output speaker to [LG Sound Sync (Wireless)].
3. When the product is connected to the TV via **Bluetooth**, the second LED lights up in white among the three LEDs.

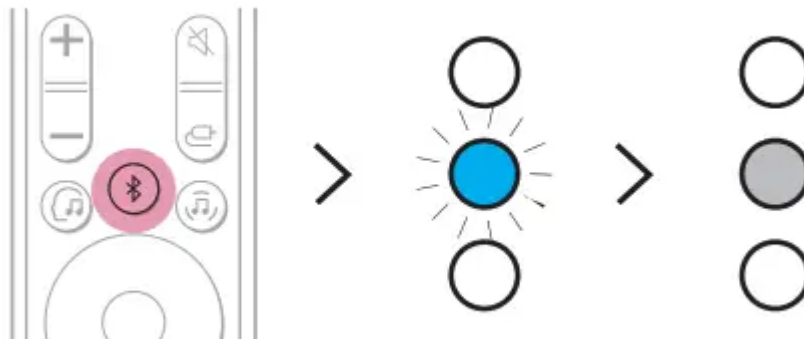
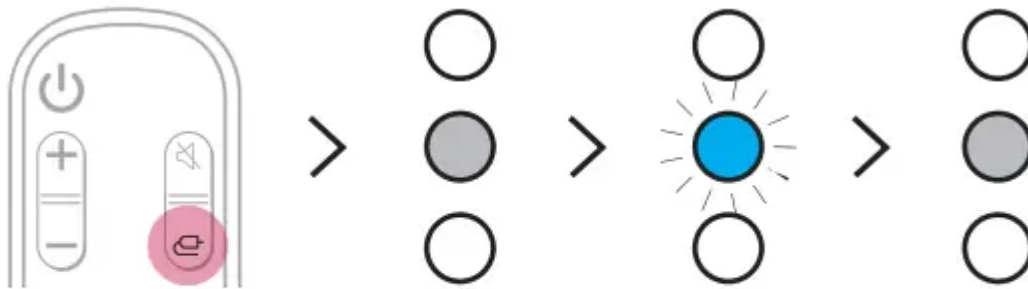

Note

- When reconnecting after the first connection with LG Sound Sync, immediately lights up as a white LED.
- When using the product with an LG TV remote control, the volume and mute status set on the TV will automatically be applied to the product.
- You can still use the product's remote control even after connecting it to an LG TV.
- If you turn off the power of the product with the Power  button, the LG Sound Sync (Wireless) will be disconnected.

- Depending on the TV, the product may be connected to the LG TV even if it is connected with the **Bluetooth** function.

Connecting with an HDMI Cable

You can transmit TV audio to the product by connecting the TV to the product with an HDMI cable. Add a variety of 3D effects to the original audio to fill the room with a deep, rich sound.

Watching TV after connecting with an HDMI cable

1. Using the HDMI cable, connect the HDMI OUT (TV ARC) terminal on the back of the product to the HDMI IN (ARC) terminal on the TV as shown in the picture.

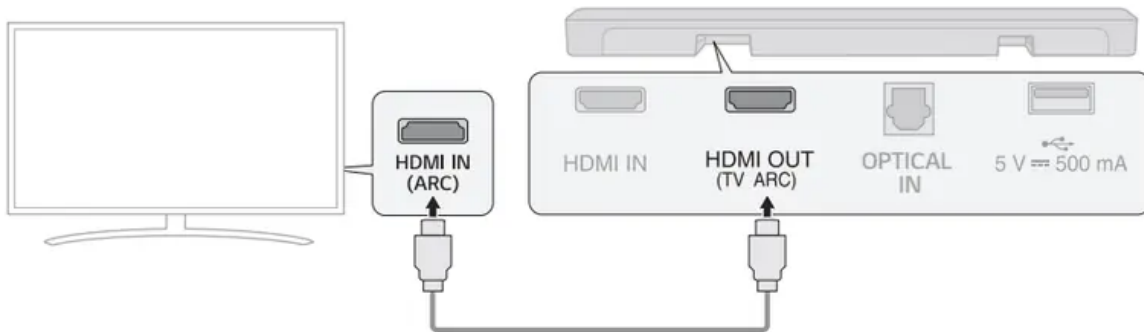

2. Press the Function button repeatedly until the first from above LED lights up in white among the three LEDs.

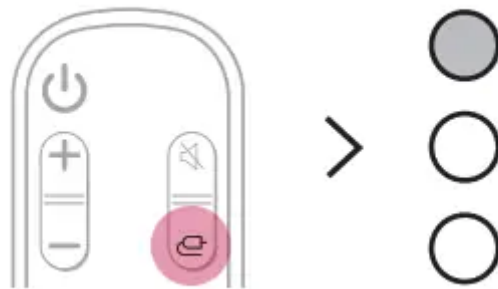

3. Press the Settings button on the TV remote control to enter the [Speaker] menu and set the output speaker to [HDMI ARC]. Settings and menu items may vary depending on the TV manufacturer

Note

- Make sure that your TV supports the ARC function before you press the Setting button on the TV remote control and turn on ARC. For more information on how to set the function, refer to the TV user manual as it may differ depending on the TV.
- Use a certified cable with the HDMI logo.

SIMPLINK

- SIMPLINK refers to the HDMI-CEC function that allows you to use a single TV remote control to easily operate an audio device or player connected to an LG TV via HDMI.
 - Functions controllable with a SIMPLINK-compatible LG TV remote control: Power on/off, volume control, mute on/off, etc.
- For more information on how to set up SIMPLINK, consult your LG TV's user manual.



Connecting to an External Device

Experience movies and games in more realism by connecting the product to a device such as a game console or a Blu-ray player.

Connecting with an HDMI Cable

You can connect your TV or external device to the product with an HDMI cable for a deep, magnificent sound.

Connecting an external device via HDMI

1. Connect an external device such as a DVD or Blu-ray player. Following the picture below, connect the HDMI OUT terminal of the device to the HDMI IN terminal on the back of the product.
2. Using the HDMI cable, connect the HDMI OUT (TV ARC) terminal on the back of the product to the HDMI IN (ARC) terminal on the TV.

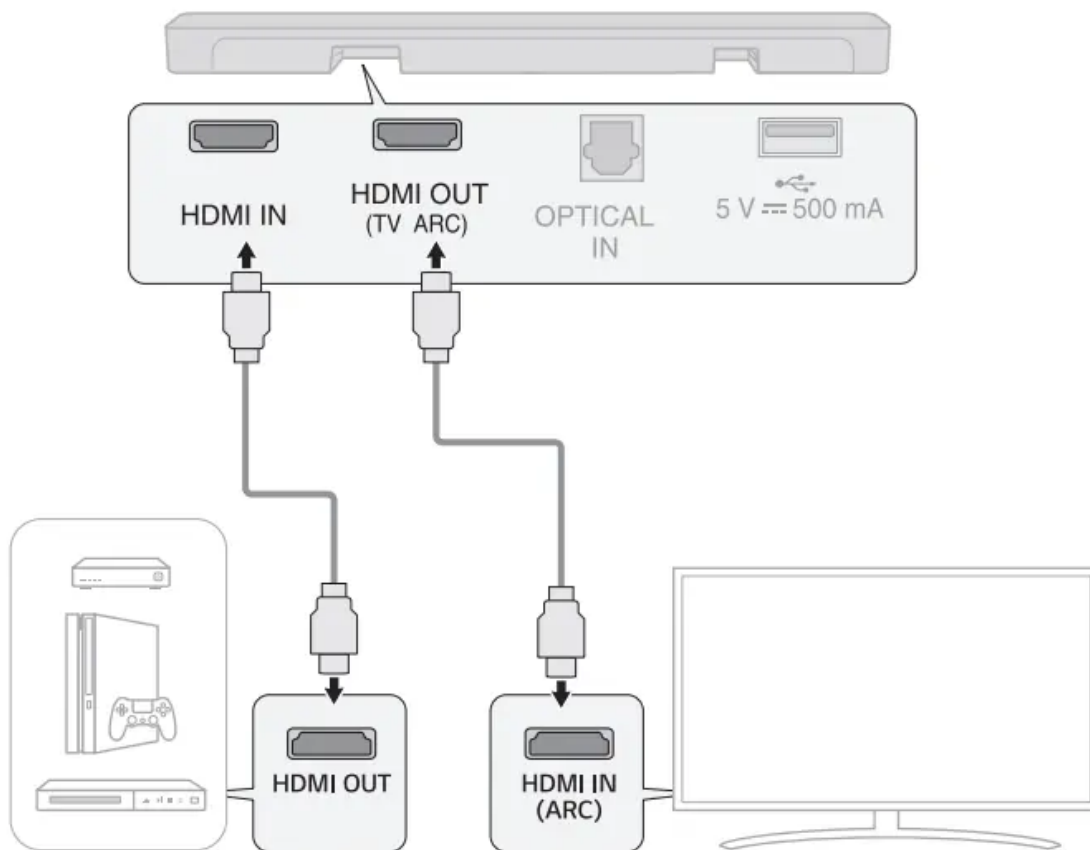

3. Press the Function  button repeatedly until the third LED lights up in white among the three LED

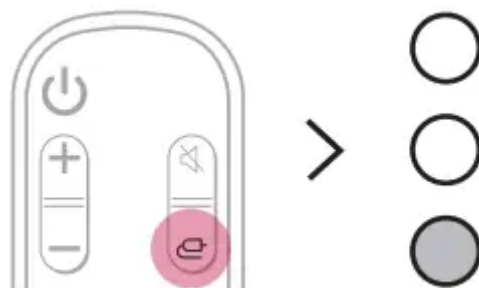

4. When the external device is properly connected to the product, you can listen to the sound of the device

Note

- Please check the audio output settings in the Settings menu of your external device (ex. Bluray player or TV). The audio output should be set to [No encoding], [Bitstream], [Auto], or [Pass through]. For more information on how to set the output, please refer to your external device's user manual.
- Use a certified cable with the HDMI logo.





Connecting with an Optical Cable

You can connect a TV or external device to the product with an optical cable for a deep, magnificent sound.

Connecting an external device via optical cable

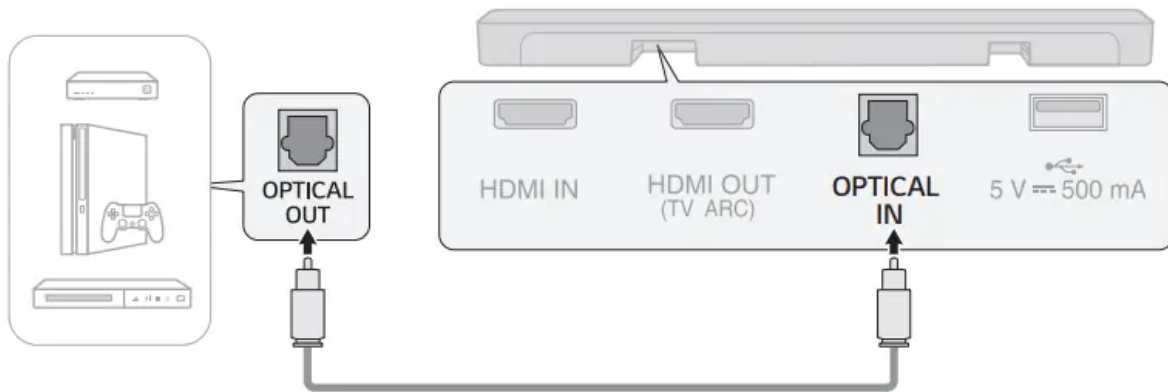
1. Use the optical cable to connect the OPTICAL IN terminal on the back of the product to the OPTICAL OUT terminal of your external device (ex. TV, Blu-ray player) as shown in the picture.



2. Press the Function  button repeatedly until the first from above LED lights up in white among the three LEDs.

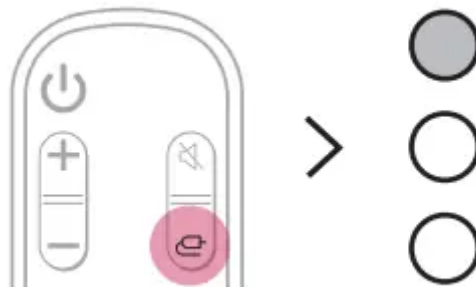

Using the Product as an Audio System

Connecting via Bluetooth

You can play music files stored on a Bluetooth device, or run music apps to enjoy the music with this product

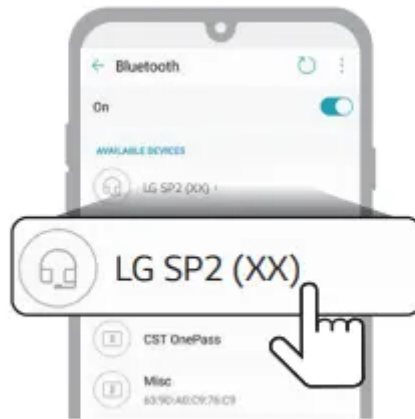

6. When the product is connected to the smartphone via Bluetooth, the blue LED stops blinking

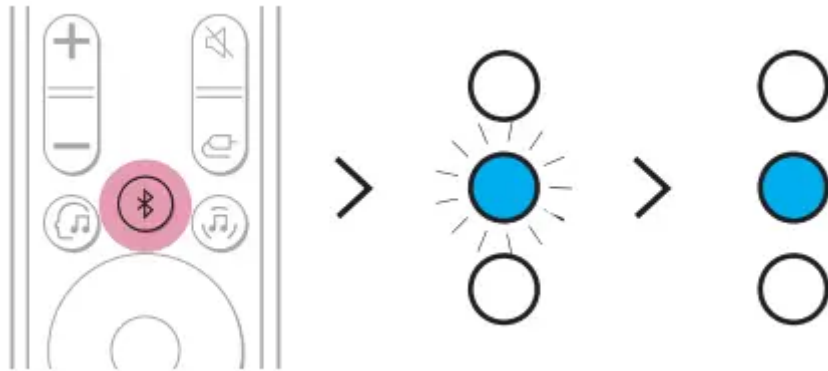

7. If you cannot find the product “LG SP2 (XX)”, tap the Refresh button at the top right of the screen on the Android smartphone or turn the Bluetooth off and turn it on again on iPhone.



<Android Phone>

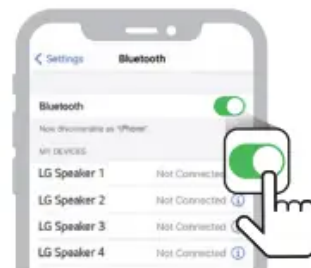

<iPhone>

8. Run a Music app and listen to music on the smartphone.





Note

- The closer the Bluetooth device is to the product, the better your connection.
- If you pressed the Bluetooth pair  button of the product and selected the Bluetooth option, but could not connect to the Bluetooth device, the blue LED blinking for 3 minutes. Check the status of the Bluetooth device.
- When using Bluetooth, you should adjust the volume level to an appropriate level.
- XX is the last 2 digits of the MAC address of the product. For example, if the MAC address is 9C:02:98:4A:F7:08, it will be displayed as “LG SP2 (08)”

Connecting with a Smartphone via LG Sound Bar app

Please use the LG Sound Bar app to run various functions of the product conveniently.

Please check the following first.

- The LG Sound Bar app is available in the versions listed below.
 - Android™ OS: Version 5.0 or higher
 - iOS OS: Version 10 or higher

Installing the app

Install the LG Sound Bar app on your smartphone. To install the LG Sound Bar app, you can scan the QR code with a QR code scan app or download on Google Play or the App Store.

Downloading with a QR code

1. Scan the QR code below with a QR code scan app.
2. You will be directed to a page where you can download the LG Sound Bar app. Tap the app to install it

Downloading from the Google Play or App Store

Go to the Google play or the App Store on your smartphone and search for the LG Sound Bar app to install it.

Connecting to a USB Storage Device

Enjoy high-quality sound by connecting a USB storage device containing music files to the product.

Connecting the product to a USB storage device

1. Plug the USB storage device into the USB port on the back of the product.

- The product cannot play any devices connected via a USB storage device hub or a USB storage device cable.
- The product cannot be connected to any USB storage device, USB type MP3 player, or card reader that requires a separate device drive to be installed.

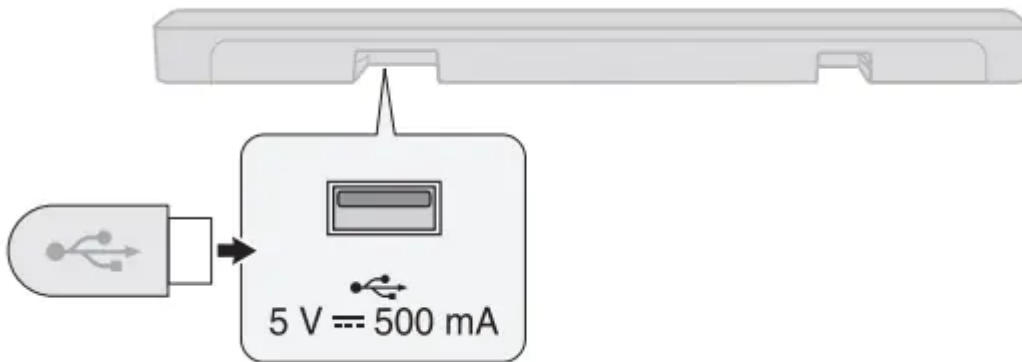

2. Press the Function  button repeatedly until the third LED lights up in green among the three LEDs.

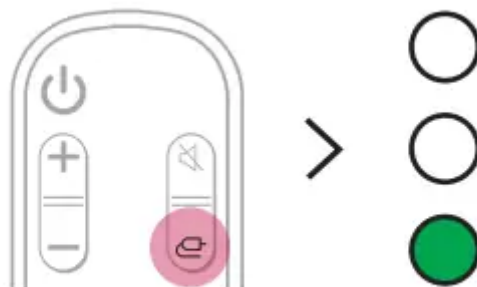

3. Press the Play/Pause  button on the remote control to enjoy the music.

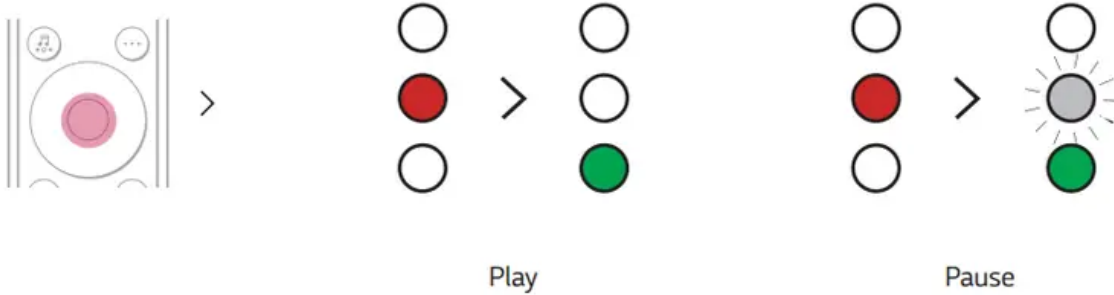

Note

- It is recommended that you purchase a separate USB gender changer to make it easier to plug in and out USB storage devices.
- Purchase a USB gender changer with a USB 2.0 extension cable.
- USB devices with a large storage volume may take several minutes to browse through files.
- LG Electronics is not responsible for any data loss. Please always back up the data on your USB storage device to minimise damage caused by data loss.
- Only FAT16/FAT32/NTFS formats are supported. exFAT format is not supported.

USB storage devices supported

- **MP3 player** - Flash MP3 player
- **USB flash device** - USB 2.0 or higher

This product may not recognise some USB storage devices

Mounting the Product to a Wall

You can mount this product onto a wall.

When mounting the product to the wall, follow the instructions below.

Please check the following first.

- It may be difficult to connect external devices and cables after wall-mounting. First, connect an external device with the proper connection cable to the product before mounting it to the wall.
- Please note the following when you mount the product to the wall. Product damage or injury may occur during the process.
 - Do not put objects on top of the wall-mounted product.
 - Secure the product firmly to the wall using the fixing screws so that it does not fall off.

- Ensure it is out of the reach of children. Pulling or shaking the mounted product may cause it to fall

Components for mounting the product

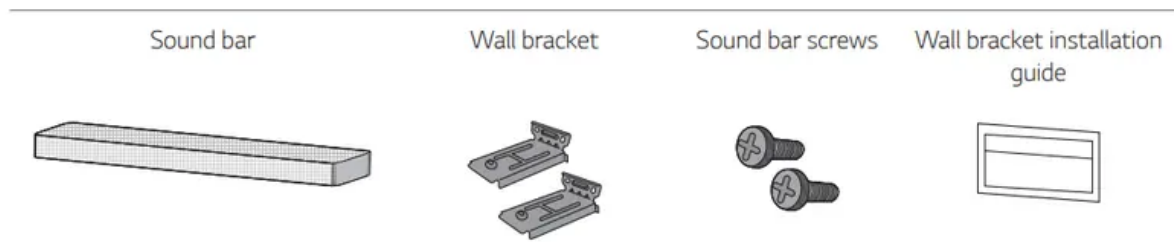

Sold separately

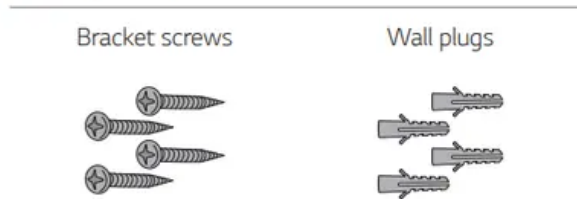

Note

- Screws and Wall Plugs are not supplied for mounting the product. We recommend the Hilti (HUD-1 6 x 30) for the mounting

Mounting the Product to a Wall

1. Find the wall bracket installation guide in the product package.
2. Align the “TV Bottom Line” on the wall bracket installation guide with the bottom of the TV, and attach it to the wall. Align the centre of the wall-mounted TV with the part marked “TV Center” in the installation guide.

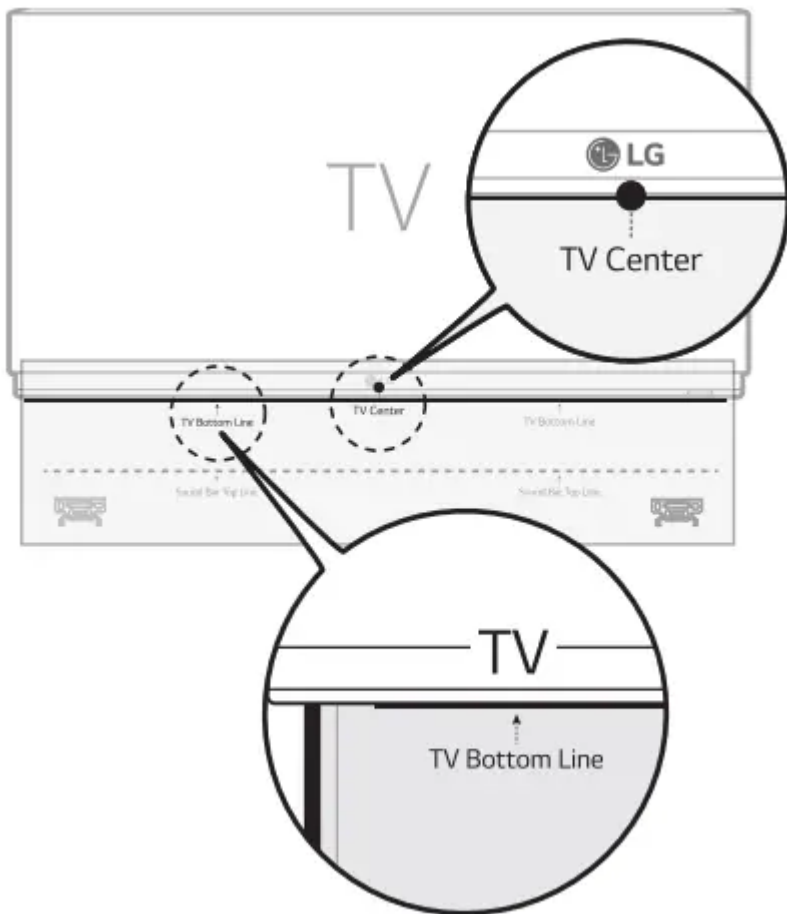

3. With a pen, mark screw holes on the installation guide where the wall brackets will be attached.

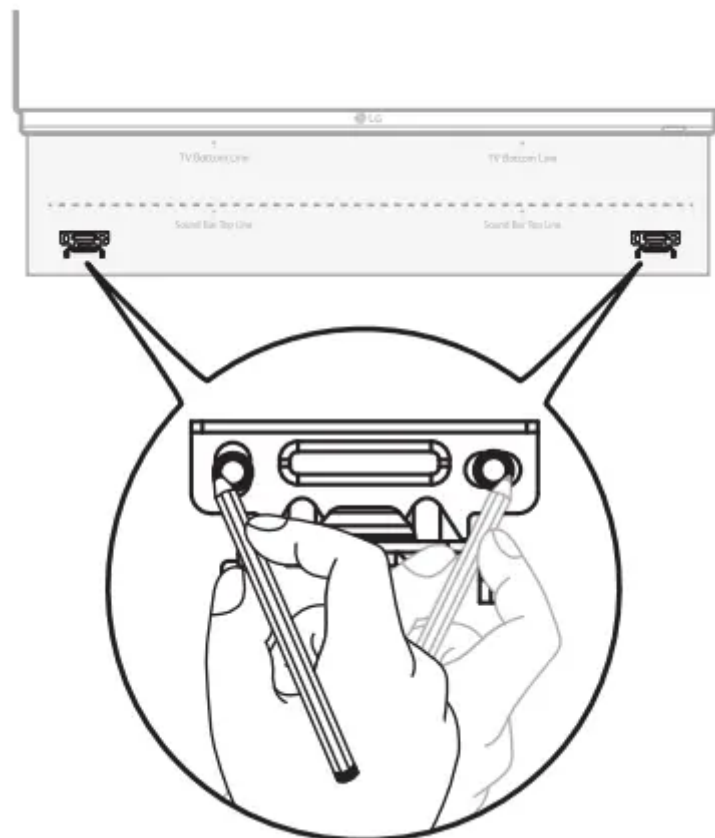

4. Drill screw holes in the marked positions on the installation guide.
5. Remove the wall bracket installation guide from the wall.
6. Fix the brackets firmly to the wall using the wall plugs and screws.

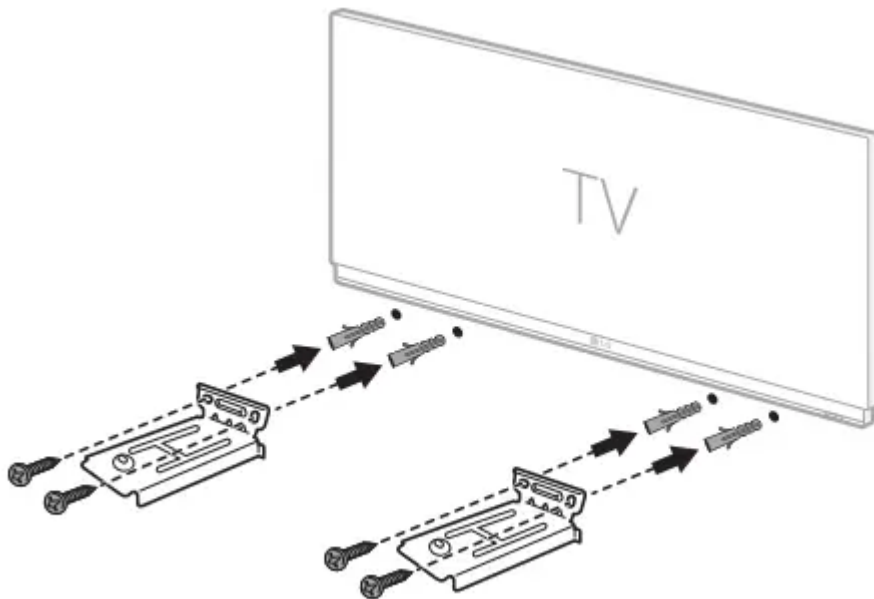

7. Place the product on the brackets. Position the product on the brackets so the screw holes on the bottom of the product align with the screw holes on the wall bracket.

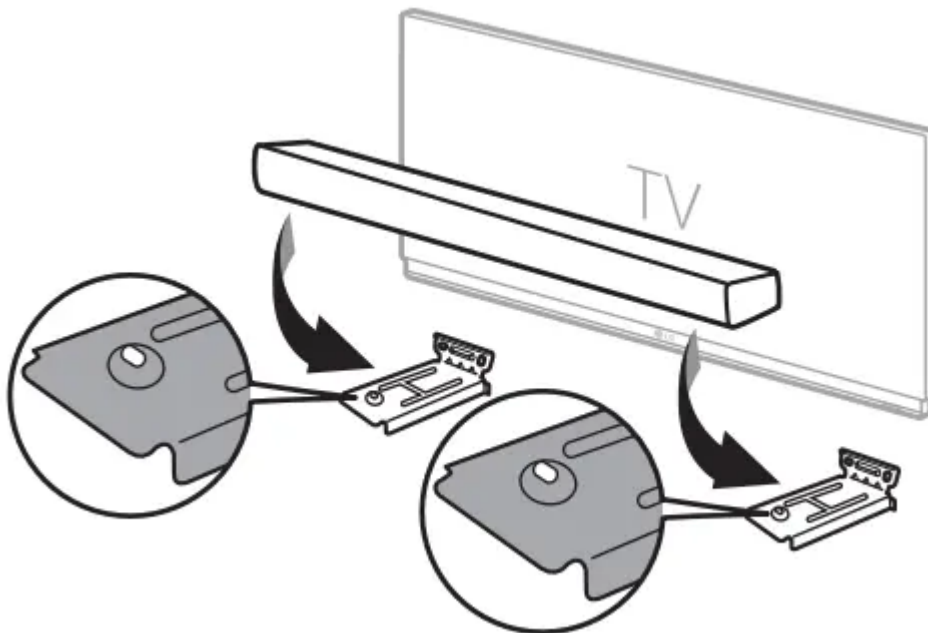

8. Firmly attach the product to the wall brackets using the screws provided

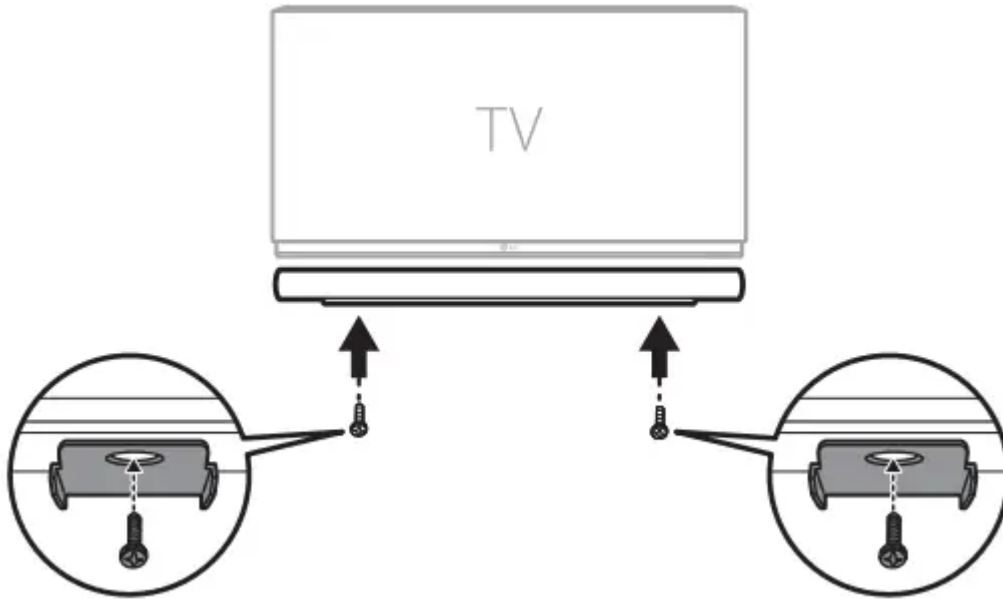





Before Reporting Product Malfunction

Troubleshooting

If you experience the following issues while using the product, please perform several checks, as they may not be malfunctions.

General Errors

Issue	Solution
<p>The product does not work properly</p>	<ul style="list-style-type: none"> • Unplug the power cables and any external devices such as your TV, subwoofer, or amplifier from the product, then plug them in again. • Please beware that previous product settings may be lost.
<p>The power does not turn on</p>	<ul style="list-style-type: none"> • Is the power cord plugged into the outlet properly? <ul style="list-style-type: none"> - Connect the power plug to the outlet correctly
<p>There is no sound</p>	<ul style="list-style-type: none"> • Is the volume set to minimum? <ul style="list-style-type: none"> - Press the Volume   button on the remote control to turn up the volume. <ul style="list-style-type: none"> - If you are using an external device such as a set-top box, portable device, or Bluetooth device, adjust the volume of the external device. • Is the mute function activated? <ul style="list-style-type: none"> - If all the three LEDs are blinking in Yellow green, the mute function is on. Press the Mute  button to unmute. • Is the correct product function selected according to the external device connected? <ul style="list-style-type: none"> - Press the Function  button to check if you selected the correct function.
<p>The remote control does not work properly</p>	<ul style="list-style-type: none"> • When using the remote control, point it at the front of the product. • Use the remote control within a 7-m radius of the product. • Replace the batteries with new ones as needed.
<p>LG Sound Sync does not work</p>	<ul style="list-style-type: none"> • Check whether your TV supports LG Sound Sync. • Check if the TV is properly connected to the product via an optical cable <ul style="list-style-type: none"> . - Press the Settings button on the TV remote control to check if the function is turned on in [LG Sound Sync].

<p>The product volume is low</p>	<ul style="list-style-type: none"> • Check the following and change the settings accordingly. <ul style="list-style-type: none"> - When the product is connected to a TV, press the Settings button on the TV remote control, select the [Speaker] menu, and change the [Digital Sound Output] setting from [PCM] to [AUTO] or [BITSTREAM]. - If the product is connected to a playback device such as a DVD player or Blu-ray disc player, go to the connected device's Settings menu. Change the [Digital Sound Output] setting from [PCM] to [PRIMARY PASS-THROUGH] or [BITSTREAM]. Set the [DRC] of the connected device to [OFF].
<p>The product fails to recognise a USB storage device</p>	<ul style="list-style-type: none"> • The product may not support the file format of the USB storage device. Format the USB storage device and reconnect it. When formatting, refer to the USB storage device formats supported by the product and select an appropriate file format. (See “Connecting to a USB Storage Device” on page 24.)
<p>A Bluetooth device cannot be paired</p>	<ul style="list-style-type: none"> • Press the Settings button on the Bluetooth device and check whether the Bluetooth function is enabled. If Bluetooth is enabled, turn it off and on, then try again. • Remove any obstacles between the product and the Bluetooth device. • Bluetooth pairing (connection) may not work properly depending on the Bluetooth device type or the surrounding environment.

Warning

This content is compiled from multiple sources and is provided for reference purposes only. It may not be complete or fully applicable to all situations. If you are unable to resolve your issue, please contact the product manufacturer or an authorized service provider for official support.

