

Location of Controls

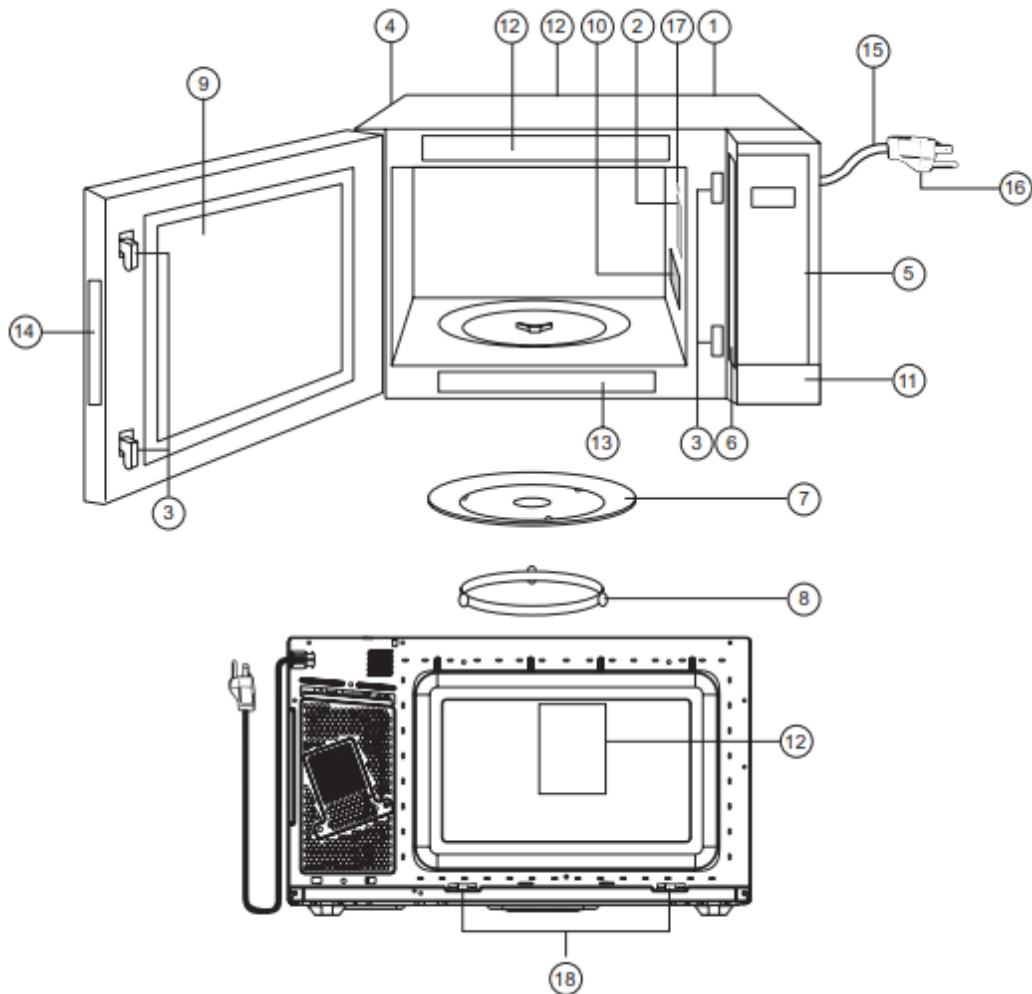

1. External Air Vent
2. Internal Air Vent
3. Door Safety Lock System
4. Exhaust Air Vent
5. Control Panel
6. Identification Plate
7. Glass Tray
8. Roller Ring
9. Heat/Vapor Barrier Film
(do not remove)

10. Waveguide Cover

(do not remove)

11. Door Release Button

12. Warning Label

13. Menu Label

(do not remove)

14. DHHS Label

15. Power Supply Cord

16. Power Supply Plug

17. Oven Light

Oven light will turn on during cooking and also when door is opened.

18. Stopper (irremovable)

The stopper ensures sufficient space at the back of the oven to provide adequate ventilation.

Control Panel

The control panels of NN-SN67KS/NN-SN66KB/NN-SN65KB/NN-SN65KW have the same key layout and function.

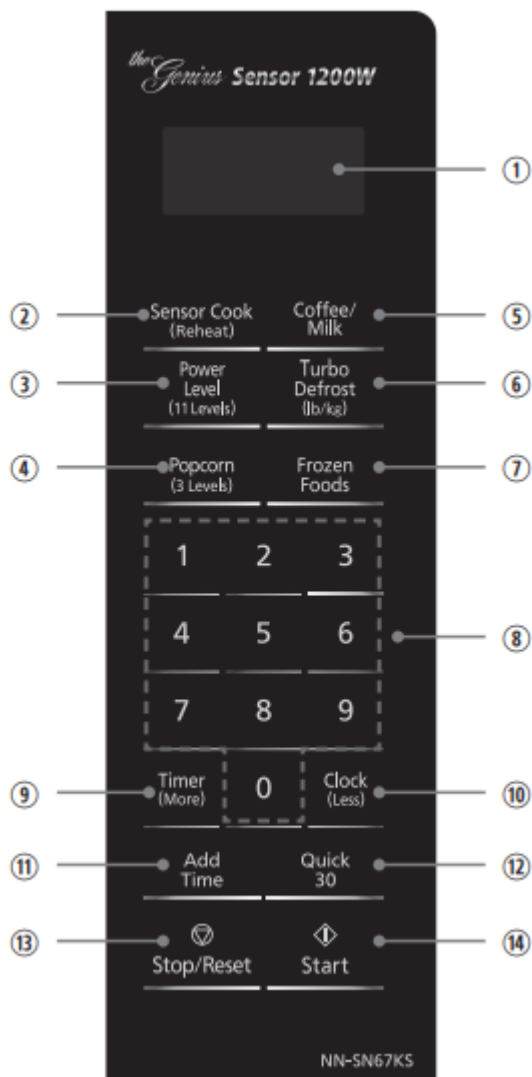

1. Display Window
2. Sensor Cook (Reheat) Pad (See page 18)
3. Power Level Pad (See page 12)
4. Popcorn Pad (See page 16)
5. Coffee/Milk Pad (See page 17)
6. Turbo Defrost Pad (See page 14)
7. Frozen Foods Pad (See page 17)
8. Number Pads
9. Timer (More) Pad (See page 15)
10. Clock (Less) Pad (See page 11)
11. Add Time Pad (See page 13)
12. Quick 30 Pad (See page 13)
13. Stop/Reset Pad

Before cooking: One press clears all your instructions.

During cooking: One press temporarily stops the cooking process. Another tap cancels all your instructions, and time of day or colon appears in the display window.

14. Start Pad

After cooking program setting, one press allows oven to begin functioning. If door is opened or Stop/Reset Pad is pressed once during oven operation, Start Pad must be pressed again to restart oven.

Beep Sound:

When a pad is pressed correctly, a beep will be heard. If a pad is pressed and no beep is heard, the unit did not or cannot accept the instruction.

When operating, the oven will beep twice between programmed stages. At the end of any complete program, the oven will beep 5 times.

NOTE:

If no operation after cooking program setting, 6 minutes later, the oven will automatically cancel the cooking program. The display will return to clock or colon display.

NOTE:

The illustration is for reference only.

Operation

Using the Microwave for the First Time

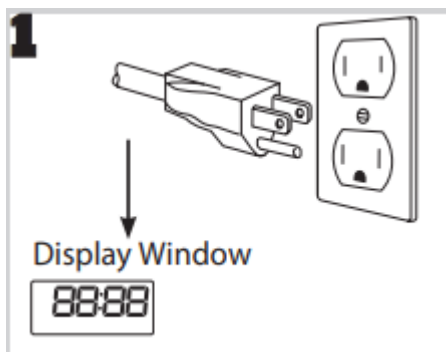

Plug into a properly grounded electrical outlet.

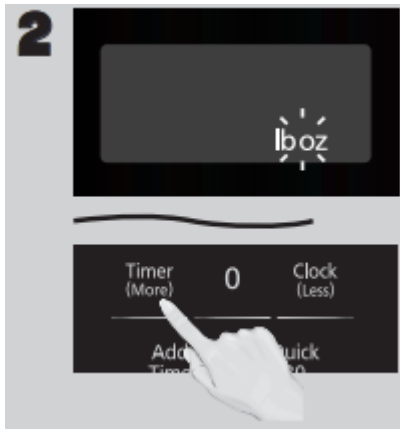

Press Start once, then Press Timer (More) to cycle between the weight system, Imperial (oz/lb) or Metric (g/kg).



Press Start once, then Press Timer (More) to cycle between the Beep on or Beep off.

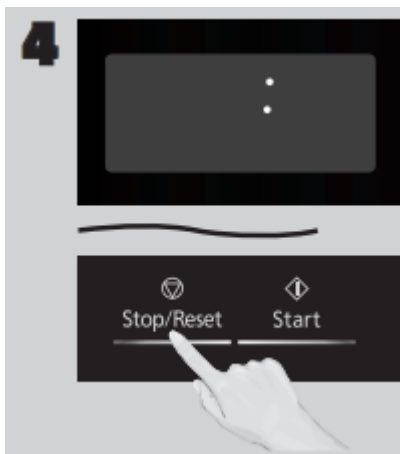

Press Stop/Reset to confirm; a colon (:) will appear in the display window.

NOTES: These choices can be selected only when you plug-in the oven.

Setting the Clock



With the oven NOT cooking, press Clock (Less) once; the colon will blink. Enter time of day using the Number pads.



Press Clock (Less) to finish setting and the colon (:) will stop blinking.

NOTES:

- To reset the clock, repeat steps.
- The clock will retain the time of day as long as the oven is plugged in and electricity is supplied.
- The clock is a 12-hour display.
- Oven will not operate while colon (:) is flashing.

Setting the Child Safety Lock



When the time of day appears in the display, press Start three times; “” will appear in the display



Press Stop/Reset three times; the display will return to the time of the day and Child Safety Lock will be cancelled.

NOTES:

1. This feature prevents the electronic operation of the oven until cancelled. It does not lock the door.
2. To set or cancel Child Safety Lock, Start or Stop/Reset pad must be pressed 3 times within 10 seconds.
3. You can set Child Safety Lock feature when the display shows a colon or time of day.

Cooking

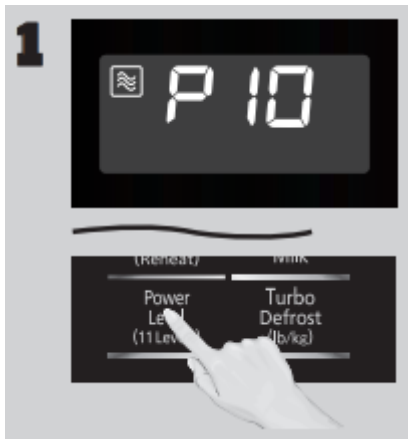

If cooking at high power (10), skip to step 2. Press Power Level until the desired power level appears in the display. P10 is the highest and P1 is the lowest. P0 is the keep warm feature.

Press	Power Level
once	P10 (HIGH)
twice	P9
3 times	P8
4 times	P7 (MED-HIGH)
5 times	P6 (MEDIUM)
6 times	P5
7 times	P4
8 times	P3 (MED-LOW)/ DEFROST
9 times	P2
10 times	P1 (LOW)
11 times	P0 (KEEP WARM)



Set cooking time using the Number pads. P10 (HIGH) and P0 (KEEP WARM) have max. cooking time of 30 minutes. For other power levels, the max. time is 99 minutes, 99 seconds.



Press Start; the cooking will start and the time will count down in the display. At the end of cooking, five beeps will sound.

NOTES:

1. For reheating, use P10 (HIGH) for liquids, P7 (MED-HIGH) for most foods, and P6 (MEDIUM) for dense foods.
2. For defrosting, use P3 (MED-LOW).
3. After pressing Start, the selected power level can be recalled. Hold Power Level for 2 seconds, then the display window will indicate the power level and keep for 2 seconds.

DO NOT OVERCOOK: This oven requires less time to cook than older units. Overcooking will cause food to dry out and may cause a fire. A microwave oven's cooking power tells you the amount of microwave power available for cooking.

Multistage Cooking: For more than one stage of cooking, repeat steps 1 and 2 for each stage of cooking before pressing Start. The maximum number of stages for cooking is three. When operating, two beeps will sound between each stage. Five beeps will sound at the end of the entire sequence. Automatic function (such as Frozen Foods, Sensor Cook (Reheat), Popcorn, Coffee/Milk and Turbo Defrost) can not be used with 3 stage cooking.

Keep Warm

(Will keep food warm for up to 30 minutes after cooking)





Press Power Level 11 times to select the P0 (KEEP WARM).



Set warming time using Number pads (up to 30 minutes). Set 20 minutes cooking for an example.



Press Start; the cooking will start and the time will count down in the display. At the end of cooking, five beeps will sound.

NOTES:

1. P0 (KEEP WARM) can be set as the final stage after cook time has been manually entered. It cannot be used with Automatic function (such as Frozen Foods, Sensor Cook (Reheat), Popcorn, Coffee/Milk and Turbo Defrost).

2. After pressing Start, the selected power level can be recalled. Hold Power Level for 2 seconds, then the display window will indicate the power level and keep for 2 seconds.

Quick 30

(Set or add cooking time in 30 seconds increments)



Press Quick 30 until the desired cooking time (up to 5 minutes) appears in the display. Power Level is pre-set at P10.



Press Start; the cooking will start and the time will count down in the display. At the end of cooking, five beeps will sound.

NOTES:

1. This function is only available for Microwave, Keep Warm and Timer. If desired, you can use other power levels. Select desired power level before pressing Quick 30.
2. After setting the time by Quick 30 pad, you cannot use the Number Pads.
3. Quick 30 pad can also be used to add more time during manual cooking.

Add Time

(This feature allows you to add cooking time at the end of previous cooking.)



After cooking, press Add Time pad.



Add cooking time by pressing the Number pads. Maximum cooking time: Microwave: P10 up to 30 minutes; other powers up to 99 minutes and 99 seconds.



Press Start. Time will be added. The time in the display window will count down.

NOTES:

1. This function is only available for Microwave, Keep Warm and Timer function.
2. The Add Time function will be cancelled if you do not perform any operation for 1 minute after cooking.
3. The Add Time function can be used after the 3-stage cooking.
4. The power level is the same as the last stage.

Turbo Defrost

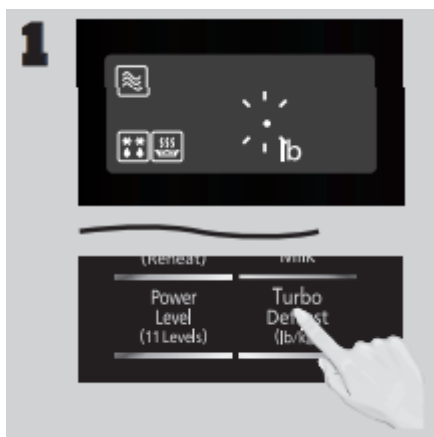

This feature allows you to defrost foods such as meat, poultry and seafood, simply by entering the weight. Press Turbo Defrost.



Enter weight of the food using the Number pads.



Press Start. Defrosting will start. Larger weight foods will cause a signal midway through defrosting. If two beeps sound, turn over and/or rearrange foods.

NOTE: The maximum weight for Turbo Defrost is 6 lbs. (3 kg).

Setting the Kitchen Timer



This feature allows you to program the oven as a kitchen timer. Press Timer (More) once.





Set desired amount of time using Number pads (up to 99 minutes, 99 seconds).



Press Start. The timer will count down without cooking and beep five times when done.

Caution: If oven lamp is lit while using the timer feature with door closed, the oven is NOT set properly; STOP OVEN IMMEDIATELY and re-read instructions.

Setting a Standing Time



Some recipes call for a standing time after cooking. Press Power Level until the desired power level appears in the display.



Set cooking time using the Number pads (see page 12 for maximum times).



Press Timer (More) once.



Set desired standing time using Number pads (up to 99 minutes, 99 seconds).



Press Start. The timer will start and then beep twice at the end of cooking time (the beginning of standing time). Five beeps will sound when standing time is done.

Setting a Delayed Start



This feature can be used to delay the start of your cooking. To do this, first press Timer (More).

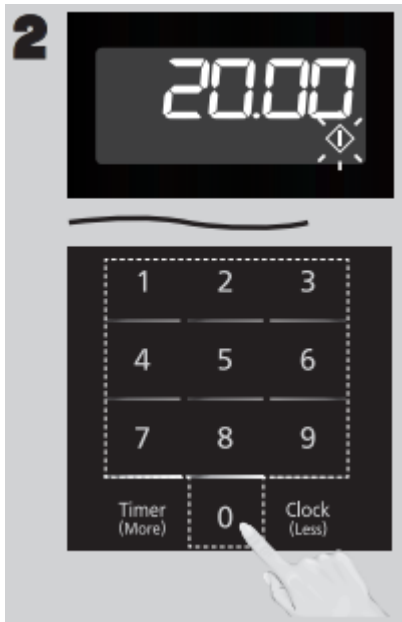

Enter the desired delay time (up to 99 minutes, 99 seconds) using the Number pads.



Press Power Level until the desired power level appears in the display.



Set Cooking Time using the Number pads (see page 12 for maximum times).



Press Start; the delay time will count down, then cooking will begin. At the end of cooking, five beeps will sound.

NOTES:



1. When each stage finishes, the oven will beep twice. At the end of the program, the oven will beep five times.
2. If the oven door is opened during Standing Time, Kitchen Timer or Delayed Start, the time on the display will continue to count down.
3. Standing Time and Delayed Start cannot be programmed before any automatic function (such as Frozen Foods, Sensor Cook (Reheat), Popcorn, Coffee/ Milk and Turbo Defrost). This is to prevent the starting temperature of food from rising.
4. When using Standing Time or Delayed Start, it's up to 2 power stages.

Sensor Reheat

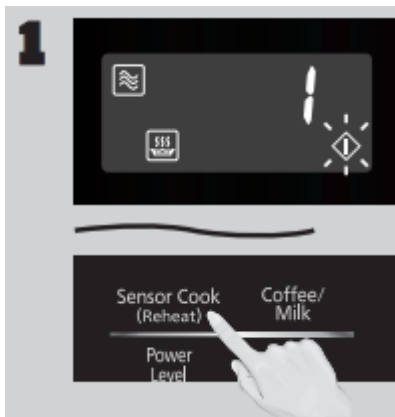

Press Sensor Cook (Reheat) once.

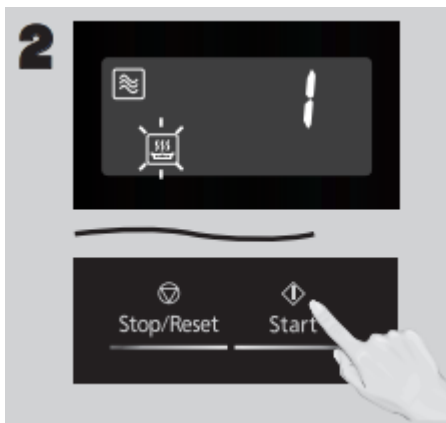

Press Start. Reheating is complete when five beeps sound.

NOTES:

1. If the user desires, More/Less adjustment can be done. Press Timer (More) to add 20% more time than suggested. Press Clock (Less) to subtract 20% cooking time. Press Timer (More) or Clock (Less) before pressing Start.

2. After having used the Sensor Reheat feature a few times, you may decide you would prefer your food cooked to a different doneness – that is why you would utilize the Timer (More) or Clock (Less) pads.

3. When steam is detected by the Genius Sensor and two beeps sound, the remaining cooking time will appear in the display.

Casseroles: Add 45 to 60 ml (3 to 4 tablespoons) of liquid, cover with lid or vented plastic wrap. Stir when time appears in the display window.

Canned foods: Empty contents into casserole dish or serving bowl, cover dish with lid or vented plastic wrap. After reheating, let stand for a few minutes.

Plate of food: Arrange food on plate; top with butter, gravy, etc. Cover with lid or vented plastic wrap. After reheating, let stand for a few minutes.

DO NOT USE SENSOR REHEAT:

1. To reheat bread and pastry products. Use manual power and time for these foods.
2. For raw or uncooked foods.
3. If oven cavity is warm.
4. For beverages.
5. For frozen foods.

Sensor Cook

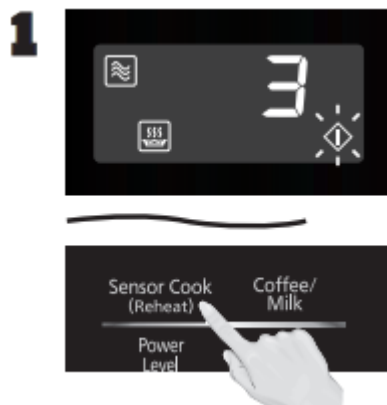

Press Sensor Cook (Reheat) until the number corresponding to the desired food appears in the display (see chart on the next page).

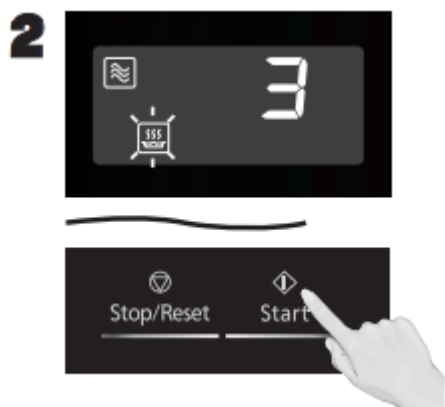

Press Start. Cooking is complete when five beeps sound.

NOTES:

1. If the user desires, More/ Less adjustment can be done. Press Timer (More) to add 20% more time than suggested. Press Clock (Less) to subtract 20% cooking time. Press Timer (More) or Clock (Less) before pressing Start.
2. After having used the Sensor Cook feature a few times, you may decide you would prefer your food cooked to a different doneness – that is why you would utilize the Timer (More) or Clock (Less) pad.
3. When steam is detected by the Genius Sensor and two beeps sound, the remaining cooking time will appear in the display.
4. Automatic features are provided for your convenience. If results are not suitable to your individual preference, or if serving size is other than what is listed on page 19, please refer to manual cooking on page 12.

For the best results with the GENIUS SENSOR, follow these recommendations:

BEFORE Reheating/Cooking:

1. The room temperature surrounding the oven should be below 95 °F (35 °C).
2. Food weight should exceed 4 oz. (110 g).
3. Be sure the glass tray, the outside of the cooking containers and the inside of the microwave oven are dry before placing food in the oven. Residual beads of moisture turning into steam can mislead the sensor.
4. Cover food with lid, or with vented plastic wrap. Never use tightly sealed plastic containers—they can prevent steam from escaping and cause food to overcook.

DURING Reheating/Cooking:

DO NOT open the oven door until two beeps sound and cooking time appears in the display. Doing so will cause inaccurate cooking since the steam from food is no longer contained within the oven cavity.

Once the cooking time begins to count down, the oven door may be opened to stir, turn or rearrange foods.

AFTER Reheating/Cooking:

All foods should have a standing time.

Care and Cleaning of Your Microwave Oven

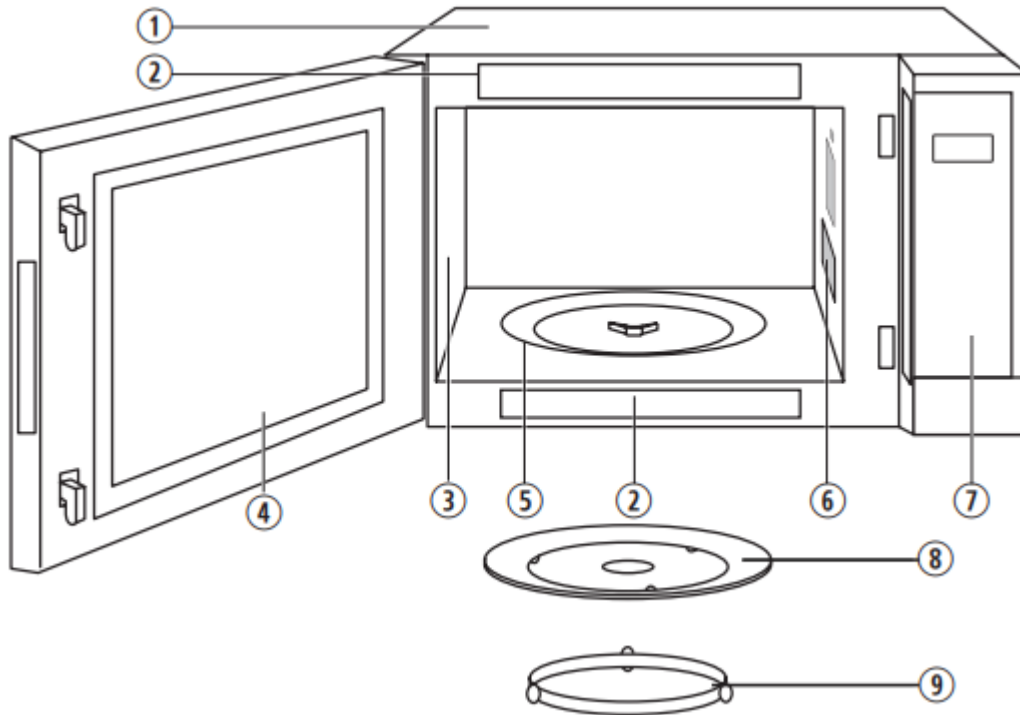

Please see below and the following page for particular cleaning instructions for each section of the oven.

BEFORE CLEANING: Unplug oven at wall outlet. If outlet is inaccessible, leave oven door open while cleaning.

AFTER CLEANING: Be sure to place the Roller Ring and the Glass Tray in the proper position and press Stop/Reset Pad to clear the Display.

1. Outside oven surfaces: Clean with a damp cloth. To prevent damage to the operating parts inside the oven, water should not be allowed to seep into ventilation openings.
2. Label: Do not remove. Wipe with a damp cloth.
3. Inside the Oven: Wipe with a damp cloth after using. Mild detergent may be used if needed. Do not use harsh detergents or abrasives.
4. Oven Door: Wipe with a soft dry cloth when steam accumulates inside or around the outside of the oven door. During cooking, especially under high humidity conditions, steam is given off from

the food. (Some steam will condense on cooler surfaces, such as the oven door. This is normal.) Inside surface is covered with a heat and vapor barrier film. Do not remove.

5. Oven Cavity Floor: Clean the bottom surface of the oven with mild detergent, water or window cleaner, and dry.

6. Wave Guide Cover: Do not remove Wave Guide Cover. It is important to keep cover clean in the same manner as the inside of the oven.

7. Control Panel: The Control Panel is covered with a removable protective film to prevent scratches during shipping. Small bubbles may appear under this film, so if this is the case, remove by applying masking or clear tape to an exposed corner and pull gently. If the Control Panel becomes wet, clean it with a soft dry cloth. Do not use harsh detergents or abrasives.

8. Glass Tray: Remove and wash in warm soapy water or in a dishwasher.

9. Roller Ring: Roller Ring may be washed in mild soapy water or dishwasher. These areas should be kept clean to avoid excessive noise.

Before Requesting Service

See below before calling for service, as most problems can easily be remedied by following these simple solutions:

Problem	Solution
The oven causes TV interference.	Some radio, TV, Wi-Fi, cordless telephone, baby monitor, blue tooth or other wireless equipment interference might occur when you cook with the microwave oven. This interference is similar to the interference caused by small appliances such as mixers, vacuums, blow dryers, etc. It does not indicate a problem with your oven.
Steam accumulates on oven door and warm air comes from the oven vents.	During cooking, steam and warm air are given off from the food. Most of the steam and warm air are removed from the oven by the air which circulates in the oven cavity. However, some steam will condense on cooler surfaces such as the oven door. This is normal. After use, the oven should be wiped dry (see page 24).
Oven will not turn on.	<p>The oven is not plugged in securely or needs to be reset; remove plug from outlet, wait ten seconds and re-insert.</p> <p>Main circuit breaker or main fuse is tripped; reset main circuit breaker or replace main fuse.</p> <p>There is a problem with the outlet; plug another appliance into the outlet to check if it is working.</p>
Oven will not start cooking.	<p>The door is not completely closed; close the oven door securely.</p> <p>Start was not pressed after programming; press Start.</p> <p>Another program is already entered into the oven; press Stop/Reset to cancel the previous program and enter new program.</p> <p>The program is not correct; program again according to the Owner's Manual. Stop/Reset has been pressed accidentally; program oven again.</p>
The Glass Tray wobbles.	The Glass Tray is not positioned properly on the Roller Ring or there is food under the Roller Ring; take out Glass Tray and Roller Ring. Wipe with a damp cloth and reset Roller Ring and Glass Tray properly.
When the oven is operating, there is	

noise coming from the Glass Tray.	The Roller Ring and oven bottom are dirty; clean these parts according to Care and Cleaning of Your Microwave Oven (see page 24).
The word “  ” appears in the display.	The CHILD SAFETY LOCK was activated by pressing Start three times; Deactivate CHILD SAFETY LOCK by pressing Stop/Reset three times.
The oven stops cooking and “H00”, “H97” or “H98” appears in the display.	The oven’s power supply has failed; please contact an authorized Service Center (see next page).

Warning

This content is compiled from multiple sources and is provided for reference purposes only. It may not be complete or fully applicable to all situations. If you are unable to resolve your issue, please contact the product manufacturer or an authorized service provider for official support.

