

## Operation Component Locations

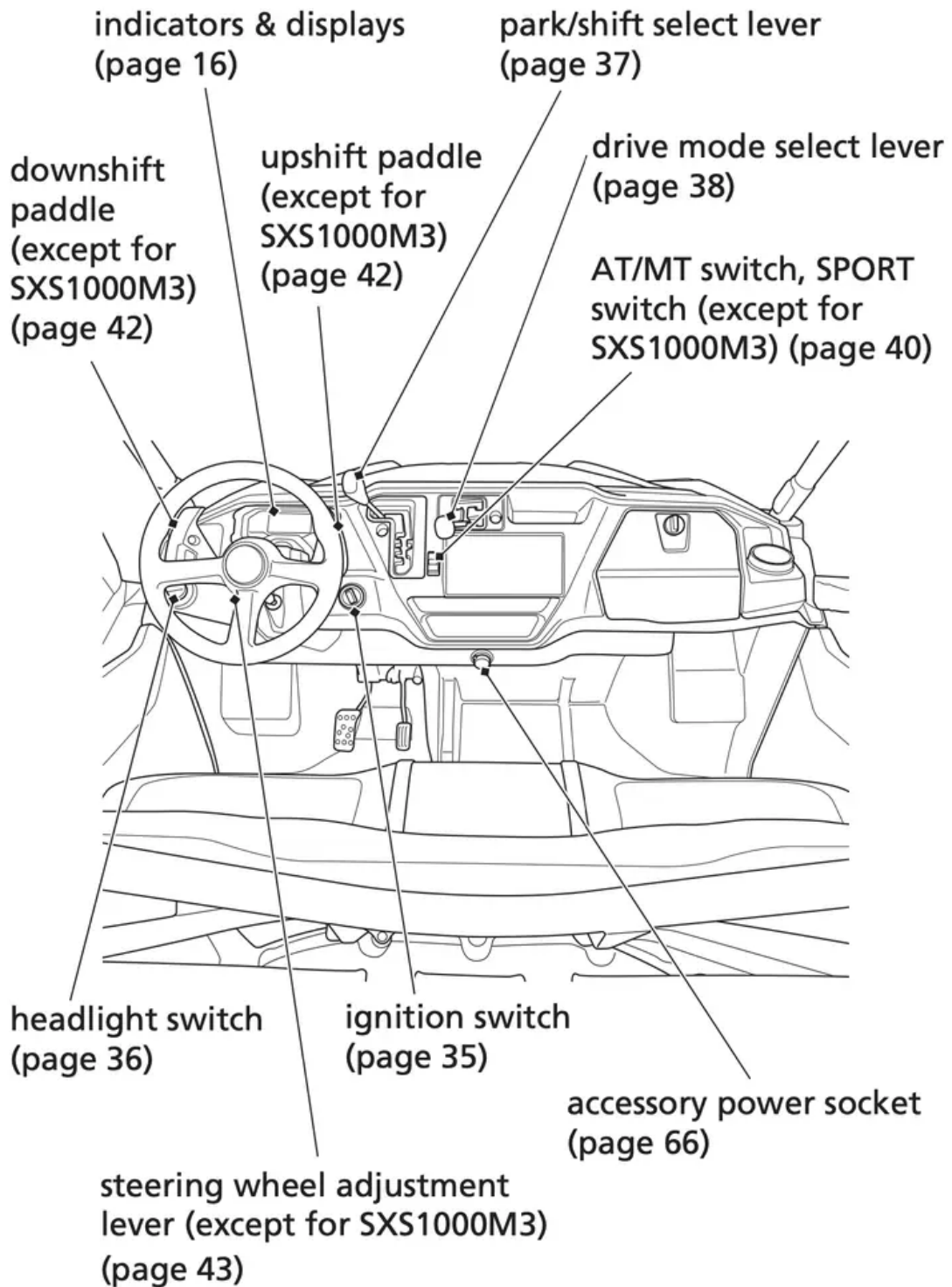

front side net (page 47)

passenger handhold (page 64)

front seat belt (page 58)

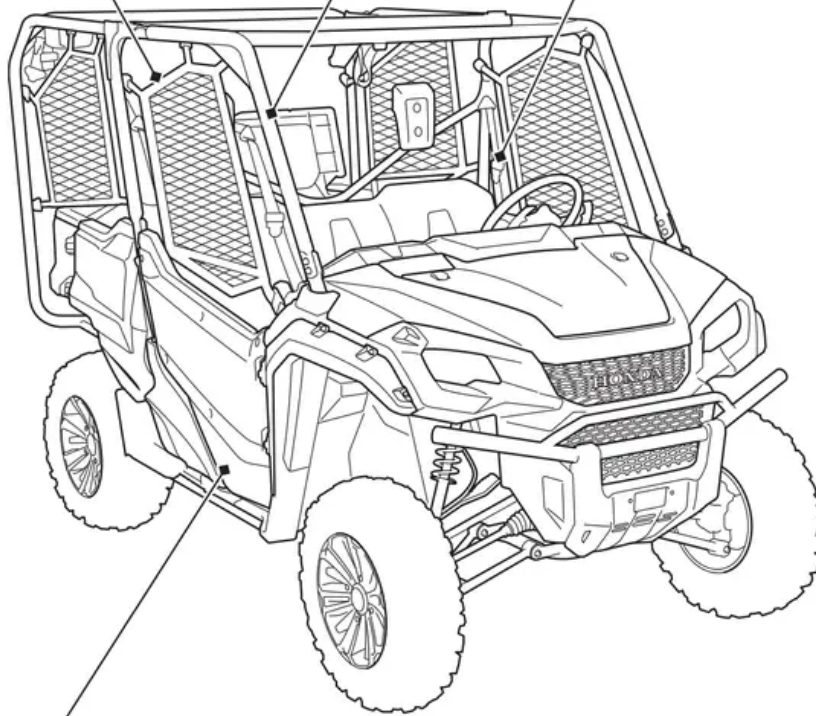

front door (page 45)



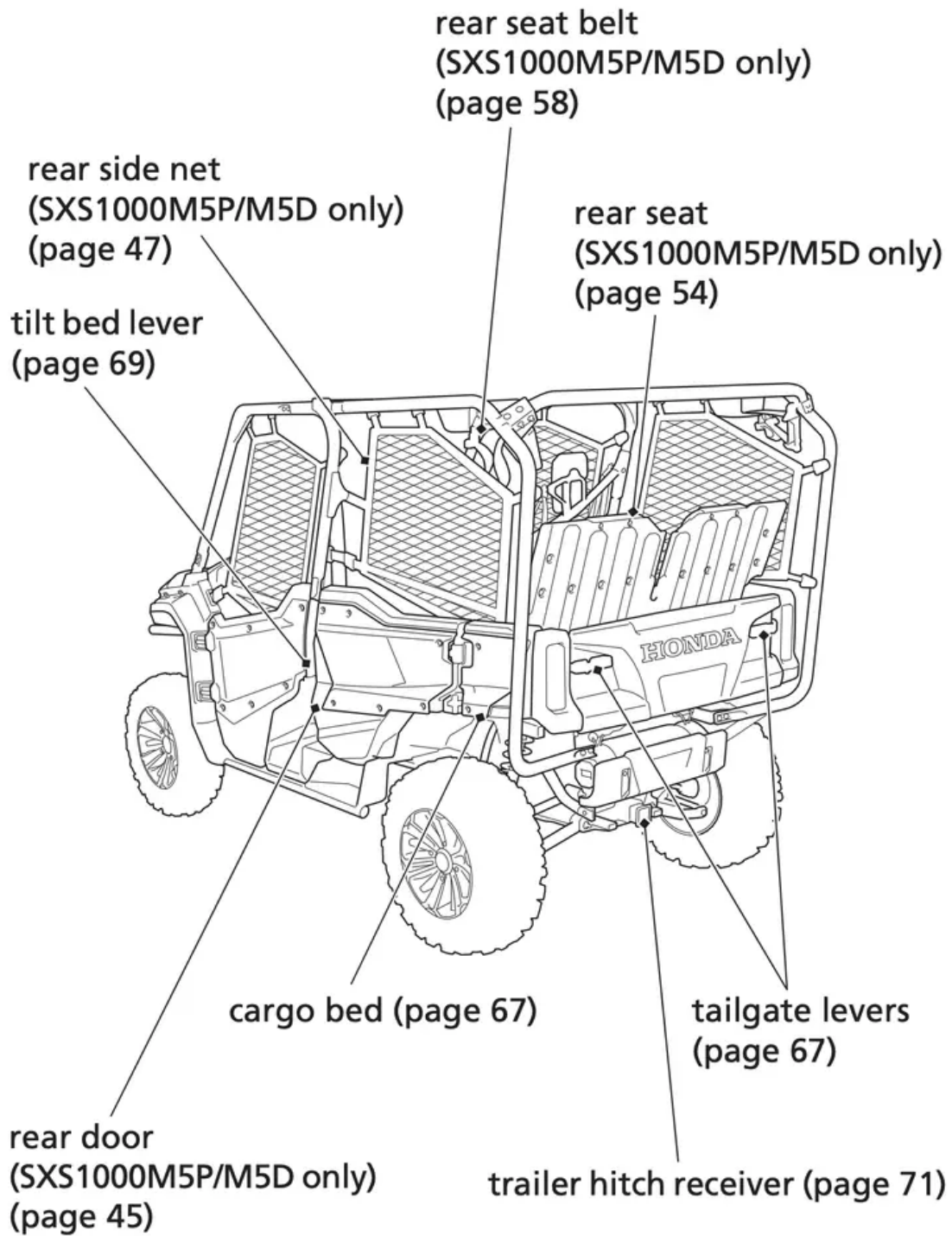

## Indicators & Displays

The indicators and displays on your Honda SXS keep you informed, alert you to possible problems, and make your driving safer and more enjoyable. Refer to the indicators frequently. Their functions are described on the following pages.

### Lamp Check

The indicators come on and go off sequentially when you turn the ignition switch to the ON (q) position.

If one of these indicators does not come on key ON check, have your dealer check for problems.

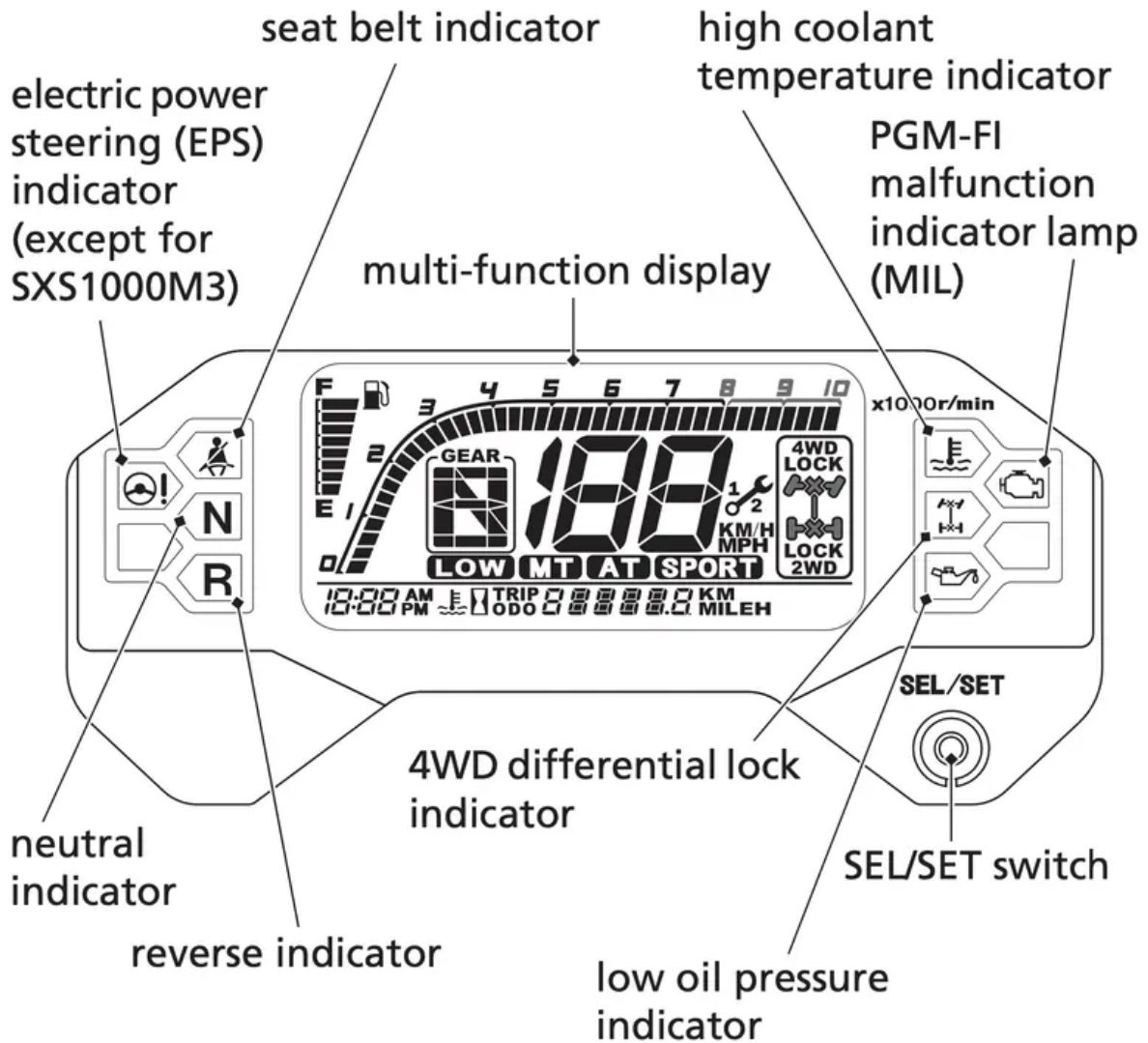

# N

## Neutral Indicator

This indicator comes on and stays on when the transmission is in neutral.

# R

## Reverse Indicator

This indicator comes on and stays on when the transmission is in reverse.





**Electric Power Steering (EPS) Indicator**  
(except for SXS1000M3)

This indicator comes on when the ignition switch is turned on and remains on until the engine is started.

This indicator comes on and stays on when there is abnormality in the electric power steering system.



**4WD Differential Lock Indicator**

This indicator will be on when the four-wheel differential gears are engaged (page 34).



**High Coolant Temperature Indicator**

This indicator comes on and stays on when the coolant temperature is high enough to adversely affect the service life of the engine. If this indicator comes on while you are driving, stop as soon as possible, turn the engine off, and let it cool.



**PGM-FI Malfunction Indicator Lamp (MIL)**

This indicator comes on and stays on when there is a problem with your vehicle's engine system. If this happens, reduce speed and take your vehicle to a dealer as soon as possible.



**Seat Belt Indicator**

This indicator starts blinking for few seconds, after initial display indication, when you turn the ignition switch to the ON (q) position to remind occupants to fasten their seat belts.



### Low Oil Pressure Indicator

This indicator comes on when the ignition switch is turned on and remains on until the engine is started.

This indicator comes on and stays on when the engine oil pressure is low enough to cause engine damage. If this indicator comes on while you are driving, stop as soon as possible, turn the engine off and check for oil leaks and oil level.

This indicator also comes on when the emergency valve is operated. (See more details about the emergency valve on page 225)

### Display Check

When the ignition switch is turned ON (q), the multi-function display will temporarily show all the modes and digital segments and initial message. So, you can make sure the liquid crystal display is functioning properly.

If any part of this display does not come on during the key ON check, have your dealer check for problems.

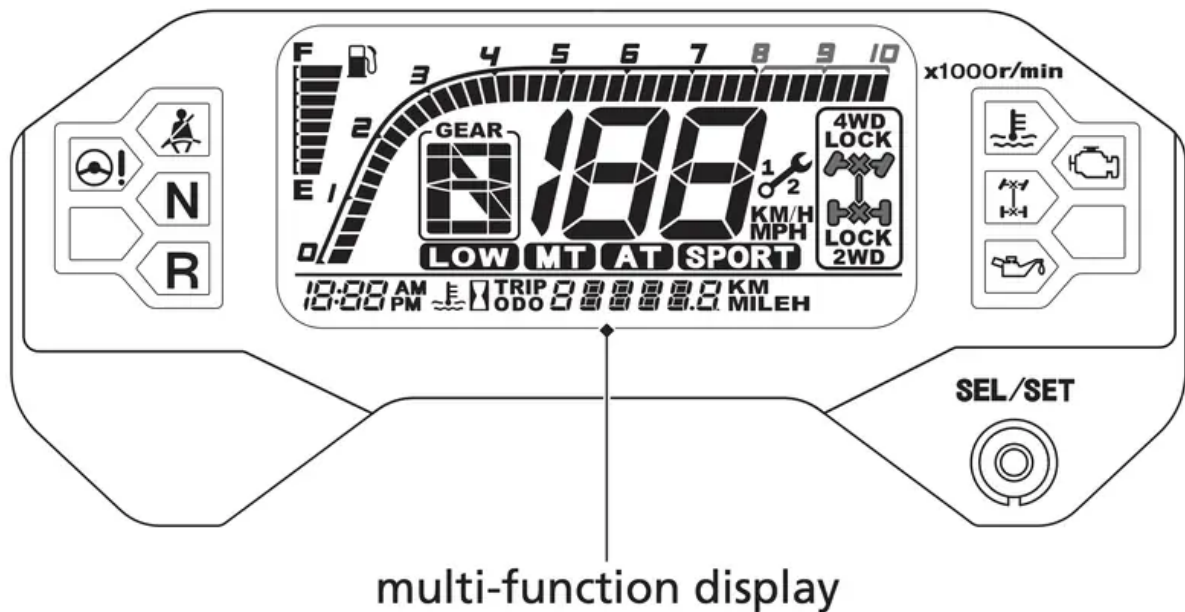

### Multi-function Display

The multi-function display consists of the following function displays:

- Speedometer
- Tachometer
- Fuel gauge



- Odometer display
- Maintenance minder indicator
- Digital clock
- Gear position indicator
- AT indicator
- MT/LOW indicators (except for SXS1000M3)
- SPORT indicator (except for SXS1000M3)
- Drive mode indicator

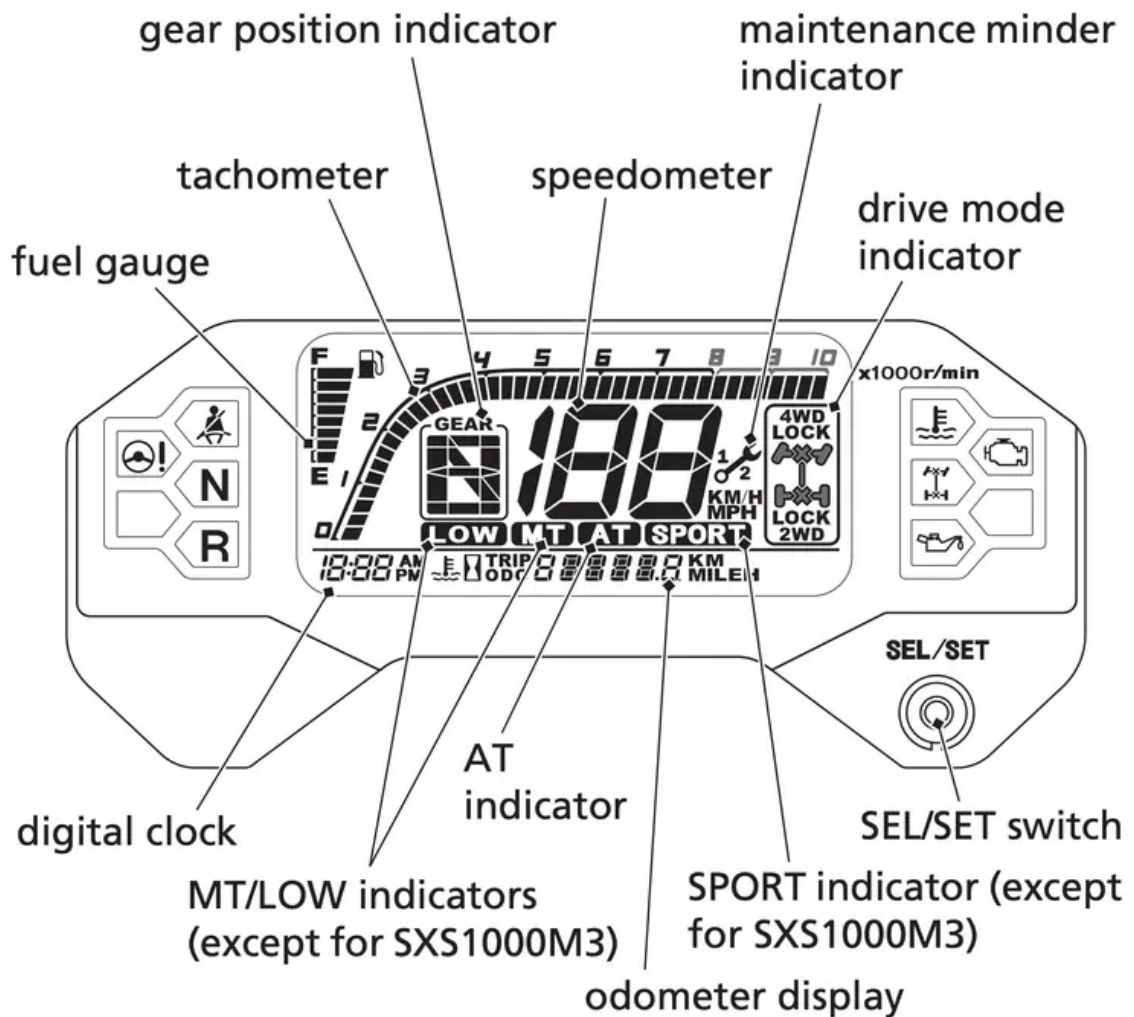

## Speedometer

This display shows speed in miles or kilometers per hour.

### Mileage Unit Change

The speedometer, odometer, tripmeter and maintenance tripmeter show in either “MPH” and “MILE” or “KM/H” and “KM”.

To change the mileage unit, press and hold the SEL/SET switch for more than 5 seconds in odometer mode (page 25) with the vehicle stopped.

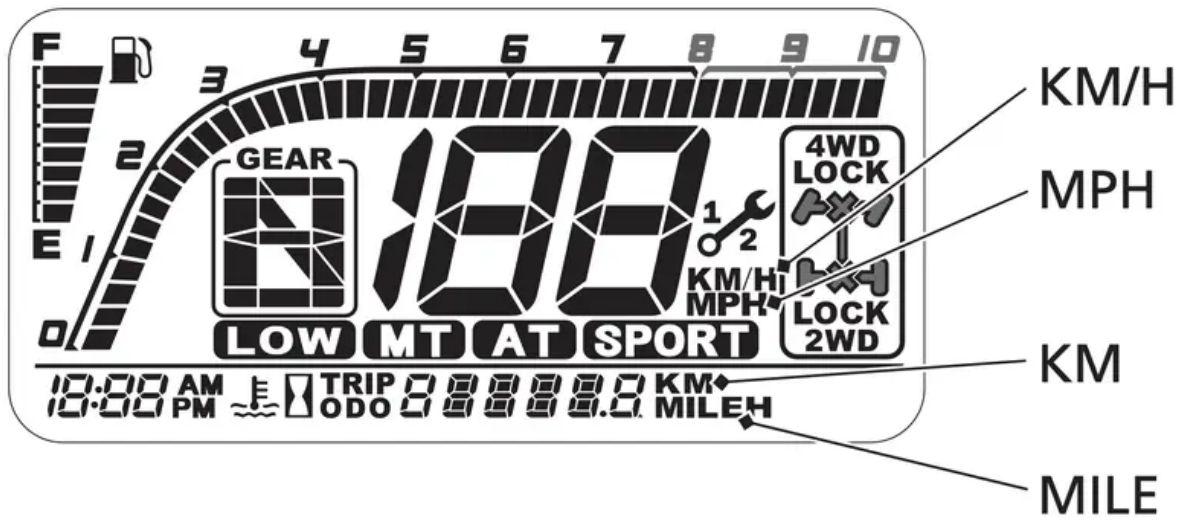

### SEL/SET

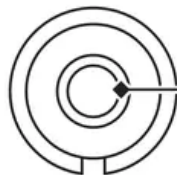

SEL/SET switch

### Tachometer

This display shows the engine speed in revolutions per minute (rpm). Do not operate the engine in the tachometer red zone. Excessive engine speed can adversely affect engine life.

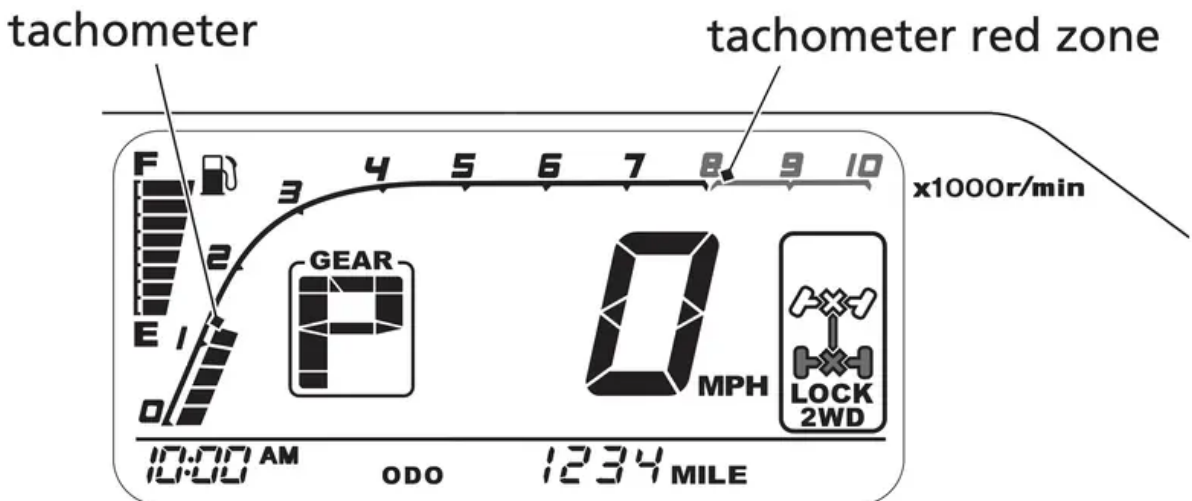

## Odometer Display

This display includes odometer, tripmeter, coolant temperature gauge, hourmeter, maintenance tripmeter, and maintenance hourmeter.

Each time you press the SEL/SET switch, mode will change as shown in the illustration.

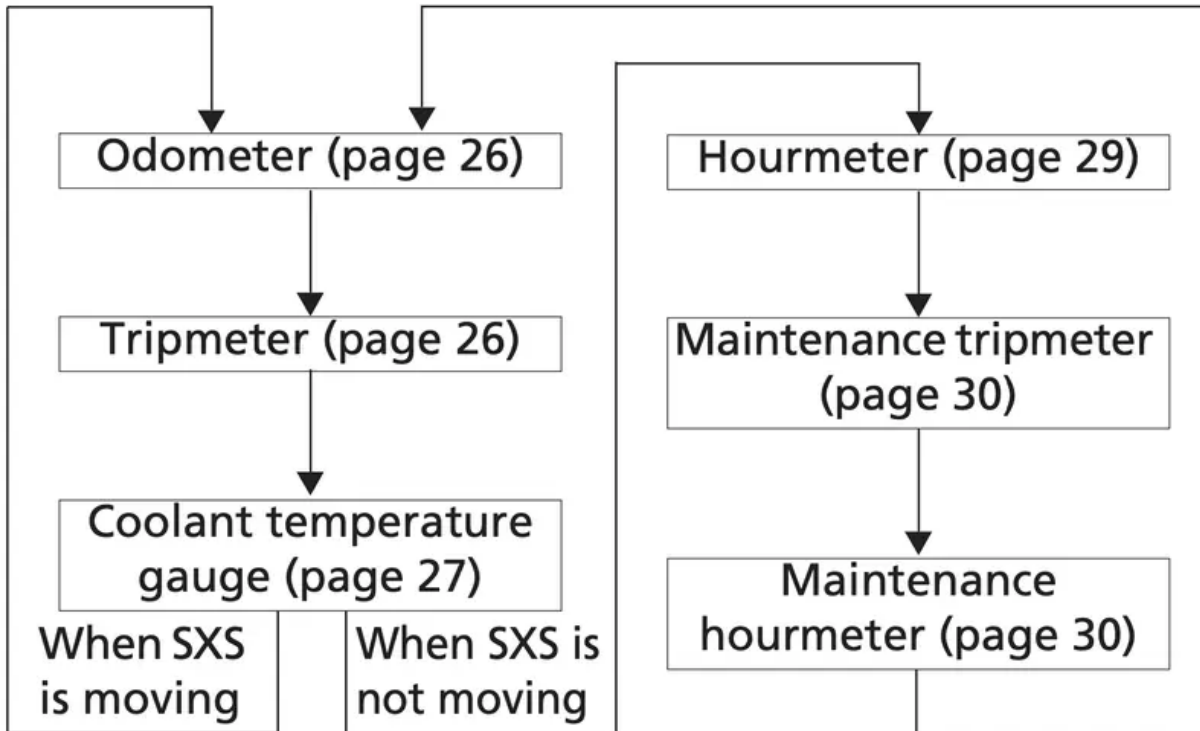

If there are unusual indications with your SXS, and SEL/SET switch is not pressed for 10 seconds, a message will automatically appear in the display.

### Odometer

The odometer shows the total miles or kilometers ridden with the ODO display. The odometer locks at 999,999 when the readout exceeds 999,999.

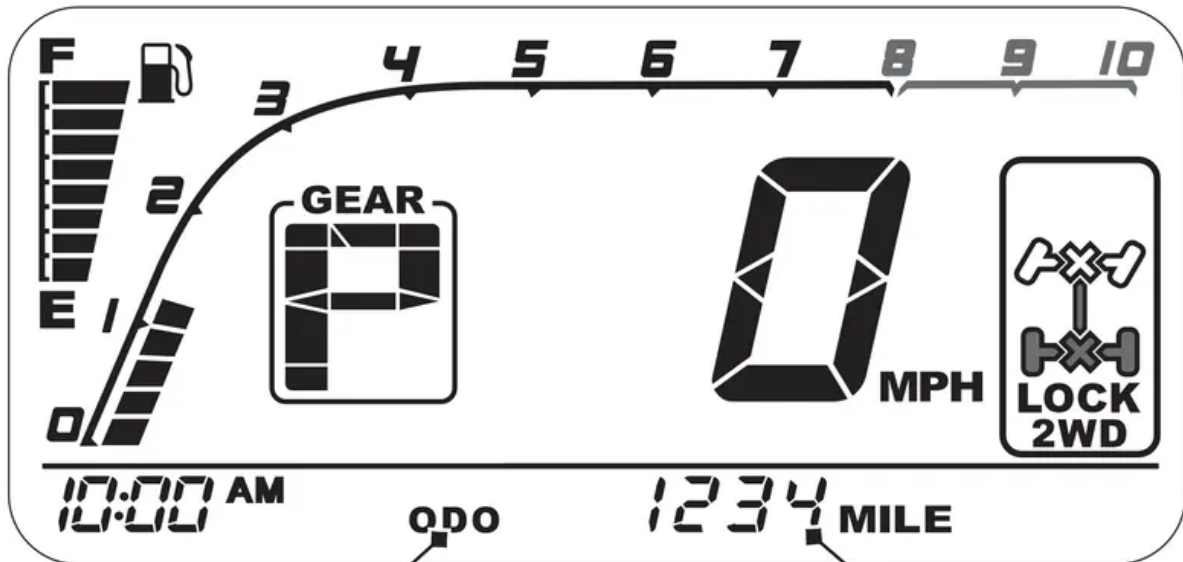

ODO display

odometer

Tripmeter

The tripmeter shows the number of miles or kilometers ridden with the TRIP display, since you last reset the tripmeter. The tripmeter returns to 0.0 when the read-out exceeds 999.9.

To reset the tripmeter, press and hold the SEL/SET switch with the display in the tripmeter mode.

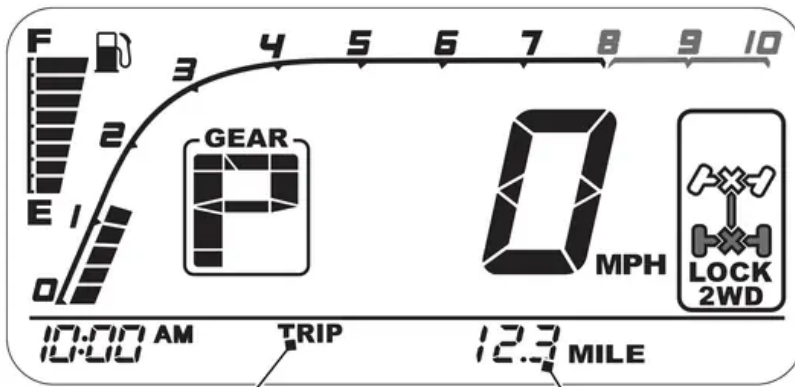

TRIP display

tripmeter

**SEL/SET**



SEL/SET switch

Coolant temperature gauge

The coolant temperature gauge shows engine coolant temperature with the coolant temperature display. When the segment begins to move above the C (Cold) display, the engine is warm enough for the SXS to be ridden. When the coolant temperature is low, the coolant temperature gauge will



display “Lo”. The normal operating temperature range is within the section between the H and C displays.

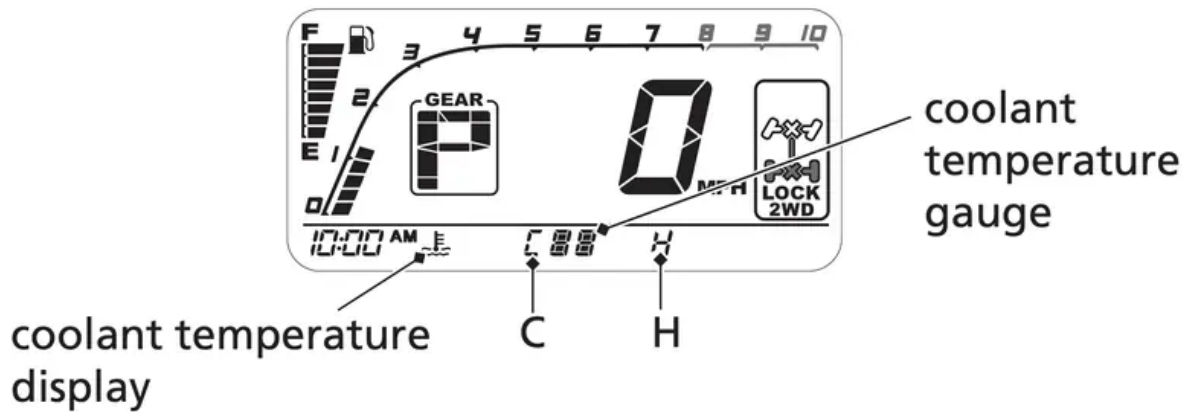

If all sections of the coolant temperature gauge, including segment H and high coolant temperature indicator are on (automatically appears in the display), stop the engine and check the reserve tank coolant level.

Read pages 230 – 231 and do not drive the SXS until the problem has been corrected.

**NOTICE:** Continuing to ride with an overheated engine can cause serious engine damage.

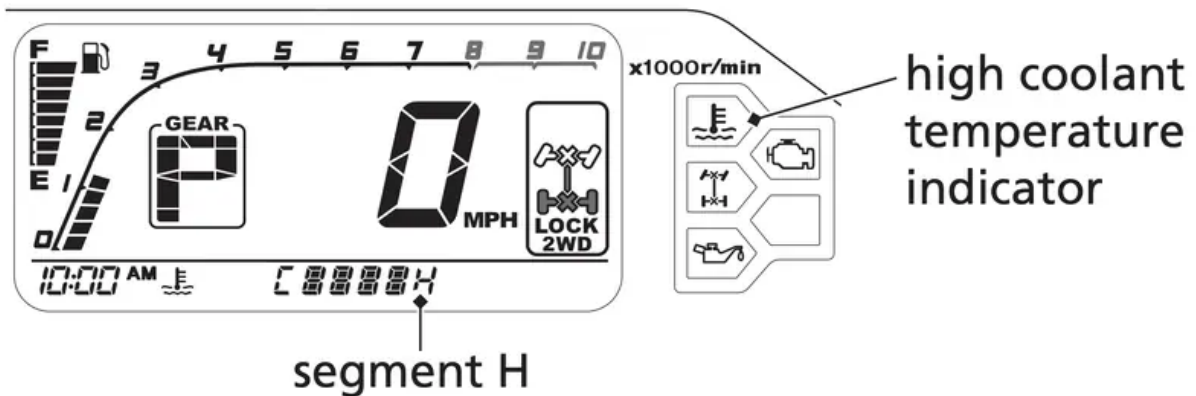

Coolant temperature gauge failure:

If the coolant temperature system has an error, the coolant temperature gauge will blink and appear in the display, and high coolant temperature indicator will be turned on.

If this occurs, see your dealer as soon as possible.

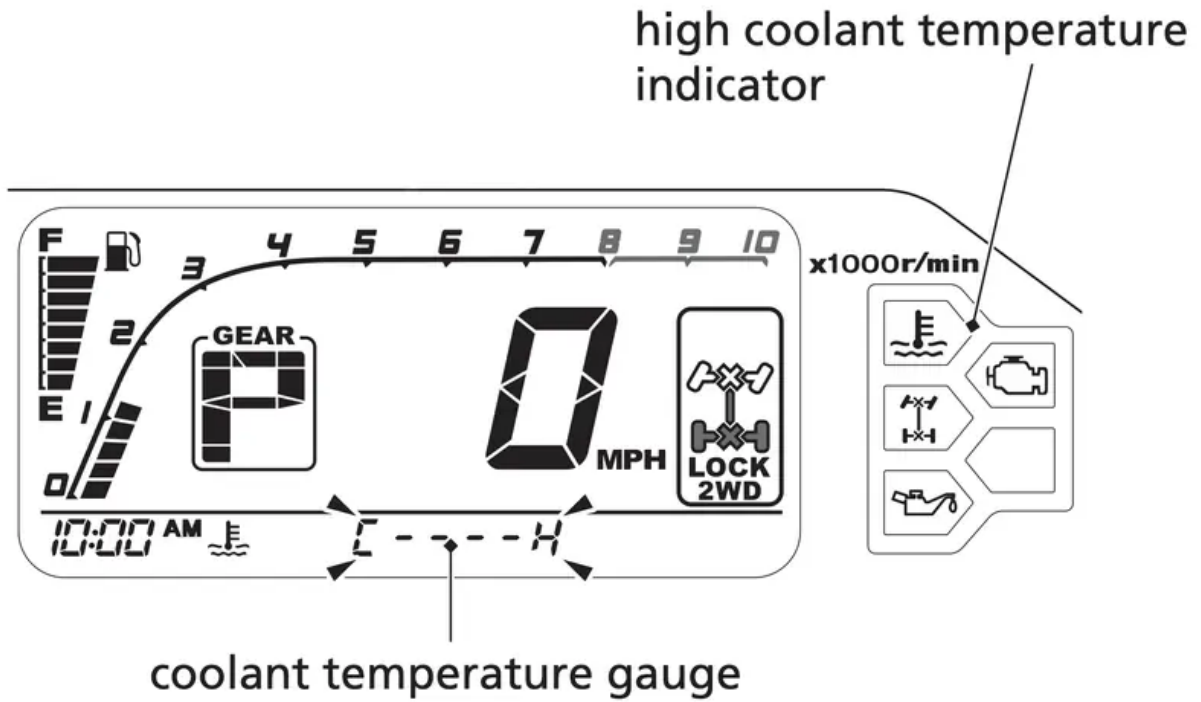

### Hourmeter

The hourmeter display shows accumulated hours while the ignition is ON (q). The hourmeter locks at 99,999.9 when the readout exceeds 99,999.9.

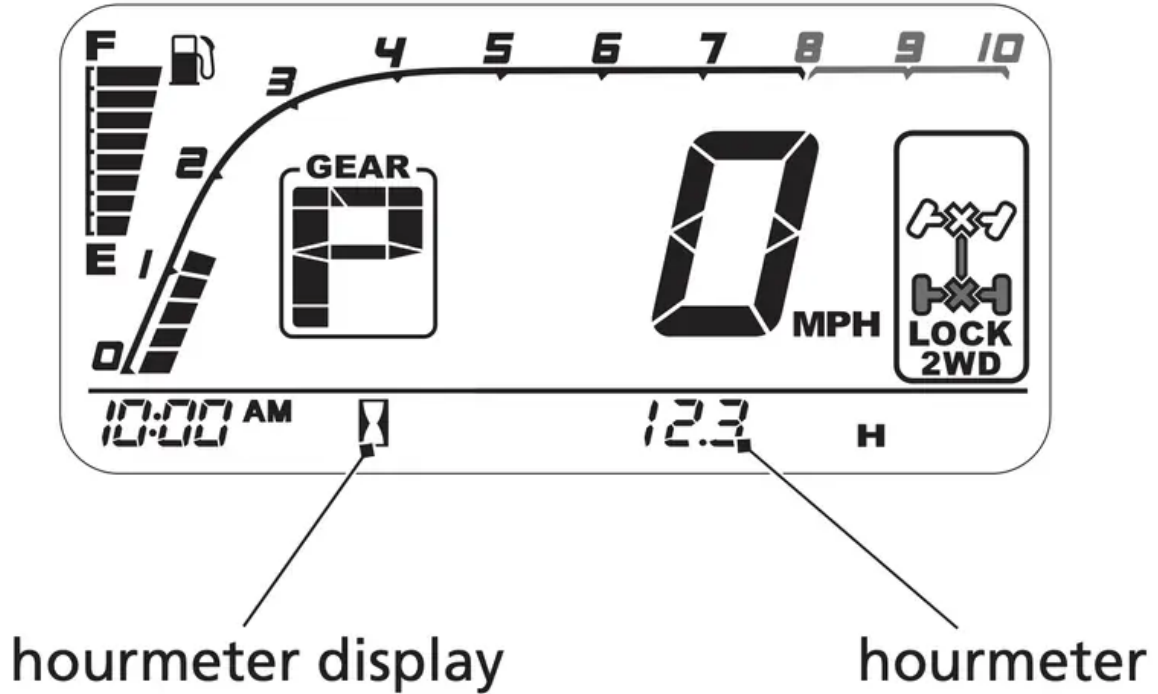

## Maintenance Minder Indicator

The maintenance minder indicator appears in the display when the mileage or operating hours on your Honda SXS reaches the maintenance interval specified on the maintenance schedule (page 115).

Reset the indicator after each scheduled maintenance is performed. If the scheduled maintenance is performed before the maintenance minder indicator appears, be sure to reset the maintenance minder after performing the scheduled maintenance.

Resetting the indicator:

To reset the indicator, press and continue to hold the SEL/SET switch and turn the ignition switch to ON (q). The indicator message will light up, and after 2 seconds will blink twice, the maintenance minder indicator is reset.

Also the maintenance tripmeter and maintenance hourmeter will reset.

See more details about maintenance minder indicator on page 113.

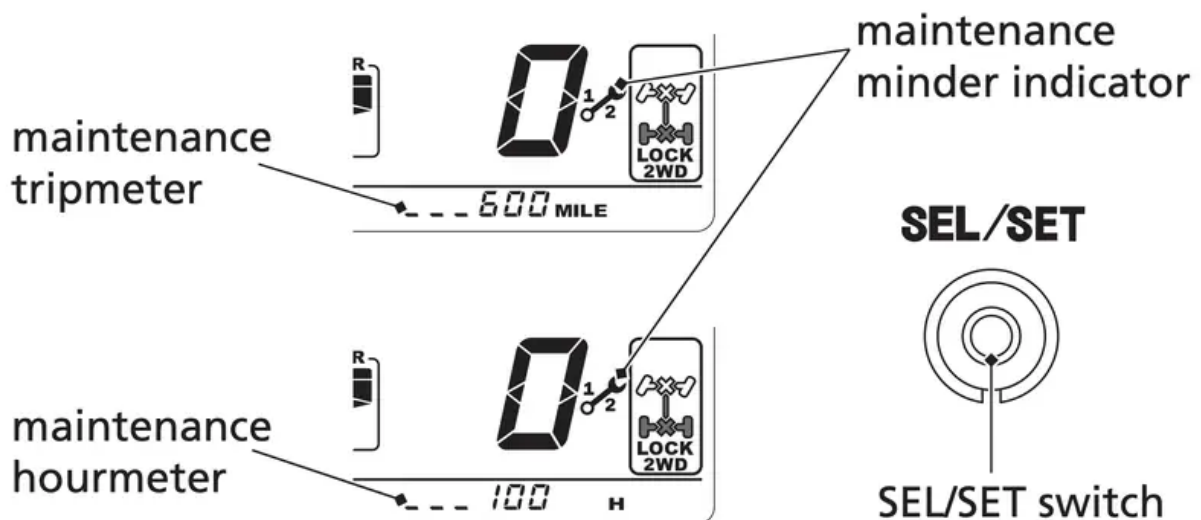

## Digital Clock

The digital clock shows the hour and minutes with the 12-hour clock display.

To set the time:

1. Turn the ignition switch to ON (q).
2. Change the hourmeter display (page 25).
3. Press and hold the SEL/SET switch. The clock will start blinking.
4. Press and hold the SEL/SET switch until the desired time appears.
5. To complete setting the clock, press the SEL/SET switch, or turn the ignition switch OFF (w).



### Gear Position Indicator

The gear position indicator shows the selected shift position by the shift select lever (page 37).

The indicator displays: P for park, N for neutral, R for reverse, H for high-range, L for low-range, and 1 – 6 for gear positions (shift paddles operation)

“–” will be displayed on the gear position indicator when the transmission is not shifted into gear properly. Before driving, check that the gear position is properly displayed on the gear position indicator.

If the gear position indicator blinks, see If the Transmission Is Not Functioning Properly, page 223.

## gear position indicator

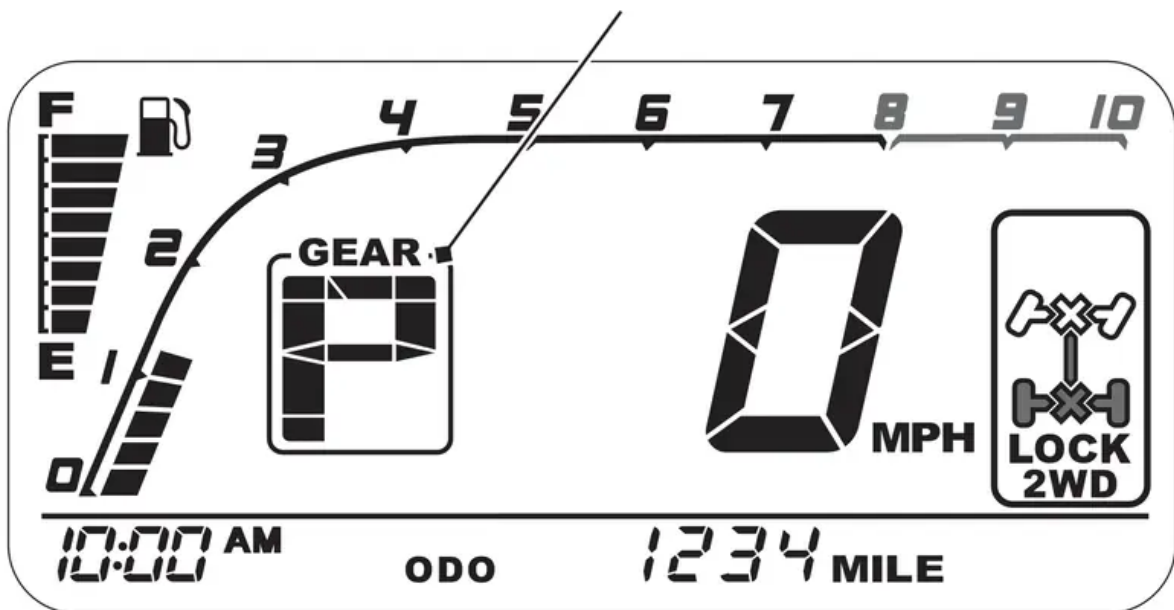

## AT Indicator, MT Indicator / LOW Indicator (except for SXS1000M3)

These indicators display the transmission mode of the SXS.

The indicators display: AT for automatic shift mode, MT for manual shift mode (except for SXS1000M3).

To switch between AT mode and MT mode, press the AT/MT switch (page 40). When MT mode is selected in low-range (L), the LOW indicator also comes on.

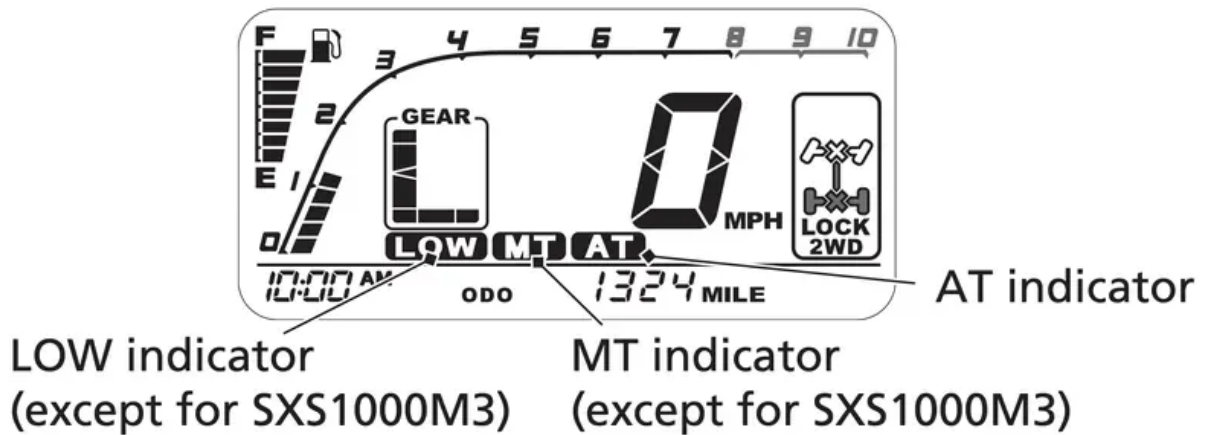

## SPORT Indicator (except for SXS1000M3)

When AT mode is selected, pressing the SPORT switch displays the SPORT indicator (page 41).

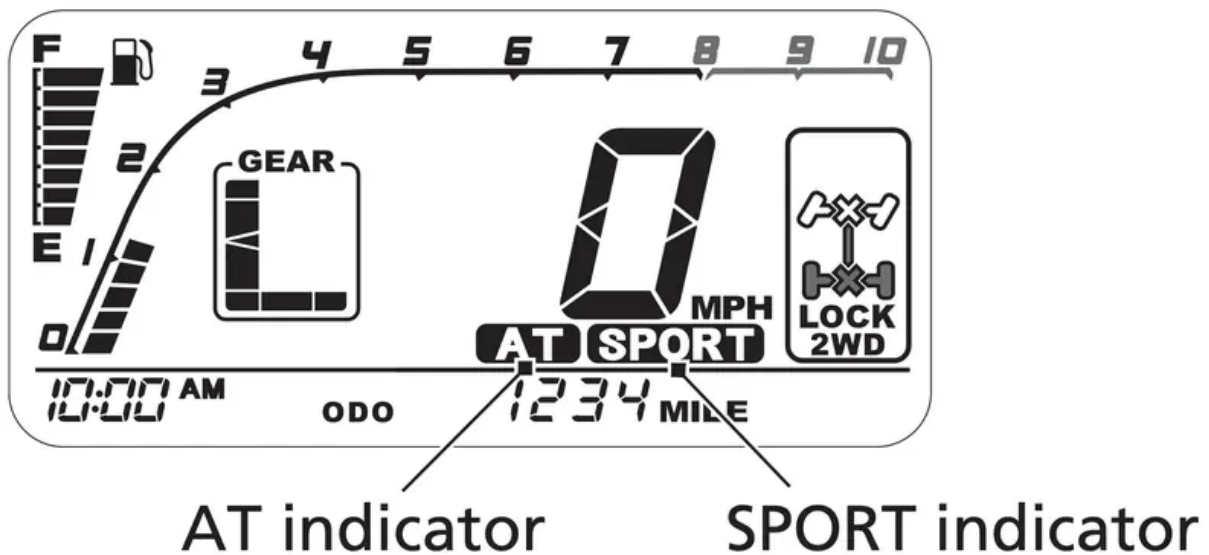

## Drive Mode Indicator

The drive mode indicator shows the selected drive mode by the drive mode select lever (page 38).

### 4WD differential lock indicator

This indicator comes on when the differential gears are engaged.

drive mode indicator

4WD differential lock indicator

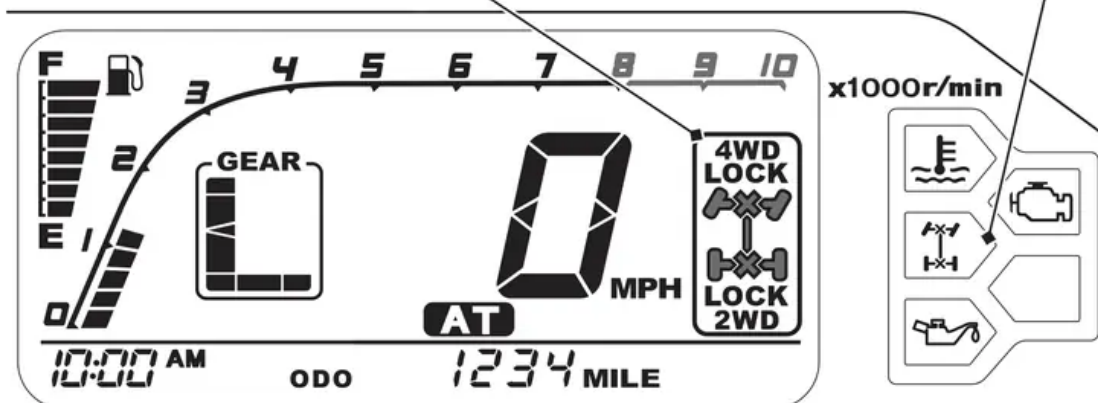

drive mode select lever position	<b>Turf</b>	<b>2WD</b>	<b>4WD</b>	<b>4WD Diff Lock</b>
drive mode indicator				
4WD differential lock indicator	No indicator light.			

## Driver Controls

### Ignition Switch

The ignition switch is a three-position, key-operated switch used to start and stop the engine.

**OFF (w)** — The engine and all electrical circuits are off. The key can be inserted and removed only when it is in this position.

**ON (q)** — The electrical circuits are on. You can use the accessory power socket in this position.

**START (p)** — This position is used only to start the engine. The key will automatically return to the ON (q) position when you let go of it.

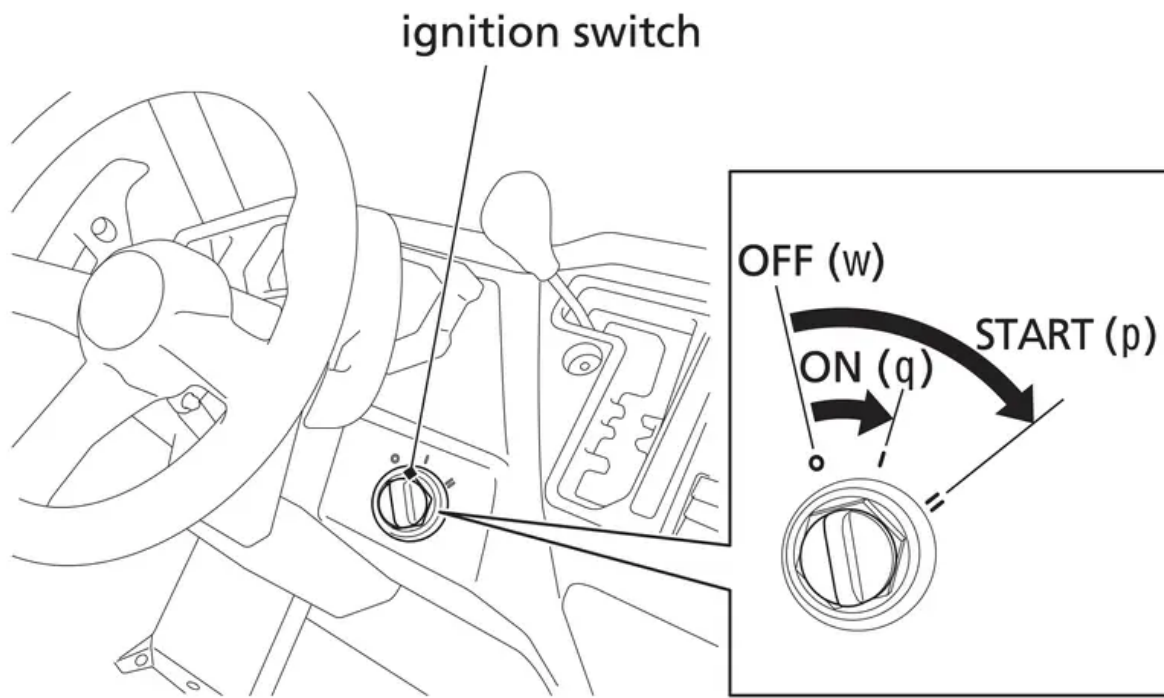

## Headlight Switch

The headlight switch is located on the front console, to the left of the steering wheel. This switch turns the headlights and taillights on and off, and changes between low beam or high beam.

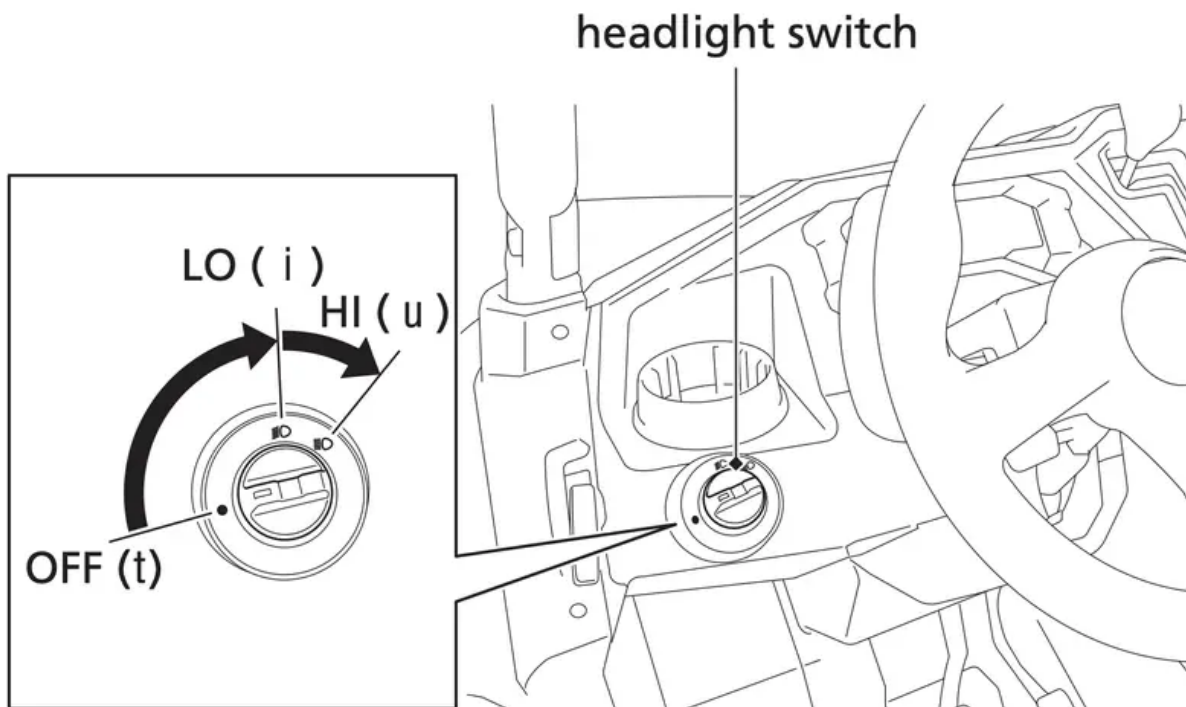

**OFF (t)** — The headlights and taillights are off.

**LO (i)** — The headlights and taillights are on. The headlights are low beam.

**HI (u)** — The headlights and taillights are on. The headlights are high beam.

## Shift Select Lever

Your Honda SXS is equipped with an automatically controlled 6-speed transmission. The shift select lever, located to the right of the steering wheel, has five positions: park (P), reverse (R), neutral (N), high-range (H), and low-range (L).

shift select lever

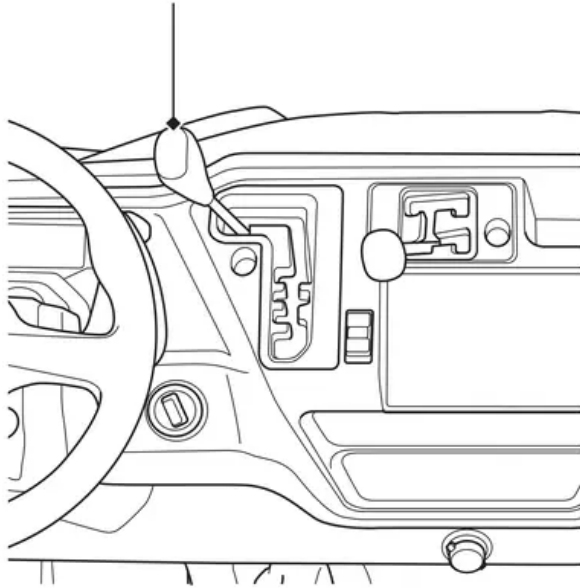

shift positions

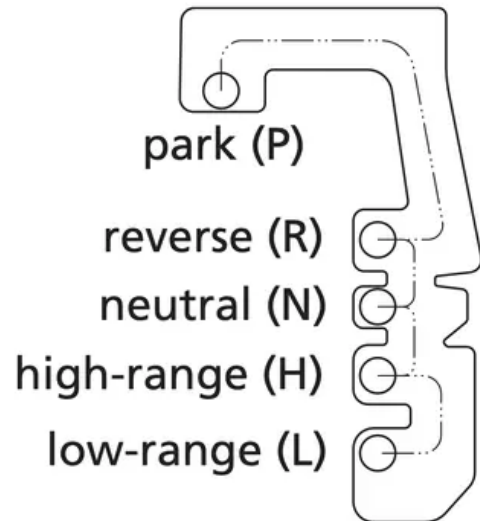

You should move the shift select lever only when the vehicle is stopped with your foot on the brake pedal and with the engine idling. Use a firm motion to select the appropriate gear. Have your vehicle checked by a dealer if you experience any shifting problems.

**NOTICE:** Do not attempt to move the shift select lever with the engine speed above idle or while the vehicle is moving, as you may damage the transmission.

## Drive Mode Select Lever

The drive mode select lever, located to the right of the shift select lever, has four drive mode positions: Turf, 2WD, 4WD and 4WD Diff Lock.

drive mode select lever

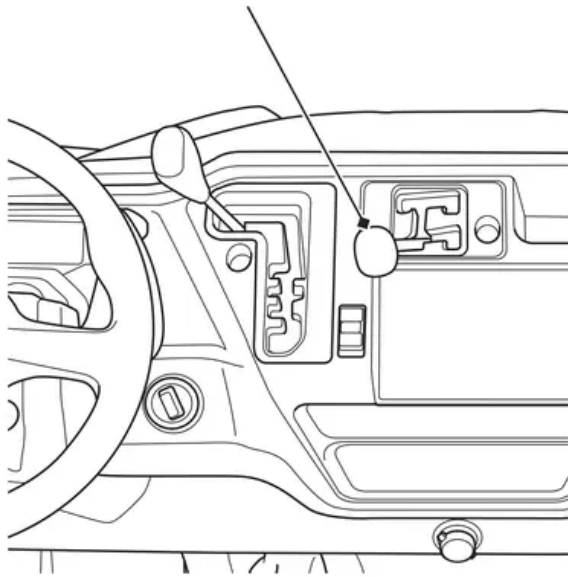

drive mode positions

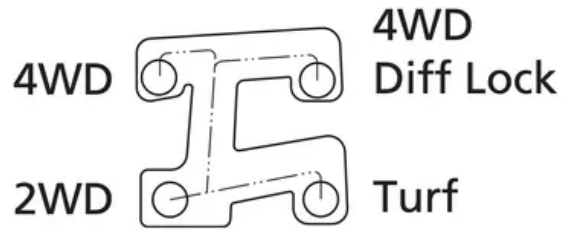

To check your present drive mode, look at the drive mode indicator and 4WD differential lock indicator.

drive mode select lever position	Turf	2WD	4WD	4WD Diff Lock
drive mode indicator				
4WD differential lock indicator	No indicator light.			

You should change drive modes only when the vehicle is stopped and the engine is idling.

**NOTICE:** Changing drive modes while the vehicle is moving could damage the drivetrain.

After changing the drive mode, drive several yards, making right and left turns, and make sure that indicators work properly. If the indicators do not go out or come on according to the drive mode position, see your dealer.

### AT/MT Switch (except for SXS1000M3)

The AT/MT switch is located on the right side of the shift select lever. When the shift select lever is in the high range (H) or low range (L) position, you can switch between AT mode and MT mode by pressing the AT/MT switch.



## AT/MT switch

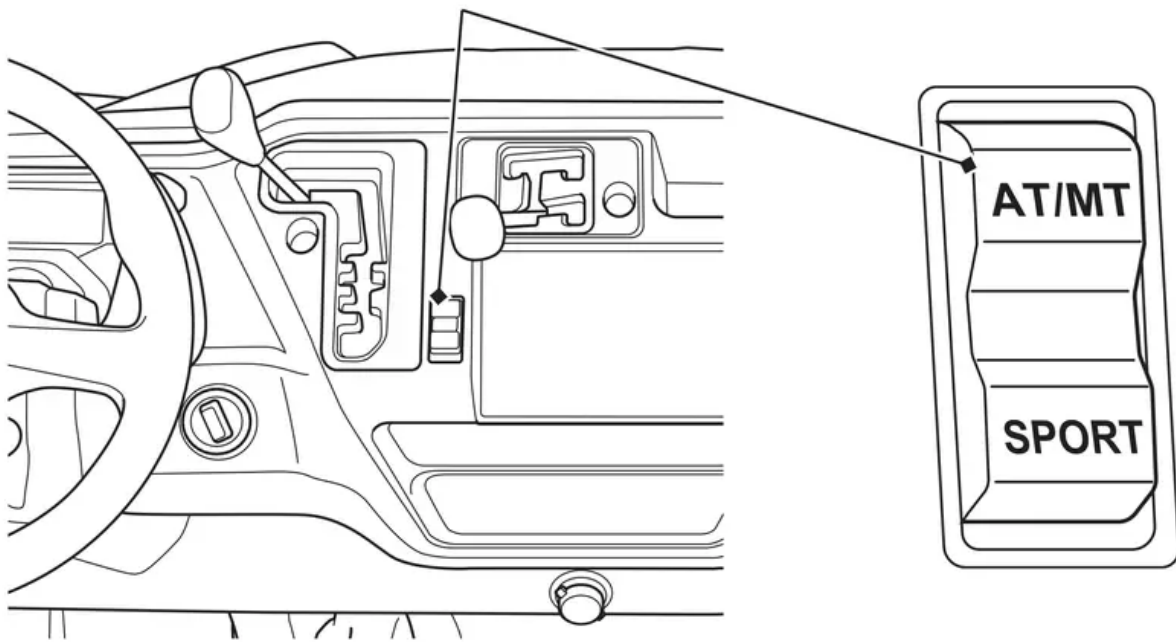

### **SPORT Switch (except for SXS1000M3)**

The SPORT switch is below the AT/MT switch.

When AT mode is selected and the shift select lever is in the highrange (H) position, you can switch between turning SPORT mode on and off by pressing the SPORT switch.

When the shift select lever is in the low-range (L) position, SPORT mode will not turn on even if the SPORT switch is pressed.

When MT mode is selected, SPORT mode will not turn on even if the SPORT switch is pressed.

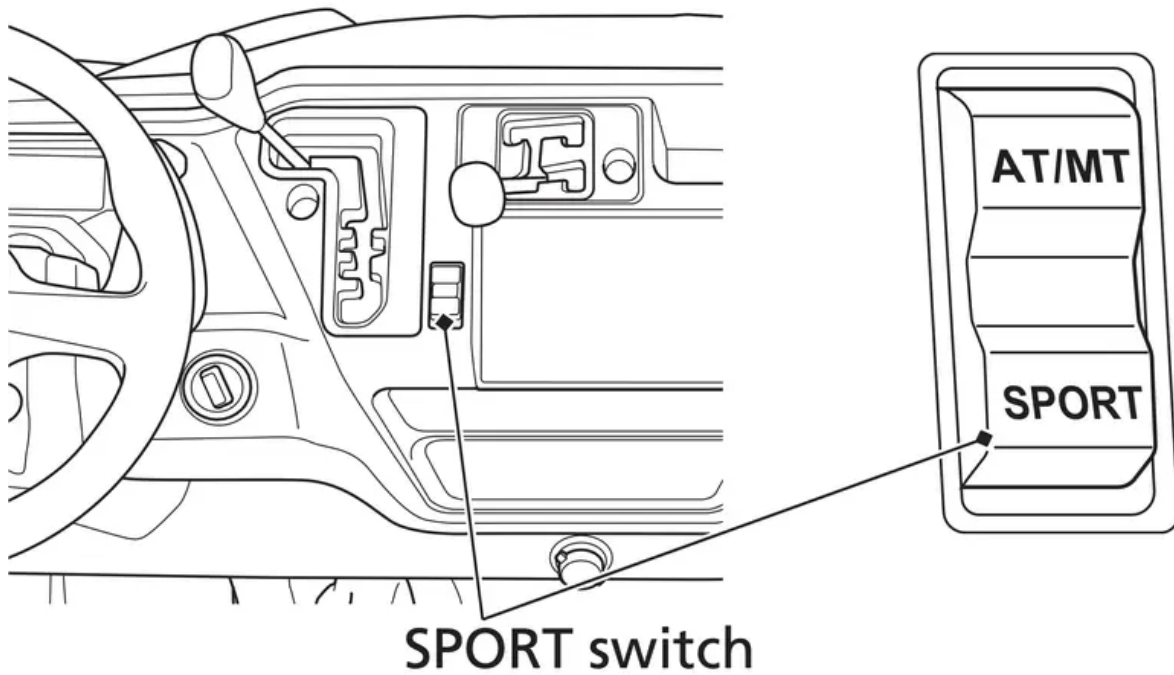

### Shift Paddles (except for SXS1000M3)

Your Honda SXS is equipped with a pair of shift paddles that are located behind the steering wheel.

downshift paddle (-)

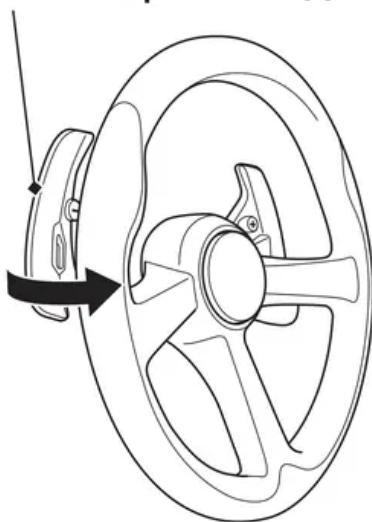

upshift paddle (+)

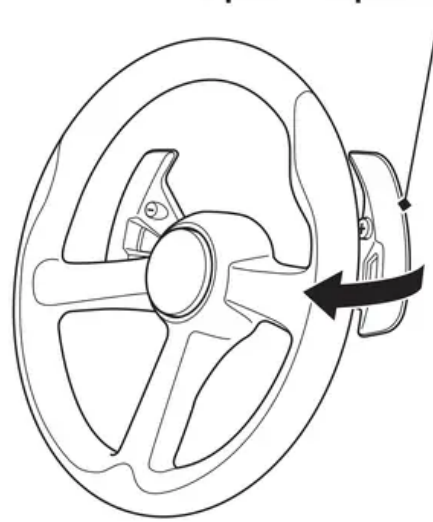

Pull the upshift paddle (+) to shift to a higher gear position and the downshift paddle (-) to shift to a lower gear position.

In MT mode, the shift paddles are operated to drive the SXS.

In AT mode, you can drive the SXS without operating the shift paddles. You can also operate the shift paddles to temporarily change the gear position. (See page 88 for more information)

## Steering Wheel Adjustment Lever (except for SXS1000M3)

Your Honda SXS is equipped with an height-adjustable steering wheel. Adjust the steering wheel position so that you can comfortably grip the steering wheel in an appropriate driving posture.

**NOTICE:** Do not adjust the steering wheel position while driving.

Adjusting while driving will move the steering wheel position and may cause you to lose control of the vehicle. Make sure to adjust the steering wheel only when the vehicle is stopped.

**NOTICE:** The steering wheel position damper unit contains high pressure nitrogen gas. Do not attempt to disassemble, service, or improperly dispose of the damper. See your dealer.

### Adjust

1. Hold the steering wheel and pull the steering wheel adjustment lever up towards you.
2. While pulling the steering wheel adjustment lever towards you, adjust the steering wheel position.  
Make sure you can see the gauges and indicators at the adjusted position.
3. Release the steering wheel adjustment lever.
4. After adjusting the position, make sure you have securely locked the steering wheel in place by trying to move it up and down.

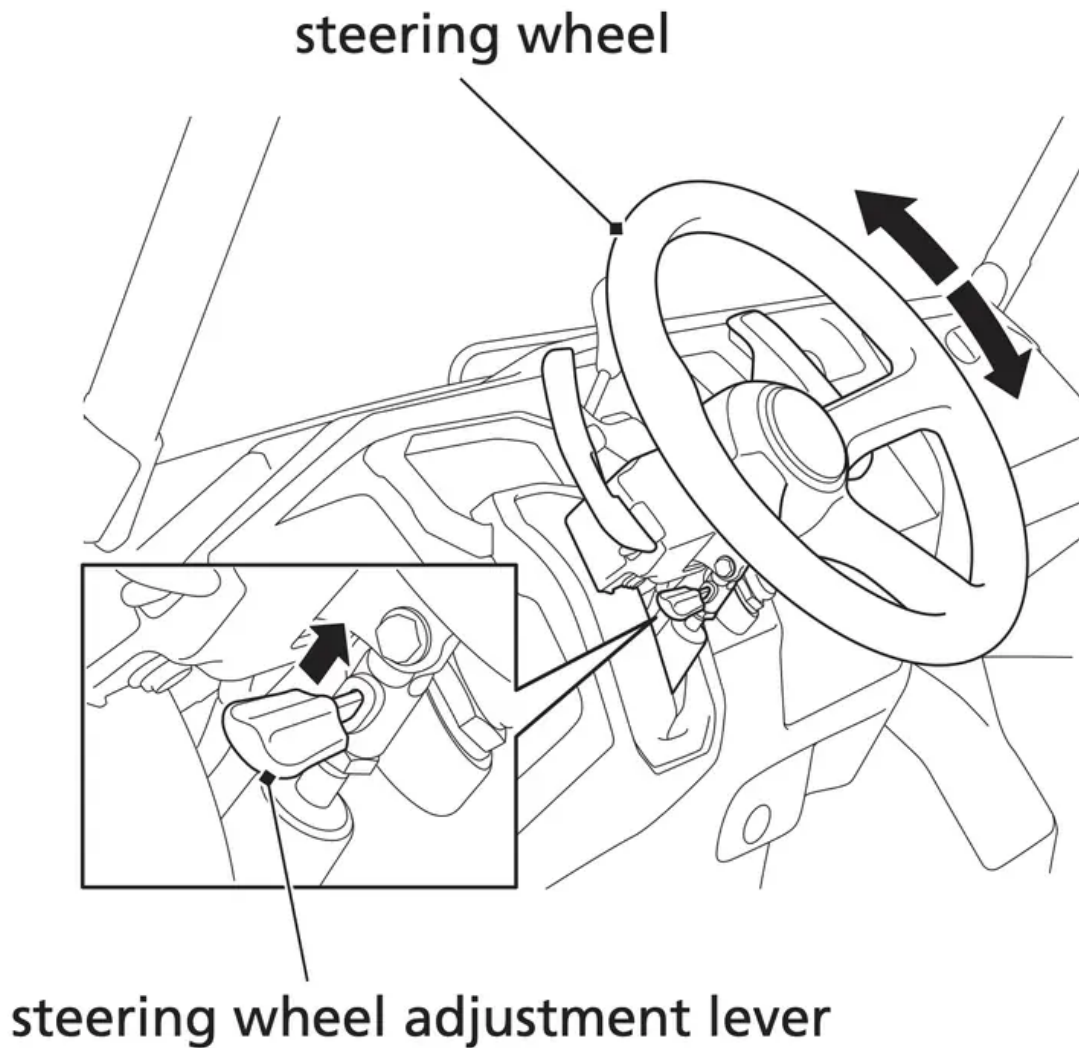

## Doors

Your Honda SXS is equipped with doors to prevent branches, gravel, or other debris from getting inside the driver's compartment, and to keep the driver's and passenger's legs and feet inside the vehicle if your vehicle ever tips or overturns. Be sure all doors are securely closed before driving your Honda SXS, and never remove a door.

If a door is damaged or does not close securely, see your dealer for repair or replacement.

Do not drive the Honda SXS with the doors open or removed.

SXS1000M5P/M5D only Do not open the rear door while the cargo bed is raised. Opening the rear doors while the cargo bed is raised, will cause the seats to flip up unexpectedly.

The left and right doors can be opened in the same manner.

### Open

1. Pull up the handle.

2. Open the door.

### Close

1. Close the door securely until the second latch click is heard.
2. Make sure the door is closed securely.

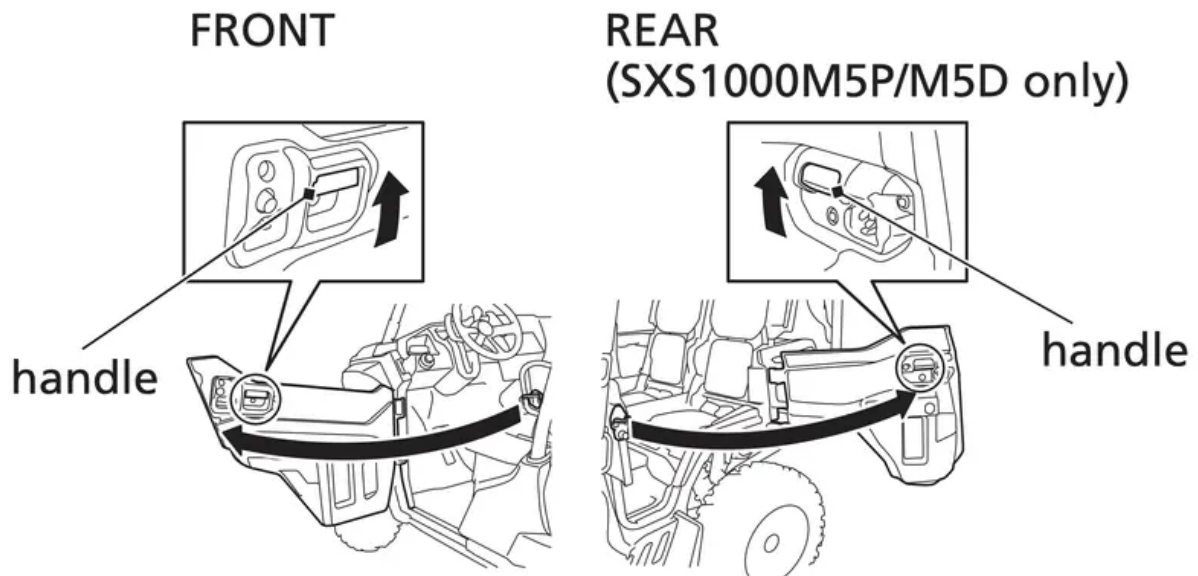

If the doors rattle when closed, turn the door stopper counterclockwise to adjust the doors. Each door has a double latching mechanism. Adjust the door stoppers so that it latches on the second click.

The left and right doors can be adjusted in the same manner.

### Adjust

1. Open the door (page 45).
2. Turn the door stopper counterclockwise to extend it, and clockwise to retract it.
3. Make sure the door is closed securely until the second latch click is heard.

## FRONT

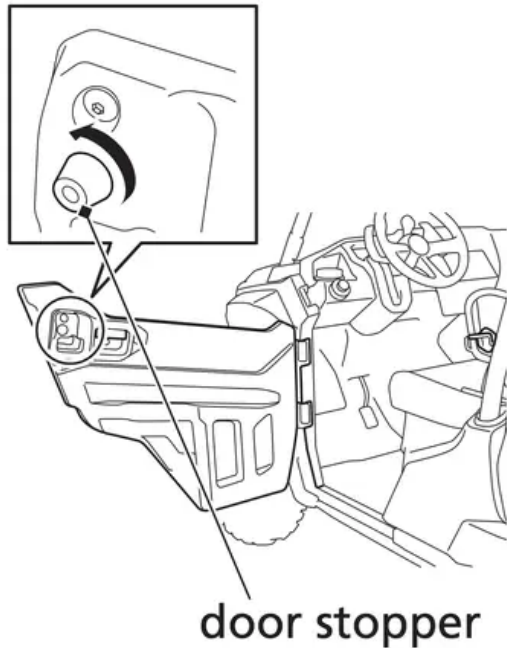

## REAR (SXS1000M5P/M5D only)

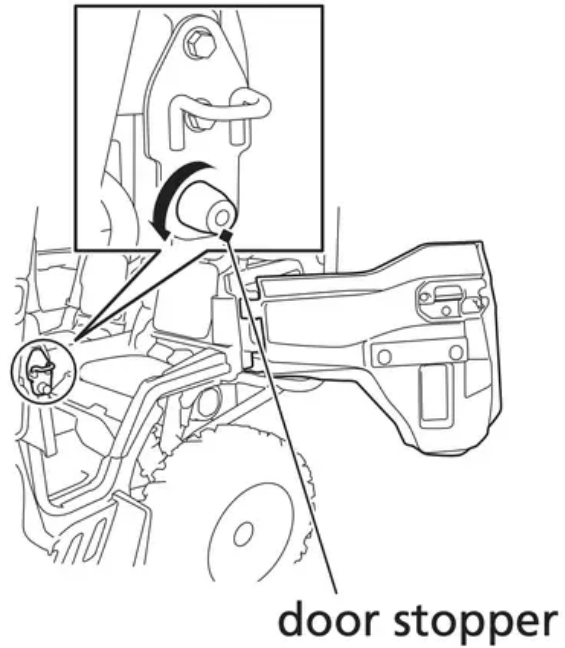

## Seat Belts

Your Honda SXS is equipped with lap/shoulder seat belts in each seating position. A seat belt keeps you connected to the vehicle so you won't be thrown out during a crash or rollover. Together with a proper helmet, a seat belt is your best protection against serious injuries in any type of crash, so make sure all occupants always buckle up before driving.

### **WARNING:**

- Not wearing a seat belt, or wearing one improperly, can result in serious injury or death in a crash or rollover.
- Make sure the driver and any passengers always wear their seat belts properly.

Of course, seat belts cannot completely protect you in every crash. But in most cases, seat belts can reduce your risk of serious injury.

How you wear a seat belt also matters. For the best protection:

## Front

1. Insert the latch plate into the buckle, then tug on the belt to make sure it is securely latched.

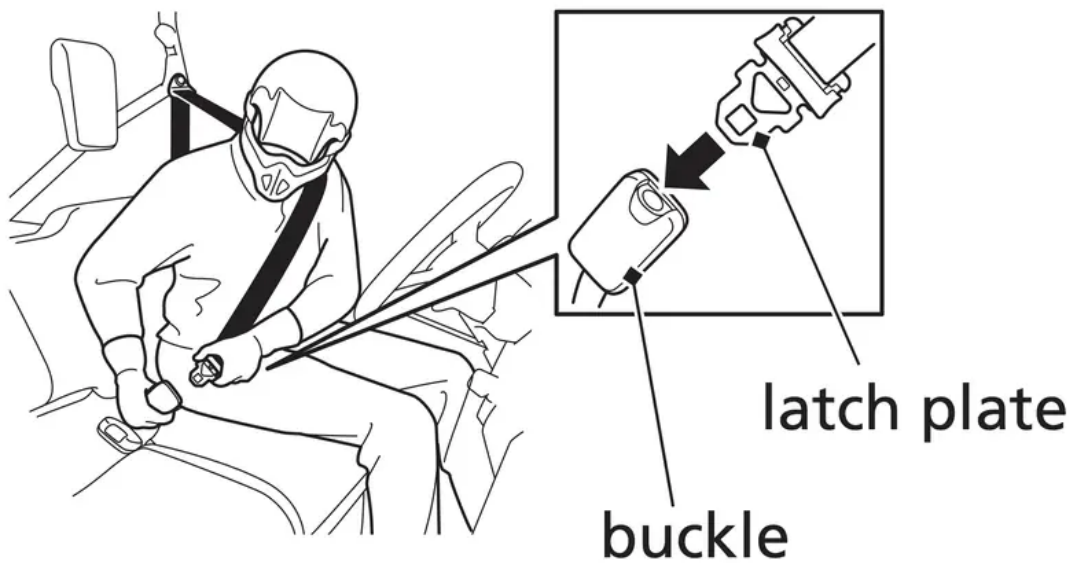

2. Check that the belt is not twisted, because a twisted belt can cause injuries.
3. Position the lap part of the belt as low as possible across your hips, then pull up on the shoulder part of the belt to make sure the lap part is snug. This keeps you connected to the vehicle and lets your strong pelvic bones take the force of a crash.

4. Make sure the shoulder part of the belt goes over your shoulder and rests against your chest.



To unlatch a seat belt, press the red PUSH button on the buckle.

Rear (SXS1000M5P/M5D only)

1. Insert the end latch plate into the outboard buckle first.
2. Insert the middle latch plate into the inboard buckle, then tug on the belt to make sure they are both securely latched.

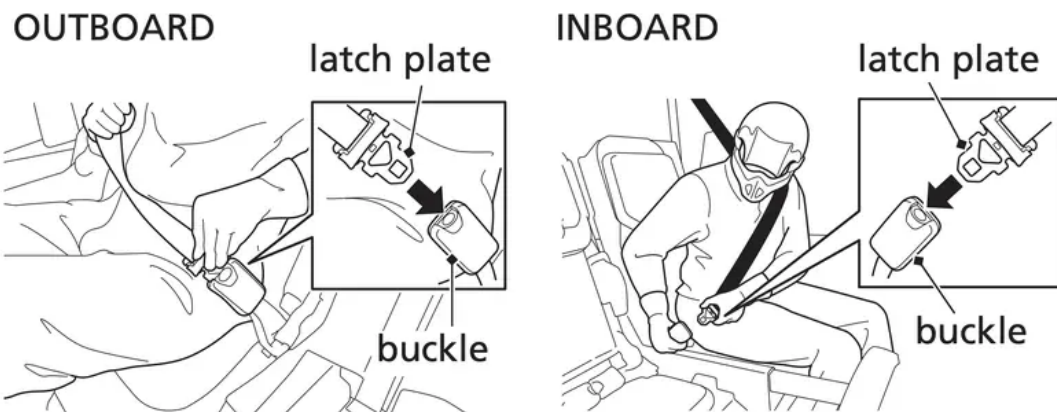

3. Check that the belt is not twisted, because a twisted belt can cause injuries.
4. Position the lap part of the belt as low as possible across your hips, then pull up on the shoulder part of the belt to make sure the lap part is snug. This keeps you connected to the vehicle and lets your strong pelvic bones take the force of a crash.

5. Make sure the shoulder part of the belt goes over your shoulder and rests against your chest.



To unlatch a seat belt, press the red PUSH button on the buckles.

#### Rear Seat Belt Holders (SXS1000M5P/M5D only)

For the rear seat belts, there are seat belt holders to secure the seat belts when using the cargo bed.

How to secure the seat belt:

Hook each of the two latch plates of the rear seat belt to the seat belt holder.

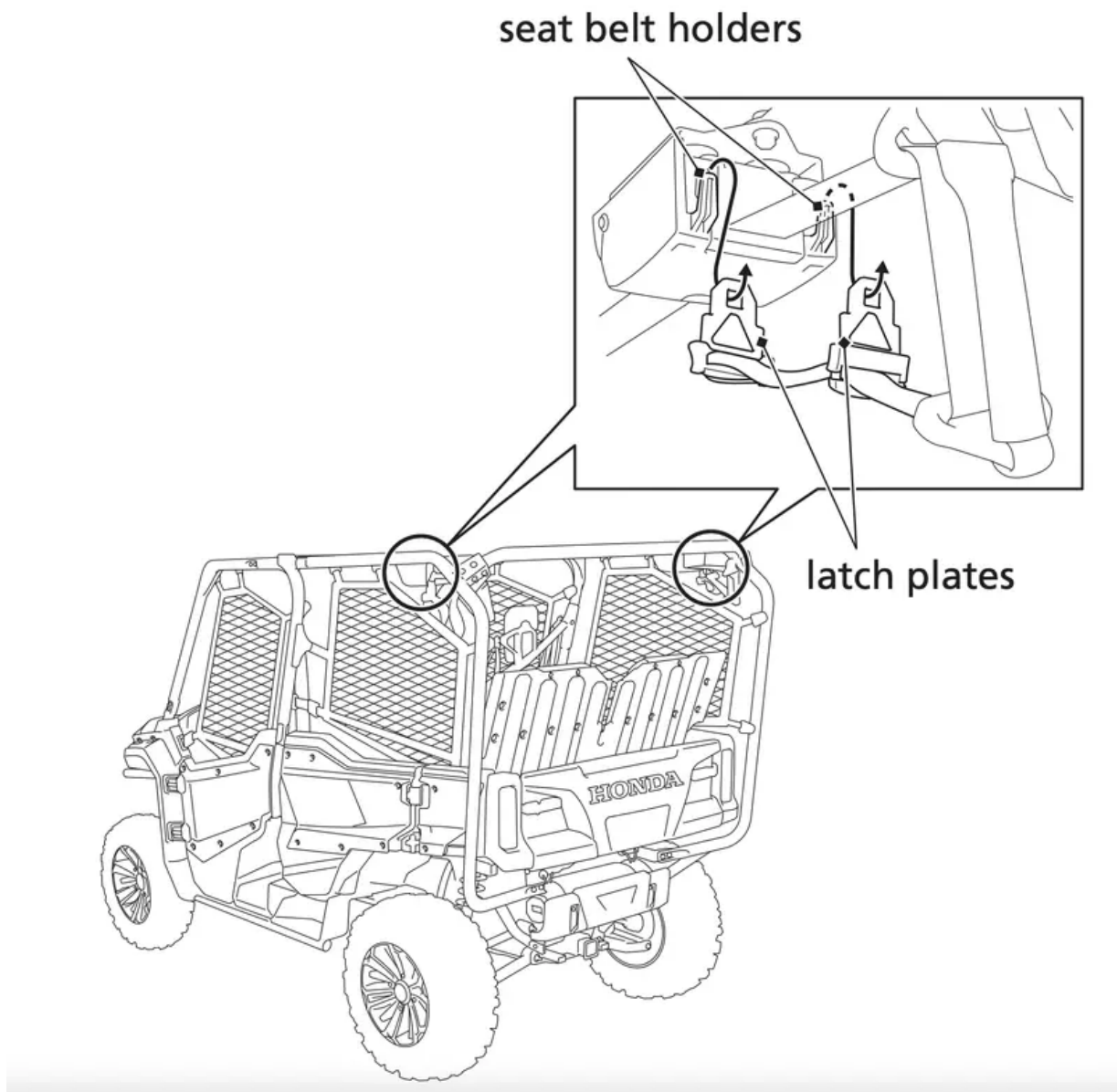

### Seat Belt Locking Mechanism

The seat belts in your Honda SXS are equipped with a belt locking mechanism.

The belt locking mechanism is in the holder of the latch plate. When the seat belt is subjected to intense forces during a crash or rollover, part of the holder locks the belt.

## LOCK POSITION

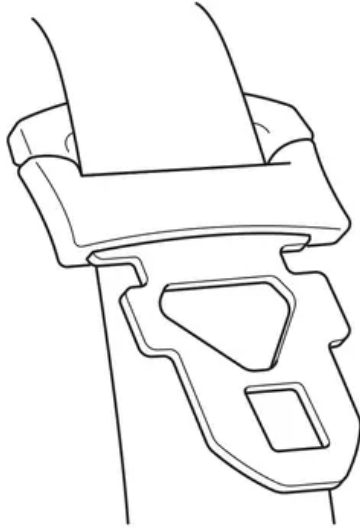

## UNLOCK POSITION (ORDINARY USE)

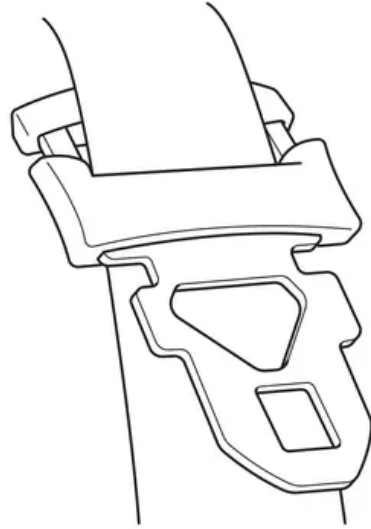

### Unlock

1. To unlatch a seat belt, press the red PUSH button on the buckles.
2. Hold the latch plate and one side of the belt, and pull the other side of the belt. Doing so unlocks part of the holder.

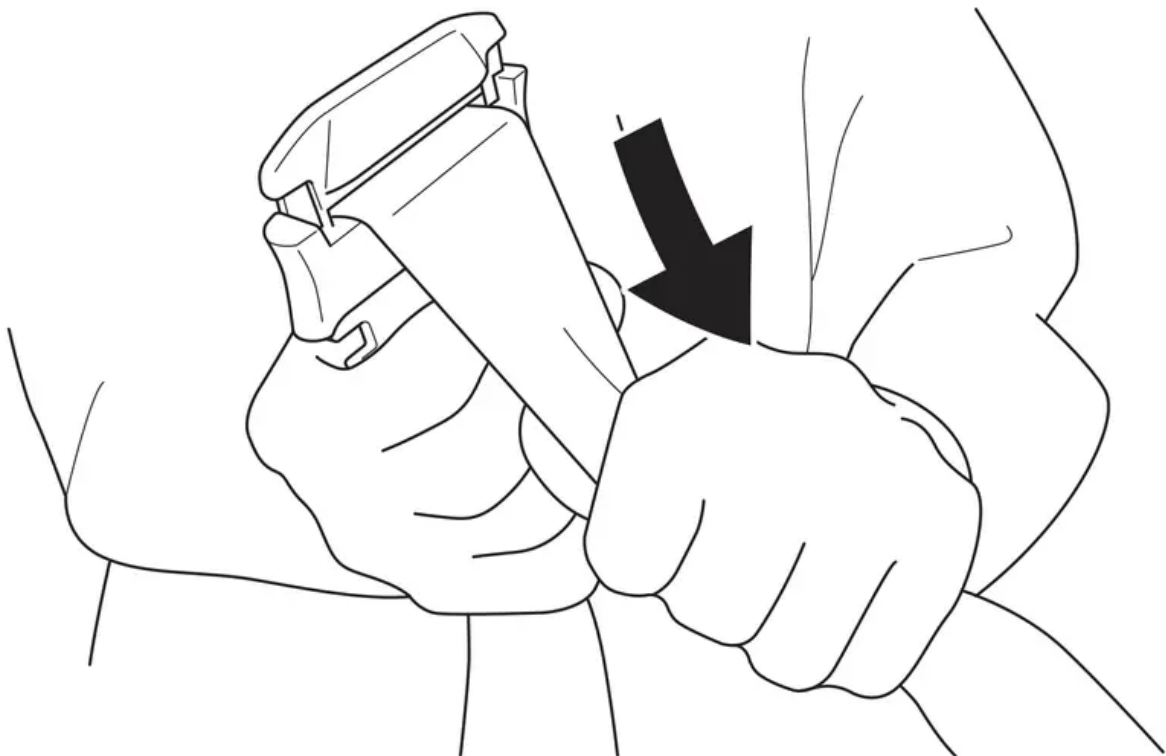

If you have been driving in an extremely muddy or dusty area, be sure to inspect your belt and remove any dirt or debris before letting the belt retract into the retractor. Failure to do so could clog the retractor and make it inoperable.

Each seat belt has an emergency locking retractor. In normal driving conditions, the retractor lets you move freely in your seat while keeping some tension on the belt. During a crash or rollover, the retractor automatically locks the belt to help restrain your body.

Do not put any accessories on a seat belt, as that may reduce the effectiveness of the belt and increase the chance of injury in a crash.

If a seat belt is worn in a crash, the seat belt assembly must be replaced by your dealer. A belt that has been worn during a crash may not provide the same level of protection in a subsequent incident. The dealer should check the retractor and replace it if needed.

## Accessory Power Socket

The accessory power socket is located in the center of the lower dash. The socket is intended for 12-volt DC accessories rated for 120 watts (10 amps) or less. Exceeding the limit can blow the accessory socket fuse (see page 232).

The socket can be used to power such items as a trouble light, spotlight, CB radio, or cell phone, but not a heat-generating accessory, such as a car cigarette lighter.

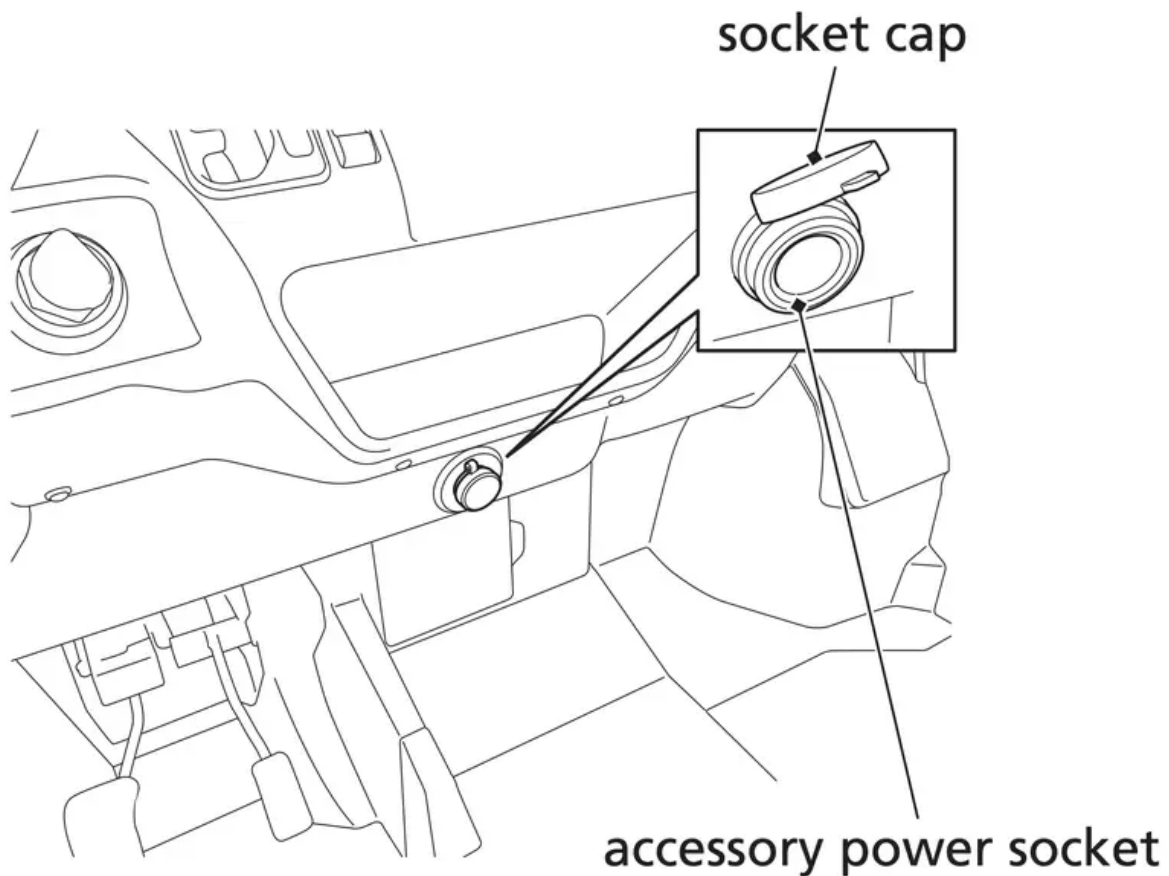

To use the accessory power socket, the engine must be on and idling.

**NOTICE:** Using any heat-generating accessory or improperly rated accessory can damage the socket.

Remember to close the cap when you are finished using an accessory, and keep water or other fluids away from the socket.

## Starting & Stopping the Engine

For safety, we recommend that you start the engine in a wellventilated area. If that is not practical, move the vehicle outdoors as soon as possible. The engine's exhaust contains carbon monoxide, a colorless and odorless gas that can cause illness and even death.

### **WARNING**

- Engine exhaust contains toxic carbon monoxide, a colorless and odorless gas. Breathing it can cause unconsciousness and even kill you.
- If you must start the engine in a poorly ventilated area, move it outdoors immediately.

The starter motor will operate when the shift select lever is in the park (P) or neutral (N) position, or the brake pedal is pressed. You should do the following checks and adjustments before you drive your vehicle.

### Before START:

1. Make sure the doors, side nets, tailgate and front hood are securely closed.
2. Make sure the cargo bed is securely lowered.
3. Check that any items you may be carrying are stored properly or fastened down securely.
4. Fasten your seat belt. Check that any passenger has fastened their seat belt as well.
5. When you start the engine, check the indicators in the instrument panel.

### Starting the engine:

1. Move the shift select lever into the park (P) position.
2. Press on the brake pedal.
3. To start the engine, without touching the accelerator pedal, insert the key and turn the ignition switch to the START (p) position.  
Immediately after the engine starts, let go of the key. The switch returns to the ON (q) position.  
Do not hold the key in the START (p) position for more than 5 seconds at a time.  
If the engine does not start after 5 seconds, turn the key back to the OFF (w) position and wait about 10 seconds before turning it to START (p) again.
4. If the engine does not start within 5 seconds, or starts but stalls right away, repeat step 3 with the accelerator pedal pressed halfway down.

If the engine starts, release pressure on the accelerator pedal so the engine does not race.

5. If the engine fails to start, press the accelerator pedal all the way down, and hold it there while starting to clear flooding. If the engine still does not start, return to step 3.

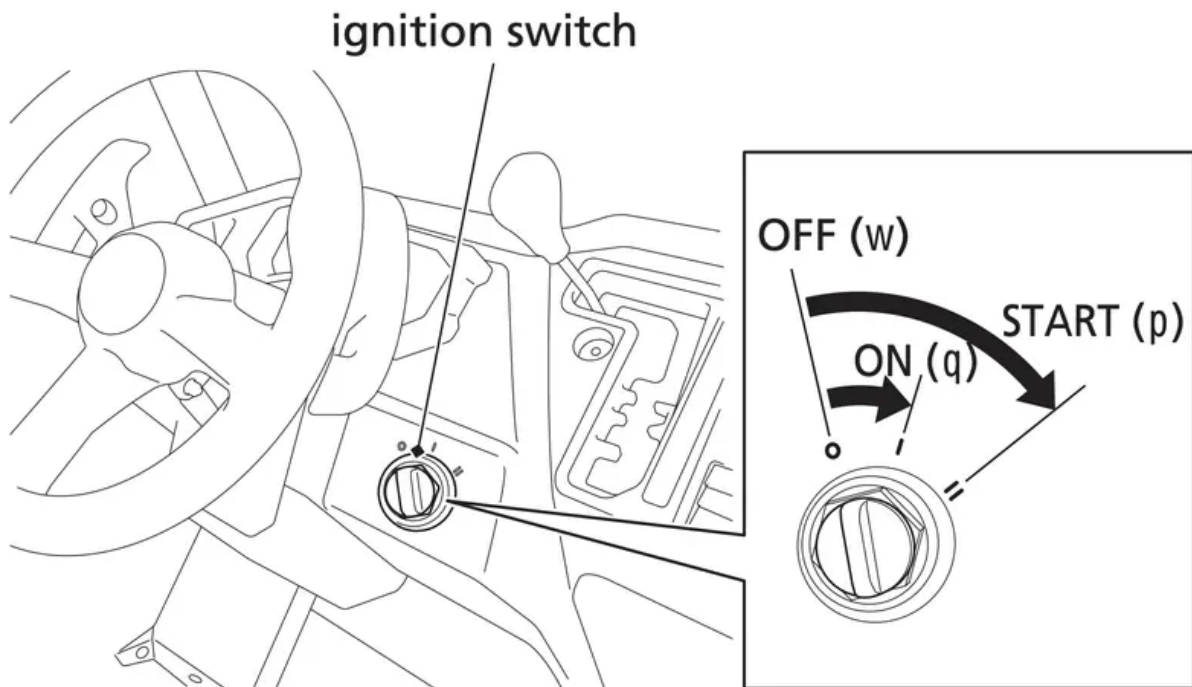

To stop the engine, turn the ignition switch to the OFF (w) position. Remember to shift into the park (P) position and remove the key if you plan to leave the vehicle.

## Is Your Vehicle Ready to Drive?

Before driving your Honda SXS, it's important to inspect the vehicle and correct any problem you find. A pre-drive inspection is a must, not only for safety, but because having a breakdown can be a major inconvenience.

If your vehicle has overturned or been involved in a crash, do not drive it until it has been inspected by your dealer. There may be damage or other problems you cannot see.

### WARNING

- Improperly maintaining this vehicle or failing to correct a problem before driving can cause a crash in which you or someone else can be seriously hurt or killed.
- Always perform a pre-drive inspection and correct any problems before you operate the vehicle.

### Pre-drive Inspection

Check the following items before driving your Honda SXS:

Oil Level	Check the engine and sub-transmission oil levels and add oil, if needed (pages 139, 148). Also check under the vehicle for leaks.
Coolant	Check the coolant level (page 157). If it is low, add a 50/50 mixture of silicate-free coolant and distilled water. Check for leaks.
Fuel Level	Check the fuel gauge (page 24) and add fuel, if needed (page 134). Make sure the fuel fill cap is secure. Also check for the smell of fuel or fumes - if you smell any fuel, turn the ignition switch to OFF (w) immediately, and see your dealer.
Brake Fluid	Check the level (page 182). If it is near MIN, check the brake pads for wear (page 184). If the brake pads are within the specification, check for leaks in the braking system (page 181).
Tires	Check the air pressure of all tires and inflate them to the proper pressure (page 188). Also inspect the tires for damage or excessive wear (page 190). If necessary see your dealer.
Wheels	Make sure the wheel nuts are properly tightened and the wheels are not cracked or deformed (page 195).
Driveshafts	Inspect the driveshafts and boots for damage, tears, or leaks and see your dealer if any are found.
Steering gearbox and boots	Check the steering to make sure it turns smoothly in both directions. Check for any tears in the boots. If any tears are found, see your dealer.
Underbody	Check for and remove any debris stuck in the underbody; take extra care in your inspection if the vehicle was last driven in deep grass, brush, a wetland, or flooded area. Check for any visible dents or cracks. If any dents or cracks are found, see your dealer.
Suspension	Check the condition of all suspension components. Be sure to look for bends or oil leaks in the cushion damper. Check for tears in the boots of the front arm ball joint.



Lights	Make sure the headlights, taillights, and brake lights are working properly.
Controls	Check that all driving controls, including the accelerator pedal, brake pedal, drive mode select lever, shift select lever, and shift paddles are operating smoothly.
Tie-rod ends	The wheels need to be lifted off the ground to correctly check the tie-rod ends, so it cannot be done in the pre-drive inspection. To have the tie-rod ends properly inspected, see your dealer.
Cargo	Be sure items in the cargo bed are within the cargo limit and are properly secured to prevent shifting (pages 81, 82).
Seat Belts	<p>Make sure all seat belts are in good condition and operate properly. The seat belts must move smoothly when pulled out, and retract on their own when released.</p> <p>The latch plates should click securely into the buckles and release when the release buttons are pushed firmly.</p>
Side Nets	Make sure all side nets and their mounting hardware are in good condition and that they latch and tighten securely.
Exhaust System	Make sure no materials or debris are sticking to, or accumulating around, the exhaust system. If any such debris is found, remove it so there's no chance for it to catch on fire. Start the engine and listen for any leaks.

### CAUTION

- Exhaust system and catalyst operate at very high temperatures.
- You can be burned if you touch the exhaust system or catalyst.
- Do not touch the exhaust system or catalyst without letting the system cool down.

**NOTICE:** Exhaust system and catalyst operate at very high temperatures. Accumulated debris and vegetation that contact the exhaust/ catalyst can catch on fire.

Always conduct a pre-ride inspection and remove accumulated debris.

Remember to take care of any problem you find or have your dealer correct it before you drive your Honda SXS.

# Taking Care of the Unexpected

## General Guidelines

Keeping your Honda SXS well-maintained is the best way to reduce the possibility of having a problem while driving. However, problems can arise even with well-maintained machines.

Remember to take along your owner's manual, the tool kit that came with your Honda SXS, and any other items (such as tire repair supplies and additional tools) that might help you solve a problem on your own.

If something goes wrong during a drive, the first thing to do is stop as soon as you safely can. Do not continue driving if you have a flat tire, or you hear an unusual noise, or your Honda SXS just doesn't feel right. If you continue driving, you could cause more damage and endanger your own safety.

After stopping, take time to assess the situation. Carefully inspect your Honda SXS to identify the problem, then consider your options before you decide what to do.

If a problem is relatively minor and you have the tools, supplies, and skills to make a permanent repair, you may be able to fix it on the trail and continue driving.

When a problem is more serious — or you don't have the tools, supplies, experience, or time to deal with it — you need to choose the safest way to get yourself and your Honda SXS back home.

Should you ever have a problem while driving, please follow these guidelines:

- Always put personal safety first.
- Take time to assess the situation and your options before deciding what to do.
- If the problem is relatively minor and you have the tools, supplies, and skills to make a temporary repair, be sure to have permanent repairs made as soon as possible.
- Do not continue driving if you are hurt or your Honda SXS is not in safe driving condition.

Additional recommendations for specific problems follow.

## If Your Engine Quits or Won't Start

Proper operation and maintenance can prevent starting and engine performance problems. In many cases, the cause of the problem may be a simple operational oversight.

If you have a problem starting the engine — or experience poor engine performance — the following information may help you. If you can't correct the problem, see your dealer.

If your SXS won't start, listen as you turn the ignition key to the START (p) position. If you don't hear the starter motor turning, refer to the Starter motor doesn't operate symptom. If you can hear the starter motor working normally, refer to the Starter motor works, but the engine won't start symptom.

**SYMPTOM: Starter motor doesn't operate.**

<b>POSSIBLE CAUSE</b>	<b>WHAT TO DO</b>
transmission not in park (P) or neutral (N) position	Shift into park (P) or neutral (N) position or press on the brake pedal.
blown fuse	Replace with a new fuse of the same rating (page 232).
battery lead loose	Tighten the battery lead.
low battery	Charge the battery (page 201). If charging doesn't help, see your dealer.
faulty starter motor	If all possible causes are negative, the starter motor may be faulty. See your dealer.

**SYMPTOM: Starter motor works, but the engine won't start.**

out of fuel	Fill the fuel tank.
flooded engine	See starting the engine step 5 (page 87).
loose or unconnected spark plug caps	Install the spark plug caps securely. If the engine still won't start, see your dealer.
loose battery cables	Tighten the battery terminal bolts.
weak battery	Charge the battery (page 201). If charging doesn't help, see your dealer.

**SYMPTOM: Engine starts, but runs poorly.**



high coolant temperature	Check the high coolant temperature indicator. Refer to If the High Coolant Temperature Indicator Lights, page 230.
runs erratically, misfires	May damage catalytic converter. See your dealer.
blubbers (rich fuel mixture)	See your dealer.
sooty exhaust (rich fuelmixture)	See your dealer.
detonates or pings under load	If applicable, switch to the recommended octane gasoline (page 134) or change your brand of gasoline. If the problem persists, see your dealer.
after fires (backfires)	May damage catalytic converter. See your dealer.
pre-ignition (runs on after ignition switched OFF)	May damage catalytic converter. See your dealer.
<b>SYMPTOM: Engine starts, but runs poorly or dies when hot.</b>	
poor or inadequate fuel flow due to clogged fuel filter	See your dealer. (ensure clean fuel supply)

## If the Transmission Is Not Functioning Properly

If the gear position indicator is blinking, perform the following:

1. If you are driving your Honda SXS, stop at a safe place.
2. Shift the shift select lever to the park (P) position.
3. Check the pattern displayed on the gear position indicator, and then perform the following.

“P”, “R”, “N”, “H” or “L” is blinking:

You can drive in either AT mode or MT mode. See your dealer as soon as possible.

“1”, “2”, “3”, “4”, “5” or “6” is blinking:

At high-range (H) or low-range (L), you can drive only in the gear position that is blinking. You can also drive in reverse (R).

To avoid damaging the clutch, we recommend that you drive in lowrange (L). The engine brake may not work, so please drive slowly. See your dealer as soon as possible.

"—" is blinking:

Check for SXS failure again. Perform the following procedure.

1. Check that the shift select lever is at the park (P) position.
2. Turn the ignition switch to the OFF (w) position.
3. Turn the ignition switch to the START (p) position and then start the engine.
4. Check the gear position indicator display, and then perform the following.

*The gear position ( "1", "2", "3", "4", "5" or "6" ) is blinking:*

At high-range (H) or low-range (L), you can drive only in the gear position that is blinking. You can also drive in reverse (R).

To avoid damaging the clutch, we recommend that you drive in lowrange (L). The engine brake may not work, so please drive slowly. See your dealer as soon as possible.

## **If the Transmission Is Not Functioning Properly**

*If "-" continues to blink:*

Change the gear position by using the gear change tool, and tighten the emergency valve. Perform the following procedure.

1. Turn the ignition switch to the OFF (w) position, and then stop the engine.
2. Turn the ignition switch to the ON (q) position. Do not turn it to the START (p) position.
3. Take out the gear change tool from the tool kit (page 123).
4. Lift the cargo bed (page 69).
5. Remove the rear mudguard lid (page 129).
6. Set the gear change tool of the spindle which is located on the crankcase.
7. To downshift, turn the gear change tool counterclockwise. To upshift, turn the gear change tool clockwise. When you upshift one position from the lowest downshift position, "E" blinks in the gear position indicator.

If you cannot shift properly, shift the shift select lever to the highrange (H) position, and while pushing the gear change tool in the direction you want to rotate, rock the vehicle back and forth. When the transmission shifts, return the shift select lever to the park (P)

position.

## UNDER CARGO BED

gear change tool

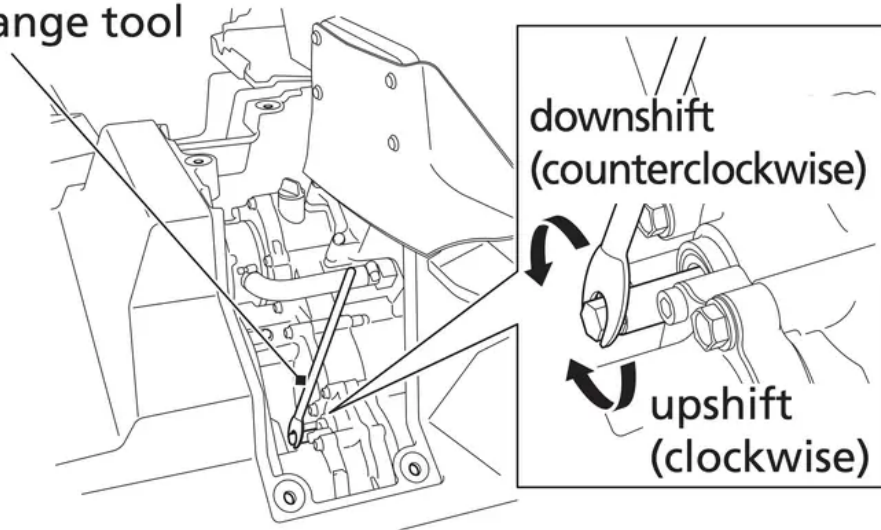

8. Return the gear change tool to the tool kit.
9. Check that "E" is blinking. Next, tighten the emergency valve.  
Proceed to "E" is blinking.

If "-" is not displayed in the gear position indicator and you change the gear position by using the gear change tool, the DCT system will automatically stop. To reactivate the system, turn the ignition switch to the OFF (w) position, and then turn it back to the ON (q) position.

### "E" is blinking:

Tighten the emergency valve. Perform the following procedure.

1. Turn the ignition switch to the OFF (w) position, and then stop the engine.
2. Remove the rear mudguard lid (page 129).

3. Loosen the bolt and release the lock plate, and turn the emergency valve all the way in.

## UNDER CARGO BED

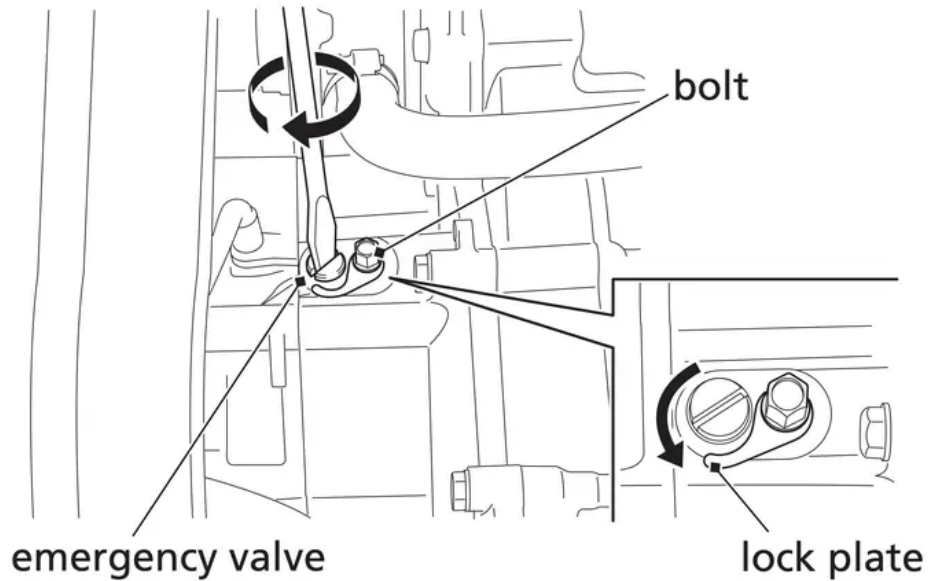

4. Tighten the bolt and the lock plate.
  5. Install the rear mudguard lid.
  6. Turn the ignition switch to the START ( II ) position, and then start the engine.
  7. Check that the gear position ( "1", "2", "3", "4", "5" or "6" ) is blinking.
  8. At high-range (H) or low-range (L), you can drive only in the gear position that is blinking. You can also drive in reverse (R).  
To avoid damaging the clutch, we recommend that you drive in low-range (L). The engine brake may not work, so please drive slowly. See your dealer as soon as possible.
- When in the reverse (R), high-range (H), or low-range (L) position, low oil temperatures will cause the vehicle to move slowly. Shift into the park (P) position and warm up the engine.
  - When restarting the engine, although "E" stops blinking, the gear position ( "1", "2", "3", "4", "5" or "6" )blinks, and the low oil pressure indicator comes on, you can drive the vehicle.

### If You Have a Flat Tire

How you handle a flat tire on the trail depends on how serious the tire damage is, and what tools and supplies you have with you.

If you have a slow leak or a minor puncture, use the plug method to make a temporary repair. (The plug method is applied from the outside of the tire and is the same as that for conventional tubeless tires.)

A plug-type repair kit, available at most auto parts stores or service stations, provides a plug, an installation tool, tire cement, and an instruction sheet. Follow the instructions provided with the repair kit to make a temporary repair.

As soon as possible, have the tire permanently repaired by your dealer.

Any tire that cannot be repaired should be replaced.

Whenever the Honda SXS is to be operated far from service facilities or available transportation, we recommend that you carry a tire pump and a repair kit with the vehicle.

If the leak is more serious, or a temporary repair doesn't hold, the tire must be replaced. The tire will also need to be replaced if it is damaged (page 190). Replacing a tire involves removing and reinstalling the wheel (page 228).

If you are unable to repair a flat tire on the trail, you will need to send for help. We strongly recommend that you do not try to drive with a flat tire. The Honda SXS will be hard to handle, and if the tire comes off the rim, it may lock up the wheel and cause you to crash or overturn.

### Emergency Wheel Removal/Installation

Refer to Safety Precautions on page 111.

#### SXS1000M3/M3P/M5P (Steel wheel model)

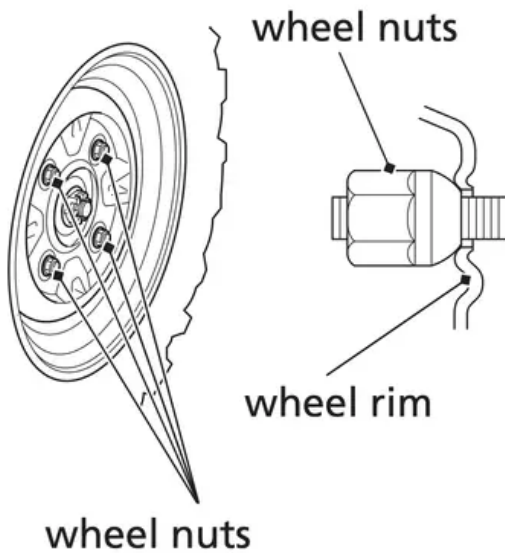

#### SXS1000M5D (Aluminum wheel model)

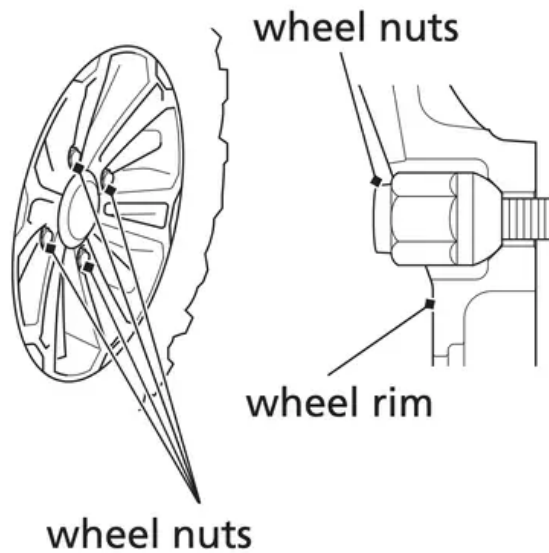

### Removal

1. Park your Honda SXS on a firm, level surface.
2. Loosen — but do not remove — the wheel nuts.
3. Raise the front (or rear) wheels off the ground (page 132).
4. Remove the wheel nuts.

5. Remove the wheel.

Avoid getting grease, oil, or dirt on the disc or pad surfaces when removing and installing each wheel. Any contamination can cause poor brake performance or rapid pad wear after reassembly.

### Installation

1. Position the wheel.
2. Position the wheel nuts so that the tapered sides face the wheel rim.
3. Hand-tighten the wheel nuts on the wheel, then lower the Honda SXS to the ground before tightening the nuts in a crisscross (rather than circular) pattern to the specified torque:  
80 lbf·ft (108 N·m, 11 kgf·m)

If a torque wrench was not used for installation, see your dealer as soon as possible to verify proper assembly. Improper assembly may lead to loss of control and braking capability.

### **If the High Coolant Temperature Indicator Lights**

Normally, the high coolant temperature indicator will only light momentarily when you turn the ignition ON (q). Occasionally, it may flicker at or near idling speed.

High coolant temperature may be caused by restriction of air flow to the radiator (such as mud caked on the radiator), extended idling, an oil leak, a coolant leak, a low oil level, a low coolant level, or extended operation under adverse conditions.

If the all sections of the coolant temperature gauge including segment H and high coolant temperature indicator are on while you're driving, don't ignore it. Pull safely to a stop. Stop the engine as soon as it's safe to do so, and let it cool.

**NOTICE:** Continuing to drive with high coolant temperature or an overheated engine can cause serious engine damage.

- A steaming engine indicates a coolant leak. Shut the engine off and wait until the steaming stops. Look for a leak, but don't touch the engine or radiator system. Let everything cool off first.
- Check for any restriction of air flow to the radiator.
- If there's no obvious problem, leave the engine on so the fan and coolant circulating system can continue working. Monitor the coolant temperature gauge and high coolant temperature indicator. The coolant temperature gauge and indicator may return to normal after a brief stop with no load on the engine.
- Check the radiator fan.

If the fan is not working, turn the engine off. Open the fuse box (page 233) and check the radiator fan fuse. If the fuse is blown, replace it with the proper (same rating) spare fuse. Start the engine. If the all sections of the coolant temperature gauge including segment

H and high coolant temperature indicator are stay on, turn the engine off.

If the radiator fan is working, visually check the coolant level in the reserve tank, located under the front hood. It isn't necessary to touch the radiator system.

- If the reserve tank is low or empty, don't drive without adding coolant (page 157). After adding coolant, turn the engine on and check the coolant temperature gauge and high coolant temperature indicator.

If the indicator doesn't turn off, do not drive. The engine needs repair.

Transport your Honda SXS to a dealer (page 210).

If the temperature drops to normal, check the coolant level. If it has gone down, add more coolant.

- Check for an oil leak.
- Check the oil level. If necessary, add the recommended oil (page 137) to the upper level mark. If you must leave your Honda SXS to get oil, secure it as much as possible.
- Start the engine, and check that the coolant temperature gauge and high coolant temperature indicator are normal.

If the coolant temperature gauge and indicator return to normal, resume driving. If there is a leak, do not drive the SXS until the leak is repaired by your dealer.

If there's a mild coolant leak, you can drive for a while, carefully watching the coolant temperature gauge and indicator. Be prepared to stop and add more coolant or water. If the leak is bad, transport your Honda SXS to your dealer (page 210).

## **If a Fuse Blows**

All of the electrical circuits on your Honda SXS have fuses to protect them from damage caused by excess current flow (short circuit or overload).

If something electrical on your Honda SXS stops working, the first thing you should check for is a blown fuse.

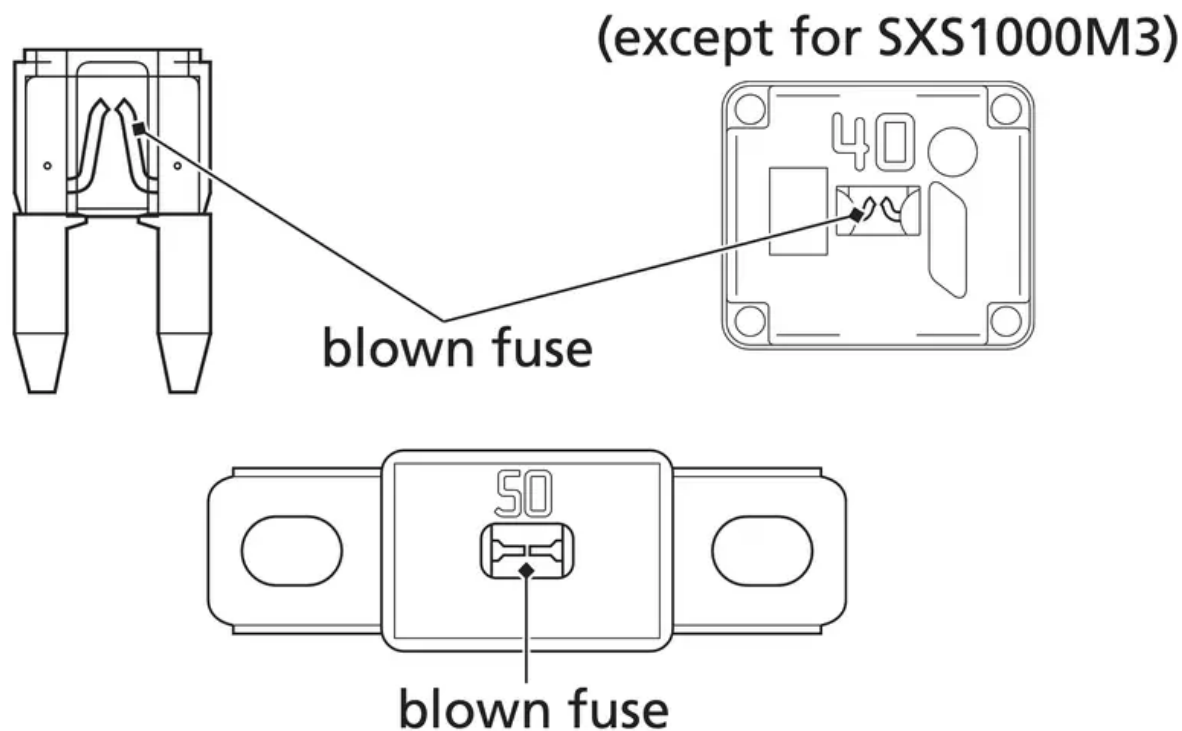

Check all the fuses before looking elsewhere for another possible cause of the problem. Replace any blown fuses and check component operation.

The main fuse and circuit fuses are located in the fuse box under the front hood.

The electric power steering (EPS) fuse is located under the front hood. (except for SXS1000M3)

#### Recommended Fuses

main fuse	50 A
circuit fuses	30 A, 20 A, 15 A × 4, 10 A × 3
electric power steering (EPS) fuse (except for SXS1000M3)	40 A

#### *Main Fuse Access*

1. To prevent an accidental short circuit, turn the ignition switch OFF (w) before checking or replacing the fuses.
2. Remove the front hood (page 125).
3. Remove the fuse box cover.
4. To access the main fuse, remove the bolts, and then pull the main fuse out. If the main fuse is blown, see your dealer for this service.

## UNDER FRONT HOOD

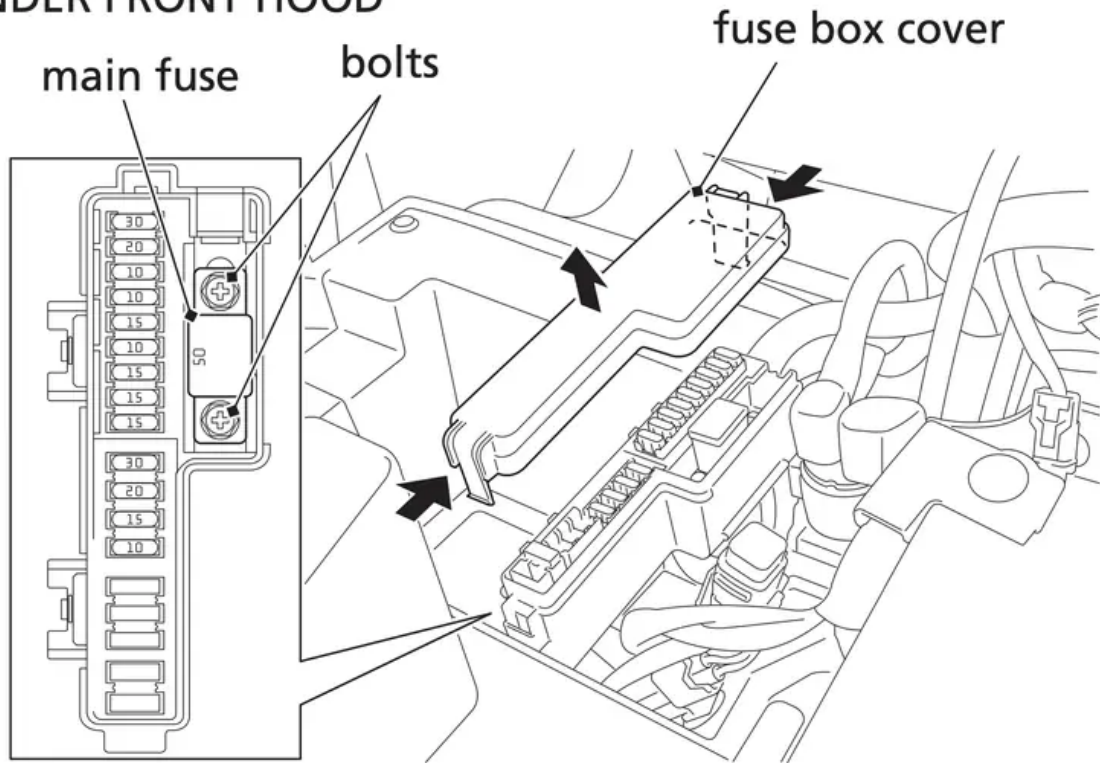

### *Circuit Fuse Access*

1. To check or replace a circuit fuse, pull the fuses out one by one with the fuse puller located behind the fuse box cover. If the fuse is blown, replace it with a spare fuse of the same rating.

If you do not have a replacement fuse with the proper rating for the circuit, install one with a lower rating.

**NOTICE:** Replacing a fuse with one that has a higher rating greatly increases the chance of damage to the electrical system.

2. Install the fuse box cover.
3. Install the front hood.

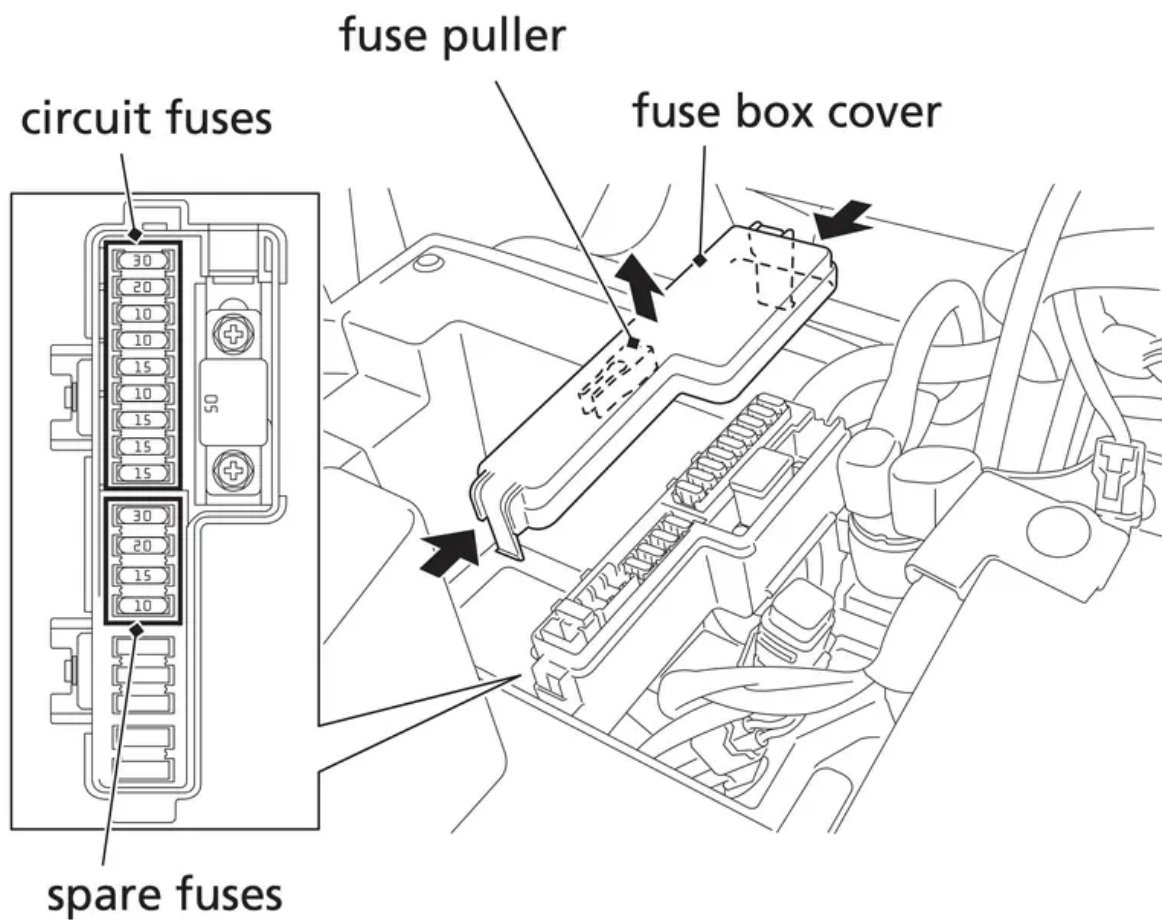

*Electric Power Steering (EPS) Fuse Access (except for SXS1000M3)*

1. Turn the ignition switch to OFF (w) before checking the fuse.
2. Remove the front hood (page 125).
3. To access the EPS fuse, remove the fuse cover.  
If the EPS fuse is blown, see your dealer for this service.
4. Install the fuse cover.
5. Install the front hood.

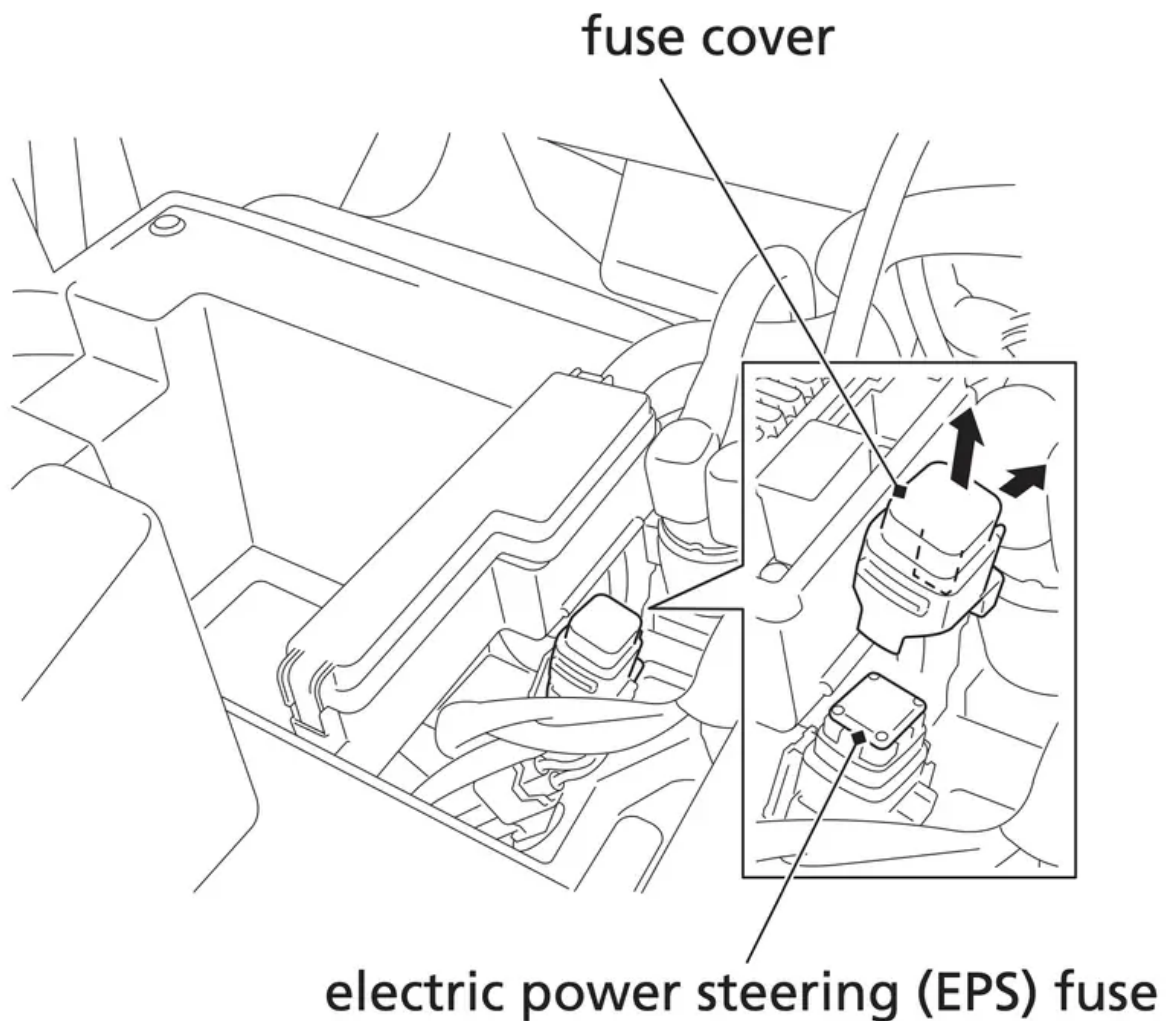

If you do not have a spare fuse and you cannot drive the Honda SXS without fixing the problem, take a fuse of the same rating or a lower rating from one of the other circuits that you can do without temporarily.

If you replace a blown fuse with a spare fuse that has a lower rating, replace the fuse with the correct rating as soon as you can. Also remember to replace any spare fuses that were installed.

If the replacement fuse of the same rating burns out in a short time, there is probably a serious electrical problem on your Honda SXS. Leave the blown fuse in that circuit and have your Honda SXS checked by your dealer.

### **If You Crash**

Personal safety is your first priority after a crash. If you or anyone else has been injured, take time to assess the severity of the injuries and whether it is safe to continue driving. If you cannot drive safely, send someone for help. Do not drive if you will risk further injury.

If you decide that you are capable of driving your SXS safely, first evaluate the condition of your SXS. If the engine is still running, turn it off and look it over carefully; inspect it for fluid leaks, check the tightness of critical nuts and bolts securing such parts as the steering wheel, control levers, brakes, and wheels.

If there is minor damage, or you are unsure about possible damage but decide to try driving the Honda SXS back to your base, drive slowly and cautiously.

Sometimes, crash damage is hidden or not immediately apparent. When you get home, thoroughly check your Honda SXS and correct any problems you find. Also, be sure to have your dealer check the frame suspension, seat belts, and occupant protective structure after any serious crash.

### **If You Lose Your Key**

Be sure to record your key number. Store the spare key and recorded key number in a safe location. You'll need this number to have a duplicate key made.

If you lose your key and aren't carrying a duplicate, either get your spare or have one made. If you don't know your key number, call the dealer where you purchased your Honda SXS. They may have it listed in their records. If they don't, transport your Honda SXS to them or the nearest dealer. The dealer will probably have to remove the ignition switch assembly to find the key number so they can make a key for you.

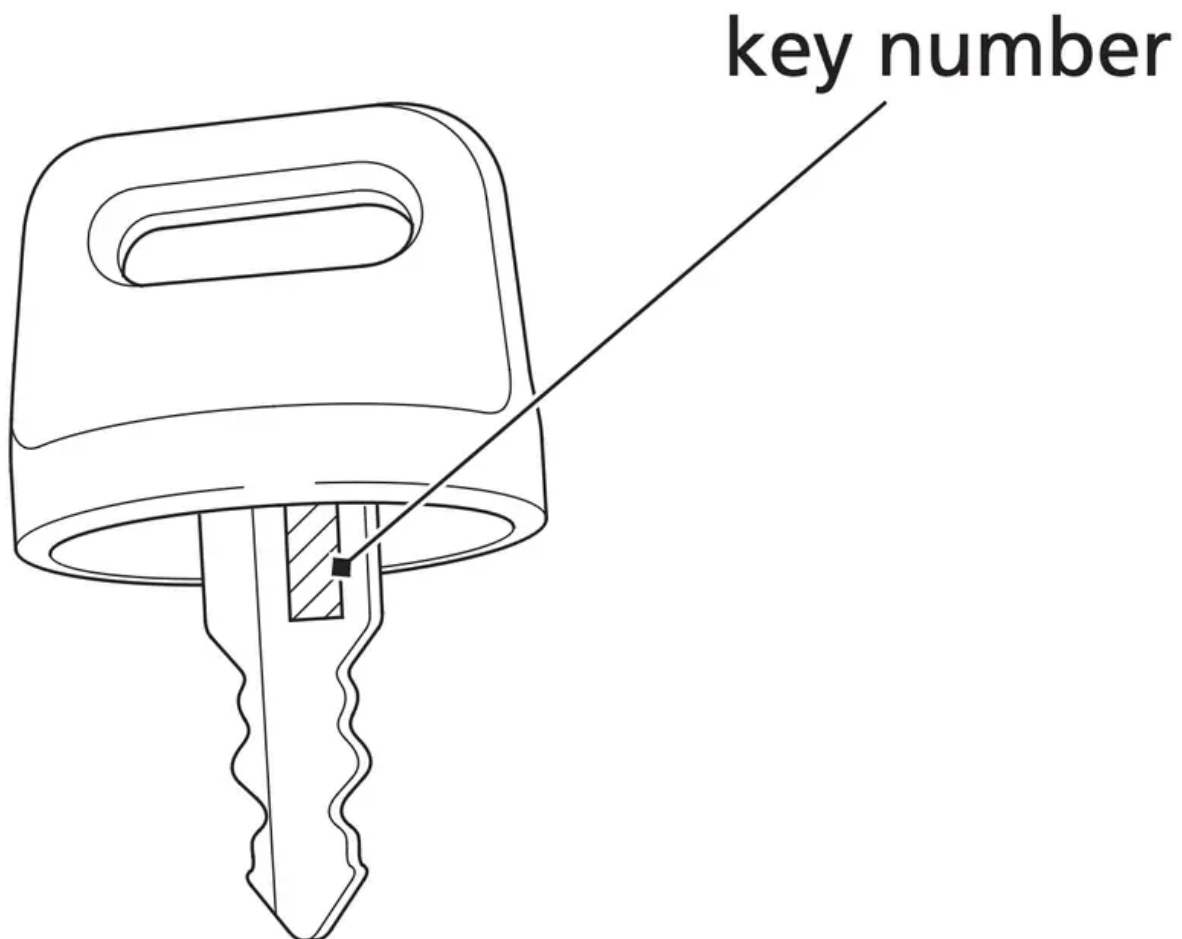

## If the Battery Is Low

If the battery is low, the starter motor doesn't operate or works poorly, and you can't start the engine.

Jump starting your Honda SXS should be avoided.

Instead, the battery should be removed and recharged (page 201). If you can't charge the battery or it appears unable to hold a charge, contact your dealer.

### WARNING

- The battery gives off explosive hydrogen gas during normal operation. A spark or flame can cause the battery to explode with enough force to kill or seriously hurt you.
- Wear protective clothing and a face shield, or have a skilled mechanic do the battery maintenance.

**WARNING:** Battery posts, terminals and related accessories contain lead and lead compounds. Wash your hands after handling.

However, when there is no option other than jump starting, follow the instructions given below.

**NOTICE:** If a battery sits in extreme cold, the electrolyte inside can freeze.

Attempting to jump start with a frozen battery can cause it to rupture.

Use a battery that is the same as the one in the vehicle or an equivalent.

1. To prevent an accidental short circuit, turn the ignition switch OFF (w).
  2. Remove the front hood (page 125).
  3. Using a fully charged 12-volt battery, connect the positive (+) side of the jumper cable to the charged battery, and connect the positive (+) side on the other end of the jumper cable to the positive (+) terminal of vehicle battery.
  4. Connect the negative (-) side of the jumper cable to the charged battery, and connect the negative (-) side on the other end of the jumper cable to the front final gear case bracket.
  5. After starting the engine, remove the negative (-) sides of the jumper cable from the vehicle and the battery. Then remove the positive (+) sides of the jumper cable from the vehicle battery and the charged battery.
  6. Close the rubber dust cover and install the front seat.
- Do not let the positive (+) side of the jumper cable touch on the negative (-) terminal.
  - If the jumper cable is connected to the battery with the polarity reversed, the battery can explode or the electrical system will be seriously damaged.

## UNDER FRONT HOOD LEFT SIDE

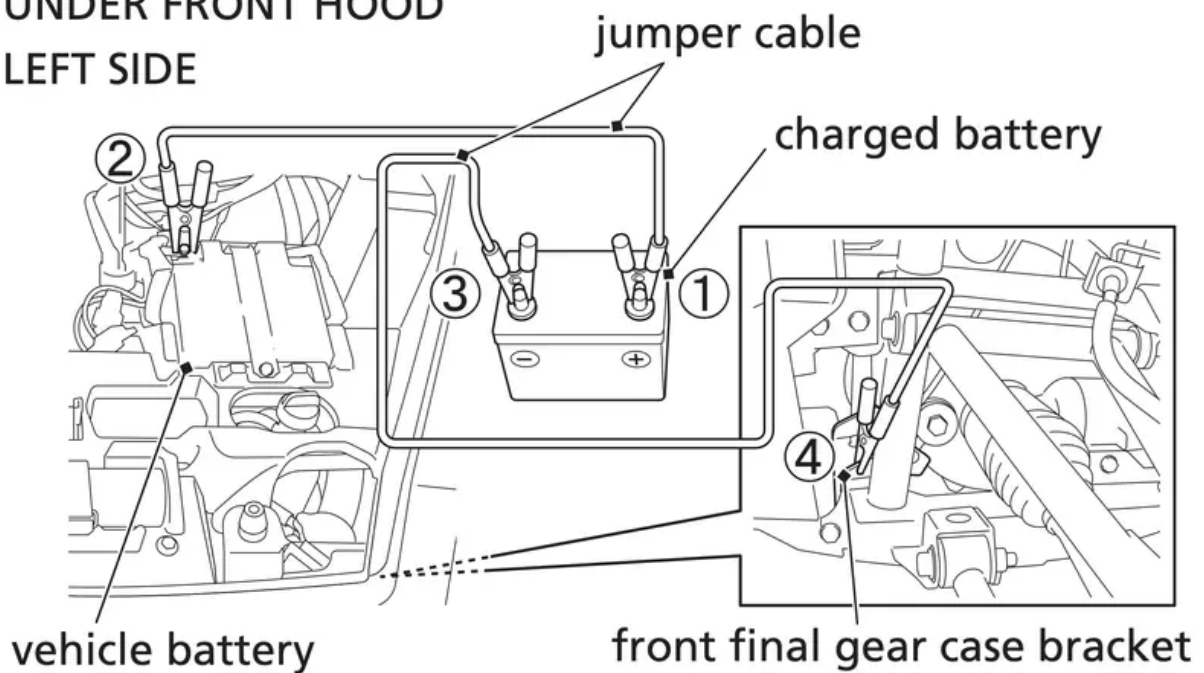

### If a Component Fails

The brake lines, control cables, and other components can be damaged as you drive in dense brush or over rocky terrain. Making a trailside repair depends on how serious the damage is and what tools and supplies you have with you.

- If any component in the brake system is damaged, you may have reduced or limited stopping power. If you decide to continue driving back to your base, do so cautiously and at a very low speed.
- If you damage the accelerator cable or other critical component, your Honda SXS may be unsafe to drive. Carefully assess the damage and make any repairs that you can. But if there is any doubt, it's best to be conservative and safe.

### If Your Honda SXS Becomes Immersed in Water

If your Honda SXS becomes immersed in water (water level is above the floorboard), inspect the vehicle to avoid severe engine damage by following these steps:

1. Move your Honda SXS to dry land or at the very least, to a water level below 10 inches (25 cm).

2. Check the sub air cleaner condition.

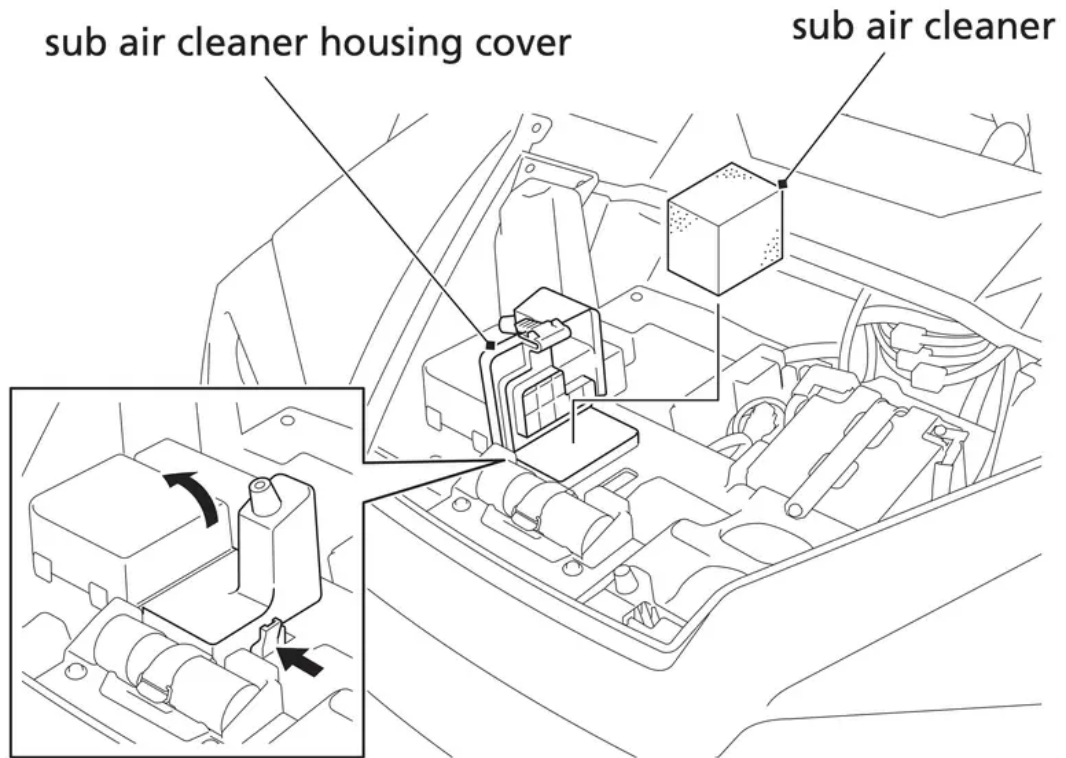

If the sub air cleaner is wet, water may have entered the air intake system. Do not start engine.

If the sub air cleaner is dry, the engine can be restarted.

3. Take your Honda SXS to your dealer for service as soon as possible, even if you succeeded in starting the engine.

### **Warning**

This content is compiled from multiple sources and is provided for reference purposes only. It may not be complete or fully applicable to all situations. If you are unable to resolve your issue, please contact the product manufacturer or an authorized service provider for official support.