

Midea - English - Portable PH

Rated voltage: 115V

Frequency: 60Hz

Warning: Before using this product, please read this manual carefully and keep it for future reference. The design and specifications are subject to change without prior notice for product improvement. Consult with your dealer or the manufacturer for details.

Models: MAP05R1WT and MAP08R1CWT .

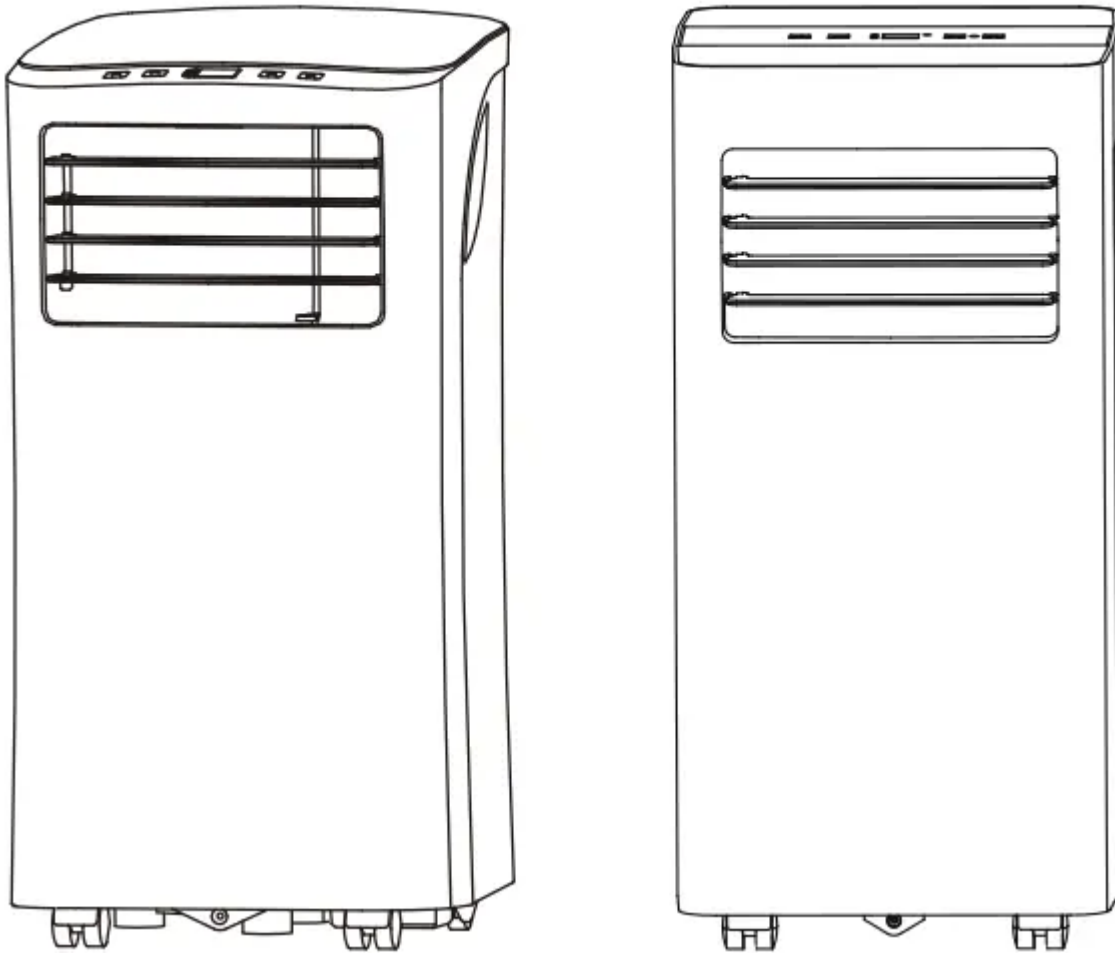

Safety Precautions

To prevent injury to the user or other people and property damage, the instructions shown here must be followed. Incorrect operation due to ignoring of instructions may cause harm or damage. The level of risk is shown by the following indications.

Warning - CAUTION:

- + Plug in power cord plug properly. Otherwise, it may cause electric shock or fire due to excess heat generation.
- + Do not modify power cord length or share the outlet with other appliances as it may cause

electric shock or fire due to overheating.

+ Unplug the unit if you notice unusual sounds or smells, or smoke comes from it. A damaged product may cause fire and electric shock.

+ Keep firearms away from the unit.

+ Ventilate room before operating the air conditioner if there is a gas leakage from another appliance.

+ Do not operate or stop the unit by inserting or pulling out the power cord plug.

+ Do not operate with wet hands or in very humid environments. It may cause electric shock.

+ Do not allow water to come into contact with any electric parts. It may cause failure or electric shock.

+ Do not use the socket if it is loose or damaged. It may cause fire and electric shock.

+ Do not place the power cord close to heating appliances. It may cause fire and electric shock

+ Do not disassemble or modify unit. It may cause failure and electric shock.

+ Do not damage or use an alternate power cord.

+ It may cause fire and electric shock.

+ If the power cord is damaged, it must be replaced by the manufacturer or an authorized service center or a similarly qualified person in order to avoid a hazard.

+ Do not direct airflow straight into persons to avoid possible health hazard.

+ Do not open the unit during operation.

+ It may cause electric shock.

+ Do not use the power cord near flammable gas or combustibles, such as gasoline, benzene, thinner, etc.

+ It may cause an explosion or fire.

+ Avoid fire hazard or electric shock. Do not use an extension cord or an adaptor plug. Do not remove any prongs from the power cord.

+ Be sure the air conditioner is properly grounded. To minimize shock and fire hazards, proper grounding is important. The power cord is equipped with a three-prong grounding plug for protection against shock hazards.

+ Your air conditioner must be used in a properly grounded wall receptacle. If the wall receptacle you intend to use is not adequately grounded or protected by a time delay fuse or circuit breaker, have a qualified electrician install the proper receptacle. Ensure the receptacle is accessible after the unit installation.

+ Be sure the electrical service is adequate for the model you have chosen. This information can be found on the serial plate, which is located on the side of the cabinet and behind the grille.

+ Do not drink water drained from the air conditioner.

When the air filter is to be removed, do not touch the metal parts of the unit.

It may cause injury.

When the unit needs cleaning, switch off, and turn off the circuit breaker.

Do not clean unit when power is on as it may cause fire, electric shock or injury.

Do not place obstacles around air inlets or inside of air outlet.

It may cause failure or accident.

Clean with a soft cloth only. Do not use strong detergents that contain wax or thinners as it may damage the product.

Use caution when unpacking and installing. Sharp edges could cause injury.

Do not clean the air conditioner with water.

Water may enter the unit and degrade the insulation which could lead to electric shock.

Do not put a pet or house plant where it will be exposed to direct air flow.

This could injure the pet or harm the plant.

Hold the plug by the head of the power plug when taking it out.

Otherwise, it may cause electric shock and damage.

Ensure that the installation is properly secured to prevent the product from potentially falling.

Do not place heavy objects on the power cord and ensure that the cord is not compressed.

Otherwise, there is danger of fire or electric shock.

If water is spilled on the unit, turn off the unit and switch off the circuit breaker.

Isolate supply by taking the power-plug out and contact a qualified service technician.

Do not use near gas stove or other gas burning appliances, as air flow may affect gas combustion.

Do not use for any purpose other than room comfort.

Do not use this air conditioner to preserve precision devices, food, pets, plants. and art objects. It may cause deterioration.

Turn off the main power switch if the unit is not to be used for an extended time.

Always insert the filters securely. Clean filter once every two weeks.

Operation without filters may cause failure.

Operation of Current Device

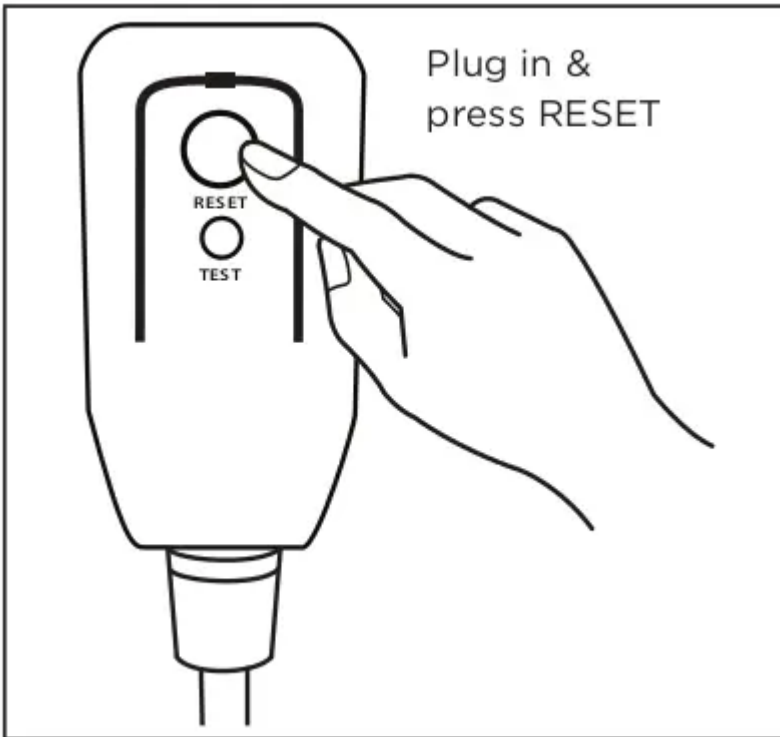

The power supply cord contains a measurement current device that senses damage to the power cord. Test your power supply cord as follows:

1. Plug in the air conditioner.
2. The power supply cord will have TWO buttons on the plug head. Press the TEST button. You will notice a click as the RESET button pops out.
3. Press the RESET Button. You will notice a click as the button engages.
4. The power supply cord is now supplying electricity to the unit. (On some products this is also indicated by a light on the plug head.)

NOTICE:

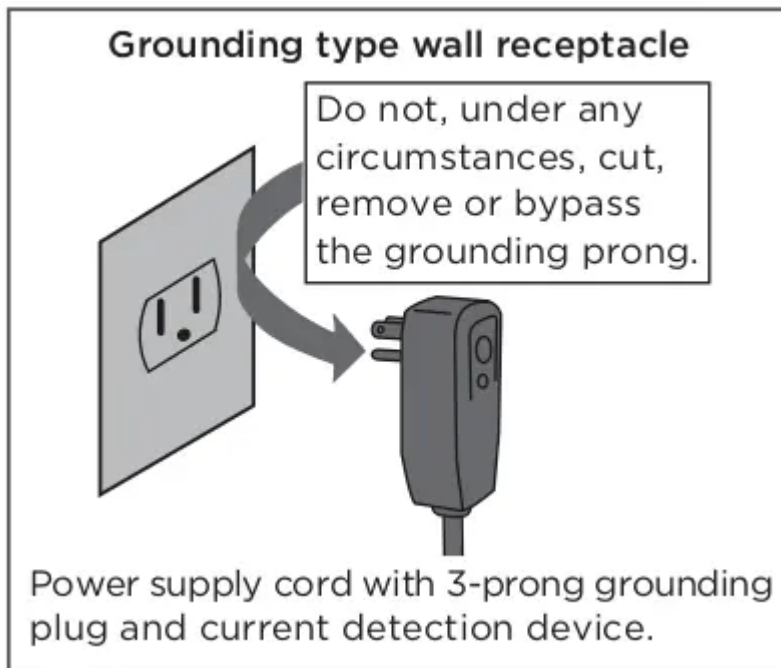

The power supply cord with this air conditioner contains a current detection device designed to reduce the risk of fire.

In the event that the power supply cord is damaged, it can not be repaired. It must be replaced with a cord from the manufacturer.

Do not use this device to turn the unit on or off.

Always make sure the RESET button is pushed in for correct operation.

The power supply must be replaced if it fails to reset when either the TEST button is pushed, or it can not be reset. Please contact Customer Service.

EXPLANATION OF SYMBOLS DISPLAYED ON THE UNIT

	WARNING	This symbol shows that this appliance used a flammable refrigerant. If the refrigerant is leaked and exposed to an external ignition source, there is a risk of fire.
	CAUTION	This symbol shows that the operation manual should be read carefully.
	CAUTION	This symbol shows that a service personnel should be handling this equipment with reference to the installation manual.
	CAUTION	This symbol shows that information is available such as the operating manual or installation manual.

WARNING (for using R32 refrigerant only)

- Do not try to accelerate the defrosting process or methods of cleaning that are not recommended by the manufacturer.
- The appliance shall be stored in a room without a continuously operating ignition source (for example, open flames or an operating gas appliance) or an ignition source (for

example, an operating electric heater) close to the appliance. The appliance shall also be stored in a room without ignition sources.

- Do not pierce or burn.
- Be aware that the refrigerants may not contain an odor.
- Keep ventilation openings clear of obstruction.
- Unit is only to be serviced by a Midea authorized servicer, please call Customer Service at 1-866-646-4332 for support.
- Flammable refrigerant R32 is used within air conditioner. Please follow the instructions carefully to handle, install, clean, and service the air conditioner to avoid damage or hazard. Do not dispose of air conditioner in regular trash.
- Contact qualified agency for proper disposal.
- No open fire or devices that generate spark/arcing shall be around the air conditioner to avoid causing ignition of the flammable refrigerant used. Please follow the instructions carefully to store or maintain the air conditioner to prevent mechanical damage from occurring.

Unit Specifications and Features

Preparation

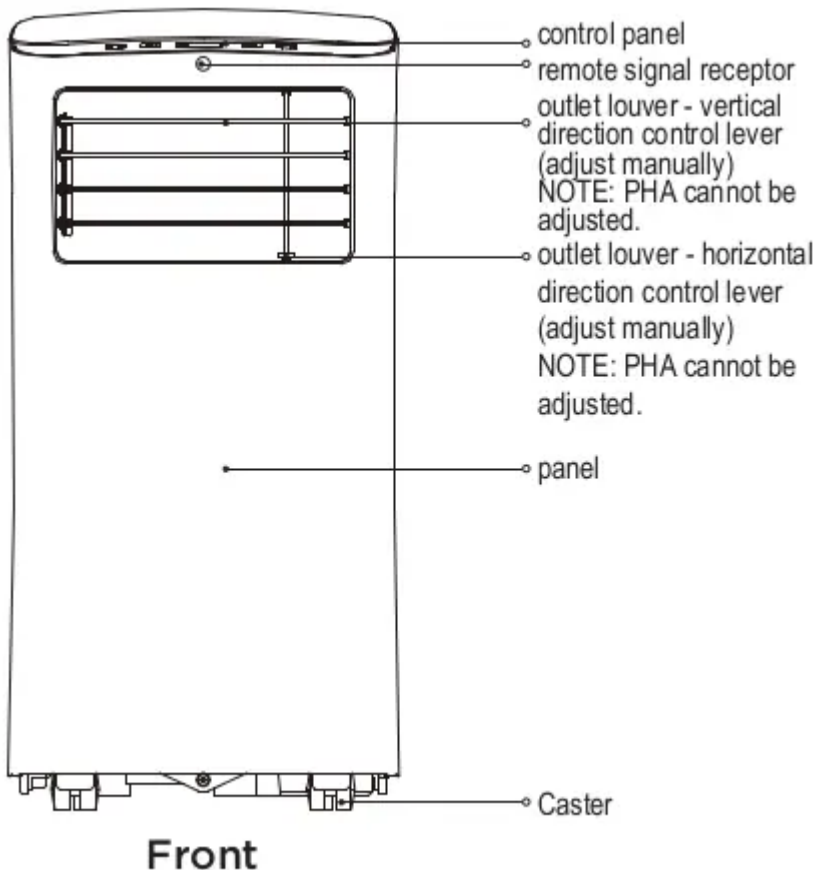

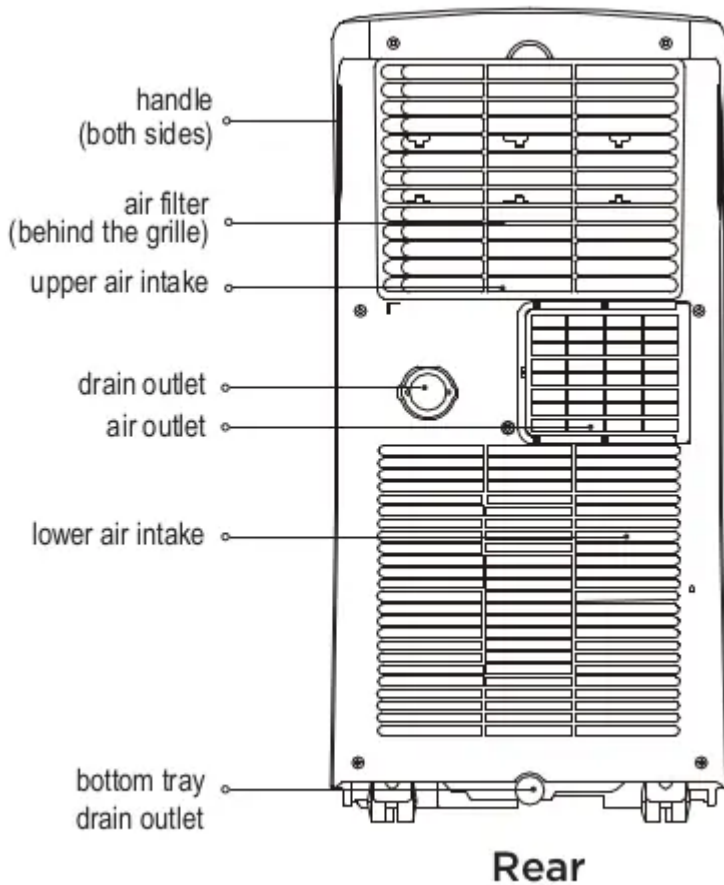

Design and Compliance Notes

Design Notice: In order to ensure the optimal performance of our products, the design specifications of the unit and remote control are subject to change without prior notice.

Energy Rating Information: This product is tested in accordance to the DOE SACC capacity energy rating test.

Unit Temperature Range:

Mode	Temperature Range
Cool	17°C - 35°C (62°F - 95°F)
Dry	13°C - 35°C (55°F - 95°F)

EXHAUST HOSE INSTALLATION:

The exhaust hose and adaptor must be installed or removed in accordance with the usage mode.

For COOL or AUTO mode, exhaust hose must be installed.

For FAN or DEHUMIDIFY exhaust hose must be removed.



Operating Instructions

Control Panel Features

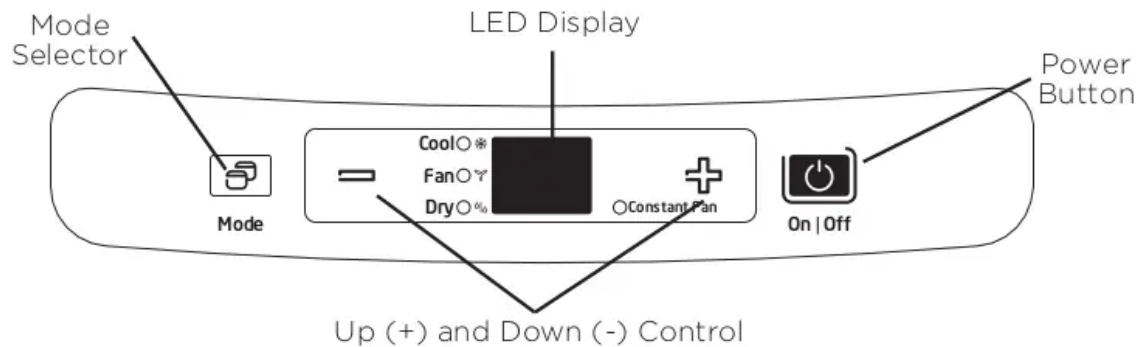

Mode Button

Selects the desired operating mode. Each time you press the button, a mode is selected in a sequence that goes from COOL, FAN and DRY. The mode light illuminates and indicates the selected mode.

NOTE

On above modes, the unit operates the auto fan speed automatically. You can set fan speed only by the remote controller on COOL and FAN modes.

Up (+) and Down (-) Buttons

Used to adjust (increasing/decreasing) temperature settings in 1°C/1°F increments in a range of 17°C/62°F to 30°C/86°F.

NOTE

The control is capable of displaying temperature in degrees Fahrenheit or degrees Celsius. To convert from one to the other, press and hold the Up and Down buttons at the same time for 3 seconds.

Power Button

Power switch on/off.

LED display

Shows the set temperature while on cool mode. While on DRY and FAN modes, it shows the room temperature.

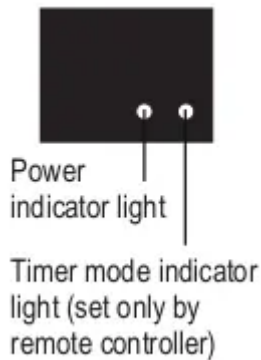

Shows Error codes:

- E1 - Room temperature sensor error.
- E2 - Evaporator temperature sensor error.
- E3 - Condenser temperature sensor error.
- E4- Display panel communication error.

Shows protection code:

P1 - Bottom tray is full - Connect the drain hose and drain the collected water away. If protection code repeats, call for service.

NOTE

When one of the above malfunctions occurs, turn off the unit and check for any obstructions. Restart the Unit. If the malfunction persists, turn off the unit and unplug the power cord. Contact the manufacturer or its service agents or a similar qualified person for service.

COOL operation

- Press the “MODE” button until the “COOL” indicator light comes on.
- Press the UP and DOWN buttons “+” or “-” to select your desired room temperature. The temperature can be set within a range of 17°C-30°C/62°F-86°F.
- The fan speed is automatically set to auto. Use the remote to adjust the fan speed if desired.

DRY operation

- Press the “MODE” button until the “DRY” indicator light comes on.
- While in this mode, you cannot select a fan speed or adjust the temperature. The fan motor operates at LOW speed.
- Keep windows and doors closed for the best dehumidifying effect.

FAN operation

- Press the “MODE” button until the "FAN" indicator light comes on.

- Press the “FAN SPEED” button to choose the fan speed. The temperature cannot be adjusted.

Other Features

SLEEP/ECO operation

This feature can be activated from the remote control ONLY. To activate SLEEP feature, the set temperature will increase by 1°C/2°F in 30 minutes. The set temperature will then increase by another 1°C/2°F after an additional 30 minutes.

This new temperature will be maintained for 7 hours before it returns to the originally selected temperature. This ends the Sleep mode and the unit will continue to operate as originally programmed.

NOTE: This feature is unavailable in FAN or DRY mode.

COMFORTSENSE

Feature (only for some models)

NOTE

This feature can be activated from the remote control ONLY. The remote control serves as a remote thermostat allowing for the precise temperature control at its location.

To activate the Temp Sensing feature, point the remote control towards the unit and press the Temp Sensing button. The remote display is actual temperature at its location. The remote control will send this signal to the air conditioner every 3 minutes until the ComfortSense button is pressed again.

If the unit does not receive the Temp Sensing signal during any 7 minutes interval. the unit will exit the Temp Sensing mode.

Constant Fan button

Feature (optional) in cooling or Dry mode. press the button for 3 seconds to turn on or off the constant fan function. When the function is turned on, the constant fan light will illuminate, identifying the fan continuous run for cooling. When the function is turned off, the constant fan light will go out. identifying the fan cycle run with compressor stop.

AUTO-RESTART

If the unit shuts off unexpectedly due to a power outage, it will restart with the previous set function when the power resumes.

WAIT 3 MINUTES BEFORE RESUMING OPERATION

After the unit has stopped, it cannot be restarted until 3 minutes time has elapsed. This is to protect the unit. Operation will automatically resume after 3 minutes.

AIRFLOW DIRECTION ADJUSTMENT

Adjust the air flow direction manually:

- The louver can be set to the desired position manually.
- Do not place any heavy objects or other loads on the louver, doing so will cause damage to the unit.
- Keep the louver fully opened during operation.

Water drainage

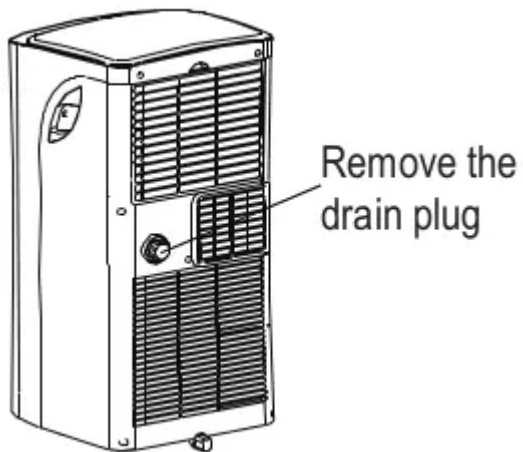

During DRY mode, remove the upper drain plug from the back of the unit and install the drain connector (5/8" universal female adapter) with a 3/4" hose (not included). For models without the drain connector, attach the drain hose to the connector. Place the end of the hose in the drain area you're using.

NOTE

Make sure the hose is secure so there are no leaks. Direct the hose toward the drain, making sure that there are no kinks that will restrict water flow. Place the end of the hose into the drain making sure the end of the hose is directed downward. When the continuous drain hose is not used, ensure that the corresponding drain plug and knob are securely installed to prevent leaks.

Continuous
drain hose

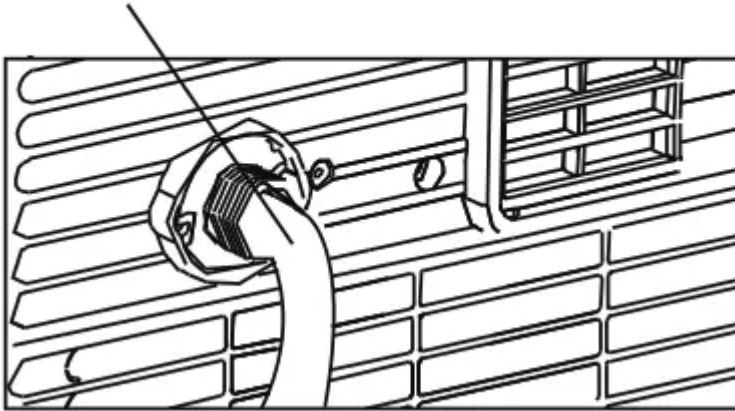

When the water level of the bottom tray reaches a predetermined level, the unit beeps 8 times.

The digital display shows “P1.” At this time the air conditioning/dehumidification process will immediately stop. However, the fan motor will continue to operate (this is normal). Carefully move the unit to a drain location, remove the bottom drain plug and let the water drain away. Reinstall the bottom drain plug and restart the machine until the “P1” symbol disappears. If the error repeats, call for service.

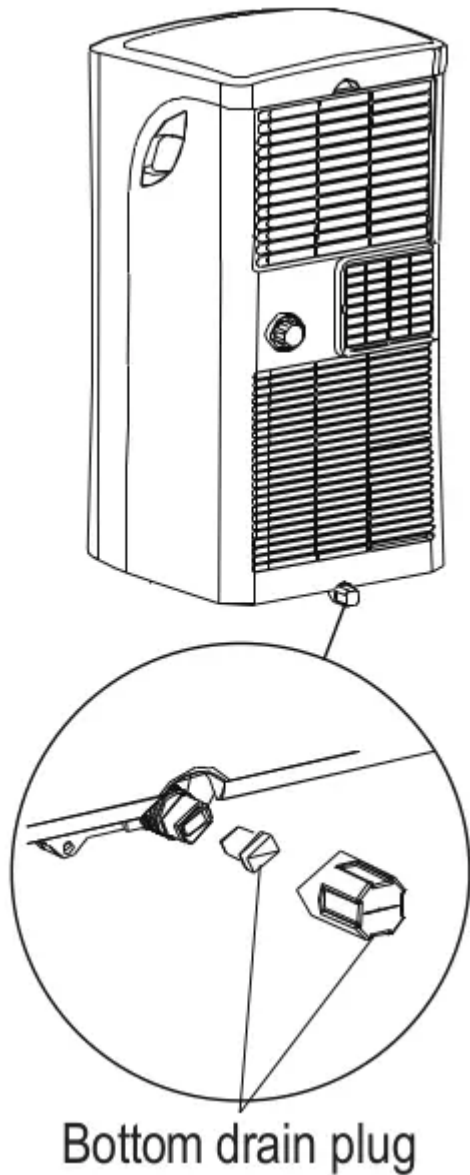

NOTE: Be sure to reinstall the bottom drain plug firmly to prevent leakage before using the unit.

Installation Instructions

Choosing the Right Location

Your installation location should meet the following requirements:

- The unit must be near a window to install the exhaust hose and window kit into.
- Make sure that you install your unit on an even surface to minimize noise and vibration.
- The unit must be installed near a grounded plug, and the Collection Tray Drain (found on the back of the unit) must be accessible.
- The unit should be located at least 12" (30cm) from the nearest wall to ensure proper air conditioning. Obstacles should be at least 19.7" (50cm) away from the outlet louver.

- DO NOT cover the Intakes, Outlets or Remote Signal Receptor of the unit, as this could cause damage to the unit.

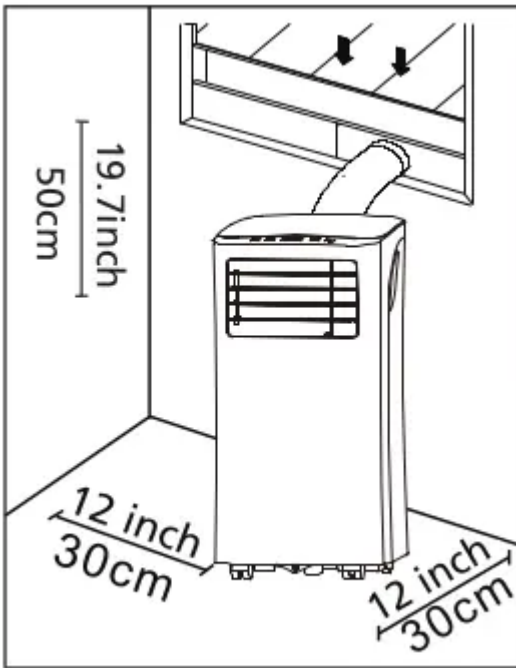

Recommend Installation

All the illustrations in the manual are for explanation purpose only. Your machine may be slightly different.

The unit can be controlled by the unit control panel alone or with the remote controller. See the Remote Controller Instruction for details.

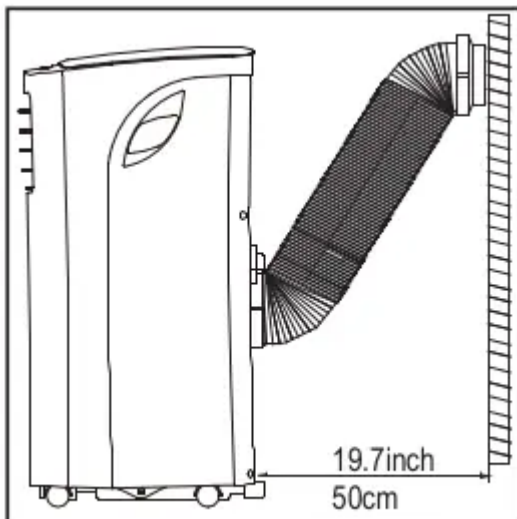

Note:

- * This air-conditioning unit is a hermetically sealed unit that contains fluorinated gasses. For specific information on the type of gas and the amount, please refer to the relevant label on the unit itself.











- * Service, maintenance and repair of this unit must be performed by a certified technician.
- + Product recycling must be done according to local regulations.

Tools Needed

- Medium Phillips screwdriver
- Tape measure or ruler
- Knife or scissors
- Saw (optional, to shorten window adaptor for narrow windows).

Accessories

Your Window Installation Kit fits windows 67.5-123 cm (26.5"-48") and can be shortened for smaller windows.

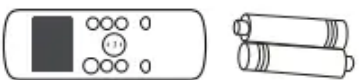
Part	Description	Quantity
	Unit adaptor	1 pc
	Exhaust hose	1 pc
	Window slider adaptor	1 pc
	Bolt	3 pcs
	Window slider A	1 set
	Foam seal A (adhesive)	4 pcs
	Foam seal B (adhesive)	2 pcs
	Foam seal C (Non-adhesive)	2 pcs
	Security bracket and 2 screws	1 set
	Drain hose	1 pc
	remote control and batteries (For remote control models only)	1 set

Window Installation Kit

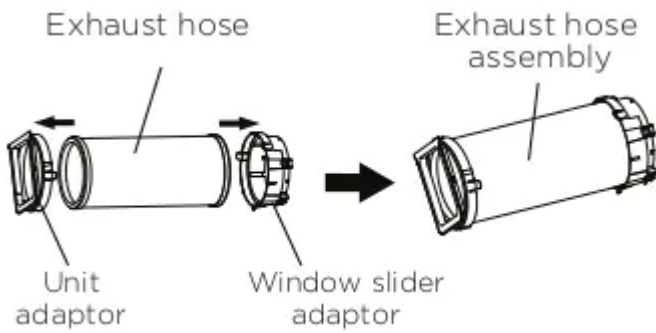

Step One: Preparing the exhaust hose assembly

Press the exhaust hose into the window slider adaptor and unit adaptor, clamp automatically by elastic buckles of the adaptors.

Step Two: Install the exhaust hose assembly to the unit

Push the Exhaust hose into the air outlet opening of the unit along the arrow direction.

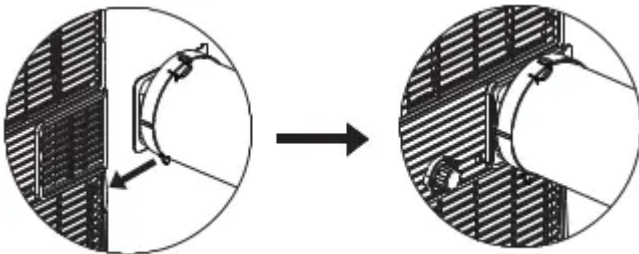

Step Three: Preparing the adjustable window slider

1. Depending on the size of your window, you may need to adjust the size of the window slider.
2. If the length of the window requires two window sliders, use the bolt to fasten the window sliders once they are adjusted to the proper length

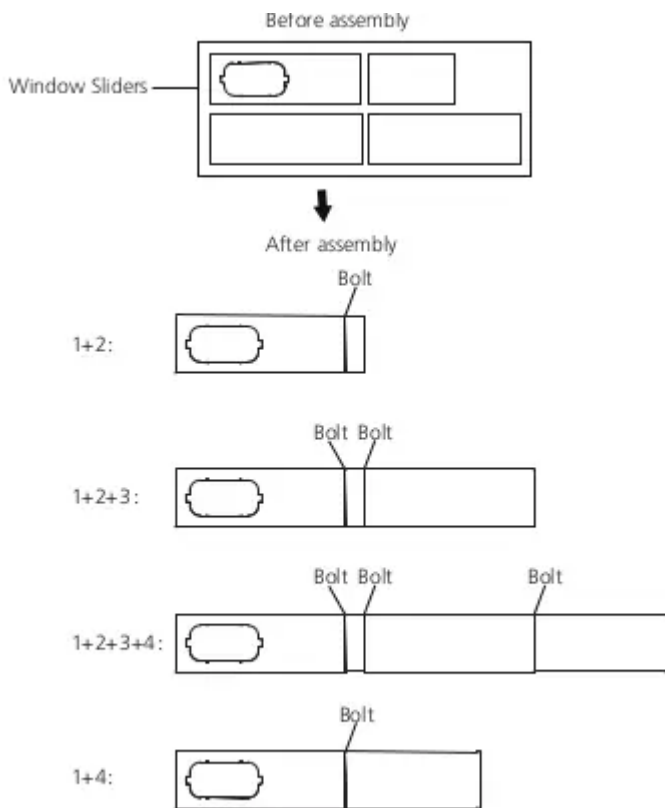

NOTE: Once the Exhaust Hose assembly and Adjustable Window Slider are prepared, choose from one of the following two installation methods.

Window Installation Kit (cont.)

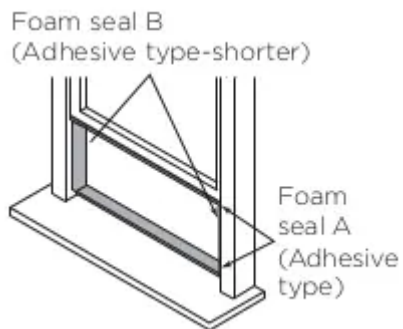

Type 1: Hung window installation

1. Cut the adhesive foam seal A and B strips to the proper lengths, and attach them to the window sash and frame as shown.

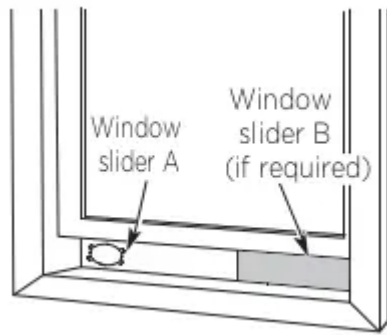

2. Insert the window slider assembly into the window opening.

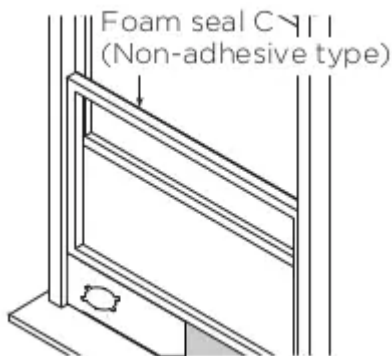

3. Cut the non-adhesive foam seal C strip to match the width of the window. Insert the seal between the glass and the window frame to prevent air and insects from getting into the room

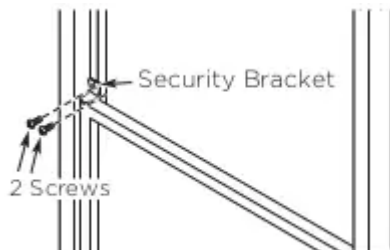

4. If desired, install the security bracket with 2 screws as shown.

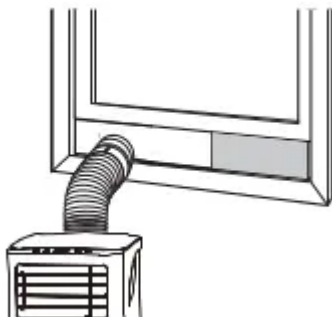

5. Insert the window slider adaptor into the hole of the window slider.

Type 2: Sliding window installation

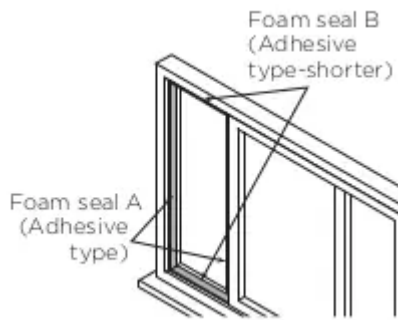

1. Cut the adhesive foam seal A and 8 strips to the proper lengths, and attach them to the window sash and frame as shown.

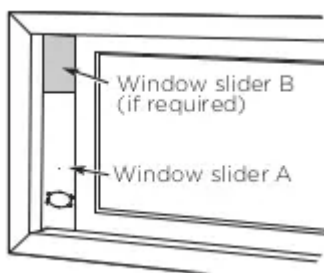

2. Insert the window slider assembly into the window opening.

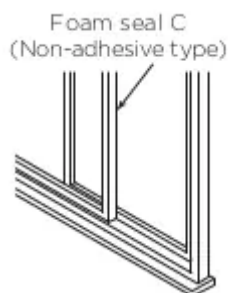

- Cut the non-adhesive foam seal C strip to match the window height. Insert the foam seal between the glass and the window frame to prevent air and insects from getting into the room.

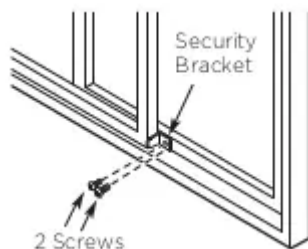

4. If desired, install the security bracket with 2 screws as shown

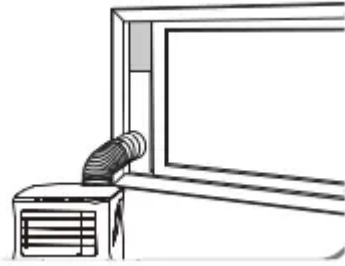

NOTE

To ensure proper functioning, DO NOT overextend or bend the hose. Make sure that there is no obstacle around the air outlet of the exhaust hose (in the range of approx. 20 inches) in order for the exhaust system to work properly. All illustrations in this manual are for explanation purposes only. Your air conditioner may be slightly different than the illustrations shown here.



Care and Cleaning

Safety Precautions

- + Always unplug the unit before cleaning or servicing.
- + DO NOT use flammable liquids or chemicals to clean the unit.
- + DO NOT wash the unit under running water. Doing so causes electrical danger.
- + DO NOT operate the machine if the power supply was damaged during cleaning. A damaged power cord must be replaced with a new cord from the manufacturer.

Clean the Air Filter

Maintenance Tips

- + Be sure to clean the air filter every 2 weeks for optimal performance.
- + The water collection tray should be drained immediately after PI error occurs, and before storage to prevent mold.
- + In households with animals, you will have to periodically wipe down the grill to prevent blocked airflow due to animal hair.

Caution: DO NOT operate the unit without filter because dirt and lint will clog it and reduce performance.

Clean the Unit

Clean the unit using a damp, lint-free cloth and mild detergent. Dry the unit with a dry, lint-free cloth.

Store the Unit When Not in Use

- + Drain the unit's water collection tray according to the instructions in the following section
- + Run the unit on FAN mode for 12 hours in a warm room to dry it and prevent mold
- + Turn off the unit and unplug it.
- + Clean the air filter according to the instructions in the previous section. Reinstall the clean, dry filter before storing
- + Remove the batteries from the remote control

NOTE: Be sure to store the unit in a cool, dark place. Exposure to direct sunlight or extreme heat can shorten the lifespan of the unit.

Troubleshooting Tips

Malfunction Diagnosis

Please check the following troubleshooting methods before calling for service:

Unit does not turn on when pressing ON/ OFF button:

Cause: P1 Error Code.

Solution: The water collection tray is full Turn off the unit, drain the water from the water collection tray and restart the unit.

Cause: In COOL mode: room temperature is lower than the set temperature.

Solution: Reset the temperature.

Unit does not cool well

Cause: The air filter is blocked with dust or animal hair.

Solution: Turn off the unit and clean the filter according to instructions.

Cause: Exhaust hose is not connected or is blocked.

Solution: Turn off the unit, disconnect the hose, check for blockage and reconnect the hose.

Cause: The unit is low on refrigerant

Solution: Call a service technician to inspect the unit and top off refrigerant.

Cause: Temperature setting is too high.

Solution: Decrease the set temperature.

Cause: The windows and doors in the room are open.

Solution: Make sure all windows and doors are closed.

Cause: The room area is too large

Solution: Double-check the cooling area.

Cause: There are heat sources inside the room

Solution: Remove the heat sources if possible.

The floor is not level.

Cause: The floor is not level.

Solution: Place the unit on a flat, level surface.

Cause: The air filter is blocked with dust or animal hair.

Solution: Turn off the unit and clean the filter according to instructions.

The unit makes a gurgling sound

Cause: This sound is caused by the flow of refrigerant inside the unit.

Solution: This is normal.

Remote Control Instructions

Using The Remote Control

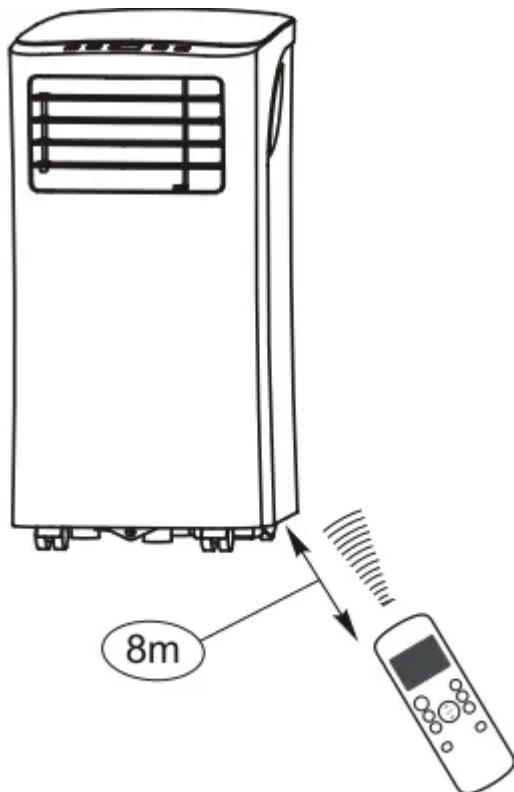

Location of the remote controller

Use the remote controller within a distance of 8 meters / 26 feet from the appliance, pointing it towards the receiver. Reception is confirmed by a beep.

Caution:

- The air conditioner will not operate if curtains, doors or other materials block the signals from the remote controller to the indoor unit.
- Prevent any liquid from falling into the remote controller. Do not expose the remote controller to direct sunlight or heat.
- If the infrared signal receiver on the indoor unit is exposed to direct sunlight, the air conditioner may not function properly. Use curtains to prevent the sunlight from falling on the receiver.
- If other electrical appliances react to the remote controller, either move these appliances or call customer support.

Remote Control Specifications

Model	RG57H1(B)/BGCEU1-M
Rated voltage	3.0V (Dry batteries R03/LR03x2)
Signal receiving range	8 m (approx. 26 ft.)
Environment	-5°C - 60°C (23°F - 140°F)

Function Buttons

Before you begin using your new air conditioner, make sure to familiarize yourself with its remote control. The following is a brief introduction to the remote control itself. For instructions on how to operate your air conditioner, refer to the Operating Instructions section of this manual.



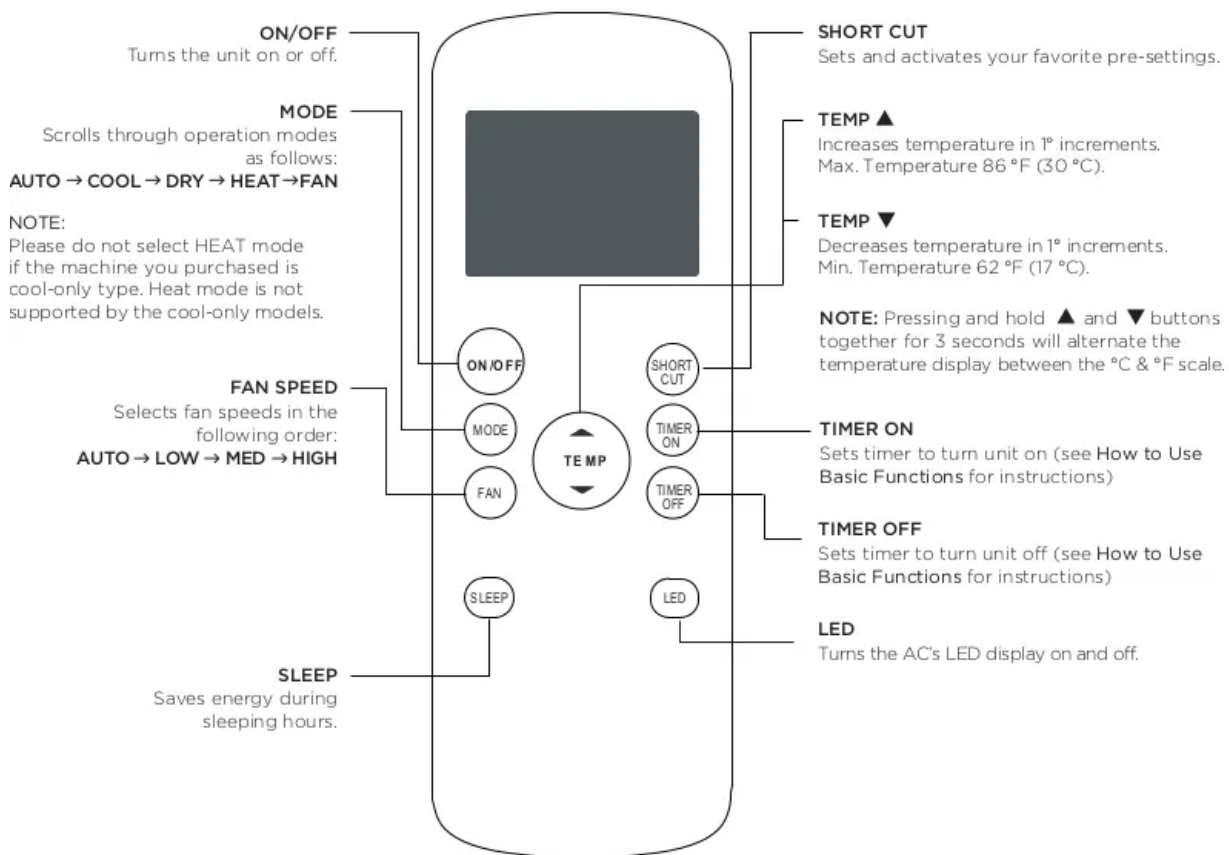

Handling the Remote Control

Not sure what a function does?

Refer to the Operating Instructions section of this manual for detailed descriptions of the functions available using the remote.

Notice: Button designs on your unit may differ slightly from the examples below. If the unit does not have a specific function, using that function's button on the remote control will have no effect.

INSERTING AND REPLACING BATTERIES

Your air conditioning unit comes with two AAA batteries. Insert the batteries in the remote control before use.

1. Slide the back cover of the remote control downward, exposing the battery compartment.
2. Insert the batteries, paying attention to align the (+) and (-) ends of the batteries with the symbols inside the battery compartment.
3. Slide the battery cover back into place.

BATTERY NOTES

For optimum product performance:

- * Do not mix old and new batteries, or batteries of different types.

* Do not leave batteries in the remote control if you don't plan on using the device for more than 2 months.

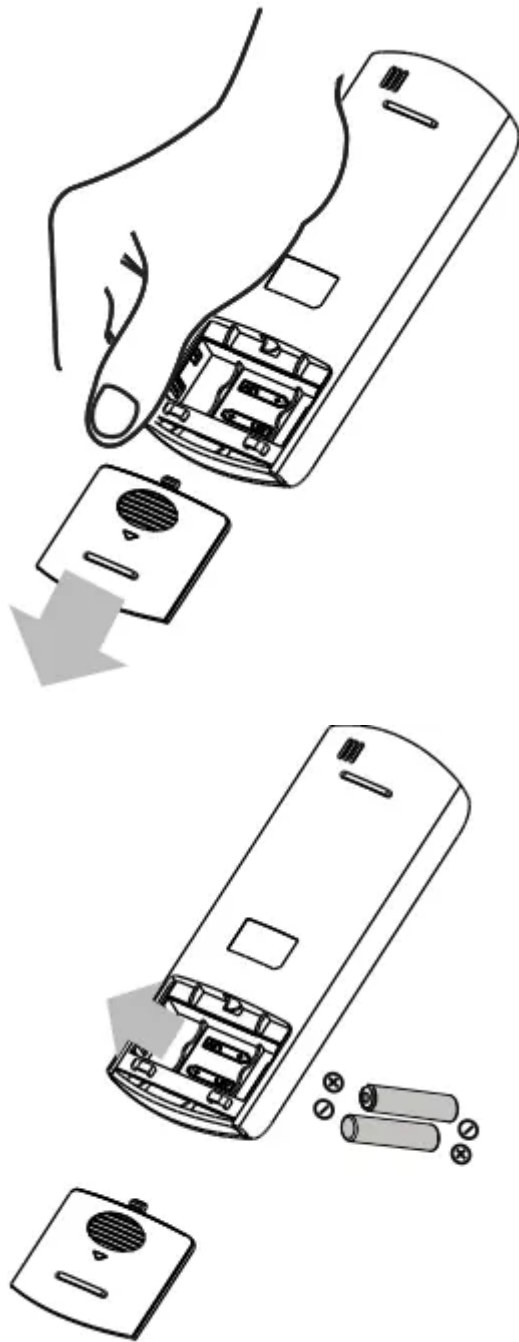

BATTERY DISPOSAL

Ensure used batteries are disposed of properly.

TIPS FOR USING REMOTE CONTROL

- The remote control must be used within 26 feet/ 8 meters of the unit.
- The unit will beep when it receives a signal from the remote.
- Curtains, other materials, and direct sunlight can interfere with the IR signal receiver.
- In order to properly transmit a command, the ON/

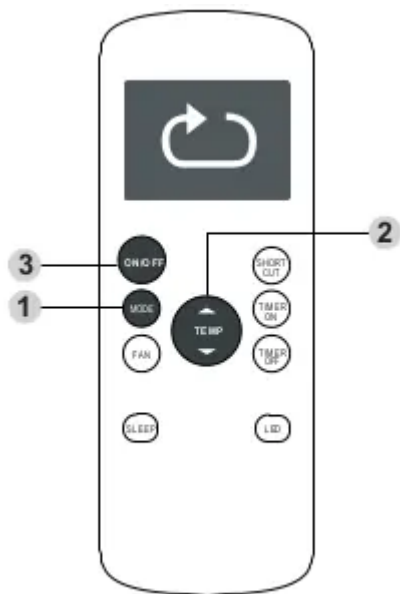

CHANGING THE MODE

1. To change the operating mode, press the MODE button until the desired mode appears on the remote's display.
2. Set the desired temperature.

NOTICE: If the unit does not change when the button is pressed, check that the ON/OFF indicator is illuminated. If it is not, point the remote at the unit and press the ON/OFF button.

Changing the Fan Speed

1. To change the fan speed, press the FAN button until the desired fan speed appears on the remote's display.

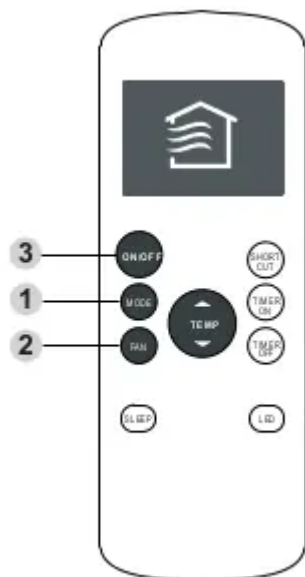

NOTICE: If the unit does not change when the button is pressed, check that the ON/OFF indicator is illuminated. If it is not, point the remote at the unit and press the ON/OFF button.

Timer Functions

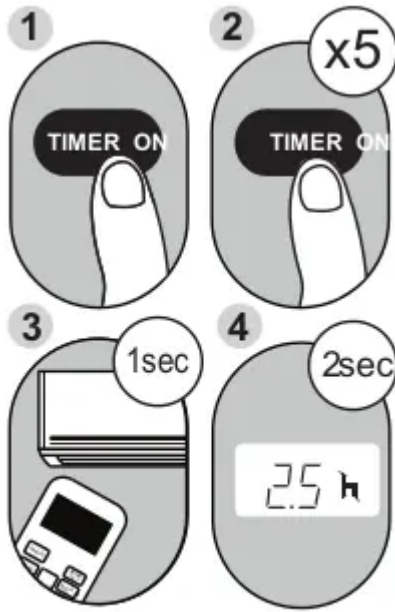

Example: Setting unit to turn on after 2.5 hours.

Your air conditioning unit has two timer-related functions:

TIMER ON - sets the amount of time after which the unit will automatically turn on.

TIMER OFF - sets the amount of time after which the unit will automatically turn off.

TIMER ON function

The TIMER ON function allows you to set a period of time after which the unit will automatically turn on, such as when you come home from work.

1. Press the TIMER ON button. By default, the last time period that you set and an “h” (indicating hours) will appear on the display.

NOTICE: This number indicates the amount of time after the current time after which you want the unit to turn on.

For example, if you set TIMER ON for 2 hours, “2.0h” will appear on the screen, and the unit will turn on after 2 hours.

2. Press the TIMER ON button repeatedly to set the time that you want the unit to turn on.

3. Wait 2 seconds, then the TIMER ON function will be activated. The digital display on your remote control will then return to the temperature display.

TIMER OFF function

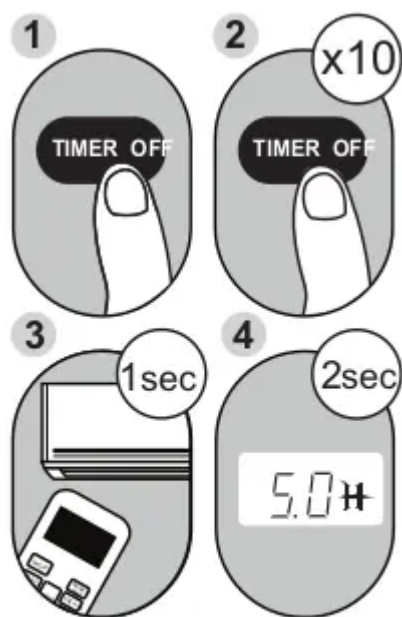

Example: Setting unit to turn off after 5 hours.

The TIMER OFF function allows you to set a period of time after which the unit will automatically turn off, such as when you wake up

1. Press the TIMER OFF button. By default, the last time period that you set and an “h” (indicating hours) will appear on the display.

NOTICE

This number indicates the amount of time after the current time after which you want the unit to turn off.

For example, if you set TIMER OFF for 2 hours, “2.0h*” will appear on the screen, and the unit will turn off after 2 hours.

2. Press the TIMER OFF button repeatedly to set the time that you want the unit to turn off.

3. Wait 2 seconds, then the TIMER OFF function will be activated. The digital display on your remote control will then return to the temperature display.

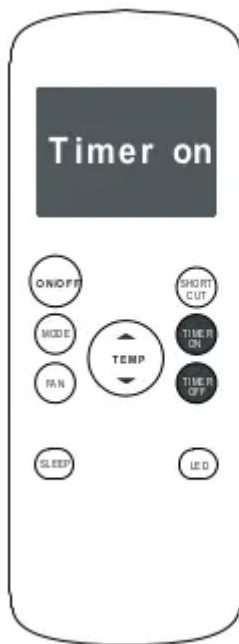

Continue to press **TIMER ON** or **TIMER OFF** until desired time is reached.

NOTE: When setting the **TIMER ON** or **TIMER OFF** functions, up to 10 hours, the time will increase in 30 minute increments with each press. After 10 hours and up to 24, it will increase in 1 hour increments. The timer will revert to zero after 24 hours. You can turn off either function by setting the timer to "0.0h".

Setting both **TIMER ON and **TIMER OFF** at the same time**

Keep in mind that the time periods you set for both functions refer to hours after the current time.

For example, say that the current time is 1:00 PM, and you want the unit to turn on automatically at 7:00 PM and want it to operate for 2 hours, then automatically turn off at 9:00 PM

Do the following (side figure):

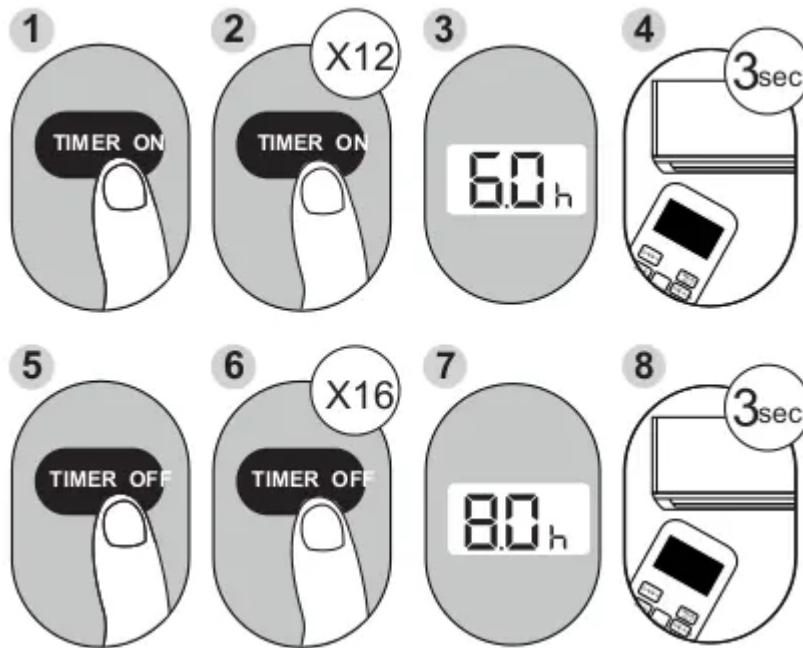

Example: Setting the unit to turn on after 6 hours, operate for 2 hours, then turn off (see the figure below)

Your remote display

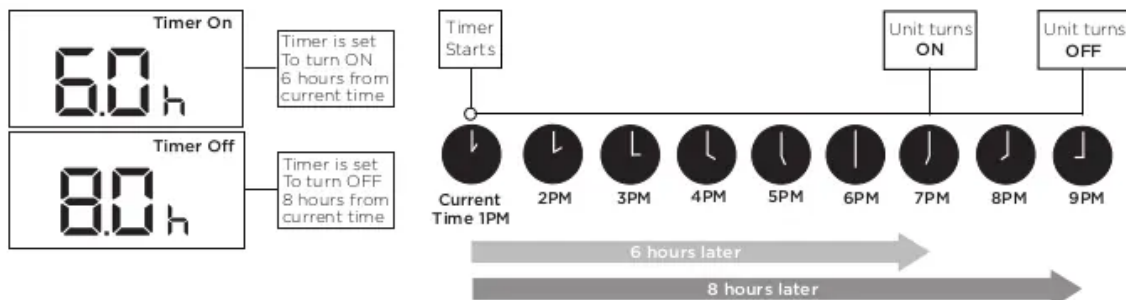

Advanced Functions

SLEEP Function

The SLEEP function is used to decrease energy use while you sleep (and don the same temperature settings to stay comfortable).

Note: The SLEEP function is not available in FAN or DRY mode.

SHORTCUT Function

Used to restore the current settings or resume previous settings.

Push this button when remote controller is on. the system will automatically revert back to the previous settings including operating mode. setting temperature, fan speed level and sleep feature (if activated).

By pressing for more than 2 seconds, the system will automatically store the current operation settings including operating mode. setting temperature, fan speed level and sleep feature (if activated).

SLEEP Function

The SLEEP function is used to decrease energy use while you sleep (and don't need the same temperature settings to stay comfortable).

Note: The SLEEP function is not available in FAN or DRY mode.

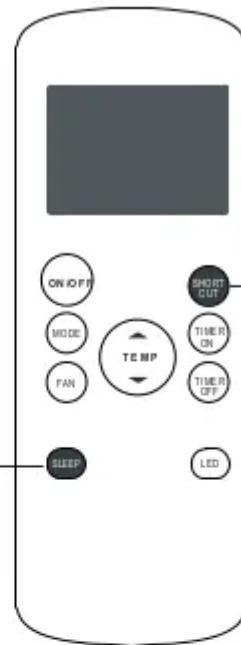

SHORTCUT Function

- Used to restore the current settings or resume previous settings.
- Push this button when remote controller is on, the system will automatically revert back to the previous settings including operating mode, setting temperature, fan speed level and sleep feature (if activated).
- By pressing for more than 2 seconds, the system will automatically store the current operation settings including operating mode, setting temperature, fan speed level and sleep feature (if activated).

Warranty

Your product is protected by this Limited Warranty:

Warranty service must be obtained from Midea Consumer Services or an authorized Midea servicer.

Warranty

+ One year limited warranty from original purchase date.

Midea, through its authorized servicers

+ Pay all costs for repairing or replacing parts of this appliance which prove to be defective in materials or workmanship.

Consumer will be responsible for:

- + Diagnostics, removal, transportation and reinstallation cost required because of service.
- + Costs of service calls that are a result of items listed under NORMAL RESPONSIBILITIES OF THE CONSUMER**

Midea replacement parts shall be used and will be warranted only for the original warranty.

NORMAL RESPONSIBILITIES OF THE CONSUMER

This warranty applies only to products in ordinary household use, and the consumer is responsible for the items listed below:

1. Proper use of the appliance in accordance with instructions provided with the product.
2. Routine maintenance and cleaning necessary to keep the good working condition.
3. Proper installation by an authorized service professional in accordance with instructions provided with the appliance and in accordance with all local plumbing, electrical and/or gas codes.
4. Proper connection to a grounded power supply of sufficient voltage, replacement of blown fuses, repair of loose connections or defects in house wiring
5. Expenses for making the appliance accessible for servicing
6. Damages to finish after installation

EXCLUSIONS

This warranty does not cover the following:

- 1) Failure caused by damage to the unit while in your possession (other than damage caused by defect or malfunction), by its improper installation, or by unreasonable use of the unit, including without limitation, failure to provide reasonable and necessary maintenance or to follow the written installation and Operating Instructions
- 2) Damages caused by services performed by persons other than authorized Midea customer service; or external causes such as abuse, misuse, inadequate power supply or acts of God
- 3) If the unit is put to commercial, business, rental, or other use or application other than for consumer use, we make no warranties, express or implied, including but not limited to, any implied warranty of merchantability or fitness for use or purpose.
- 4) Products without original serial numbers or products that have serial numbers which have been altered or cannot be readily determined

NOTE: Some states do not allow the exclusions or limitation of incidental or consequential damages. So this limitation or exclusion may not apply to you.

IF YOU NEED SERVICE

Keep your bill of sale, delivery slip, or some other appropriate payment Record.

The date on the bill establishes the warranty period, should service be required.

If service is performed, its your best interest to obtain and keep all receipts.

This written warranty gives you specific legal rights. You may also have other rights that vary from state to state. Service under this warranty must be obtained by following these steps, in order:

- 1) Contact Midea Consumer Services or an authorized Midea services at 1866 646 4332.
- 2) If there is a question as to where to obtain service, contact our consumer relations Department.

Warning

This content is compiled from multiple sources and is provided for reference purposes only. It may not be complete or fully applicable to all situations. If you are unable to resolve your issue, please contact the product manufacturer or an authorized service provider for official support.

