

What's included

Make sure all the parts are included in the product package. If you have a problem with the washing machine or the parts, contact a local Samsung customer centre or the retailer.

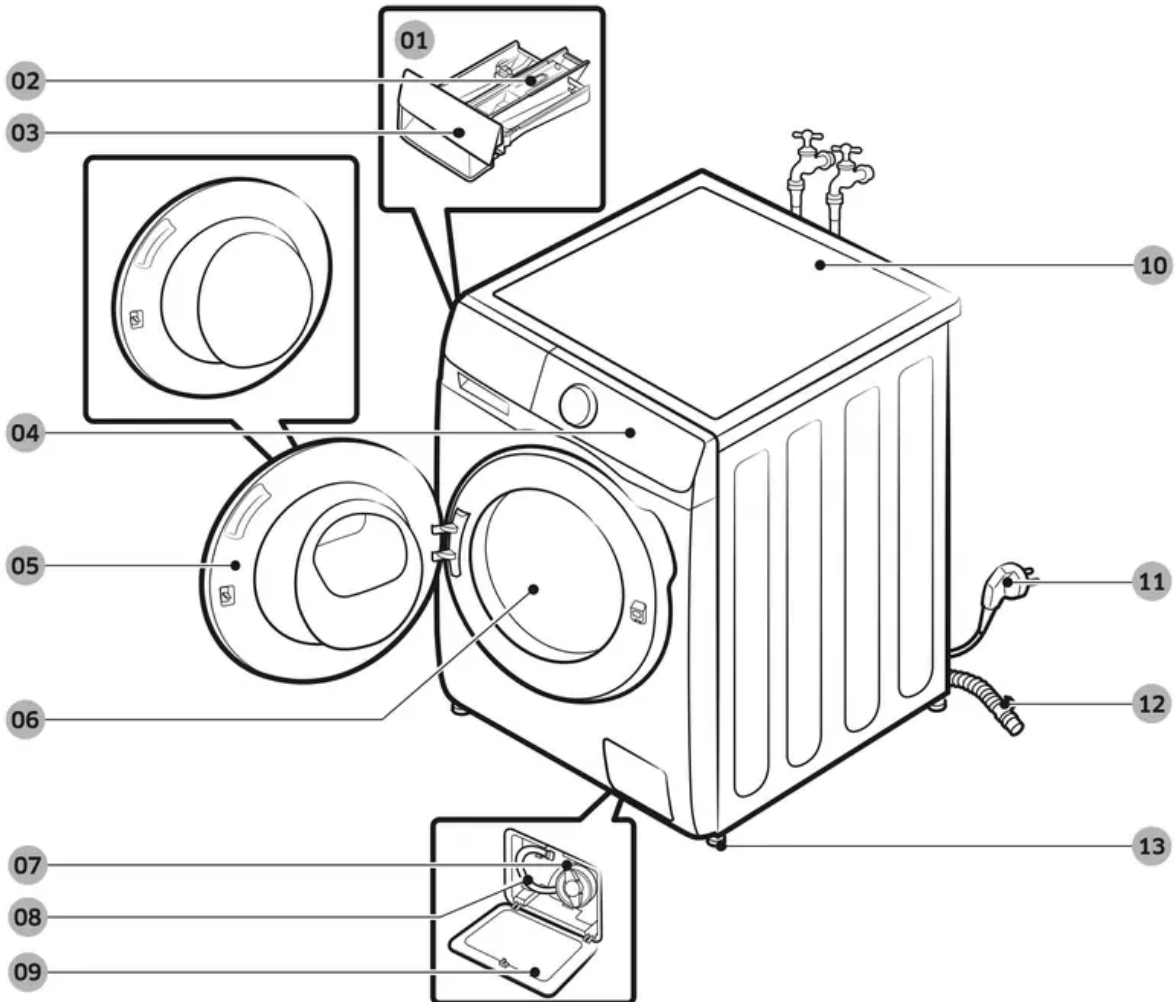

1. Manual dispenser
2. Release lever
3. Detergent drawer
4. Control panel
5. Door
6. Drum
7. Debris filter
8. Emergency drain tube
9. Filter cover









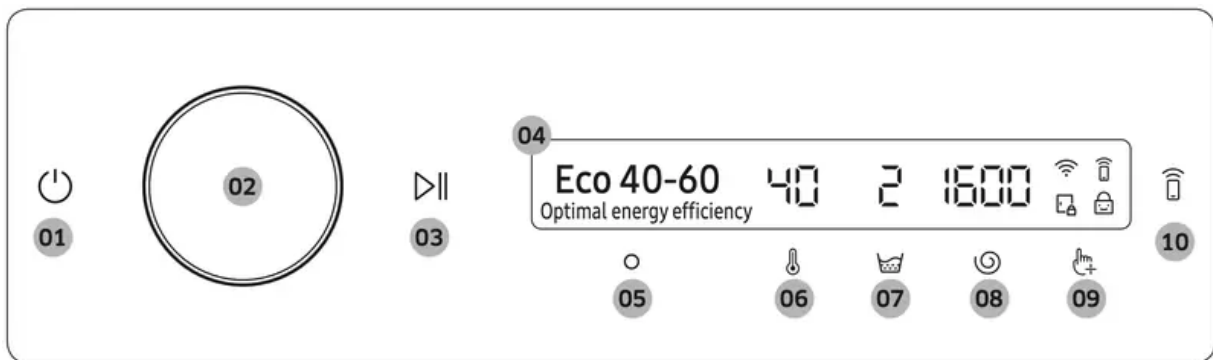

- 10. Worktop
- 11. Power plug
- 12. Drain hose
- 13. Levelling feet

* The design of the drawer and/or the lever differs with the model.





Operations

Control panel









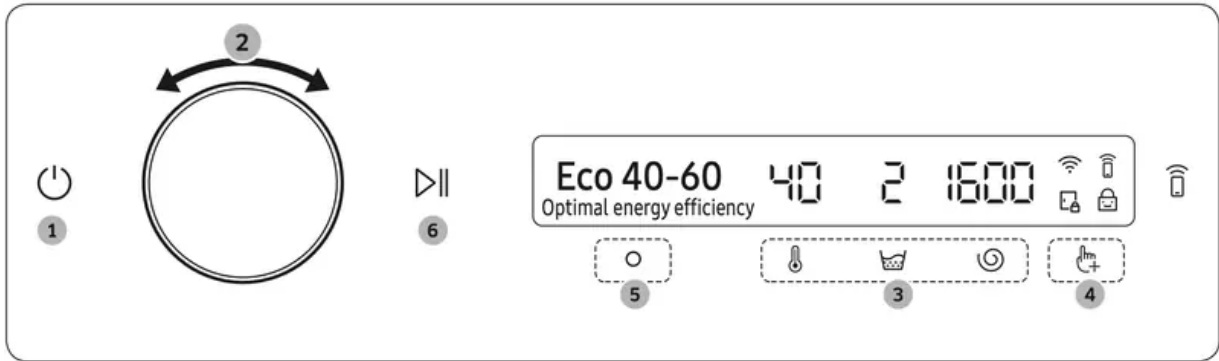

01 Power 	<p>Tap to turn the washing machine on or off.</p> <ul style="list-style-type: none"> If you do not manipulate the control panel for 10 minutes after the washing machine is turned on, the washing machine automatically turns off. The washing machine automatically turns off when the cycle completes. <p>⚠ CAUTION</p> <p>Do not tap  to turn the washing machine off while the wash cycle is in progress. Tap and hold  to pause the cycle first, and then tap  to turn the washing machine off.</p>
02 Navigation dial	<p>Turn the navigation dial left or right to navigate through cycles and functions. When you turn the navigation dial, LCD displays your selection (such as cycle, additional functions, and system functions).</p>
03 Start/Pause 	<p>Tap and hold to start or pause an operation.</p>
04 Display	<p>The display shows current cycle information and estimated time remaining, or an information message when a problem occurs.</p>
05 OK 	<p>Tap to confirm your selection of function or setting.</p>
06 Temp. 	<p>Tap to change the water temperature for the selected cycle.</p> <ul style="list-style-type: none"> The indicator above the button indicates the default or selected setting.
07 Rinse 	<p>Tap to change the rinse count for the selected cycle.</p> <ul style="list-style-type: none"> The indicator above the button indicates the default or selected setting.
08 Spin 	<p>Tap to change the spin speed for the selected cycle.</p> <ul style="list-style-type: none"> The indicator above the button indicates the default or selected setting.
09 Additional function 	<p>Tap to enter the additional functions menu. Tap and hold for 3 seconds to enter the system functions menu.</p>
10 Smart Control 	<p>Tap to activate or deactivate the Smart Control function. Tap and hold to enter pairing mode to connect to the SmartThings app.</p> <ul style="list-style-type: none"> When the Smart Control function is activated, you can control your washing machine remotely using the SmartThings app on your smartphone or tablet (Android or iOS).

Icon descriptions

	Wi-Fi	<ul style="list-style-type: none"> This icon indicates that the washing machine is connected to Wi-Fi.
	Smart Control	<ul style="list-style-type: none"> This icon indicates that Smart Control is on. For more information on Smart Control, see page 45.
	Door Lock	<ul style="list-style-type: none"> This icon indicates the door is locked and cannot be opened. The door locks automatically during a cycle and this indicator turns on. You can open the door when this icon disappears.
	Child Lock	<ul style="list-style-type: none"> This icon indicates that Child Lock is on. For more information on Child Lock, see page 41.

Operating a cycle



1. Tap  turn on the washing machine.
2. Turn the Navigation dial to select the cycle you want.
For more information on Cycle overview, see page 37.
3. Tap , , or  to change the default cycle settings.
4. Tap , and then turn the Navigation dial to select additional function.
For more information on Additional functions, see page 40.
5. Tap  to change the settings for selected additional function.
Not all cycles have additional functions available.
6. Tap and hold  to start operation.
Once you set the cycle you want, the screen displays a brief cycle description, maximum laundry load, and cycle time. You can also check the cycle progress, remaining cycle time, and information codes.

Cycle overview

Cycle	Description	Max load (kg)
Eco 40-60	<ul style="list-style-type: none"> For cleaning normally soiled cotton items which are declared to be washable at 40 °C or 60 °C, together in the same cycle. This cycle is used to assess the compliance with the EU Ecodesign legislation. This cycle is set as a default. 	Max
Cotton	<ul style="list-style-type: none"> For cottons, bed linens, table linens, underwear, towels, or shirts. The washing time and the rinse count are automatically adjusted according to the load. For cleaning lightly soiled cotton items at a nominal temperature of 20 °C. 	Max
AI Wash (WW**T98****, WW**T93**** models only)	<ul style="list-style-type: none"> Adjusts the amount of detergent and the cycle according to the load and the soil severity. This cycle is best used with the Auto Dispense function. 	Max
15' Quick Wash	<p>For lightly soiled items in less than 2.0 kg that you want to wash quickly.</p> <ul style="list-style-type: none"> Use less than 20 g of detergent. Using more than 20 g of detergent may leave detergent residue. For liquid detergent, use a max of 20 ml of liquid detergent. 	2
Super Speed (WW**T9*****, WW**T8*****, WW**T7*****, WW**T6***** models only)	<ul style="list-style-type: none"> Fast completion within 39 minutes for everyday items such as underwear and shirts. The cycle time will differ depending on the water supply conditions, load, and type of laundry. 	5
Intense Cold	<ul style="list-style-type: none"> Low temperature ecobubble cycle helps reduce power consumption. 	4
Wool	<ul style="list-style-type: none"> Specific for machine-washable wool for loads less than 2.0 kg. The Wool cycle features fine pulsating and soaking to protect the wool fibres from shrinkage/distortion. A neutral detergent is recommended. 	2
Bedding	<ul style="list-style-type: none"> For bed spreads, bed sheets, bedding covers, etc. For best results, wash only 1 type of bedding and make sure the load weighs less than 2.0 kg. 	2

Cycle	Description	Max load (kg)
Outdoor	<ul style="list-style-type: none"> For outdoor clothes, skiwear, and sportswear that are made of functional materials such as spandex, stretch, and micro-fibre. 	2
Shirts	<ul style="list-style-type: none"> For shirts, blouses that are made of cotton, synthetic fiber. 	2
Towels	<ul style="list-style-type: none"> For bath towels, washcloths, and mats. 	4
Hygiene Steam	<ul style="list-style-type: none"> Cotton and linen fabric which have been in direct contact with the skin, such as underwear. For optimum hygiene results select a temperature of 60 °C or above. Steam cycles feature allergy care and bacteria elimination (sterilize). 	4
Baby Care	<ul style="list-style-type: none"> Featuring a high-temperature wash and extra rinses to help remove the remaining detergent effectively. 	4
Rinse+Spin	<ul style="list-style-type: none"> Featuring an additional rinse process after applying fabric softener to the laundry. 	Max
Drain/Spin	<ul style="list-style-type: none"> For draining the water inside the drum and running an additional spin process to effectively remove moisture from laundry. 	Max
Drum Clean+ (WW**T9*****, WW**T8*****, WW**T7*****, WW**T6***** models only)	<ul style="list-style-type: none"> Cleans the drum by removing dirt and bacteria from it. Cleans the rubber door gasket by removing dirt from the gasket. Perform once every 40 washes with no detergent or bleach applied. Notification message appears after every 40 washes. Make sure the drum is empty. Do not use any cleaning agents for cleaning the drum. 	-
Drum Clean (WW**T5***** model only)	<ul style="list-style-type: none"> Cleans the drum by removing dirt and bacteria from it. Perform once every 40 washes with no detergent or bleach applied. Notification message appears after every 40 washes. Make sure the drum is empty. Do not use any cleaning agents for cleaning the drum. 	-
Cloudy Day	<ul style="list-style-type: none"> For optimum spin drying at high humid condition. 	Max
Activewear	<ul style="list-style-type: none"> For exercise wear such as sports jerseys, training pants, shirts/tops and other performance clothing. This cycle provides effective soil removal with controlled drum rotation for special fabric care. 	2



Cycle	Description	Max load (kg)
Colours	<ul style="list-style-type: none"> Featuring additional rinses and reduced spinning to ensure that the laundry is washed gently and rinsed thoroughly. 	4
Synthetics	<ul style="list-style-type: none"> For fabrics that are made of polyester (diolen, trevira), polyamide (perlon, nylon), or the like. 	4
Delicates	<ul style="list-style-type: none"> For sheer fabrics, bras, lingerie (silk), and other handwash-only fabrics. For best performance, use liquid detergent. 	2
Denim	<ul style="list-style-type: none"> Featuring a higher water level in the main wash and an extra rinse cycle to ensure that no powder detergent remains. 	3
Silent Wash	<ul style="list-style-type: none"> For reducing operating noise and vibration. 	4
Mixed Load (WW**T5***** model only)	<ul style="list-style-type: none"> For mixed load consisting of cotton and synthetic. 	4

NOTE



- Loading the household washing machine or the household washer-dryer up to the capacity indicated by the manufacturer for the respective cycles will contribute to energy and water savings.
- The noise and remaining moisture content are influenced by the spinning speed: the higher the spinning speed in the spinning phase, the higher the noise and the lower the remaining moisture content.
- The most efficient cycle in terms of energy consumption are generally those that perform at lower temperatures and longer duration.

Additional functions

Additional functions

1. Tap .
2. Turn the Navigation dial to select the desired additional function.
3. Tap  to change the selected function's settings or start the function.



NOTE

- To return to the main screen, tap again or turn the Navigation dial to select Back and tap .
- If the selected function is not supported, the "This function is currently not supported" message is displayed, and the  button is not activated.

- When you select an additional function, a brief help message appears for the first ten times of use.



Prewash

You can add a preliminary washing cycle before the main wash cycle.

1. Select a cycle and change the cycle settings as necessary.
2. Tap .
3. Turn the Navigation dial to select Prewash, and then tap .
4. Tap and hold .



Intensive

For badly soiled laundry. The operation time for each cycle is longer than normal.

1. Select a cycle and change the cycle settings as necessary.
2. Tap .
3. Turn the Navigation dial to select Intensive, and then tap .
4. Tap and hold .

Bubble Soak



This function helps remove a wide variety of stubborn stains. With Bubble Soak selected, laundry is thoroughly soaked in water bubbles for effective washing.

1. Select a cycle and change the cycle settings as necessary.
2. Tap .
3. Turn the Navigation dial to select Bubble Soak, and then tap .
Bubble Soak is available with and adds up to 30 minutes to these cycles: Cotton, Synthetics, Bedding, and Super Speed.
4. Tap and hold .

My Cycles

Add or remove cycles to create a personal cycle list.

1. Tap .





2. Turn the Navigation dial to select My Cycles, and then tap .
You can only edit a cycle to create a personal cycle when the washing machine is not operating.
3. Turn the Navigation dial to select a desired cycle.
4. Tap  to add or remove the selected cycle.
Addition and removal of the course is saved automatically.
5. Once you finish creating My Cycles, tap  to return to the cycles screen.

NOTE



- The Eco 40-60 and Drum Clean+ cycles cannot be removed from the cycles list.
- You can also edit My Cycles in the SmartThings app.



Delay End

You can set the washing machine to finish your wash automatically at a later time, choosing a delay of between 1 to 24 hours (in 1 hour increments). The hour displayed indicates the time the wash will finish.

1. Select a cycle and change the cycle settings as necessary.
 2. Tap .
 3. Turn the Navigation dial to select Delay End, and then tap .
 4. Turn the Navigation dial to select the desired time, and then tap .
 5. Tap and hold .
- Status shows in the display and the washing machine tumbles the drum to sense the weight of the load (if load sensing is preset for the selected cycle). When load sensing is complete, the display shows the remaining time until the end of the wash cycle.
- To cancel Delay End, tap  to restart the washing machine.

Child Lock



To prevent children or infants from accidentally starting or setting the washing machine, Child Lock locks all buttons except for  and .

1. Tap .
2. Turn the Navigation dial to select Child Lock, and then tap .

3. Tap  to select On or Off.



The Child Lock  icon turns on when the function is on.

NOTE:

- When Child Lock is on, all buttons are disabled except for  and . The washing machine door also locks.
- Tapping a button while Child Lock is on triggers an alarm with the “Child Lock On” message.
- You cannot open the door after a wash cycle when the Child Lock is on. Turn the function off before opening the door to take out the laundry.

System functions



Using System Functions

1. Tap and hold  for 3 seconds.
2. Turn the Navigation dial and select the desired system function, and then tap .
3. Tap  to change the selected function's settings or start the function.

NOTE: To return to the main screen, tap again or turn the Navigation dial to select Back and tap .

AI Pattern

This function saves frequently used cycles and settings. When you turn the function on, the washing machine remembers the cycles you use most and their settings (Temp., Rinse, Spin) and displays them in frequency order.



1. Tap and hold  for 3 seconds.
2. Turn the Navigation dial to select AI Pattern, and then tap .
3. Tap  to select On or Off.

The default setting is On. Set it to Off if you do not want to use this function.

When you turn off the function, all the saved data resets.

Alarm



You can turn on or off the sound from the washing machine. When this function is set to Off, the AddWash alarm, the melody of cycle completion, and the power-off beep does not sound. However, the other sounds stay active.

1. Tap and hold  for 3 seconds.
2. Turn the Navigation dial to select Alarm, and then tap .
3. Tap  to select On or Off.
The default setting is On.

NOTE: The setting remains unchanged even if you restart the washing machine.



Calibration

You can run calibration again for accurate weight detection.

1. Tap and hold  for 3 seconds.
2. Turn the Navigation dial to select Calibration, and then tap .
Calibration does not start if the door is not closed properly.
The drum rotates clockwise and anticlockwise for about 3 minutes.
3. When calibration is complete, the "Calibration complete" message appears on the display and the washing machine turns off automatically.

Wi-Fi

You can turn the washing machine's Wi-Fi on or off.

1. Tap and hold  for 3 seconds.
2. Turn the Navigation dial to select Wi-Fi, and then tap .
3. Tap  to select On or Off.



The washing machine's Wi-Fi is off as a factory default setting. However, the washing machine's Wi-Fi turns on automatically when you turn on the washing machine for the first time. Then, the final Wi-Fi setting maintains regardless of the washing machine power status.

Once you turn on the washing machine's Wi-Fi and connect to a network, the washing machine remains connected to the network even when you turn off the power.

The Wi-Fi  indicates that the washing machine is connected to the router through the Wi-Fi connection.



Language

You can change the system language.

1. Tap and hold  for 3 seconds.
2. Turn the Navigation dial to select Language, and then tap .
3. Turn the Navigation dial to select the desired language, and then tap .

Factory Reset

You can reset the washing machine.

1. Tap and hold  for 3 seconds.
2. Turn the Navigation dial to select Factory Reset, and then tap .
Your washing machine resets to the factory setting.

Special features

AddWash (applicable models only)

To add laundry after the wash starts, use the AddWash door.

1. Tap and hold  to stop the wash cycle.
2. Press the upper area of the AddWash door to unlock the door. The door will move inward slightly when you press it and then open.

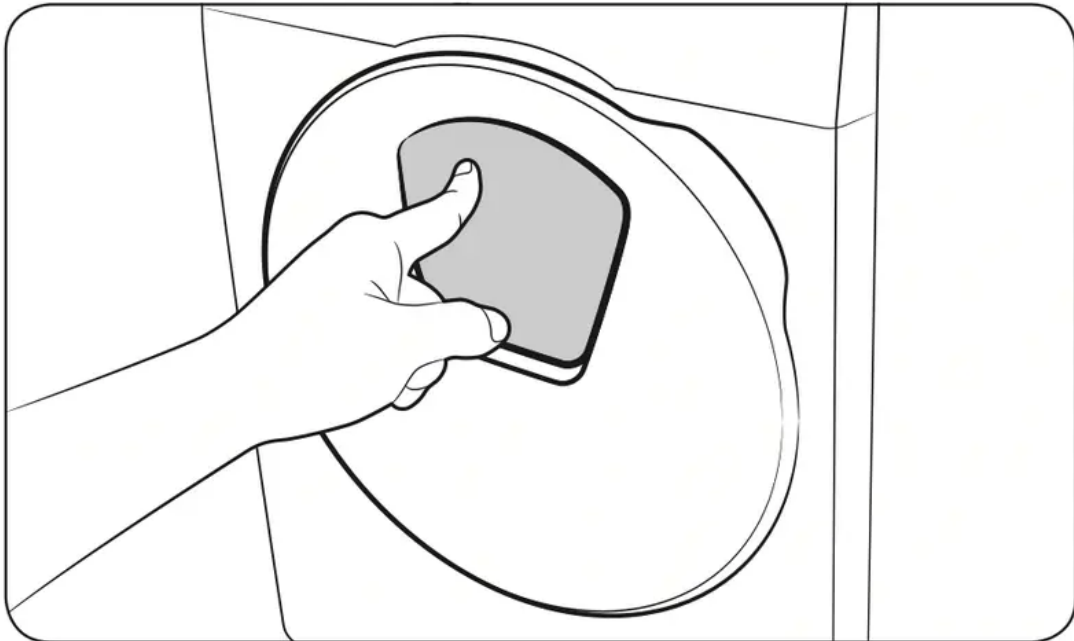

3. Open the AddWash door fully, and then insert additional laundry through the AddWash door into the drum.

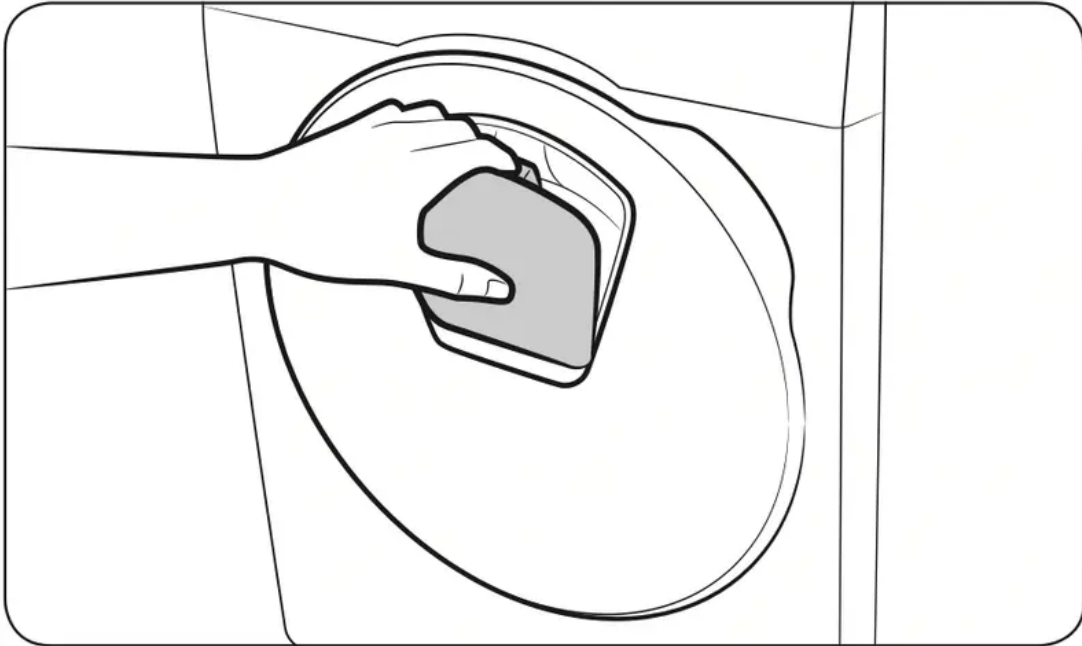

4. Lift the AddWash door back into position, and then lock the door by pushing the upper area of the door until you hear a click. Then, tap and hold  again to resume the wash cycle.



CAUTION: Do not put excessive force on the AddWash door. It may break.

NOTE: The water inside the drum does not leak if the AddWash door is closed properly. Water drops may form around the AddWash door, but water will not leak from inside the drum. This is normal.

CAUTION

- Do not open the AddWash door if suds have formed inside the drum that rise above the level of the Addwash door.
- Do not attempt to open the AddWash door while the machine is operating without first tapping and holding . Please note that the AddWash door can be opened unintentionally (without tapping and holding ) when the wash is complete.
- Do not add an excessive load through the AddWash door. Performance may be degraded.
- Do not use the lower area of the AddWash door as a handle. Your fingers may be caught.
- Make sure that no laundry is caught in the AddWash door.
- Keep your pets out of the washing machine, especially the AddWash door.
- When using hot water for the wash, the AddWash door may appear to leak water after opening and closing the AddWash door. This is normal, simply because steam emerging from the open AddWash door has cooled and formed water drops on the surface.

- When the AddWash door closes, the door seals up and no water can leak. However, you may encounter what appears to be water leak around the door - some residual water remaining around the AddWash door may form water drops. This is normal.
- Neither the main door nor the AddWash door can be opened when the water temperature is over 50 °C.
If the water level inside the drum is over a certain point, the main door cannot be opened.
- If an information code of 'DDC' appears on the display, see the Information codes section for further actions.
- Keep the AddWash door and its surroundings clean at all times. Debris or detergent on or around the seals of the AddWash door may cause a leak.



Adding laundry for non-AddWash models (applicable models only)

1. Tap and hold  to stop the wash cycle.
2. Open the door and add the laundry into the drum.
3. Close the door, and then tap and hold again to resume the wash cycle.

Smart control (applicable models only)

You can connect to the SmartThings app and control your washing machine remotely.

Connecting your washing machine

1. Download and open the SmartThings app on your smartphone or tablet (Android & iOS).
2. Tap  to turn on the washing machine.
3. Tap and hold  .
 - a. The washing machine enters AP mode and connects to your smartphone or tablet.
 - b. Tap  to authenticate your washing machine.
 - c. Once the authentication process is complete, your washing machine is successfully connected to the app.

You can use various features available in the SmartThings app.

NOTE

- If your washing machine fails to connect with the SmartThings app, try again.
- Check your router if you experience any Internet connection problem after connecting your washing machine with the SmartThings app.
- If the Wi-Fi is off, tap and hold  for 3 seconds to enter the System functions menu, and select Wi-Fi to turn it on.

- Turning the washing machine's Wi-Fi on allows you connect to the washing machine via SmartThings app on your smartphone or tablet, regardless of the power status of the washing machine. However, the washing machine appears offline on the SmartThings app if the washing machine's Wi-Fi is off.
- Close the door before starting the Smart Control function.
- If you use your washing machine for a while without connecting it to the SmartThings app, a pop-up message about Smart Control will show for 3 seconds.
- If the washing machine's Wi-Fi is not connected to an AP (access point), the Wi-Fi will turn off when you turn of the power.

Stay Connect

Set up the Stay Connect function in your SmartThings app to keep Smart Control turned on at the end of a cycle. Your washing machine stays connected to the app so you can send additional instructions, whether you are at home or away.

1. If you turn on the Stay Connect function on the SmartThings app, the washing machine will stay in standby power saving mode after completing a cycle.
The Stay Connect function will remain active for up to 7 days if the door remains closed.
2. When the Stay Connect function is active, the Smart Control, Door Lock, and Wi-Fi icons are illuminated on your washing machine display.
3. You can conveniently control your washing machine, adding rinse, spin or dry cycles using the SmartThings app.

NOTE

- The washing machine switches to standby power saving mode when operation is paused even if the machine is not connected to the SmartThings app.
- In some circumstances, only the Door Lock icon may be illuminated.

Maintenance

Keep the washing machine clean to prevent deteriorated performance and to preserve its life cycle.

Drum clean+

Perform this cycle regularly to clean the drum by removing bacteria from it. This cycle heats the water between 60 °C and 70 °C, and it also removes accumulated dirt from the rubber door gasket.

1. Tap  .
2. Turn the Navigation dial to select Drum Clean+.

3. Tap and hold .

CAUTION

- Do not use any cleaning agents for cleaning the drum. Chemical residue in the drum may cause damage to the laundry or the drum of the washing machine.
- To prevent limescale, add the proper amount of detergent according to your local water hardness or add a water softener additive together with the detergent.

DRUM CLEAN+ reminder

Depending on the model, the Drum Clean+ reminder is either an icon or an LED.

For icons, the icon lights up on the control panel.

For LEDs, the LED lights up next to Drum Clean+, or on the option area of the control panel.

- The Drum Clean+ reminder blinks on the control panel once every 40 washes. It is advisable to perform Drum Clean+ regularly.
- When you first see this reminder blinking, you can ignore the reminder for 6 consecutive washes. From the 7th wash, the reminder no longer appears. However, it appears again on the second 40th wash.
- Even after the last process is terminated, the "0" message may remain.
- You can record the running count of the Drum Clean+ cycle by pressing the Power button. This does not stop or turn off the machine but marks your cycle count.
- Even if "0" does not disappear, the machine operates normally.
- It is recommended to run the cycle regularly for hygienic purposes.

Emergency drain

In case of a power failure, drain the water inside the drum before taking out the laundry.

1. Power off and unplug the washing machine from the electrical outlet.

2. Gently press the top area of the filter cover to open.

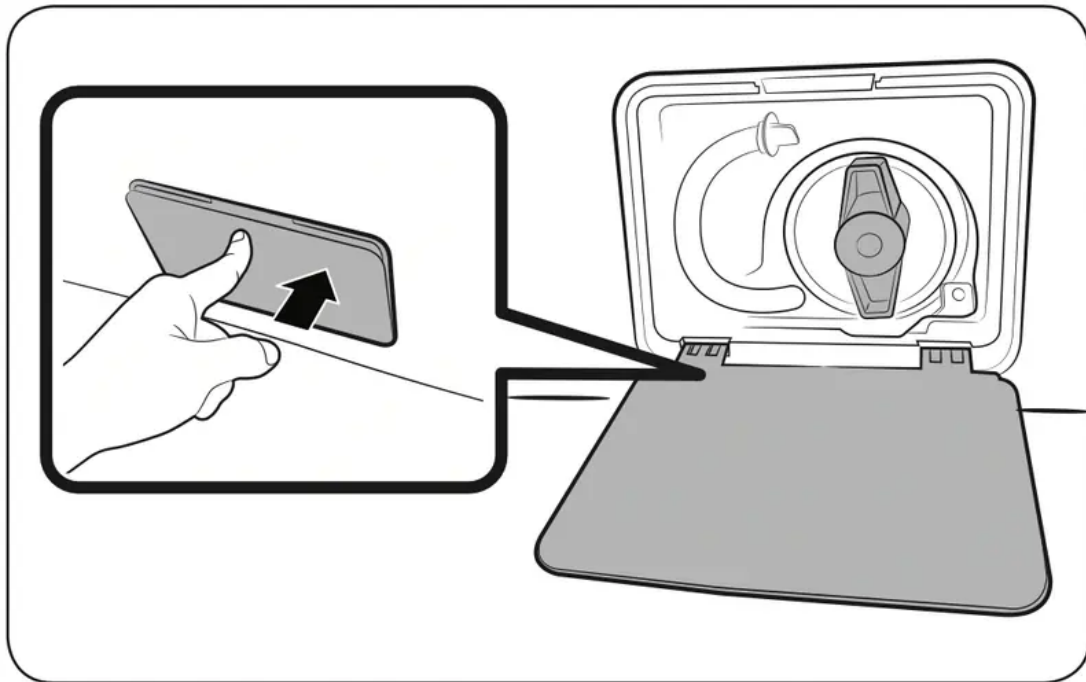

3. Put an empty, spacious container around the cover, and stretch the emergency drain tube to the container while holding the tube cap (A).

[image]

4. Open the tube cap and let water in the emergency drain tube (B) flow into the container.

5. When done, close the tube cap, and reinsert the tube. Then, close the filter cover.

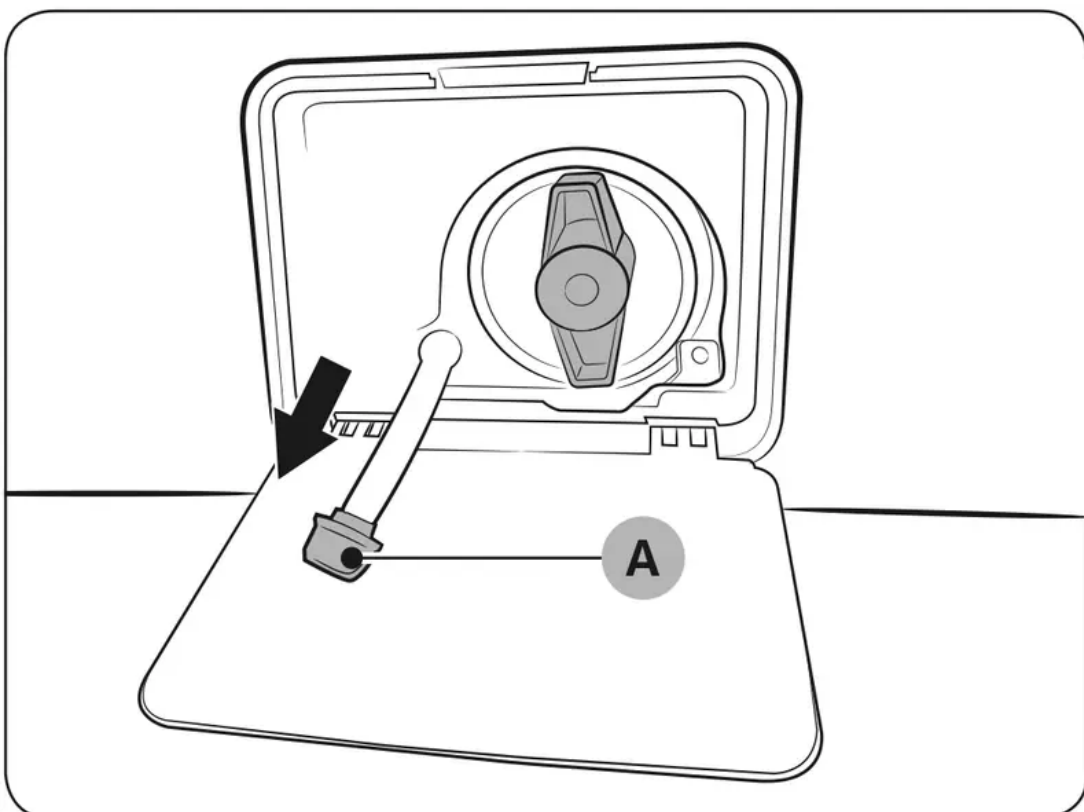

NOTE: Use a spacious container because the water in the drum may be more than expected.

Cleaning

Surface of the washing machine

Use a soft cloth with a nonabrasive household detergent. Do not spray water onto the washing machine.

AddWash door

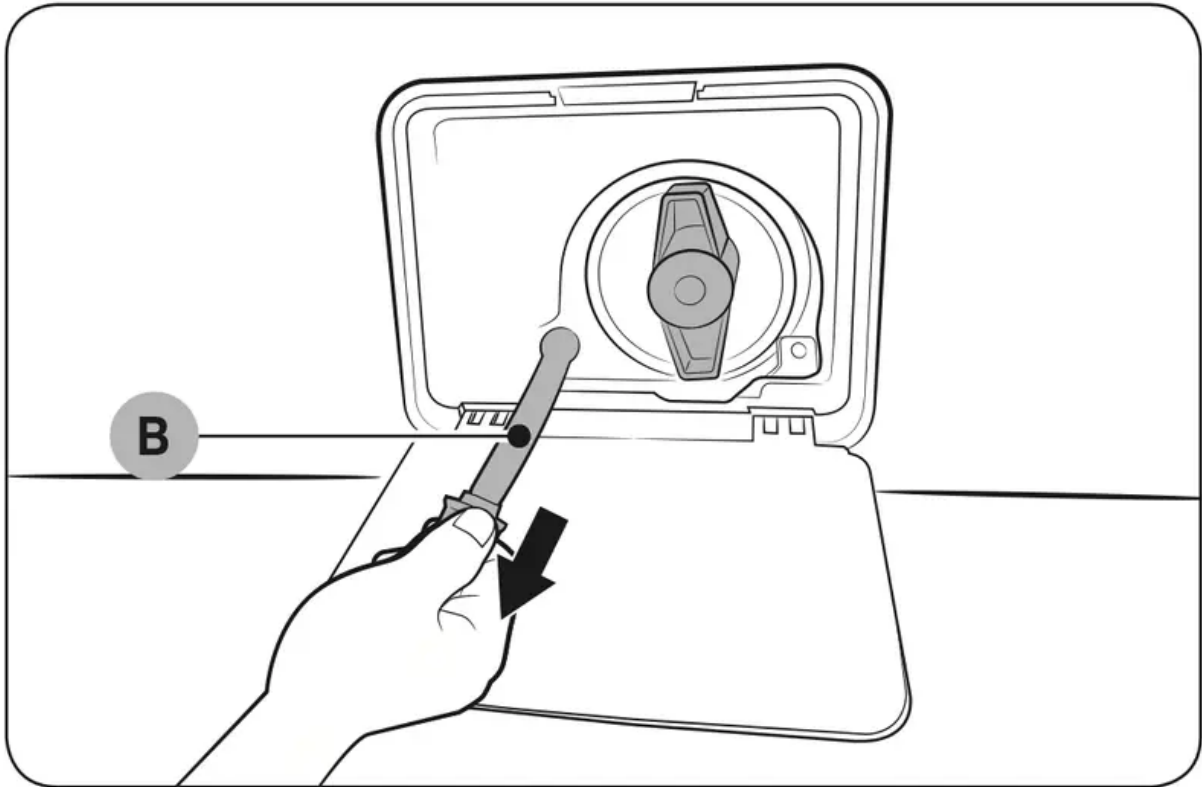

1. Open the AddWash door.
2. Use a wet cloth to clean the AddWash door.
Do not use cleaning agents. Discolouration may occur.
Use caution when cleaning the rubber packing and the locking mechanism (A).
Dust off the door area regularly.
3. Wipe up and close the AddWash door until you hear a clicking sound.

CAUTION

- Do not apply force on the AddWash door. It may break.
- Do not leave the AddWash door open while the machine is operating.
- Do not put heavy objects on the AddWash door at any time.
- To prevent physical injury, do not touch the AddWash door while the drum is rotating.
- Do not open the AddWash door while the machine is operating. This may cause physical injury.

- Do not manipulate the feature panel while the AddWash door is open. This may cause physical injury or system failure.
- Do not input objects other than laundry.
- Do not input bulky items to the drum through the AddWash door.
- Do not pull out the rubber packing of the AddWash door when cleaning. This may cause damage.

Mesh filter

Clean the mesh filter of the water hose once or twice a year.

1. Turn off the washing machine, and unplug the power cord.
2. Close the water tap.
3. Loosen and disconnect the water hose from the back of the washing machine. Cover the hose with a cloth to prevent water from gushing out.

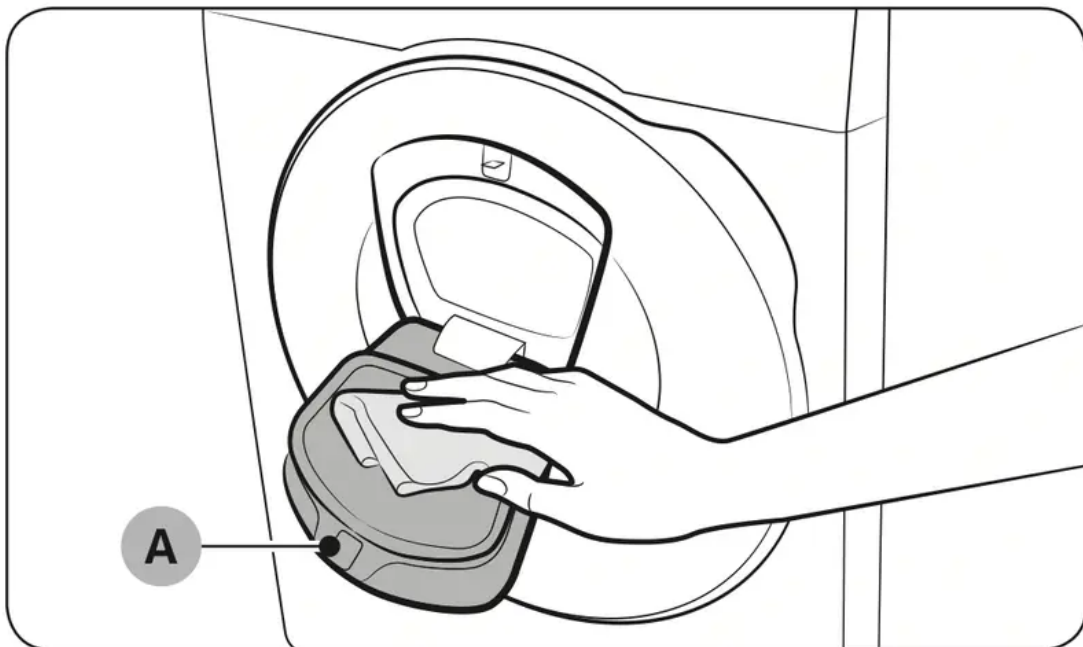

4. Use pliers to pull out the mesh filter from the inlet valve.
5. Submerge the mesh filter deeply in water so that the threaded connector is also submerged.
6. Dry the mesh filter completely in the shade.
7. Reinsert the mesh filter into the inlet valve, and reconnect the water hose to the inlet valve.

8. Open the water tap.

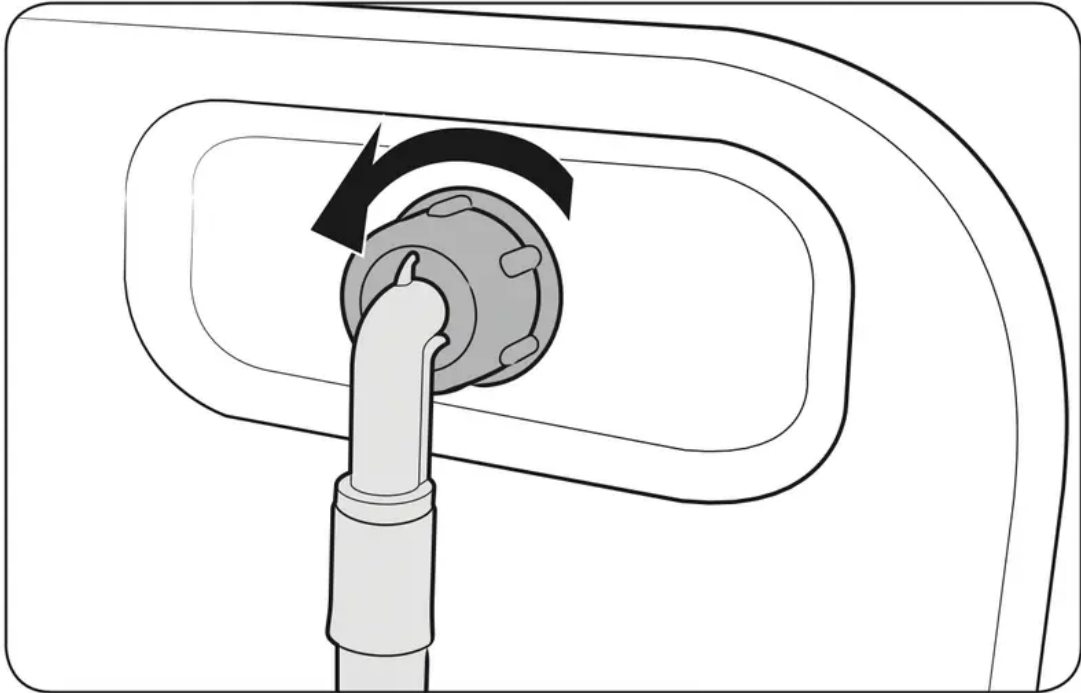

NOTE: If the mesh filter is clogged, an information code of “Check water supply” appears on the screen.

Debris filter

It is advisable to clean the debris filter every 2 months to prevent its clogging. A clogged debris filter may reduce the bubble effect.

1. Turn off the washing machine, and unplug the power cord.
2. Drain the remaining water inside the drum. See the Emergency drain section.
3. Gently press the top area of the filter cover to open.
4. Turn the debris filter knob to the left, and drain off the remaining water.

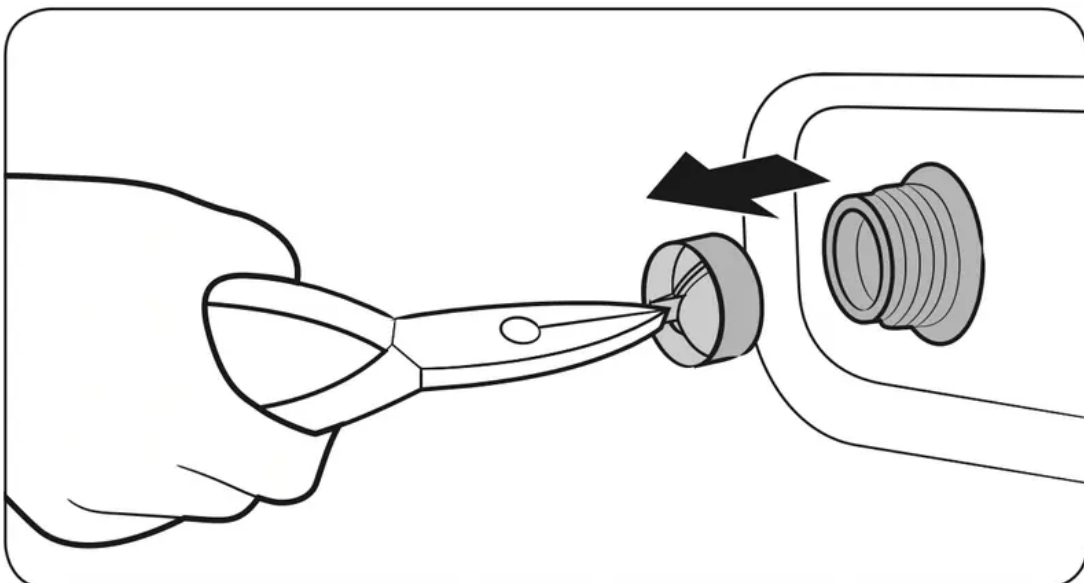

5. Clean the debris filter using soft brushes. Make sure the drain pump propeller inside the filter is unclogged.
6. Reinsert the debris filter, and turn the filter knob to the right.

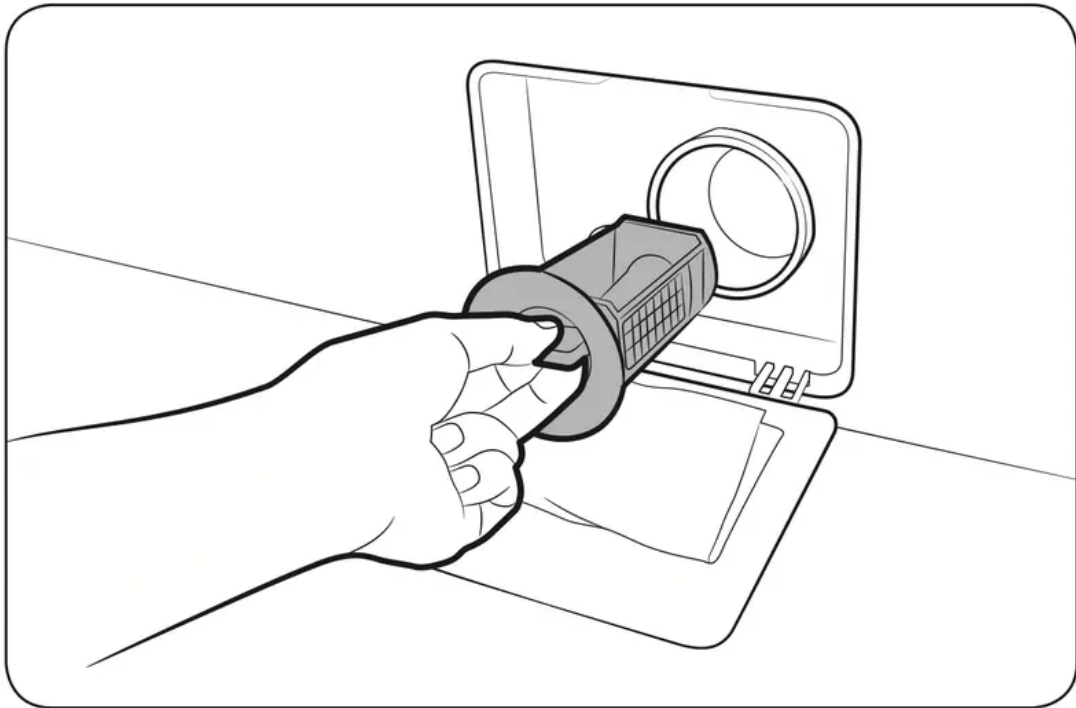

NOTE

- Some debris filters feature a safety knob that is designed to prevent accidents by children. To open the safety knob of the debris filter, push in and turn it anticlockwise. The spring mechanism of the safety knob helps open the filter.
- To close the safety knob of the debris filter, turn it clockwise. The spring makes a rattling sound, which is normal.

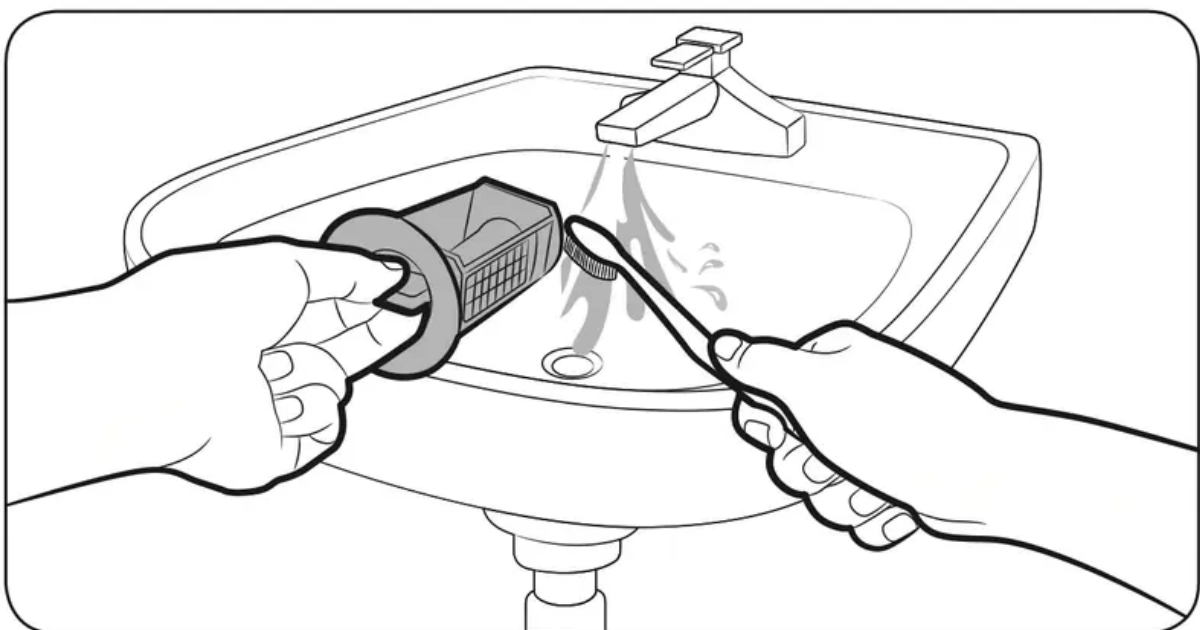

NOTE: If the pump filter is clogged, an information code of “Check drainage” appears on the screen.

CAUTION

- Make sure the filter knob is closed properly after cleaning the filter. Otherwise, this may cause a leak.
- Make sure the filter is inserted properly after cleaning it. Otherwise, this may cause an operational failure or a leak.

Detergent drawer

1. While holding down the release lever inside the drawer, slide open the drawer.

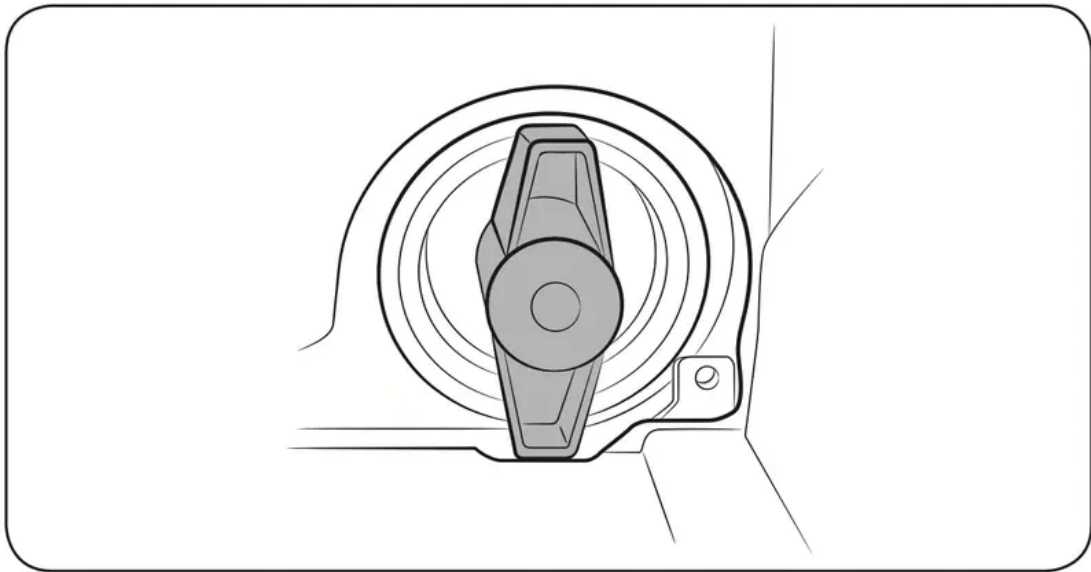

2. Clean the drawer components in flowing water using a soft brush.

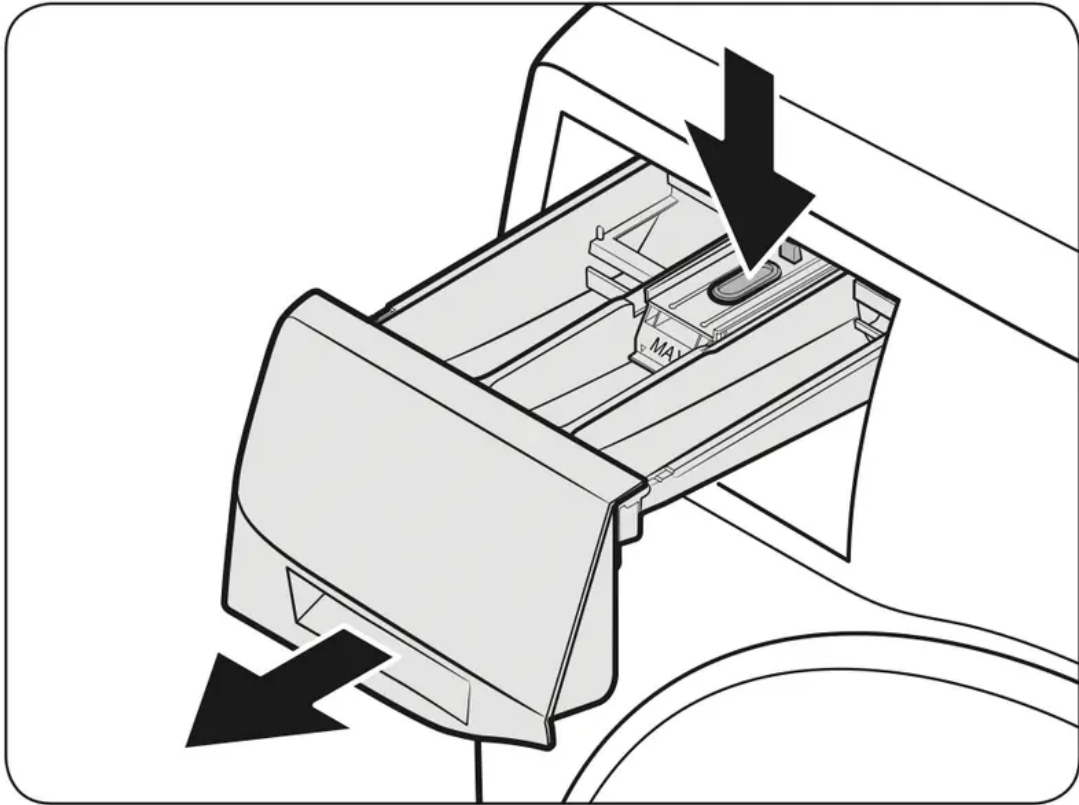

3. Clean the drawer recess using a soft brush.

4. Reinsert the liquid detergent container to the drawer.

5. Slide the drawer inward to close it.

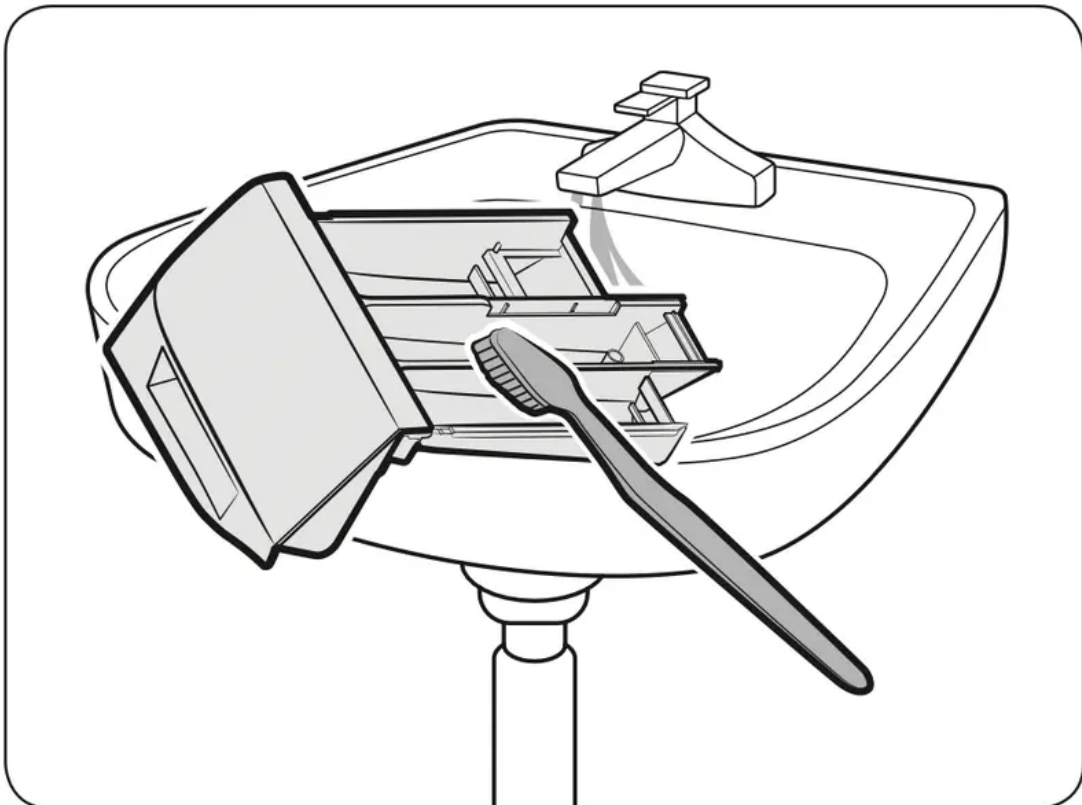

NOTE: Make sure the drawer recess is completely dry before inserting the detergent drawer.

NOTE: To remove remaining detergent, perform the Rinse+Spin cycle with the drum being empty.

Defrosting your washing machine

The washing machine may freeze when it drops below 0 °C.

1. Turn off the washing machine, and unplug the power cord.
2. Pour warm water over the water tap to loosen the water hose.
3. Disconnect the water hose, and soak it in warm water.
4. Pour warm water into the drum and leave it for about 10 minutes.
5. Reconnect the water hose to the water tap.

NOTE: If the washing machine still doesn't operate normally, repeat the above steps until it operates normally.

Care against an extended time of disuse

Avoid leaving the washing machine unused for an extended time. If this is the case, drain the washing machine and unplug the power cord.

1. Turn the Navigation dial to select Rinse+Spin.
2. Empty the drum, and then tap and hold .
3. When the cycle is complete, close the water tap and disconnect the water hose.
4. Turn off the washing machine, and unplug the power cord.
5. Open the door to let air circulate through the drum.





Troubleshooting

If there is any problem, check the information message on the LCD screen and follow the on-screen instructions.

If the problem persists, please contact the service center.

Checkpoints

If you encounter a problem with the washing machine, first check the table below and try these suggestions.

Problem	Action
<p>Does not start.</p>	<ul style="list-style-type: none"> • Make sure the washing machine is plugged in. • Make sure the door is properly closed. • Make sure the water taps are open. • Tap and hold  to start the washing machine. • Make sure Child Lock is not activated. • Before the washing machine starts to fill, it will make a series of clicking noises to check the door lock and will do quick drain. • Check the fuse or reset the circuit breaker. • Check if power is supplied properly. • Low voltage detected. <ul style="list-style-type: none"> ◦ Check if the power cord is plugged in. • Make sure laundry is not caught in the door. • The “DDC” message appears when you open the AddWash door without tapping and holding . If this happens, do one of the following: <ul style="list-style-type: none"> • Press the AddWash door to close properly. Then, tap and hold  and try again. • To add laundry, open the AddWash door and put in laundry. close the AddWash door completely. Then, tap and hold  to resume operation.
<p>Water supply is insufficient, or no water is supplied.</p>	<ul style="list-style-type: none"> • Fully open the water tap. • Make sure the door is properly closed. • Make sure the water supply hose is not frozen. • Make sure the water supply hose is not kinked or clogged. • Make sure there is sufficient water pressure. • Make sure that the cold water tap and the hot water tap are properly connected. • Clean the mesh filter as it may be clogged.

Problem	Action
<p>After a cycle, detergent remains in the detergent drawer.</p>	<ul style="list-style-type: none"> • Make sure the washing machine is running with sufficient water pressure. • Make sure the detergent is added to the centre of the detergent drawer. • Make sure the rinse cap is inserted properly. • If using granular detergent, make sure the detergent selector is in the upper position. • Remove the rinse cap and clean the detergent drawer.
<p>Excessive vibrations or makes noise.</p>	<ul style="list-style-type: none"> • Make sure the washing machine is installed on a level, solid floor that is not slippery. If the floor is not level, use the levelling feet to adjust the height of the washing machine. • Make sure the shipping bolts are removed. • Make sure the washing machine is not in contact with any other object. • Make sure the laundry load is balanced. • The motor can cause noise during normal operation. • Overalls or clothes with metallic decorations can cause noise while being washed. This is normal. • Metal objects such as coins can cause noise. After washing, remove these objects from the drum or filter case. • Redistribute the load. If only one item of clothing needs washing, such as a bathrobe or pair of jeans, the final spin result might be unsatisfactory, and a “Ub” check message will be shown in the display.
<p>Does not drain and/or spin.</p>	<ul style="list-style-type: none"> • Make sure the drain hose is straightened all the way to the drain system. If you encounter a drain problem, call for service. • Make sure the debris filter is not clogged. • Close the door and tap and hold  . For your safety, the washing machine will not tumble or spin unless the door is closed. • Make sure the drain hose is not frozen or clogged.

Problem	Action
	<ul style="list-style-type: none"> • Make sure the drain hose is connected to a drain system that is not clogged. • If the washing machine is not supplied with sufficient power, the washing machine will temporarily not drain or spin. As soon as the washing machine regains sufficient power, it will operate normally. • Make sure the drain hose is positioned correctly, depending on the connection type. • Clean the debris filter as it may be clogged.
<p>The door does not open.</p>	<ul style="list-style-type: none"> • Tap and hold  to stop the washing machine. • It may take a few moments for the door lock mechanism to disengage. • The door will not open until 3 minutes after the washing machine has stopped or the power has been off. • Make sure all the water in the drum is drained. • The door may not open if water remains in the drum. Drain the drum and open the door manually. • Make sure the door lock light is off. The door lock light turns off after the washing machine has drained.
<p>Excessive suds.</p>	<ul style="list-style-type: none"> • Make sure you use the recommended types of detergent as appropriate. • Use high efficiency (HE) detergent to prevent oversudsing. • Reduce the detergent amount for soft water, small loads, or lightly soiled loads. • Non-HE detergent is not recommended.
<p>Cannot add additional detergent.</p>	<ul style="list-style-type: none"> • Make sure the remaining amount of detergent and fabric softener is not over the limit.
<p>Stops.</p>	<ul style="list-style-type: none"> • Plug the power cord into a live electrical outlet. • Check the fuse or reset the circuit breaker.

Problem	Action
	<ul style="list-style-type: none"> • Close the door, and tap and hold  to start the washing machine. For your safety, the washing machine will not tumble or spin unless the door is closed. • Before the washing machine starts to fill, it will make a series of clicking noises to check the door lock and will do quick drain. • There may be a pause or soak period in the cycle. Wait briefly, and the washing machine may start. • Make sure the mesh filter of the water supply hose at the water taps is not clogged. Periodically clean the mesh filter. • If the washing machine is not supplied with sufficient power, the washing machine will temporarily not drain or spin. As soon as the washing machine regains sufficient power, it will operate normally.
<p>Fills with the wrong water temperature.</p>	<ul style="list-style-type: none"> • Fully open both taps. • Make sure the temperature selection is correct. • Make sure the hoses are connected to the correct taps. Flush water lines. • Make sure the water heater is set to supply a minimum of 49 °C hot water at the tap. Also, check the water heater capacity and recovery rate. • Disconnect the hoses and clean the mesh filter. The mesh filter may be clogged. • While the washing machine fills, the water temperature may change as the automatic temperature control feature checks incoming water temperature. This is normal. • While the washing machine fills, you may notice just hot and/or just cold water going through the dispenser when cold or warm temperatures are selected. This is a normal function of the automatic temperature control feature as the washing machine determines the water temperature.
<p>Load is wet at the end of a cycle.</p>	<ul style="list-style-type: none"> • Use the High or Extra High spin speed. • Use high efficiency (HE) detergent to reduce oversudsing.

Problem	Action
	<ul style="list-style-type: none"> • Load is too small. Small loads (one or two items) may become unbalanced and not spin completely. • Make sure the drain hose is not kinked or clogged.
Leaks water.	<ul style="list-style-type: none"> • Make sure the door is properly closed. • Make sure all hose connections are tight. • Make sure the end of the drain hose is correctly inserted and secured to the drain system. • Avoid overloading. • Use high efficiency (HE) detergent to prevent oversudsing. • Check the drain hose. <ul style="list-style-type: none"> ◦ Make sure the end of the drain hose is not placed on the floor. ◦ Make sure the drain hose is not clogged.
Has odours.	<ul style="list-style-type: none"> • Excessive suds collect in recesses and can cause foul odours. • Run cleansing cycles to sanitise periodically. • Clean the door seal (diaphragm). • Dry the washing machine interior after a cycle has finished.
No bubbles are seen (Bubble models only).	<ul style="list-style-type: none"> • You may not be able to see bubbles if there is too much items in the drum. • Severely contaminated laundry may not generate bubbles.
Can I open the AddWash door at any time?	<ul style="list-style-type: none"> • The AddWash door can be opened only when the  indicator appears. However, it does not open in the following cases: <ul style="list-style-type: none"> ◦ When the boiling or drying process is running and the internal temperature becomes high ◦ If you set the Child Lock for safety reasons ◦ When the drum wash or drum drying cycle that does not involve additional laundry is running.

Problem	Action
<p>A message appears on the display to alert that dispenser is open.</p>	<ul style="list-style-type: none"> • Check if the detergent drawer is closed properly. <ul style="list-style-type: none"> ◦ Open the detergent drawer and close it again. Make sure it's closed properly.

If a problem persists, contact a service center. The number of the service center is on the label attached to the product.

Information codes

If the washing machine fails to operate, you may see an information code on the screen. Check the table below and try the suggestions.



Code	Action
Check drainage	<p>Water is not draining.</p> <ul style="list-style-type: none"> • Make sure the drain hose is not frozen or clogged. • Make sure the drain hose is positioned correctly, depending on the connection type. • Clean the debris filter as it may be clogged. • Make sure the drain hose is straightened all the way to the drain system. • If the information code remains, contact a customer service centre
Check water supply	<p>Water is not supplied.</p> <ul style="list-style-type: none"> • Make sure the water taps are open. • Make sure the water hoses are not clogged. • Make sure the water taps are not frozen. • Make sure the washing machine is operating with sufficient water pressure. • Make sure that the cold water tap and the hot water tap are properly connected. • Clean the mesh filter as it may be clogged. • All buttons will be disabled for 3 minutes after the information code appears. • When the "Check water supply" message appears, the machine drains water for 3 minutes. In the meantime, the Power button will be disabled.
Check water lines	<ul style="list-style-type: none"> • Make sure the cold water supply hose is firmly connected to the cold water tap. If it is connected to the hot water tap, the laundry may be deformed with some cycles.
Unbalanced laundry detected	<p>Spinning does not work.</p> <ul style="list-style-type: none"> • Make sure laundry is spread out evenly. • Make sure the washing machine is on a flat, stable surface. • Redistribute the load. If only one item of clothing needs washing, such as a bathrobe or pair of jeans, the final spin



Code	Action
	<p>result might be unsatisfactory, and an “Unbalanced laundry detected” check message will be shown in the display.</p>
Door is open	<p>Operating the washing machine with the door open.</p> <ul style="list-style-type: none"> • Make sure the door is properly closed. • Make sure laundry is not caught in the door.
Addwash door is open (applicable models only)	<p>This message appears when you open the Add Door without pressing Start/ Pause (Hold to Start). If this happens, do one of the following:</p> <ul style="list-style-type: none"> • Press the Add Door to close properly. Then, press and hold Start/Pause (Hold to Start) and try again. • To add laundry, open the Add Door and input laundry. Close the Add Door properly. Then, press and hold Start/Pause (Hold to Start) to resume operation.
OC	<p>Water has overflowed.</p> <ul style="list-style-type: none"> • Restart after spinning. • If the information code remains on the display, contact a local Samsung service centre.
LC, LC1	<p>Check the drain hose.</p> <ul style="list-style-type: none"> • Make sure the end of the drain hose is not placed on the floor. • Make sure the drain hose is not clogged. • If the information code remains, contact a customer service centre.
3C	<p>Check the drum motor for operation.</p> <ul style="list-style-type: none"> • Try restarting the cycle. • If the information code remains, contact a customer service centre.
3CP	<p>The electronic control needs to be checked.</p> <ul style="list-style-type: none"> • Try restarting the cycle.

Code	Action
	<ul style="list-style-type: none"> • If the information code remains, contact a customer service centre.
UC	<p>Check the pulsator motor for operation.</p> <ul style="list-style-type: none"> • Check if power is supplied properly. • If the information code remains, contact a customer service centre.
	<p>Low voltage detected.</p> <ul style="list-style-type: none"> • Check if the power cord is plugged in. • If the information code remains, contact a customer service centre.
HC	<p>High temperature heating check.</p> <ul style="list-style-type: none"> • If the information code remains, contact a customer service centre.
1C	<p>The Water Level sensor is not working properly.</p> <ul style="list-style-type: none"> • Turn the machine off, and restart the cycle. • If the information code remains, contact a customer service centre.
AC	<p>Check communications between main and sub PBAs.</p> <ul style="list-style-type: none"> • Turn the machine off, and restart the cycle. • If the information code remains, contact a customer service centre.
8C	<p>The MEMS sensor is not working properly.</p> <ul style="list-style-type: none"> • Turn the machine off, and restart the cycle. • If the information code remains, contact a customer service centre.



Code	Action
AC6	<p>Check communications between the main and the inverter PBAs.</p> <ul style="list-style-type: none"> • Depending on the state, the machine may automatically returns to normal operation. • Turn the machine off, and restart the cycle. • If the information code remains, contact a customer service centre.
DC1	<p>The Main Door lock/unlock is not working properly.</p> <ul style="list-style-type: none"> • Turn the machine off, and restart the cycle. • If the information code remains, contact a customer service centre.
DC3	<p>The Add Door lock/unlock is not working properly.</p> <ul style="list-style-type: none"> • Turn the machine off, and restart the cycle. • If the information code remains, contact a customer service centre.

Warning

This content is compiled from multiple sources and is provided for reference purposes only. It may not be complete or fully applicable to all situations. If you are unable to resolve your issue, please contact the product manufacturer or an authorized service provider for official support.

