

USING THE REFRIGERATOR

Controls (on some models)

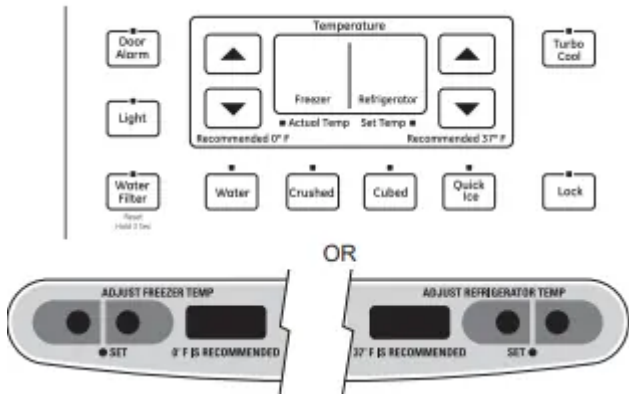

The temperature controls are preset in the factory at 37°F (2.8°C) for the refrigerator compartment and 0°F (-17.8°C) for the freezer compartment. Allow 24 hours for the temperature to stabilize to the preset recommended settings.

The temperature controls can display both the SET temperature as well as the actual temperature in the refrigerator and freezer. The actual temperature may vary slightly from the SET temperature based on usage and operating environment.

On some models, setting both controls to the warmest setting until the display flashes (off) will stop cooling in both the freezer and refrigerator compartments.

On other models, setting either control to the warmest setting until the display flashes (off) will stop the cooling to the freezer and refrigerator.

NOTE: Turning the refrigerator off via the controls on the touch panel does not shut off electrical power to the refrigerator.

NOTE: The refrigerator is shipped with protective film- covering the temperature controls. If this film was not removed during installation, remove it now.

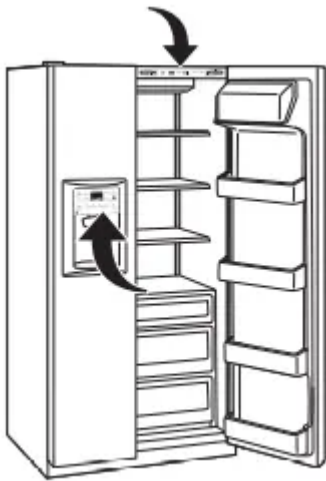

Performance Air Flow System

The Performance Air-Flow System is designed to maximize temperature control in the refrigerator and freezer compartments. This unique special feature consists of the Air Tower along the back wall of the refrigerator and the Air Tunnel on the bottom portion of the freezer rear wall.

Placing food in front of the louvers on these components will not affect performance. Although the Air Tower and the Air Tunnel can be removed, doing so will affect temperature performance. (For removal instructions, on-line, 24 hours a day, contact us at

GEAppliances.com or call 800.GE.CARES. In Canada, contact us at geappliances.ca or call 1.800.561.3344.)

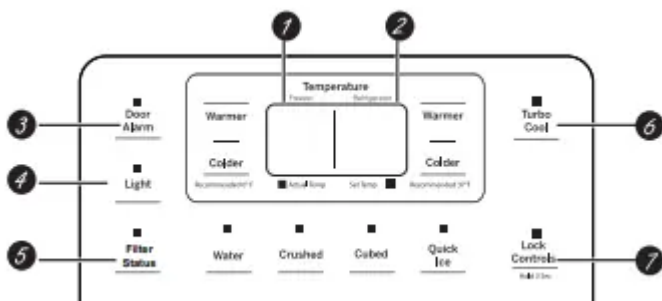

The temperature controls can display both the SET temperature as well as the actual temperature in the refrigerator and freezer. The actual temperature may vary slightly from the SET temperature based on usage and operating environment.

1 Freezer Compartment Temperature Control

Adjust freezer compartment temperature. The freezer temperature is preset in the factory at 0°F (-17.8°C). Allow 24 hours for temperature to stabilize to the preset recommended setting.

2 Fresh Food Compartment Temperature Control

Adjust fresh food compartment temperature. The fresh food temperature is preset in the factory at 37°F (2.8°C). Allow 24 hours for temperature to stabilize to the preset recommended setting.

3 Door Alarm (on some models)

To set the alarm, press this pad until the indicator light comes on. This alarm will sound if either door is open for more than 3 minutes. The light goes out and the beeping stops when you close the door.

4 LED dispenser Light

Press the Light pad to turn your dispenser light on and off.

5 Filter Status

Press the Filter Status pad to display the water filter's life percentage (%).

The temperature controls are preset in the factory at 37°F (2.8°C) for the refrigerator compartment and 0°F (-17.8°C) for the freezer compartment. Allow 24 hours for the temperature to stabilize to the preset recommended settings.

6 TurboCool™ (on some models)

TurboCool™ rapidly cools the refrigerator compartment in order to more quickly cool foods. Use TurboCool™ when adding a large amount of food to the refrigerator compartment, putting away foods after they have been sitting out at room temperature or when putting away warm leftovers. It can also be used if the refrigerator has been without power for an extended period.

NOTES: The refrigerator temperature cannot be changed during TurboCool™.

The freezer temperature is not affected during TurboCool™.

When opening the refrigerator door during TurboCool™, the fans will continue to run if they have cycled on.

7 Lock Controls

Press and hold the Lock Controls pad for 3 seconds to lock out ice and water dispenser and all other controls. Press and hold to unlock the controls.

COMPRESSOR

To turn off compressor:

1. Raise the freezer temperature above the highest setting by pressing the Freezer warmer pad until the display starts blinking.
2. Raise the Fresh Food temperature above the highest setting until you see OFF.

To turn on the compressor:

1. Press Fresh Food or Freezer colder pad.

NOTE: Compartment lights and the user interface display will stay on.

ClimateKeeper2™ (on some models.)

How it Works

The ClimateKeeper2™ is the industry's most advanced refrigeration system, delivering optimum temperature and humidity performance to keep food garden fresh longer and reduce freezer burn.

The ClimateKeeper2™ system features two evaporators—one for the refrigerator and one for the freezer.

This provides two separate cooling systems, and separates the airflow between the fresh food and freezer compartments during normal cooling operations."



This ensures that the humidity levels in the fresh food compartment are significantly higher than in a conventional system,** allowing fresh produce and other unsealed foods to retain their moisture content and freshness longer.

Moisture sensitive foods such as fresh fruit, salads, rice, etc., can now be stored on open shelves without excessive moisture loss.

Due to the higher humidity in the refrigerator, you may on occasion experience fog or small amounts of moisture in the refrigerator compartment. This is normal and may come and go as different food loads and environmental conditions change. Wipe dry with a paper towel if desired.

The separate airflow system minimizes the mixing of air between the two compartments, which reduces fresh food odor transfer to improve the taste of ice.

The ClimateKeeper2™ system also reduces the number of defrosting cycles in the freezer evaporator, thereby reducing freezer burn.

Freezer air is used in the CustomCool™ feature.

Testing shows a higher level of humidity in the Fresh Food section in Climate Keeper2™ refrigerators versus conventional units.

TurboCool™ (on some models.)

How it Works

TurboCool™ rapidly cools the refrigerator compartment in order to more quickly cool foods. Use TurboCool™ when adding a large amount of food to the refrigerator compartment, putting away foods after they have been sitting out at room temperature or when putting away warm leftovers. It can also be used if the refrigerator has been without power for an extended period.

Once activated, the compressor will turn on immediately and the fans will cycle on and off at high speed as needed for eight hours. The compressor will continue to run until the refrigerator compartment cools to approximately 34°F (1°C), then it will cycle on and off to maintain this setting. After 8 hours, or if TurboCool™ is pressed again, the refrigerator compartment will return to the original setting.

How to Use

Press TurboCool™. The TurboCool™ temperature display will show Tc and the LED will be activated.

After TurboCool™ is complete, the TurboCool™ indicator light will go out.

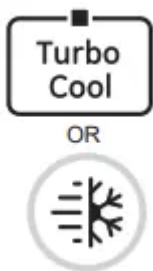

NOTES: The refrigerator temperature cannot be changed during TurboCool™

The freezer temperature is not affected during TurboCool™,

When opening the refrigerator door during TurboCool™, the fans will continue to run if they have cycled on.

ExpressChill™ (on some models)

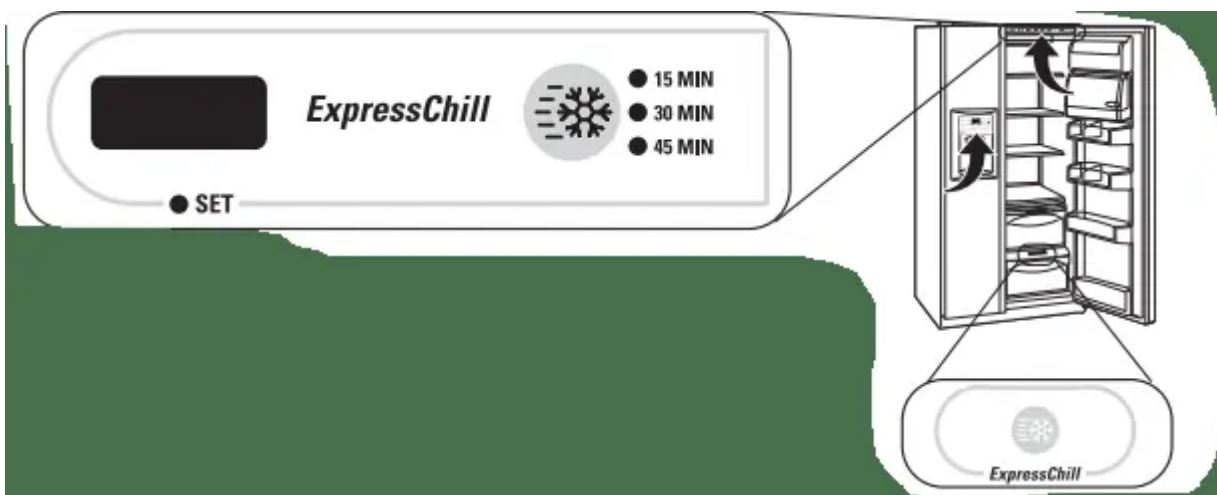

How it Works

The ExpressChill™ feature is a system of dampers, a fan and a temperature thermistor.

The pan is tightly sealed to prevent the pan's temperature from causing temperature fluctuations in the rest of the refrigerator.

The controls for this pan are located in the top of the refrigerator or on the dispenser with the temperature controls.

How to Use

Empty the pan. Place the Chill Tray in the pan. Place the items on the tray and close the pan completely.

Select the ExpressChill™ pad. On some models, you can then select the chill time (use chart to determine best setting). Other models will only have one option (45 minutes). On models with multiple settings, tap the pad until the light appears next to the desired setting.

- To stop a feature before it is finished, tap that feature's pad until no options are selected and the display is off.
- During ExpressChill™, the display on the controls will count down the time in the cycle.

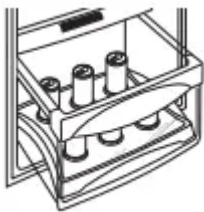

ExpressChill™

How to Remove and Replace the Drawer

To remove:

1. Pull the drawer out to the stop position.
2. Rotate all four swing locks to the unlock position.
3. Lift the front of the drawer up and out.

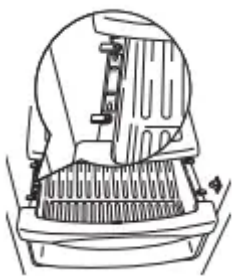

To replace:

1. Make sure all four swing locks are in the unlock position.
2. Place the sides of the drawer into the drawer supports, making sure the swing locks fit on the drawer slots.
3. Lock all four swing locks by rotating them to the lock position.

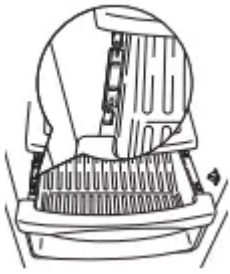

Express Chill™ Chart (on some models)

NOTE: Results may vary depending on packaging, starting temperature and other food traits.

15 Minutes

- 1 Beverage Can (12 oz)
- 2 Small Juice Boxes (6-8 oz each)

30 Minutes

- 2 to 6 Beverage Cans (12 oz each)
- 2 Plastic 20 oz Bottles of Beverage
- 4 to 6 Small Juice Boxes (6-8 oz each)
- 3 Foil Juice Packets
- Wine (750 ml bottle)

45 Minutes

- 2 Liters of Beverage
- 1/2 Gallon of Juice
- Gelatin-1 package



Water Filter Cartridge - MWF (On some models.)

Water filter cartridge

The water filter cartridge is located in the back upper right corner of the refrigerator compartment.

When to replace the filter on models with a replacement indicator light

There is a replacement indicator light for the water filter cartridge on the dispenser. This light will turn orange to tell you that you need to replace the filter soon.

The filter cartridge should be replaced when the replacement indicator light turns red or if the flow of water to the dispenser or icemaker decreases.

When to replace the filter on models without a replacement indicator light

The filter cartridge should be replaced every six months or earlier if the flow of water to the dispenser or icemaker decreases.

Removing the filter cartridge

If you are replacing the cartridge, first remove the old one by slowly turning it to the left. Do not pull down on the cartridge. A small amount of water may drip down.

Installing the filter cartridge

1. If you are replacing a SmartWater™ cartridge with an adapter, it must be removed before installing the cartridge. To remove the adapter, turn it to the left about 1/4 turn.

If you are replacing a Water by Culligan cartridge, leave the adapter in place. This adapter will stay in the refrigerator when you replace future cartridges.

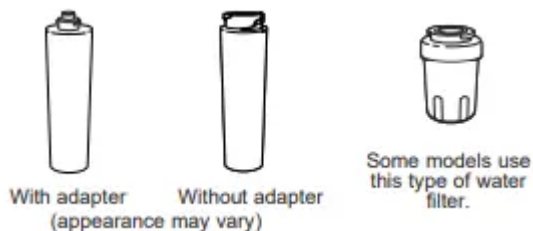

2. On models without a replacement indicator light, apply the month and year sticker to the new cartridge to remind you to replace the filter in six months.

3. Fill the replacement cartridge with water from the tap to allow for better flow from the dispenser immediately after installation.

4. Line up the arrow on the cartridge and the cartridge holder. Place the top of the new cartridge up inside the holder. Do not push it up into the holder.



5. Slowly turn it to the right until the filter cartridge stops. DO NOT OVERTIGHTEN. As you turn the cartridge, it will automatically raise itself into position. The cartridge will move about 1/2 turn.

6. Run water from the dispenser 1-1/2 gallons (about three minutes) to clear the system and prevent sputtering.

7. Press and hold the WATER FILTER pad (on some models) on the dispenser for 3 seconds.



NOTE: A newly-installed water filter cartridge may cause water to spurt from the dispenser upon first use.

Filter bypass plug

You must use the filter bypass plug when a replacement filter cartridge is not available. The dispenser and the icemaker will not operate without the filter or filter bypass plug.

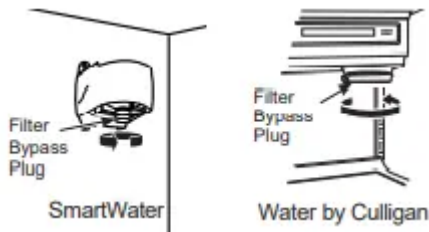

To use the filter bypass plug on Water by Culligan™ models, you must first remove the filter adapter from the cartridge holder by turning it to the left.

For the maximum benefit of your filtration system, GE Appliances recommends the use of GE Appliances branded SmartWater™ filters only. Using GE Appliances branded filters in GE Appliances and Hotpoint refrigerators provides optimal performance and reliability. GE Appliances branded SmartWater™ filters are always the right choice because they are patented and designed specifically for GE Appliances products. SmartWater™ filters meet rigorous industry NSF standards for safety and quality that are important for products that are filtering your water. GE Appliances has not qualified non-GE Appliances branded filters for use in GE Appliances and Hotpoint refrigerators and there is no assurance that non-GE Appliances branded filters meet GE Appliances standards for quality, performance and reliability.

To obtain a bypass plug or if you have questions-visit our

Website at GEAppliances.com, or call 1.800.GE. CARES (1.800.432.2737).

Replacement filters:

If you have questions, or to order additional filter cartridges, visit our website at gewaterfilters.com or call GE Appliances Parts and Accessories,

In Canada, call 800.661.1616.

Water Filter Cartridge - XWFE (On some models)

Water Filter Cartridge

The water filter cartridge holder is located in the back upper-right corner of the fresh food refrigerator compartment.

Select models use radio frequency identification (RFID) to detect leaks and monitor filter status. The RFID technology is certified by the FCC.

Contains

FCC ID: ZKJ-294D2018 IC: 10229A-294D2018

This device complies with part 15 of the FCC Rules.

Operation is subject to the following two conditions:

This device may not cause harmful interference, and this device must accept any interference received, including interference that may cause undesired operation."

This device complies with Industry Canada licence- exempt RSS standard(s). Operation is subject to the following two conditions:

- (1) this device may not cause interference, and
- (2) this device must accept any interference, including interference that may cause undesired operation of the device."

When to Replace the Filter

If there is a replacement indicator light for the water filter cartridge on the dispenser, a red light will start blinking to tell you that you need to replace the filter soon. For models that don't have the indicator light, the filter cartridge should be replaced every six months, or earlier if the flow of water to the dispenser or icemaker decreases.

Removing the Filter

If you are replacing the filter, first remove the previous one by gently grasping the filter and slowly turning it to the left, about a 90° turn. The filter should automatically release itself when you have rotated it far enough to the left. A small amount of water may drip down.

CAUTION

If air has been trapped in the system, the filter cartridge may be ejected as it is removed. Use caution when removing.

Filter Bypass Plug

To reduce the risk of property damage due to water leakage, you **MUST** use the filter bypass plug when a replacement filter cartridge is not available. Some models do not come equipped with the filter bypass plug. To obtain a free bypass plug, call 800-GECARES. In Canada, call 800.561.3344. The dispenser and icemaker will not operate without either the filter or bypass plug installed. The bypass plug is installed in the same way as a filter cartridge.

Installing the Filter Cartridge in a Side by Side Refrigerator

1. Line up the arrow on the filter with the arrow on the filter cartridge holder. Gently push the top of the new filter up inside the holder.

2. Slowly turn the filter to the right until it stops. DO NOT OVERTIGHTEN. As you turn the filter, it will automatically raise itself into position. The filter will move about a 1/4 turn or 90 degrees.
3. Run water from the dispenser for 2 gallons (7.6 liters) or approximately 5 minutes to clear the system. Water may spurt out and air bubbles may be visible during this process.
4. Press and hold the RESET WATER FILTER button on the dispenser for 3 seconds. On select models, filter reset will be automatic when a new filter is installed.

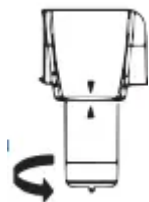

Application Guidelines/Water Supply

| | |
|-------------------|----------------------------|
| Service Flow | 0.5 gpm (1.89 lpm) |
| Water Supply | Potable Water |
| Water Pressure | 25-120 psi (172-827 kPa) |
| Water Temperature | 33°F-100°F (0.6°C-38°C) |
| Capacity | 170 gallons (643.5 liters) |

Sign-up for TEXT REMINDERS by texting REPLACE to 70543.

Shelves and Bins

Not all features are on all models.

Refrigerator Door Bins and Freezer Door Tilt-Out Bins

Large Bins

The larger refrigerator door bins and freezer tilt-out door bins are adjustable.

To remove: Lift the front of the bin straight up, then lift up and out.

To replace or relocate: Engage the back side of the bin in the molded supports of the door. Then push down on the front of the bin. Bin will lock in place.

Small Bins

To remove: Lift the front of the bin straight up then out.

To replace: Position the bin above the rectangular molded supports on the door. Then slide the bin down onto the support to lock it in place.

The snugger helps prevent tipping, spilling or sliding of small items stored on the door shelf. Place a finger on either side of the snugger near the rear and move it back and forth to fit your needs.

NOTE: Be careful when placing items in the top bin. Make sure that items do not block or fall into the ice chute.

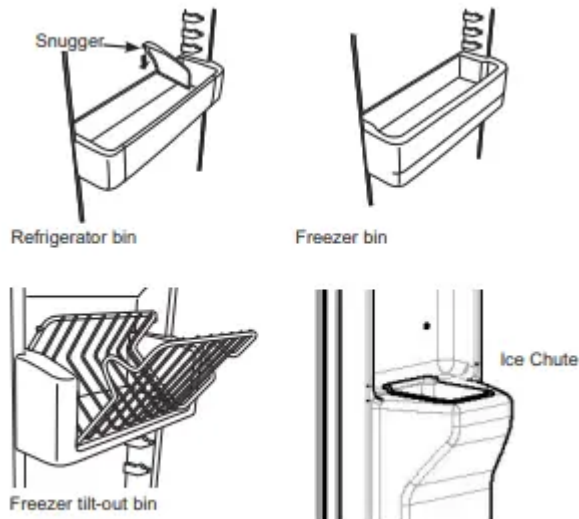

Slide-Out Shelf (on some models)

The slide-out shelf allows you to reach items stored behind others. The special edges of the spillproof shelf are designed to help prevent spills from dripping to lower shelves.

Spillproof Shelf

To remove: Slide the shelf out until it reaches the stop, then press down on the tab and slide the shelf straight out.

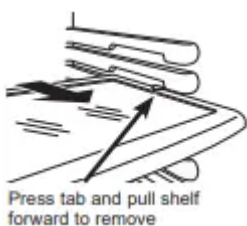

To replace or relocate: Line the shelf up with the supports and slide it into place. The shelf can be repositioned when the door is at 90° or more. To reposition the shelf, slide the shelf past the stops and angle downward. Slide shelf down to the desired position, line up with the supports and slide into place. Make sure you push the shelves all the way back in before you close the door.

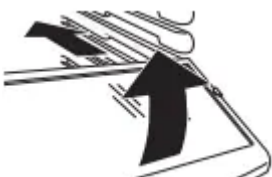

Edge-to-Edge Shelf

To remove: With door opened at an angle greater than 90°, slide the shelf out until it reaches the stop tab. Press down on the tab and slide the shelf out until it reaches the shelf's back trim. While keeping the left side of the shelf in contact with the cabinet, pull the shelf down and forward toward the left to remove.

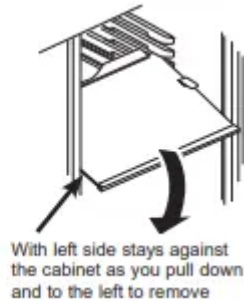
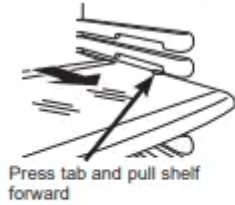

To replace or relocate: With door opened at an angle greater than 90°, align the shelves back trim against the shelf support. Keeping the left side against the cabinet, slowly lift and gently push the shelf back into place. Reposition the shelf past the stop tabs. Make sure you push the shelves all the way back in before you close the door.

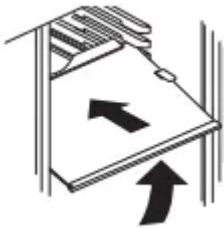

Freezer Baskets (on some models)

To remove, slide out to the stop position, lift the front past the stop position, and slide out.

Make sure you push the baskets all the way back in before you close the door.



Freezer Baskets (on some models)

To remove, push the basket all the way to the back of the freezer. Lift up until the back pins are disengaged. Lift the entire basket up and pull out.

Make sure you push the baskets all the way back in before you close the door.



QuickSpace™ Shelf (on some models)

This shelf splits in half and slides under itself for storage of tall items on the shelf below.

This shelf can be removed and replaced or relocated just like Slide-Out Spillproof Shelves.

On some models, this shelf can not be used in the lowest position.

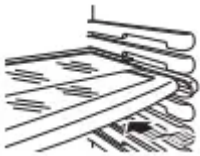

Slide-Out Freezer Shelves

To remove, slide out to the stop position, lift the front past the stop position, and slide out from rib.

Make sure you push the shelves all the way back in before you close the door.



Fixed Freezer Shelves

To remove, lift the shelf up at the left side and then bring the shelf out.

NOTE FOR DISPENSER MODELS: In order to take full advantage of the tilt-out ice bin (on some models), only store items on the shelf below the ice bin that are no taller than the lowest point on the bin.

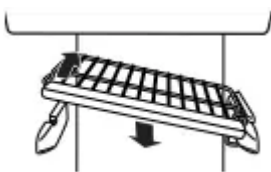

Door Wine/Beverage Rack (on some models)

This rack holds up to 5 cans, one bottle of wine or one 2-liter bottle of soda.

The rack hangs from the sides of the dairy bin.

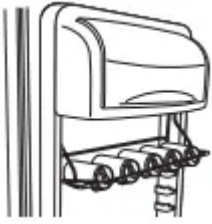

To remove:

1. Empty the wine/beverage rack.
2. Holding the bottom of the dairy bin, lift the front straight up, then lift up and out.
3. To detach the rack from the dairy bin, pull the rack's side wires out of the holes on each side of the dairy bin.



To replace:

1. Reattach the rack to the sides of the bin.
2. Engage the back side of the bin in the molded supports on the door. Then push down on the front of the bin. The bin will lock into place.

ShelfSaver™ Rack (on some models)

Use this rack to store beverage cans for easy access.

It can also hold a 9" x 13" baking dish.

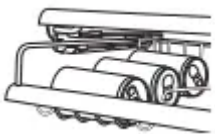

Door Can Rack (on some models)

This door rack holds up to 9 cans.

NOTE: This rack can only be mounted in the top position under the dairy bin.



Removable Beverage Rack (on some models)

The beverage rack is designed to hold a bottle on its side.

It can be attached to any slide-out shelf.

To install:

1. Line up the large part of the slots on the top of the rack with the tabs under the shelf.
2. Then slide the rack back to lock it in place.

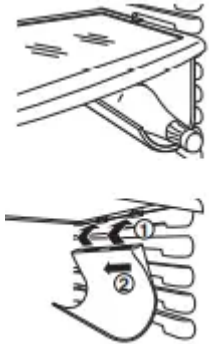

Refrigerator Doors

Refrigerator Doors (on some models)

The refrigerator doors may feel different than the ones you are used to. The special door opening/closing feature makes sure the doors close all the way and are securely sealed.

When opening and closing the door you will notice a stop position. If the door is opened past this stop point, the door will remain open to allow you to load and unload food more easily. When the door is only partially open, it will automatically close.

The resistance you feel at the stop position will be reduced as the door is loaded with food.

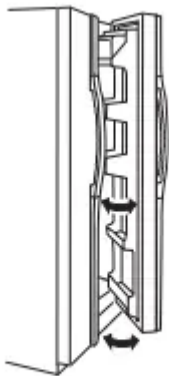

When the door is only partially open,
it will automatically close.
Beyond this stop the door will stay open.

Door Alignment

If doors are uneven, adjust the refrigerator door.

To remove the base grille, open the doors, remove the screw at each end of the base grille and then pull the grille straight out.

1. Using a 7/16" socket wrench, turn the door adjusting screw to the right to raise the door; to the left, to lower it. (A nylon plug, imbedded in the threads of the pin, prevents the pin from turning unless a wrench is used.)
2. After one or two turns of the wrench, open and close the refrigerator door and check the alignment at the top of the doors.

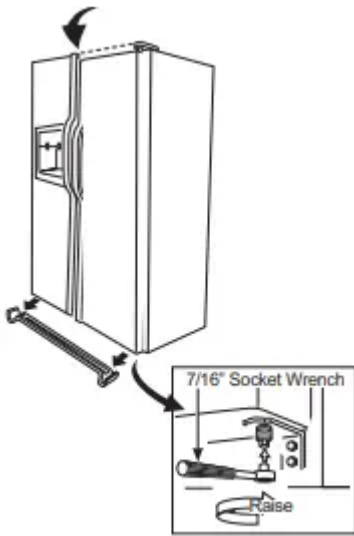

Crispers and Pans

Not all features are on all models.

Fruit and Vegetable Crispers

Excess water that may accumulate in the bottom of the drawers should be wiped dry.

On some models, the bottom drawer has full extension slides that allow full access to the drawer.



Adjustable Humidity Crispers

Slide the control all the way to the HI setting to provide high humidity recommended for most vegetables.

Slide the control all the way to the LO setting to provide lower humidity levels recommended for most fruits.



Crisper Removal

Crispers can easily be removed by pulling the drawer straight out and lifting the drawer up and over the stop location.

If the door prevents you from taking out the drawers, first try to remove the door bins. If this does not offer enough clearance, the refrigerator will need to be rolled forward until the door opens enough to slide the drawers out. In some cases, when you roll the refrigerator out, you will need to move the refrigerator to the left or right as you roll it out.

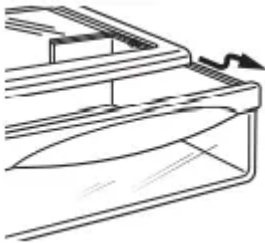

Convertible Deli Pan (on some models)

The convertible deli pan has its own cold air duct to allow a stream of cold air from the freezer compartment or refrigerator compartment to flow to the pan.

The variable temperature control regulates the air flow from the Climate Keeper.

Set the control to the coldest setting to store fresh meats.

Set the control to cold to convert the pan to normal refrigerator temperature and provide extra vegetable storage space. The cold air duct is turned off. Variable settings between these extremes can be selected.

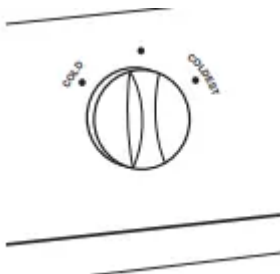

Automatic Icemaker

Not all features are on all models.

Automatic Icemaker

The icemaker will produce seven cubes per cycle- approximately 100-130 cubes in a 24-hour period, depending on freezer compartment temperature, room temperature, number of door openings and other use conditions.

If the refrigerator is operated before the water connection is made to the icemaker, set the power switch in the OFF position.

When the refrigerator has been connected to the water supply, set the power switch to the ON position.

The icemaker will fill with water when it cools to 15°F (-10°C). A newly installed refrigerator may take 12 to 24 hours to begin making ice cubes.

You will hear a buzzing sound each time the icemaker fills with water.

Throw away the first few batches of ice to allow the water line to clear.

Be sure nothing interferes with the sweep of the feeler arm.

When the bin fills to the level of the feeler arm, the icemaker will stop producing ice. It is normal for several cubes to be joined together.

If ice is not used frequently, old ice cubes will become cloudy, taste stale and shrink.

CAUTION

Avoid contact with the moving parts of the ejector mechanism, or with the heating element (located on the bottom of the ice maker) that releases the cubes. Do not place fingers or hands on the automatic ice making mechanism while the refrigerator is plugged in.

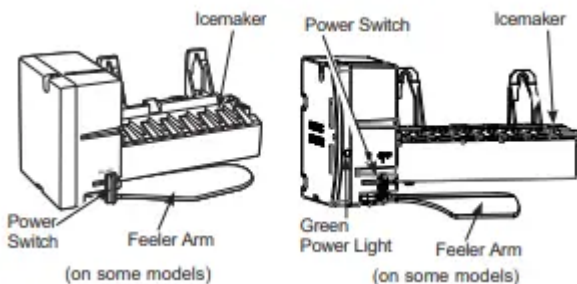

Special note about dispenser models:

- Some models have a tilt-out ice bin. The bin can be tilted out as shown in the illustrations, and it will hold itself up while you take ice out or turn the icemaker power switch on and off. Be sure to put the bin back in place before closing the door.
- To restore your ice level from an empty bucket stage, the following steps are recommended:

1. 12 hours after the first batch of ice has fallen into the bin, dispense 3 to 4 cubes.
2. After an additional 6 hours, dispense 3 to 4 cubes again.

These steps will restore your ice level in the shortest amount of time.

NOTE:

In homes with lower than average water pressure, you may hear the icemaker cycle multiple times when making one batch of ice.

Accessing Ice and Reaching the Power Switch on Dispenser Models

There are two types of ice storage bins on dispenser models. One has a shelf above the bin, the other does not.

Special note for models with tilt-out ice bin:

- These models have a tilt-out ice bin. The bin can be tilted out as shown in the illustrations, and it will hold itself up while you take ice out or turn the icemaker power switch on and off. Be sure to put the bin back in place before closing the door.

NOTE: In order to take full advantage of the tilt-out ice bin, only store items on the shelf below the ice bin that are no taller than the lowest point on the bin.

Models with tilt out ice bin

To access ice and reach the icemaker power switch:

1.



Lift the bin, then pull it forward until the bin stops.

2.



Lower the bin to access ice or reach the power switch.

Models with a shelf above the ice bin

To access ice, pull the bin forward.



To reach the power switch, pull the shelf straight out.

Always be sure to replace the shelf.

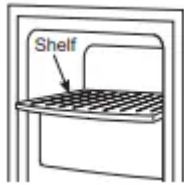

On some models, to access ice or reach the power switch:

1.

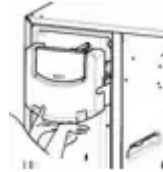

Pull the bin forward until the bin stops.

2.

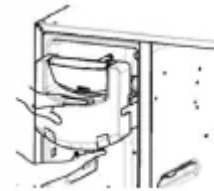

Lower the bin to access ice or reach the power switch.

Removing Ice Bin (dispenser models)

CAUTION

The ice bin is heavy when full.

Set the power switch to the OFF position before removing the bin.

When replacing the bin, be sure to press it firmly into place. If it does not go all the way back, remove it and rotate the drive mechanism 1/4 turn. Then push the bin back again.

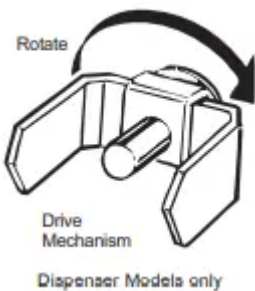

Ice and Water Dispenser (on some models.)

Using the Dispenser

Select CUBED ICE. 

CRUSHED ICE  or WATER 

Press the glass gently against the top of the dispenser cradle.

The spill shelf is not self- draining. To reduce water spotting, the shelf and its grille should be cleaned regularly.

If no water is dispensed when the refrigerator is first installed, there may be air in the water line system. Press the dispenser arm for at least two minutes to remove trapped air from the water line and to fill the water system. To flush out impurities in the water line, throw away the first six glassfuls of water.



CAUTION Laceration Hazard

- Never put fingers or any other object into ice crusher discharge opening. Doing so can result in contacting the ice crushing blades and lead to serious injury or amputation
- Use a sturdy glass when dispensing ice. A delicate glass may break and result in personal injury.



Locking the Dispenser

Press the LOCK pad for 3 seconds to lock the dispenser and control panel. To unlock, press and hold the pad again for 3 seconds.



Dispenser Light

This pad turns the light in the dispenser on and off. The light also comes on when the dispenser cradle is pressed. For models with a bulb, if the light burns out, it should be replaced with a 6 watt 12V maximum bulb. For LED models, contact Factory Service.



Quick Ice (on some models)

When you need ice in a hurry, press this pad to speed up ice production. This will increase ice production for the following 48 hours or until you press the pad again.



Door Alarm (on some models)

To set the alarm, press this pad until the indicator light comes on. This alarm will sound if either door is open for more than 3 minutes. The light goes out and the beeping stops when you close the door.



Reset
Hold 3 Sec

Water Filter (on some models)

The Filter Indicator Light will turn yellow when the filter is nearing expiration., and red when the filter is expired. After you replace the water filter, press and hold the Reset Filter pad for 3 seconds until the light turns off to reset the timer.



Filter Status (on some models)

Press the Filter Status pad to display the water filter's life percentage (%).

Important Facts About Your Dispenser

- Do not add ice from trays or bags to the storage drawer. It may not crush or dispense well.
- Avoid overfilling glass with ice and use of narrow glasses. Backed-up ice can jam the chute or cause the door in the chute to freeze shut. If ice is blocking the chute, poke it through with a wooden spoon.
- Beverages and foods should not be quick-chilled in the ice storage drawer. Cans, bottles or food packages in the storage drawer may cause the icemaker or auger to jam.
- To keep dispensed ice from missing the glass, put the glass close to, but not touching, the dispenser opening.
- Some crushed ice may be dispensed even though you selected CUBED ICE. This happens occasionally when a few cubes accidentally get directed to the crusher.
- After crushed ice is dispensed, some water may drip from the chute.
- Sometimes a small mound of snow will form on the door in the ice chute. This condition is normal and usually occurs when you have dispensed crushed ice repeatedly. The snow will eventually evaporate.

Care and Cleaning

Cleaning the Outside

The dispenser drip area, (on some models) beneath the grille, should be wiped dry. Water left in this area may leave deposits. Remove the deposits by adding undiluted vinegar to the well. Soak until the deposits disappear or become loose enough to rinse away.



The dispenser cradle (on some models). Before cleaning, lock the dispenser by pressing and holding the LOCK pad for 3 seconds. Clean with warm water and baking soda solution—about a tablespoon (15 ml) of baking soda to a quart (1 l) of water. Rinse thoroughly and wipe dry

FINGERPRINT RESISTANT STAINLESS STEEL*, BLACK STAINLESS, SLATE, DARK SLATE, PAINTED - Outside surfaces, door handles, and trim

DO NOT use Stainless Steel cleaners on the door surfaces.

IMPORTANT: The use of incorrect products may damage the outer finish of Fingerprint Resistant Stainless and Black Stainless models. Please follow these instructions and use only the appropriate items below to clean your appliance surfaces.

- Clean interior/exterior surfaces with warm water, mild soap or detergent, and a soft or microfiber cloth to avoid damage.
- Wipe the appliance surface dry with a soft clean cloth or microfiber towel to avoid streaking or water spotting.

* Easily wipe away smudges and fingerprints.

STAINLESS STEEL - Outside surfaces, door handles, and trim

NOTE: DO NOT allow stainless steel cleaner to come in contact with any plastic parts such as trim pieces, handle hardware and liners. If unintentional contact of cleaners with plastic parts does occur, clean plastic part with a sponge and mild detergent mixed with warm water.

Cleaning the Inside

To help prevent odors, leave an open box of baking soda in the fresh food and freezer compartments.

Unplug the refrigerator before cleaning.

If this is not practical, wring excess moisture out of sponge or cloth when cleaning controls, switches, lights or

Use an appliance wax polish on the inside surface between the doors.

Use warm water and baking soda solution-about a tablespoon (15 ml) of baking soda to a quart (1 liter) of water. This both cleans and neutralizes odors. Rinse and wipe dry.

CAUTION

Do not clean glass shelves or covers with warm water when they are cold. Glass shelves and covers may break if exposed to sudden temperature changes or impact such as bumping or dropping.

Tempered glass is designed to shatter into many small pieces if it breaks.

Behind the Refrigerator

Be careful when moving the refrigerator away from the wall. All types of floor coverings can be damaged, particularly cushioned coverings and those with embossed surfaces.

Pull the refrigerator straight out and return it to position by pushing it straight in. Moving the refrigerator in a side direction may result in damage to the floor covering or refrigerator.

When pushing the refrigerator back, make sure you don't roll over the power cord or water supply line.

Preparing for Vacation

For long vacations or absences, remove food and unplug the refrigerator. Clean the interior with a baking soda solution of one tablespoon (15 ml) of baking soda to one quart (1 liter) of water. Leave the doors open.

If the temperature can drop below freezing, have a qualified service technician drain the water supply system to prevent serious property damage due to flooding.

Preparing to Move

Secure all loose items such as shelves and drawers by taping them securely in place to prevent damage.

When using a hand truck to move the refrigerator, do not rest the front or back of the refrigerator against the hand truck. This could damage the refrigerator.

Handle only from the sides of the refrigerator.

Be sure the refrigerator stays in an upright position during moving.

Replacing the Light Bulbs

WARNING Before replacing a burned-out light bulb, the refrigerator should be unplugged in order to avoid contact with a live wire filament. (A burned-out light bulb may break when being replaced.) Turning the control to the OFF position does not remove power to the light circuit.

Refrigerator Compartment-Upper Light

1. Unplug the refrigerator.

2. The bulbs are located at the top of the compartment, inside the light shield. On some models, a screw at the front of the light shield will have to be removed. On other models, the screw is located in the pocket located at the back of the shield.
3. To remove the light shield, on some models, press in on the tabs on the sides of the shield and slide forward and out. On other models, just slide the shield forward and out. Your light shield will look like one of the following:
4. After replacing the bulb with an appliance bulb of the same or lower wattage, replace the light shield and screw. When replacing the light shield, make sure that the tabs at the back of the shield fit into the slots at the back of the light shield housing.
5. Plug the refrigerator back in.

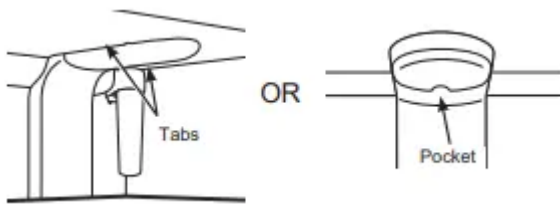

Replacing the Light Bulbs (Cont.)

WARNING

Before replacing a burned-out light bulb, the refrigerator should be unplugged in order to avoid contact with a live wire filament. (A burned-out light bulb may break when being replaced.)

Turning the control to the OFF position does not remove power to the light circuit.

Refrigerator Compartment-Lower Light

This light is located above the top drawer.

1. Unplug the refrigerator.
2. Lift the light shield up and pull it out.
3. After replacing the bulb with an appliance bulb of the same or lower wattage, replace the shield.
4. Plug the refrigerator back in.

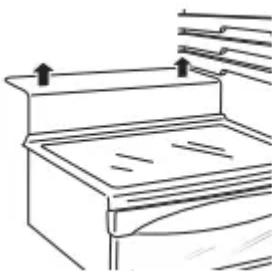

Freezer Compartment

1. Unplug the refrigerator.

2. Remove the shelf just above the light shield. (The shelf will be easier to remove if it is emptied first.) Remove the screw at the top of the light shield.
3. To remove the light shield, press in on the sides, and lift up and out.
4. Replace the bulb with an appliance bulb of the same or lower wattage, and reinstall the light shield. When reinstalling the light shield, make sure the top tabs snap securely into place. Replace the screw.
5. Reinstall the shelf and plug the refrigerator back in.

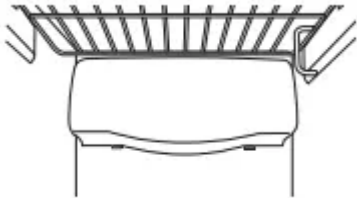

Dispenser (on some models)

1. Unplug the refrigerator.
2. The bulb is located on the dispenser under the control panel. Remove the light bulb by turning it counterclockwise.
3. Replace the bulb with a bulb of the same size and wattage.
4. Plug the refrigerator back in.

Replacing the lights on models with LED lighting (on some models)

Setting the controls to OFF does not remove power to the light circuit Not all features are on all models

Refrigerator Compartment

There is an LED lighting display in the top and sides of the fresh food compartment and in the rear and side of the freezer compartment on some models.

If this assembly needs to be replaced, call GE Appliances Service at 1.800.432.2737 in the United States or 1.800.561.3344 in Canada.

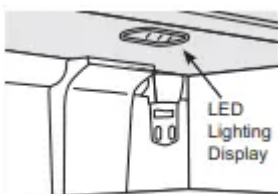

Installation Instructions

INSTALLING THE REFRIGERATOR

1 CONNECTING TO THE HOUSE WATER LINE (icemaker and dispenser models)

A cold water supply is required for automatic icemaker and dispenser operation. If there is not a cold water supply, you will need to provide one. See "Installing the Water Line" section.

NOTES:

- Before making the connection to the refrigerator, be sure the refrigerator power cord is not plugged into the wall outlet.
- If your refrigerator does not have a water filter, we recommend installing one if your water supply has sand or particles that could clog the screen of the refrigerator's water valve. Install it in the water line near the refrigerator. If using Universal Water Line Refrigerator Tubing Kit, you will need an additional tube (WX08X10002) to connect the filter. Do not cut plastic tube to install filter.

A If you are using copper tubing, place a compression nut and ferrule (sleeve) onto the end of the tubing coming from the house cold water supply.

If you are using the universal water line tubing, the nuts are already assembled to the tubing.

B If you are using copper tubing, insert the end of the tubing into the refrigerator connection, at the back of the refrigerator, as far as possible. While holding the tubing, tighten the fitting.

If you are using universal water line tubing, insert the molded end of the tubing into the refrigerator connection, at the back of the refrigerator, and tighten the compression nut until it is hand tight. Then tighten one additional turn with a wrench. Overtightening may cause leaks.

WARNING

Connect to potable water supply only.

A cold water supply is required for automatic icemaker operation. The water pressure must be between 40 and 120 psi (275-827 kilopascals).

WARNING ELECTRIC SHOCK HAZARD

Attach tubing clamp using existing hole only.

DO NOT drill into the refrigerator.

C Fasten the tubing into the clamp provided to hold it in position. You may need to pry open the clamp.

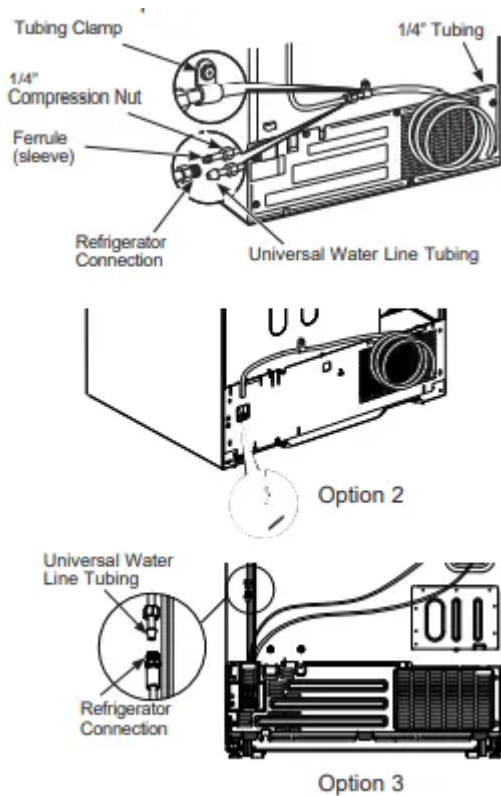

2 TURN ON THE WATER SUPPLY

Turn the water on at the shutoff valve (house water supply) and check for any leaks.

3 PLUG IN THE REFRIGERATOR

Before plugging in the refrigerator, make sure the icemaker power switch is set to the OFF position. See the grounding information attached to the power cord.

4 PUT THE REFRIGERATOR IN PLACE

Move the refrigerator to its final location.

5 LEVEL THE REFRIGERATOR

The refrigerator can be leveled by adjusting the rollers located near the bottom hinges

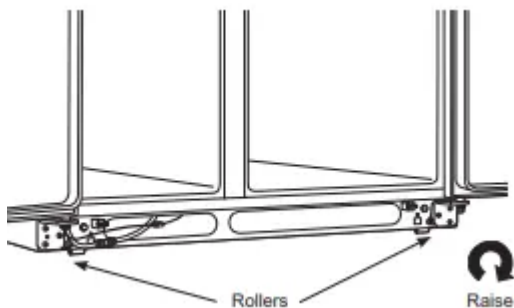

Rollers have three purposes:

- Rollers adjust so the door closes easily when opened about halfway (Raise the front about 5/8" [16 mm] from the floor)



- Rollers adjust so the refrigerator is firmly positioned on the floor and does not wobble
- Rollers allow you to move the refrigerator away from the wall for cleaning

To adjust the rollers on 23" (33" wide) 25', 26', 27' and 29 models:

- Turn the roller adjusting screws clockwise to raise the refrigerator, counterclockwise to lower 2 Use a 3/8" hex socket or wrench, or an adjustable wrench

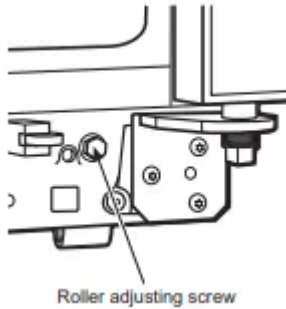

To adjust the rollers on 23/25 CustomStyle models

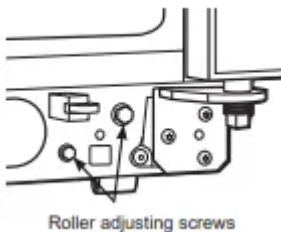

Turn the front roller adjusting screws clockwise to raise the refrigerator counterclockwise to lower it. Use a 3/8" hex wrench with extension, or an adjustable wrench.

These models also have rear adjustable rollers so you can align the refrigerator with your kitchen cabinets. Use a 3/8" hex wrench with extension to turn the screws for the rear rollers-clockwise to raise the refrigerator, counterclockwise to lower it

6 LEVEL THE DOORS

A Adjust the refrigerator door to make the doors even at the top

B To align:

Using a 7/16" wrench, turn the door adjusting screw to the right to raise the door, to the left to lower it

NOTE:

A nylon plug, imbedded in the threads of the pin, prevents the pin from turning unless a wrench is used

After one or two turns of the wrench, open and close the refrigerator door and check the alignment at the top of the doors

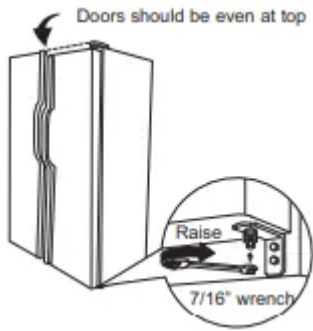

7 REPLACE THE BASE GRILLE

Replace the grille by installing the two Phillips head screws.

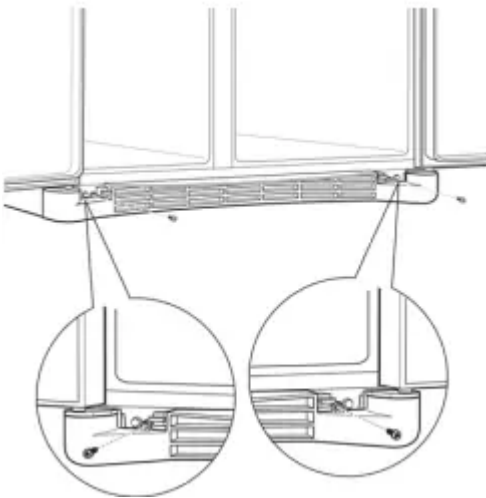

8 SET THE CONTROLS

Set the controls to the recommended setting.

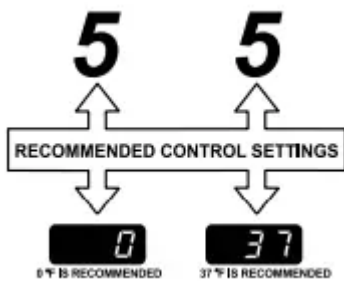

9 START THE ICEMAKER

Set the icemaker power switch to the I (on) position. The icemaker will not begin to operate until it reaches its operating temperature of 15°F (-9°C) or below. It will then begin operation automatically. It will take 2-3 days to fill the ice INTRIPLET bin.

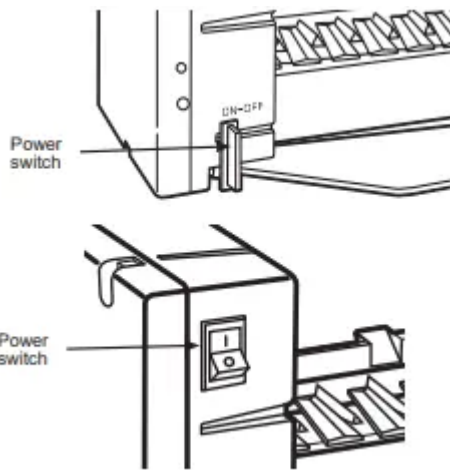

NOTE: In lower water pressure conditions, the water valve may turn on up to 3 times to deliver enough water to the icemaker.

INSTALLING THE WATER LINE (icemaker & dispenser models)

WHAT YOU WILL NEED

- Copper or SmartConnect™ Refrigerator Tubing kit, 1/4" outer diameter to connect the refrigerator to the water supply. If using copper, be sure both ends of the tubing are cut square.

To determine how much tubing you need: measure the distance from the water valve on the back of the refrigerator to the water supply pipe. Be sure there is sufficient extra tubing to allow the refrigerator to move out from the wall after installation.

SmartConnect™ Refrigerator Tubing Kits are available in the following lengths:

8' (2.8mm) - WX08X10006

15' (4.6 m) - WX08X10015

25' (7.6 m)- - WX08X10025

WARNING

Connect to potable water supply only.

A cold water supply is required for automatic icemaker operation. The water pressure must be between 40 and 120 psi (275-827 kilopascals)

NOTE: The only GE Appliances approved plastic tubing is that supplied in SmartConnect™

Refrigerator Tubing kits. Do not use any other plastic water supply line because the line is under pressure at all times. Certain types of plastic will crack or rupture with age and cause water damage to your home.

- A GE Appliances water supply kit (containing tubing, shutoff valve and fittings listed below) is available at extra cost from your dealer or from

- Parts and Accessories, 877.959.8688 (in Canada 1.800.661.1616).
- A cold water supply. The water pressure must be between 20 and 120 p.s.i. (138-827 kPa).
- Power drill.
- 1/2" or adjustable wrench.
- Straight and Phillips blade screwdriver.
- Two 1/4" outer diameter compression nuts and 2 ferrules (sleeves) to connect the copper tubing to the shutoff valve and the refrigerator water valve.
- If you are using a SmartConnect™ Refrigerator Tubing kit, the necessary fittings are preassembled to the tubing.
- If your existing copper water line has a flared fitting at the end, you will need an adapter (available at plumbing supply stores) to connect the water line to the refrigerator OR you can cut off the flared fitting with a tube cutter and then use a compression fitting. Do not cut formed end from SmartConnect™ Refrigerator tubing
- Shutoff valve to connect to the cold water line. The shutoff valve should have a water inlet with a minimum inside diameter of 5/32" at the point of connection to the COLD WATER LINE. Saddle-type shutoff valves are included in many water supply kits. Before purchasing, make sure a saddle-type valve complies with your local plumbing codes.

Install the shutoff valve on the nearest frequently used drinking water line.

1 SHUT OFF THE MAIN WATER SUPPLY

Turn on the nearest faucet long enough to clear the line of water.

2 CHOOSE THE VALVE LOCATION

Choose a location for the valve that is easily accessible. It is best to connect into the side of a vertical water pipe. When it is necessary to connect into a horizontal water pipe, make the connection to the top or side, rather than at the bottom, to avoid drawing off any sediment from the water pipe.

3 DRILL THE HOLE FOR THE VALVE

Drill a 1/4" hole in the water pipe (even if using a self-piercing valve), using a sharp bit. Remove any burrs resulting from drilling the hole in the pipe.

Take care not to allow water to drain into the drill.

Failure to drill a 1/4" hole may result in reduced ice production or smaller cubes.

4 FASTEN THE SHUTOFF VALVE

Fasten the shutoff valve to the cold water pipe with the pipe clamp.

NOTE: Commonwealth of Massachusetts Plumbing Codes 248CMR shall be adhered to. Saddle valves are illegal and use is not permitted in Massachusetts. Consult with your licensed plumber.

5 TIGHTEN THE PIPE CLAMP

Tighten the clamp screws until the sealing washer begins to swell.

NOTE: Do not over tighten or you may crush the tubing.

6 ROUTE THE TUBING

Route the tubing between the cold water line and the refrigerator.

Route the tubing through a hole drilled in the wall or floor (behind the refrigerator or adjacent base cabinet) as close to the wall as possible.

7 CONNECT THE TUBING TO THE VALVE

Place the compression nut and ferrule (sleeve) for copper tubing onto the end of the tubing and connect it to the shutoff valve.

Make sure the tubing is fully inserted into the valve. Tighten the compression nut securely.

For plastic tubing from a SmartConnect™ Refrigerator Tubing kit, insert the molded end of the tubing into the shutoff valve and tighten compression nut until it is hand tight, then tighten one additional turn with a wrench. Over tightening may cause leaks.

NOTE: Commonwealth of Massachusetts Plumbing Codes 248CMR shall be adhered to. Saddle valves are illegal and use is not permitted in Massachusetts. Consult with your licensed plumber.

8 FLUSH OUT THE TUBING

Turn the main water supply on and flush out the tubing until the water is clear.

Shut the water off at the water valve after about one quart (1 liter), or 2 minutes, of water has been flushed through the tubing.

To complete the installation of the refrigerator, go back to Step 11 in Installing the Refrigerator.

TROUBLESHOOTING TIPS

Normal Operating Conditions.

Newer refrigerators sound different from older refrigerators

Modern refrigerators have more features and use newer technology

Do you hear what I hear? These conditions are normal.

- The new high efficiency compressor may run faster and longer than your old refrigerator and you may hear a high-pitched hum or pulsating sound while it is operating.
- You may hear a whooshing sound when the doors close. This is due to pressure equalizing within the refrigerator.

CLICKS, POPS, CRACKS and SNAPS

- You may hear cracking or popping sounds when the refrigerator is first plugged in. This happens as the refrigerator cools to the correct temperature.
- Expansion and contraction of cooling coils during and after defrost can cause a cracking or popping sound.
- On models with an icemaker, after an ice making cycle, you may hear the ice cubes dropping into the ice bucket.
- On models with a dispenser, during water dispense, weder you may hear the water lines move at initial dispense and after dispenser button is released.

- You may hear the fans spinning at high speeds. This happens when the refrigerator is first plugged in, when the doors are opened frequently or when a large amount of food is added to the refrigerator or freezer compartments. The fans are helping to maintain the correct temperatures.
- The fans change speeds in order to provide optimal cooling and energy savings.

WATER SOUNDS

- The flow of refrigerant through the cooling coils may make a gurgling noise like boiling water.
- Water dropping on the defrost heater can cause a sizzling, popping or buzzing sound during the defrost cycle.
- A water dripping noise may occur during the defrost cycle as ice melts from the evaporator and flows into the drain pan.
- Closing the door may cause a gurgling sound due to pressure equalization.

Before you call for service

Filter Status Indicator LED turns amber

- Filter reaching expired state
 - Press the Filter Status pad to show remaining filter life.

Filter Status Indicator LED turns red

- Filter expired
 - Press the Filter Status pad to show remaining filter life. If the display shows 0%, the filter needs to be replaced. When the unit has detected a new filter (a filter has been replaced) the Filter Status LED will flash 3 times and then remain off to indicate the filter was successfully replaced.

LEAK or scrolling “LEAK” on the display Water is disabled Filter Status indicator LED flashing red Buzzer sound

- Filter leak detected
 - Replace filter. Wipe off the filter/surrounding area if there is any water from filter replacement.

“Err” on the display Water is disabled Filter Status indicator LED flashing red Buzzer sound

- Filter is not detected No communication with filter
 - Verify you have the XWFE filter and not the XWF. Verify there are no scratches or filter label damage. Replace filter if filter label shows damage.

Refrigerator beeps when pressing dispenser paddle

- Filter is not properly installed Filter water leak
 - Replace filter or make sure the water filter is properly installed (see water filter section).

Refrigerator does not operate

- Refrigerator in defrost cycle.
 - Wait about 30 minutes for defrost cycle to end.
- Either or both controls set to OFF.
 - Set the controls to a lower temperature setting.
- Refrigerator is unplugged.
 - Push the plug completely into the outlet.
- The fuse is blown/circuit breaker is tripped.
 - Replace fuse or reset the breaker.
- Refrigerator is in showroom mode.
 - Unplug the refrigerator and plug it back in.

Vibration or rattling (slight vibration is Leveling legs need adjusting. normal)

- Leveling legs need adjusting.
 - See Level the refrigerator.

Motor operates for long periods or cycles on and off frequently.(Modern refrigerators with more storage space and a larger freezer require more operating time. They start and stop often to maintain even temperatures.)

- Normal when refrigerator is first plugged Wait 24 hours for the refrigerator to completely cool down
 - Wait 24 hours for the refrigerator to completely cool down.
- Often occurs when large amounts of food are placed in refrigerator.
 - This is normal.
- Door left open.
 - Check to see if package is holding door open.
- Hot weather or frequent door openings.
 - This is normal.
- Temperature controls set at the coldest setting.
 - See Controls section

Refrigerator or freezer compartment too warm

- Temperature control not set cold enough.
 - See Controls section
- Warm weather or frequent door openings.
 - Set the temperature control one step colder. See Controls section
- Door left open.
 - Check to see if package is holding door open.

Frost or ice crystals on frozen food(frost within package is normal)

- Door left open.
 - Check to see if package is holding door open.
- Too frequent or too long door openings.
 - This is normal.

Divider between refrigerator and freezer compartments feels warm

- Automatic energy saver system circulates warm liquid around front edge of freezer compartment.
 - This helps prevent condensation on the outside.

Automatic icemaker does not work

- Icemaker power switch is in the OFF position.
 - Set the power switch to the ON position.
- See Installing the Water Line section
 - Water supply turned off or not connected.
- Freezer compartment too warm.
 - Wait 24 hours for the refrigerator to completely cool down.
- Piled up cubes in the storage bin cause the icemaker to shut off.
 - Level cubes by hand.
- Ice cubes stuck in icemaker.
 - Turn off the icemaker, remove cubes, and turn the icemaker back on.

Ice cubes have odor/taste

- Ice storage bin needs cleaning.
 - Empty and wash bin. Discard old cubes.
- Food transmitting odor/taste to ice cubes.
 - Wrap foods well.
- Interior of refrigerator needs cleaning.
 - See Care and Cleaning section.

Small or hollow cubes

- Water filter clogged
 - See Care and Cleaning section

Slow ice cube freezing

- Door left open.
 - Check to see if package is holding door open
- Temperature control not set cold enough.
 - See Controls section

Frequent buzzing sound"

- Icemaker power switch is in the 1 (on) position, but the water supply to the refrigerator has not been connected.
 - Set the power switch to the 0 (off) position. Keeping it in the 1 (on) position will damage the water valve.

Orange glow in the freezer

- Defrost heater is on.
 - This is normal.

Cube dispenser does not work (on some models)

- Icemaker or water supply turned off.
 - Turn on icemaker or water supply.
- Ice cubes are frozen to icemaker feeler arm.
 - Remove cubes.
- An item is blocking or has fallen into the ice chute inside the top bin of the freezer.
 - Remove any item that might be blocking, or has fallen into the chute.
- Irregular ice clumps in storage container.
 - Break up with fingertip pressure and discard remaining clumps.
 - Freezer may be too warm. Adjust the freezer control to a colder setting, one position at a time, until clumps do not form.
- Dispenser is LOCKED
 - Press and hold the Lock pad for 3 seconds.

Water has poor taste/odor

- Water dispenser has not been used for a long time.
 - Dispense water until all water in system is replenished.

Water in first glass is warm

- Normal when refrigerator is first installed.
 - Wait 24 hours for the refrigerator to completely cool down.
- Water dispenser has not been used for a long time.
 - Dispense water until all water in system is replenished.
- Water system has been drained
 - Allow several hours for replenished supply to chill.

Water dispenser does not work

- Water supply line turned off or not connected.
 - See Installing the water line section
- Water filter clogged.
 - Replace filter cartridge or remove filter and install plug

- Air may be trapped in the water system.
 - Press the dispenser arm for at least two minutes.
- Dispenser is LOCKED
 - Press and hold the LOCK pad for 3 seconds.

Water spurting from dispenser

- Newly-installed filter cartridge.
 - Run water from the dispenser for 3 minutes about one and a half gallons).

Water is not dispensed but icemaker is working

- Water in reservoir is frozen.
 - Call for service
- Refrigerator control setting is too cold.
 - Set to a warmer setting.

No water or ice cube production

- Supply line or shutoff valve is clogged
 - Call a plumber.
- Water filter clogged
 - Replace filter cartridge or remove filter and install plug

CUBED ICE was selected but CRUSHED ICE was dispensed (on some models)

- Last setting was CRUSHED ICE.
 - A few cubes were left in the crusher from the previous setting. This is normal.

Refrigerator has odor

- Foods transmitting odor to refrigerator.
 - Foods with strong odors should be tightly wrapped. Keep an open box of baking soda in the refrigerator, replace every three months.
- Interior needs cleaning
 - See Care and Cleaning section

Moisture forms on outside of refrigerator

- Not unusual during periods of high humidity.
 - Wipe surface dry

Moisture collects inside (in humid weather, air carries moisture into refrigerator when doors are opened)

- Too frequent or too long door openings
 - This is normal.
- Due to the higher humidity in the refrigerator, you may on occasion experience fog or small amounts of moisture in the refrigerator compartment.
 - This is normal and may come and go as different food loads and environmental conditions change. Wipe dry with a paper towel if desired.

Interior light does not work

- No power at outlet
 - Replace fuse or reset the breaker.
- LED lights are out
 - Call Service-see Replacing the Lights

Water on kitchen floor or on bottom of freezer

- Cubes jammed in chute.
 - Poke ice through with a wooden spoon.

Hot air from bottom of refrigerator

- Normal air flow cooling motor refrigeration process, it is normal that heat be expelled in the area under the refrigerator. Some floor coverings are sensitive and will discolor at these normal and safe temperatures.
 - This is normal.

Refrigerator never shuts off but the temperatures are OK

- Adaptive defrost keeps compressor running during door openings.
 - This is normal. The refrigerator will cycle off after the door remains closed for 2 hours.

Refrigerator is beeping

- Door is open.
 - Close door.

Door not closing properly

- Door gasket on hinge side sticking or folding over.
 - Apply paraffin wax to the face of the gasket.

Actual temperature not equal to Set temperature

- Unit just plugged in.
 - Allow 24 hours for system to stabilize.
- Door open for too long.
 - Allow 24 hours for system to stabilize.
- Warm food added to refrigerator.
 - Allow 24 hours for system to stabilize.
- Defrost cycle is in process.
 - Allow 24 hours for system to stabilize.

Warning

This content is compiled from multiple sources and is provided for reference purposes only. It may not be complete or fully applicable to all situations. If you are unable to resolve your issue, please contact the product manufacturer or an authorized service provider for official support.