

What comes in the carton

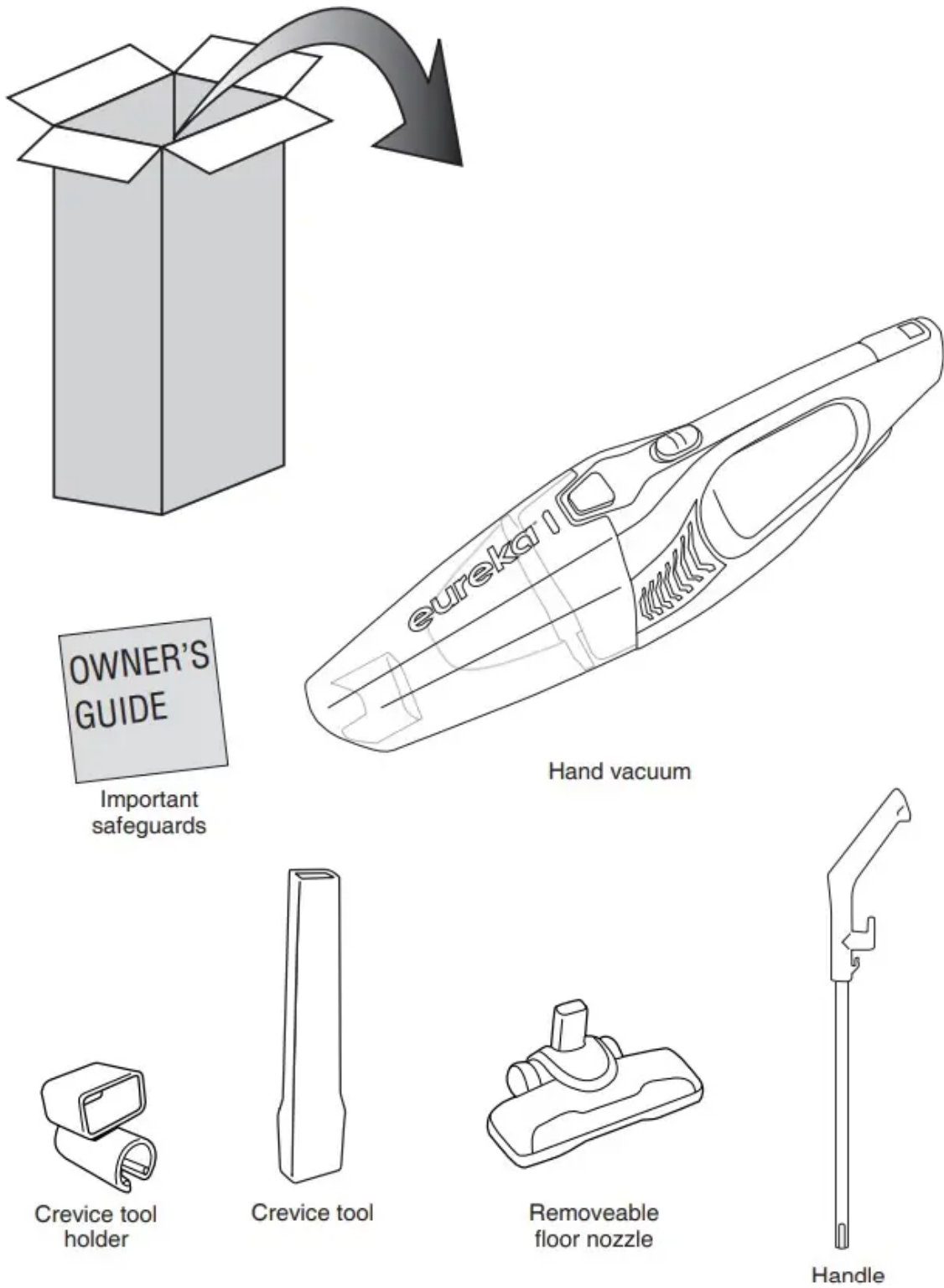

How to identify parts of your vacuum cleaner

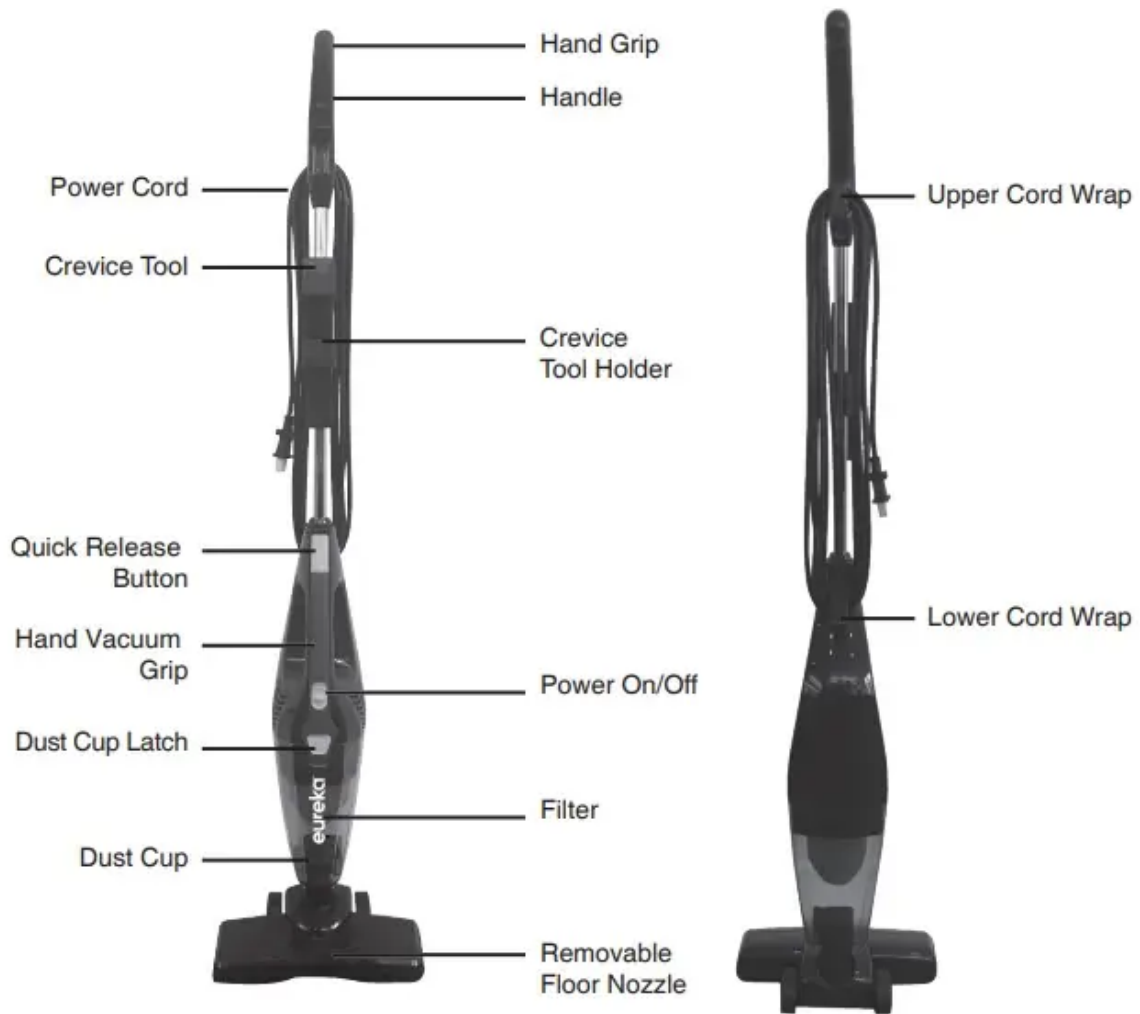

How to assemble your vacuum cleaner

- Attach crevice tool and holder by sliding it up onto the handle.

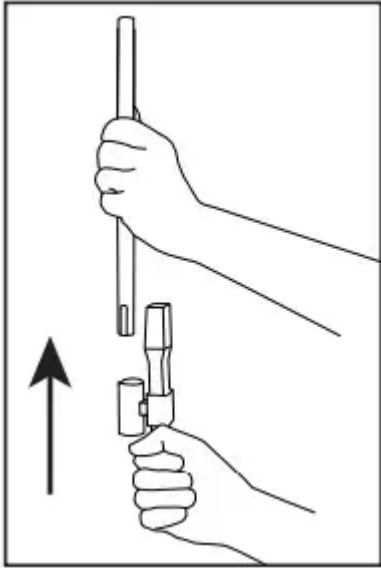

- Press the quick release button on the hand vacuum grip and insert the handle. Make sure it is all the way inserted into the body of the vacuum.

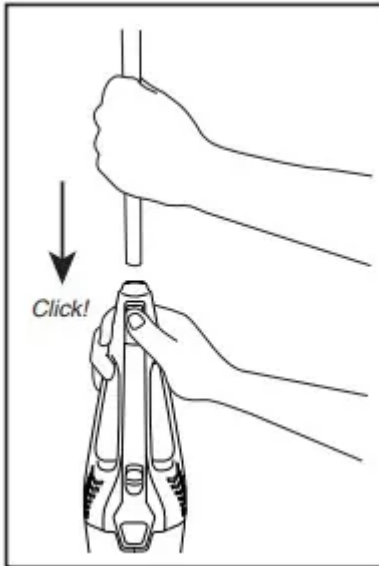

- Attach the floor nozzle by inserting it into the opening at the bottom of the dust cup. Press firmly to secure in place

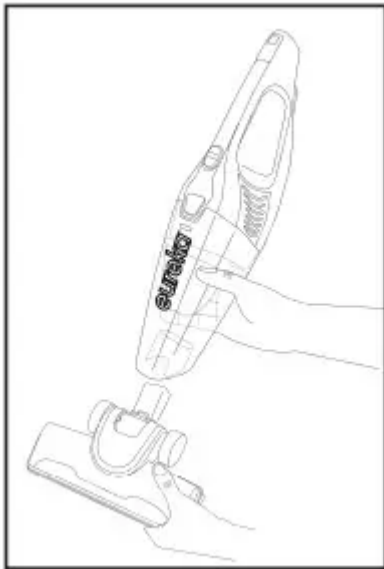

- Wrap cord around the upper and lower cord wraps on the back of the vacuum. Clip plug onto the cord.

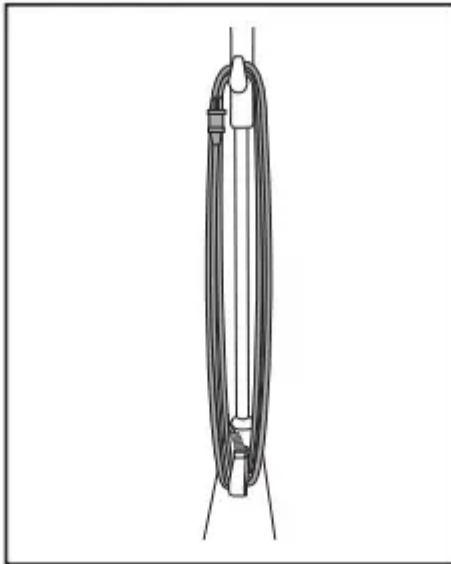

- Tilt vacuum up into its upright position.

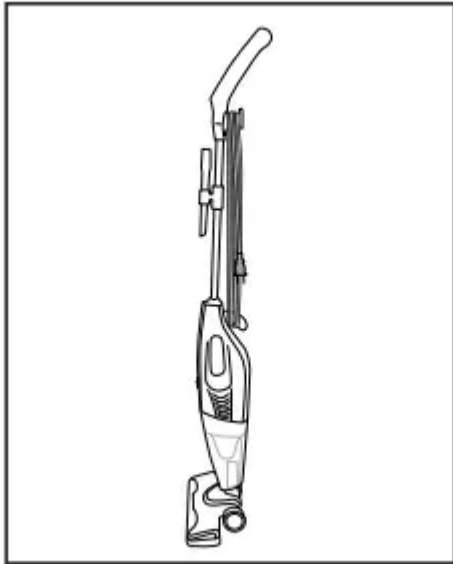

How to use your vacuum cleaner

- Plug power cord into the outlet.

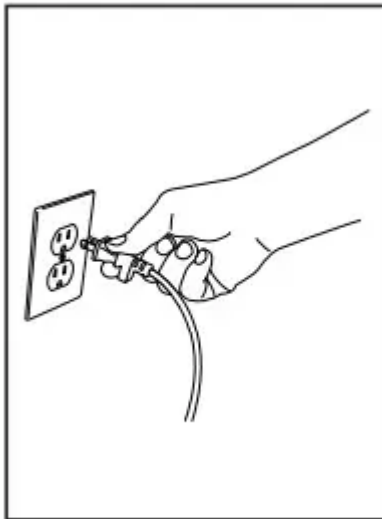

- Turn on power switch on the front of the hand vacuum.

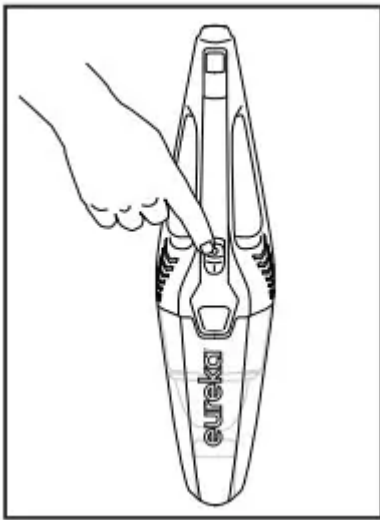

- Step on nozzle and tilt vacuum to release from its upright position.

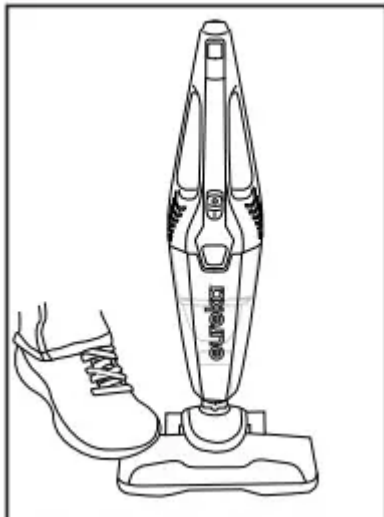

Additional usage methods

- Turn hand vacuum 180° as shown for better reach under furniture.

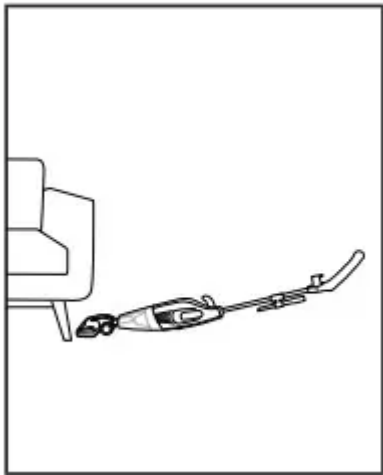

- Floor nozzle may be used with the hand vacuum to clean wider surfaces. To attach floor nozzle to the hand vacuum, insert it into the opening at the bottom of the hand vacuum. Press firmly to secure in place.

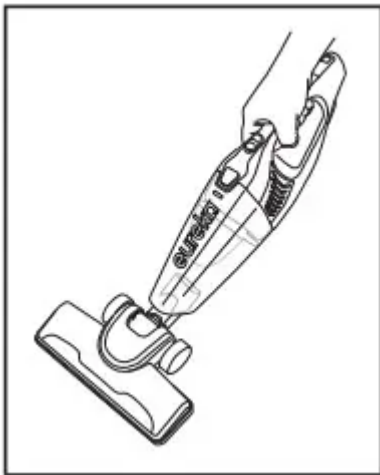

- Insert crevice tool to extend the length and reach of the hand vacuum.

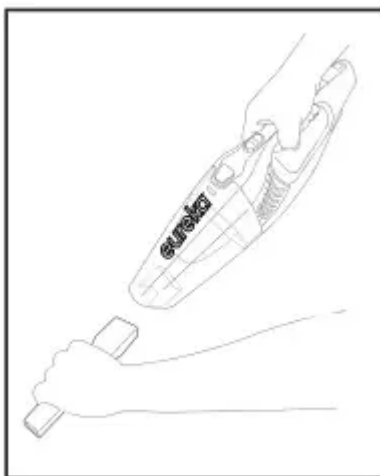

How to maintain dust cup and filters

- Turn vacuum off. Then, unplug the vacuum.

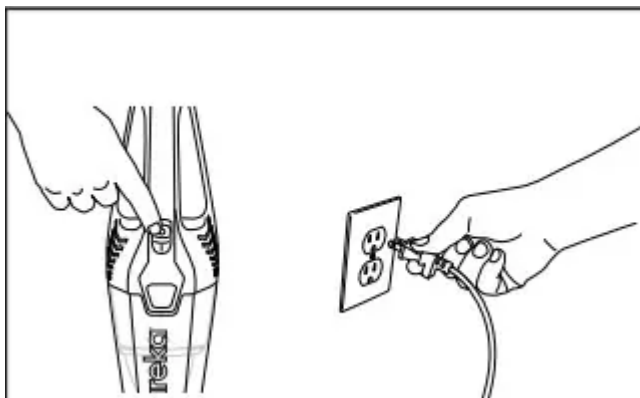

- To remove dirt from the dust cup and filter, hold vacuum vertically. Press dust cup latch to release the dust cup as shown.

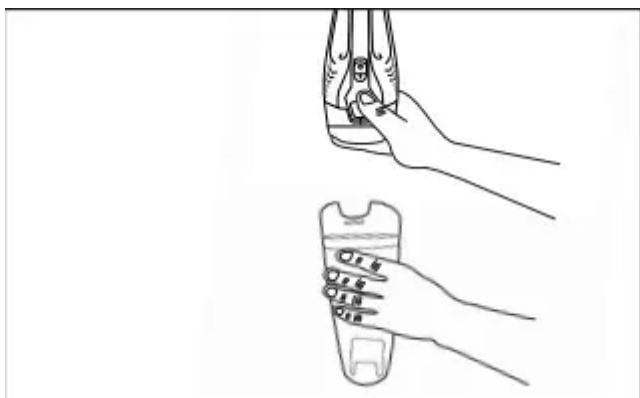

- Gently remove the filter as shown.



- Empty dust cup into waste container.

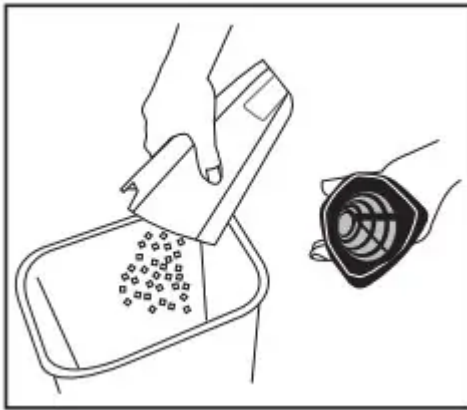

- Replace filter. Attach dust cup to vacuum. Make sure dust cup is correctly secured.

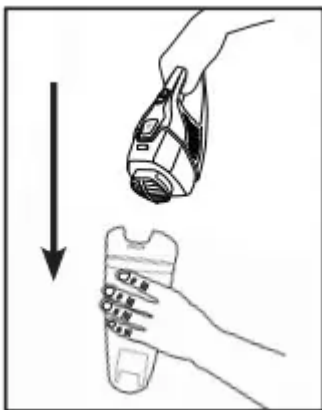

Maintaining pre-motor filter

- To optimize suction and cleaning performance, remove and inspect the pre-motor filter regularly.

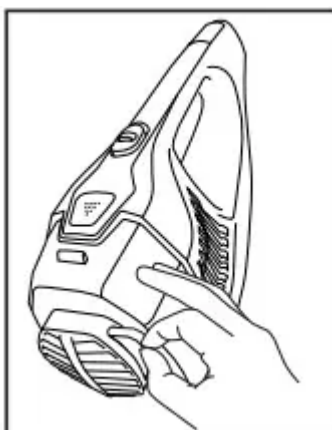

- If needed, clean with warm water and a mild detergent.

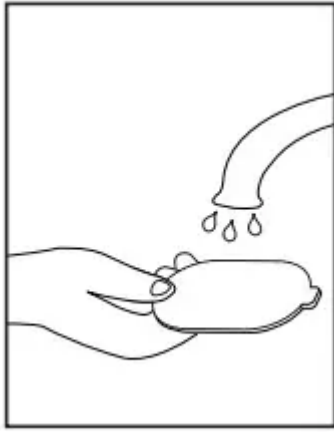

- Air dry pre-motor filter for 24 hours before placing back in the vacuum.

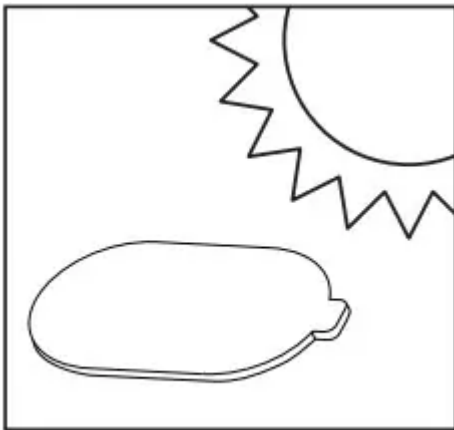

Problem Solving

Motor will not start.

1. Push plug securely into outlet, try another outlet, or check circuit breaker.





Vacuum cleaner does not vacuum effectively.

1. Filters may be clogged, wet, or dirty. Follow instructions for cleaning filters.
2. Dust cup may be full. Follow instructions for emptying dust cup.

Dust blows out of air vents.

1. Ensure filters are properly secured.

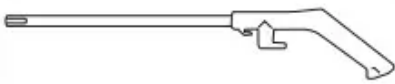
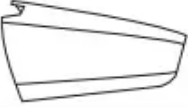
Parts and Accessories

	Filter	N0101
	Pre-motor filter	N0102
	Crevice tool	N0103
	Handle	N0104
	Dust cup	N0105
	Nozzle	N0106
	Crevice tool holder	N0107

Important safeguards

To reduce the risk of fire, electric shock, or injury:

- Do not use outdoors or on wet surfaces.
- Do not leave vacuum cleaner when plugged in. Turn off the switch and unplug the electrical cord when not in use and before servicing.
- Do not allow to be used as a toy. Close attention is necessary when used by or near children.
- Use only as described in this manual. Use only manufacturer's recommended attachments.
- Do not use with damaged cord or plug. If vacuum cleaner is not working as it should, has been dropped, damaged, left outdoors, or dropped into water, return it to a service center before using.
- Do not pull or carry by cord. Do not use cord as a handle. Do not close a door on cord or pull cord around sharp edges or corners. Do not run vacuum cleaner over cord. Keep cord away from heated surfaces.

- Do not use extension cords or outlets with inadequate current carrying capacity.
- Turn off all controls before unplugging.
- Do not unplug by pulling on cord. To unplug, grasp the plug, not the cord.
- Do not handle plug or vacuum cleaner with wet hands.
- Do not put any objects into openings. Do not use with any openings blocked; keep free of dust, lint, hair, and anything that may reduce airflow.
- This vacuum cleaner creates suction. Keep hair, loose clothing, fingers, and all parts of body away from openings and moving parts.
- Use extra care when cleaning stairs.
- Do not pick up anything that is burning or smoking such as cigarettes, matches, or hot ashes.
- Do not use without dust cup, filter, and pre-motor filter in place.
- Do not use to pick up flammable or combustible liquids such as gasoline, or use in areas where they may be present.
- Store your vacuum cleaner indoors in a cool, dry area.
- Keep your work area well lighted.
- Unplug electrical appliances before vacuuming them.

Warning

This content is compiled from multiple sources and is provided for reference purposes only. It may not be complete or fully applicable to all situations. If you are unable to resolve your issue, please contact the product manufacturer or an authorized service provider for official support.