

## PRODUCT DESCRIPTION

### Appliance overview

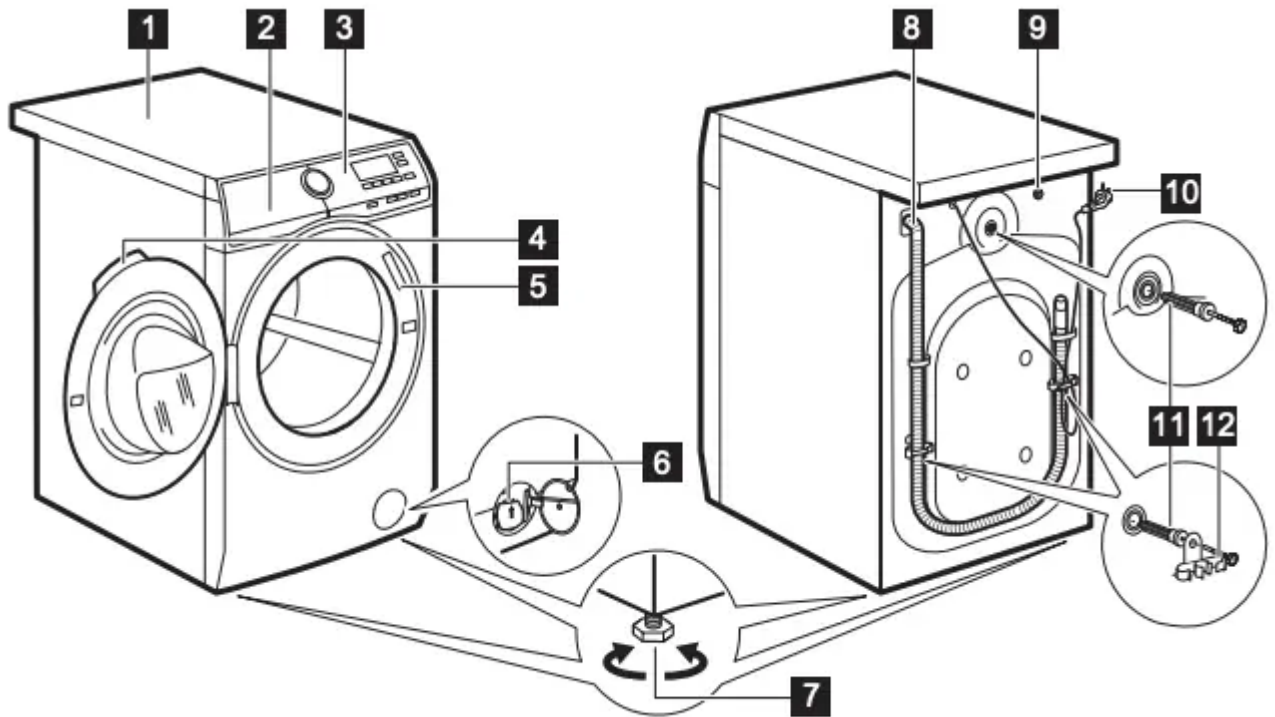

*1 Worktop*

*2 Detergent dispenser*

*3 Control panel*

*4 Door handle*

*5 Rating plate*

*6 Drain pump filter*

*7 Feet for levelling the appliance*

*8 Drain hose*

*9 Inlet hose connection*

*10 Mains cable*

*11 Transit bolts*

*12 Hose support*

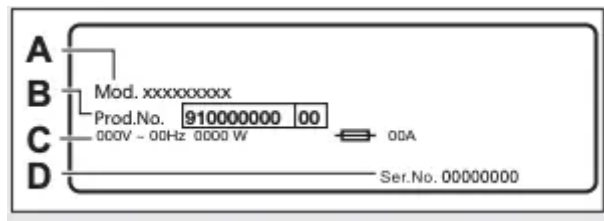

The rating plate reports the model name (A), product number (B), electrical ratings (C) and serial number (D).

## CONTROL PANEL

### Control panel description

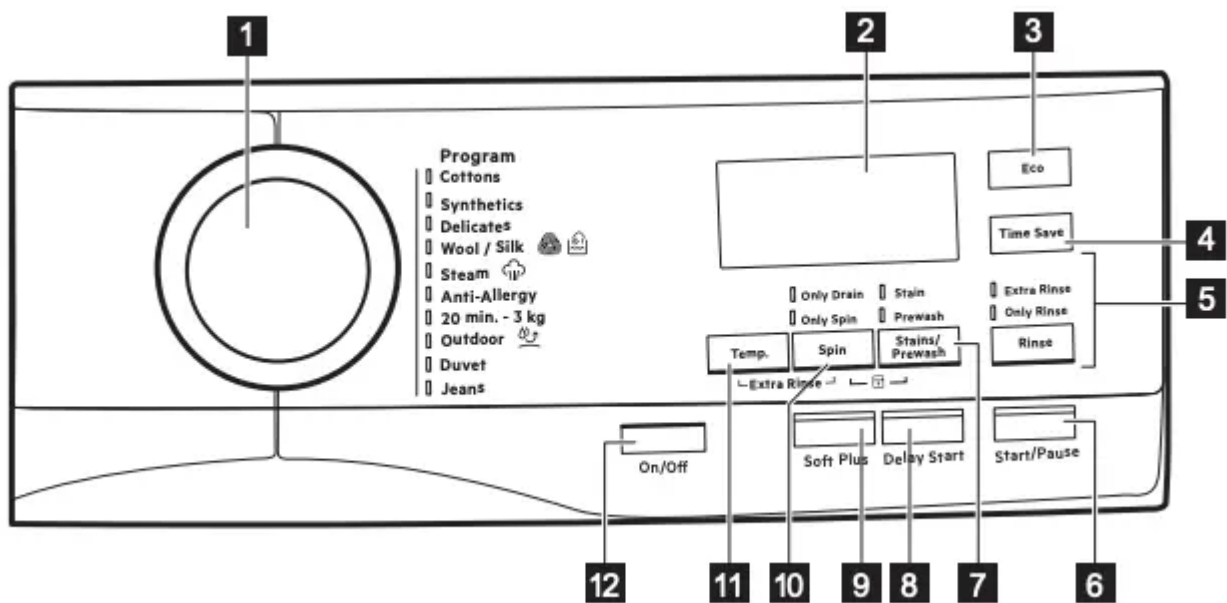

1 Program dial

2 Display

3 Eco touch button

4 Time Save touch button

5 Rinse touch button

- Extra rinse option

- Skipping wash phase - Only Rinse option

6 Start/Pause touch button

7 Stains/Prewash touch button

- Stain option

- Prewash option

8 Delay start touch button

9 Soft Plus touch button

10 Spin reduction touch button

• Rinse Hold option 

• Extra Silent option 

• Skipping wash and rinse phases - Only Spin option













• Skipping wash, rinse and spin phases - Only Drain option

11 Temperature touch button

12 On/Off push button

## Display



	Maximum load indicator. The <b>kg</b> indicator flashes during the laundry load estimation (refer to ProSense load detection paragraph) .
<b>MAX</b>	Maximum laundry indicator. It blinks if the laundry amount exceeds the declared load.
	Door locked indicator.
	Delay start indicator.
	The digital indicator can show: <ul style="list-style-type: none"> <li>• Program duration (e. g. <b>2:40</b>).</li> <li>• Delay time (e. g. <b>30'</b> or <b>2h</b>).</li> <li>• Cycle end (<b>0</b>).</li> <li>• Warning code (e.g. <b>E20</b>).</li> </ul>
	Washing phase indicator. It flashes during pre-wash and wash phase.
	Rinsing phase indicator. It flashes during rinse phase.
	When the Permanent Extra Rinse option is activated, the <b>+</b> indicator appears.
	Spinning and draining phase indicator. It flashes during spin and drain phase.
	Steam phase indicator.
	Child safety lock indicator.
<b>ECO</b>	Energy saving indicator.
	Time saving indicator.
<b>1400</b>	Spin speed indicator.
	Rinse hold indicator.
	Extra silent indicator.
<b>88</b>	Temperature indicator. The <b>*</b> indicator appears when a cold wash is set.

## DIAL AND BUTTONS

### On/Off



Pressing this button for a few seconds allows to activate or deactivate the appliance. Two different tunes sound while switching the appliance on or off.

As the Stand-by function automatically deactivates the appliance to decrease the energy consumption in a few cases, you may need to activate the appliance again.

For more details, refer to Stand-by paragraph in Daily Use chapter.

### Temp.

When you select a washing program, the appliance automatically proposes a default temperature. Touch this button repeatedly until the desired temperature value appears on the display.

When the display shows the indicators  and , the appliance does not heat the water.

### Spin

When you set a program, the appliance automatically sets the maximum spin speed allowed. Touch repeatedly this button to:

- Decrease the spin speed.



The display shows only the spin speeds available for the set program

- **Activate the Rinse Hold option.** The final spin is not performed. The water of the last rinse is not drained out to prevent the fabrics from creasing. The washing program ends with water in the drum. The display shows the indicator . The door stays locked and the drum turns regularly to reduce creasing. You must drain the water to unlock the door. If you touch the Start/Pause button, the appliance performs the spinning phase and drains the water.



The appliance empties the water out automatically after 18 hours approximately.

- **Activate the Extra Silent option.** The intermediate and the final spinning phases are suppressed and the programme ends with water in the drum. This helps to reduce creasing. The display shows the indicator . The door stays locked. The drum turns regularly to reduce creasing. You must drain the water to unlock the door. As the program is very quiet, it is suitable for use at night time when cheaper electricity tariffs are available. In some programs the rinses are performed with more water. If you touch the Start/Pause button, the appliance performs the only draining phase.



The appliance empties the water out automatically after 18 hours approximately

- **Activate the drain-only option** (Skipping the wash, rinse and spin phases): Only Drain. The appliance performs the only draining phase of the selected washing programme. The display shows the indicator (cold), and the indicator (no spin) and the indicator .
- **Activate the spin-only option** (Skipping the wash and rinse phases): Only Spin.



Before setting this option, select a suitable washing program for the garments. The appliance will perform the most fitting spin cycle for your garments care (e.g. For synthetics items, first select the Synthetics washing program and then the Only Spin option).

The appliance performs only the spinning phase of the selected washing program.

The display shows the indicator (cold), the phase indicator and the spin speed.

## Stains/Prewash

Press this button repeatedly to activate one of the two options. The relevant indicator goes on in the display.

- **Stain**

Select this option to add an anti-stain phase to a program in order to treat heavily soiled or stained laundry with stain remover. Pour the stain remover into compartment . The stain remover will be added in the appropriate phase of the washing program.



This option is not available with a temperature lower than 40 °C

- **Prewash**

Use this option to add a pre-wash phase at 30 °C before the washing phase. This option is recommended for heavily soiled laundry, especially if containing sand, dust, mud and other solid particles.



The options can increase the program duration.

## Soft Plus

Set the Soft plus option to optimise the fabric softener distribution and improve the fabric softness. It is suggested when you use the fabric softener.



This option slightly increases the program duration.

## Delay Start

With this option you can delay the start of a program in a more convenient time. Touch the button repeatedly to set the required delay. The time increases by steps of 30 minutes up to 90' and from 2 hours up to 20 h.

After touching the Start/Pause button, the display shows the indicator  and the selected delay time and the appliance begins the countdown.

## Rinse

With this button you can select one of the following options:

### • Extra Rinse option

This option adds a few rinses according to the selected washing program. Use this option for persons allergic to detergent residues and in areas where the water is soft.



This option increases slightly the program duration.

### • Skipping wash phase - Only Rinse option

The appliance performs only the rinsing phase, the spinning and the draining phases of the selected program. The corresponding indicator above the touch button illuminates.

## Time Save

With this option you can decrease the program duration.

- If your laundry is normally or lightly soiled, it may be advisable to shorten the washing program. Touch this button once to decrease the duration.
- In case of smaller load, touch this button twice to set an extra quick program.

The display shows the indicator .



This option can also be used to shorten the Steam program duration.

## Eco

Set this option for slightly or normally soiled items washed at 30°C or higher temperatures.

The appliance decreases the washing temperature and extends the washing time to obtain a good washing efficiency by saving energy. The display shows the indicator **ECO**.





## **Start/Pause**

Touch the Start/Pause button to start, pause the appliance or interrupt a running program.



# PROGRAMS

## Program Chart



Program	Program description
<b>Washing programs</b>	
Cottons	White cotton and coloured cotton. Normally, heavily and lightly soiled items.
Synthetics	Synthetic items or mixed fabric items. Normally soiled items
Delicates	Delicate fabrics such as acrylics, viscose and mixed fabrics requiring gentler washing. Normally and lightly soiled items.
 Wool/Silk	Machine washable wool, hand washable wool and other fabrics with «hand washing» care symbol(1) .
<b>Steam program</b>	
 Steam	<p>Steam program for cotton and synthetic items. Steam can be used for dried<sup>2</sup>), washed or worn once laundry. This program reduce creases and odours<sup>3</sup>) and relaxes the fibres. When the program is completed, quickly remove the laundry from the drum. After a steam program, ironing becomes effortless. Do not use any detergent. If necessary, remove stains by washing or using localized stain removal. Steam programs do not perform any hygienic cycle. Do not set a Steam program with these types of items:</p> <ul style="list-style-type: none"> <li>• Items that are not suitable for tumble drying.</li> <li>• Items with label "Dry clean only".</li> </ul>
<b>Washing programs</b>	
Anti-Allergy	White cotton items. This program removes micro-organisms thanks to a washing phase with the temperature maintained above 60°C for several minutes. This helps remove germs, bacteria, micro-organism and particles. An additional rinsing phase ensures a proper removal of detergent residues and pollens/allergenic items. In this way the wash is more effective.
20 min. - 3 kg	Cotton and synthetic items lightly soiled or once worn.
 Outdoor	 Do not use fabric softener and make sure that there is no softener residue in the detergent dispenser.

Outdoor clothing, technical, sport fabrics, waterproof and breathable jackets, shell jackets with a removable fleece or inner insulation. The recommended laundry load is 2.5 kg. This program can also be used as water-repellent restoring cycle, specifically tailored for treating clothes with a hydrophobic coating. To perform the water-repellent restoring cycle, proceed as follows:

- Pour the washing detergent in the compartment  .
- Pour a special water-repellent restorer for fabric in the drawer compartment for fabric softener  .
- Reduce the laundry load to 1 kg.



To further improve the water-repellent restoring action, dry the laundry in a tumble dryer by setting the Outdoor drying program (if available and if the garment care label permits tumble drying).



Duvet	Single synthetic blanket, padded clothes, duvets, down jackets and similar items.
Jeans	Denim clothing and jersey items. Normal soiled. This program performs a gentle rinsing phase, designed for denim, that reduces fading and does not cause washing powder residues on the fibres.

1) During this cycle the drum rotates slowly to ensure a gentle wash. It can seem that the drum doesn't rotate or doesn't rotate properly, but this is normal for this program.

2) If you set a Steam program with dried laundry, at the end of the cycle the laundry can be humid. Line dry the items for about 10 minutes.

3) Steam program doesn't remove particularly intense odour.

Program temperature, maximum spin speed and maximum load







Program	Default temperature Temperature range	Reference spin speed Spin speed range	Maximum load
<b>Washing programs</b>			
Cottons <sup>1)</sup>	40 °C 95 °C - Cold	1400 rpm 1400 rpm - 400 rpm	8 kg
Synthetics	40 °C 60 °C - Cold	1200 rpm 1200 rpm - 400 rpm	3 kg
Delicates	40 °C 40 °C - Cold	1200 rpm 1200 rpm - 400 rpm	3 kg
 Wool/Silk	40 °C 40 °C - Cold	1200 rpm 1200 rpm - 400 rpm	1.5 kg
<b>Steam program</b>			
 Steam	-	-	1 kg
<b>Washing programs</b>			
Anti-Allergy	60 °C	1400 rpm 1400 rpm - 400 rpm	8 kg
20 min. - 3 kg	30 °C 40 °C - 30 °C	1200 rpm 1200 rpm - 400 rpm	3 kg
 Outdoor	30 °C 40 °C - Cold	1200 rpm 1200 rpm - 400 rpm	2.5 kg <sup>2)</sup> 1 kg <sup>3)</sup>
Duvet	40 °C 60 °C - Cold	800 rpm 800 rpm - 400 rpm	2.5 kg
Jeans	40 °C 60 °C - Cold	1200 rpm 1200 rpm - 400 rpm	8 kg

1) The Cottons 40 °C program with the ECO option and 1400 rpm is recommended for a full load of normally soiled cotton and is the energy and water rating label program in accordance with AS/NZS2040.2 and AS/NZS6400.

2) Washing program.

3) Washing program and waterproofing phase.

### Program options compatibility

	Cottons	Synthetics	Delicates	Wool/Silk 	Steam 	Anti-Allergy	20 min. - 3 kg	Outdoor 	Duvet	Jeans
Spin	■	■	■	■		■	■	■	■	■
Rinse Hold 	■	■	■	■		■		■		■
Extra Silent 	■	■	■							
Only Drain	■	■	■	■		■	■	■	■	■
Only Spin <sup>1)</sup>	■	■	■	■		■	■	■	■	■
Stain <sup>2)</sup>	■	■	■			■				■
Prewash	■	■	■			■				■
Extra Rinse	■	■	■			■				■
Only Rinse	■	■	■	■		■	■	■	■	■
 ECO <sup>3)</sup>	■	■	■						■	■
Time Save <sup>4)</sup>	■	■	■		■					■
Delay Start	■	■	■	■	■	■	■	■	■	■
Plus Steam <sup>5)</sup>	■	■				■				■
Soft Plus	■	■	■			■			■	■

1) Before setting this option, select a suitable washing program for the garments. The appliance will perform the most fitting spin cycle for your garments care (e.g. For synthetics items, first select the Syn-thetics washing program and then the Only Spin option).

2) This option is not available with temperature lower than 40 °C.

3) This option is not available with a temperature lower than 30 °C.

4) If you set the shortest duration, we recommend that you decrease the load size. It is possible to fully load the appliance, however the washing results can be less satisfactory.

5) This option is not available with temperature lower than 40 °C.

## BEFORE FIRST USE



During installation or before first use you may observe some water in the appliance. This is a residual water left in the appliance after a full functional test in the factory to ensure the appliance is delivered to customers in perfect working order and is no cause for concern.

1. Make sure that all transit bolts have been removed from the appliance.
2. Make sure that the electrical power is available and the water tap is open.
3. Remove the folded tag in the detergent compartment marked by . This tag suggests to use the right amount of detergent or softener for avoiding overdosing.

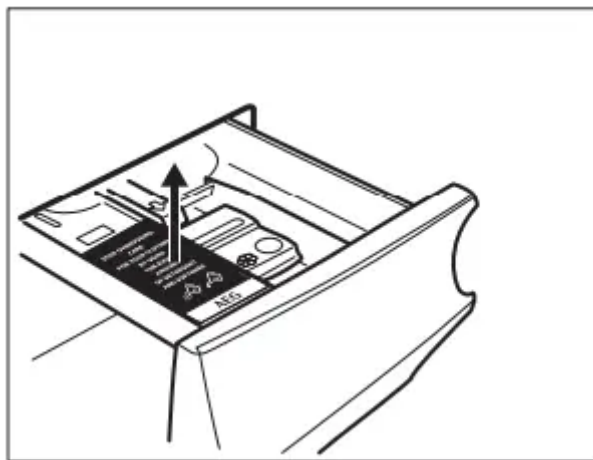

4. Pour 2 litres of water into the detergent compartment marked by . This action activates the drain system.
5. Set and start a programme for cotton at the highest temperature without any detergent and laundry in the drum.

## DAILY USE

**WARNING!** Refer to Safety chapters.

### Activating the appliance

1. Connect the mains plug to the mains socket.
2. Open the water tap.
3. Press the On/Off button for a few seconds to activate the appliance. A short tune sounds (if activated). The appliance automatically proposes a default program. The relevant indicator illuminates. The display shows the maximum load, the default temperature, the

default spin speed, the indicators of the phases making up the program and the cycle duration.

## Loading the laundry

1. Open the appliance door.
2. Shake the items before you put them in the appliance.
3. Put the laundry in the drum, one item at a time. Make sure not to put too much laundry in the drum.
4. Close the door firmly.

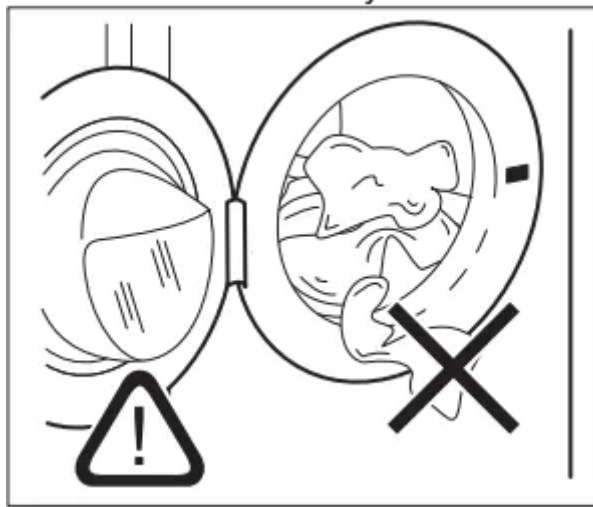

**CAUTION!** Make sure that no laundry stays between the seal and the door. There is a risk of water leakage or damage to the laundry.

**CAUTION!** Washing heavily oiled, greasy stains could cause damage rubber parts of the washing machine.

## Filling the detergent and additives

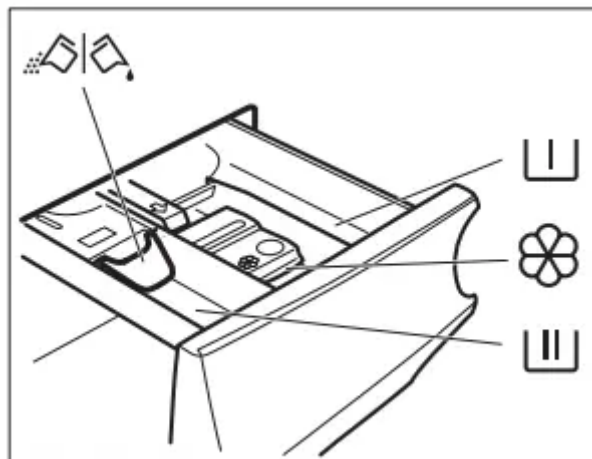



Before using the detergent dispenser, make sure that the folded tag in the compartment



has been removed. Refer to "Before first use" chapter.



Compartment for prewash phase, soak programme or stain remover



Compartment for washing phase.



Compartment for liquid additives (fabric conditioner, starch).

**MAX**

Maximum level for quantity of liquid additives.



Flap for powder or liquid detergent.



Always follow the instructions that you find on the packaging of the detergent products, but

we recommend that you do not exceed the maximum indicated level (**MAX**). This quantity will however guarantee the best washing results



After a washing cycle, if necessary, remove any detergent residue from the detergent dispenser.

### Check the position of the flap

1. Pull out the detergent dispenser until it stops.
2. Press the lever down to remove the dispenser.

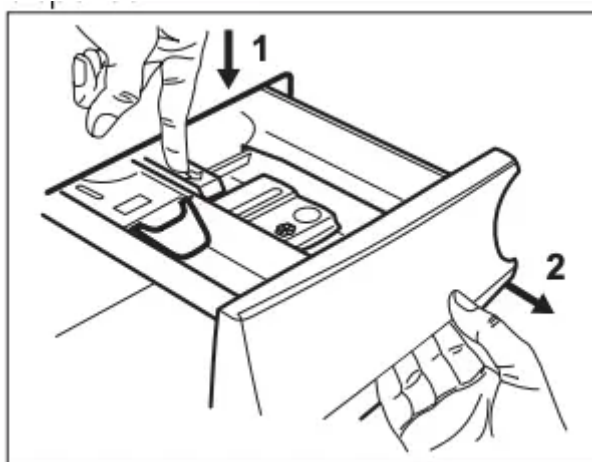

3. To use powder detergent, turn the flap up.

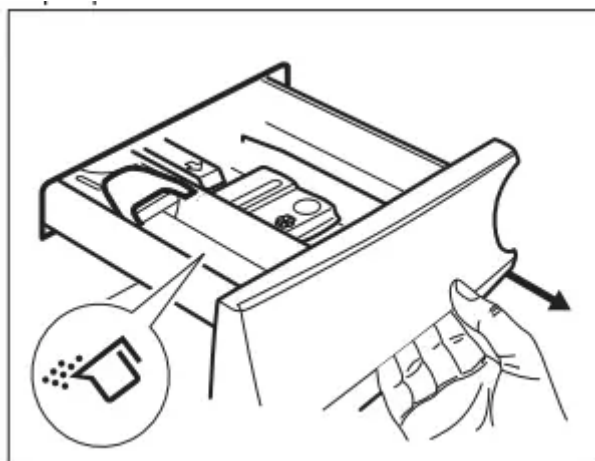

4. To use liquid detergent, turn the flap down.

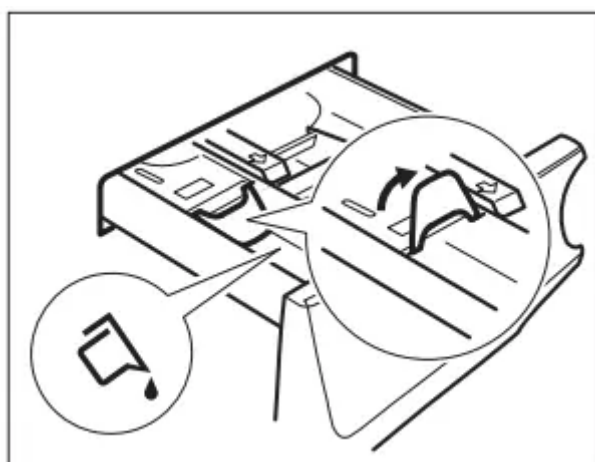

**With the flap in the position DOWN:**

- Do not use gelatinous or thick liquid detergents.
  - Do not put more liquid detergent than the limit shown on the flap.
  - Do not set the prewash phase.
  - Do not set the delay start function
5. Measure out the detergent and the fabric conditioner.
6. Carefully close the detergent dispenser.

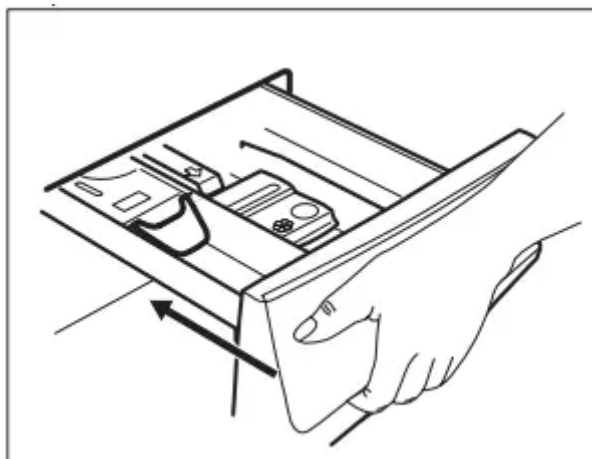

Make sure that the flap does not cause a blockage when you close the drawer.

## Setting a program

1. Turn the program dial to select the desired washing program. The related program indicator comes on.

The indicator of the Start/Pause button flashes. The display shows the maximum declared load for the program, the default temperature, the default spin speed, the washing phase indicators (when available) and an indicative program duration.

2. To change the temperature and/or the spin speed, touch the related buttons.
3. If desired, set one or more options by touching the related buttons. The related indicators come on in the display and the given information changes accordingly.



In case a selection is not possible, no indicator comes on and an acoustic signal sounds.

## Starting a program

Touch the Start/Pause button to start the program. The related indicator stops flashing and stays on. In the display, the indicator of the operating phase starts flashing. The program starts, the door is locked. The display shows the indicator .



The drain pump can operate shortly before the appliance fills water.

## Starting a program with the delay start

1. Touch this repeatedly until the display shows the desired delay time. The indicator  comes on.
2. Touch the Start/Pause button. The appliance starts the countdown of the delay start. When the countdown is completed, the programme starts.



The ProSense estimation starts at the end of the countdown.

## Cancelling the delay start after the countdown has started

To cancel the delay start:

1. Touch the Start/Pause button to pause the appliance. The related indicator flashes.
2. Touch the Delay Start button repeatedly until the display shows .
3. Touch the Start/Pause button again to start the programme immediately

## Changing the delay start after the countdown has started

To change the delay start

1. Touch the Start/Pause button to pause the appliance. The related indicator flashes.
2. Touch the Delay Start button repeatedly until the display shows the desired delay time.
3. Touch the Start/Pause button again to start the new countdown.

## The ProSense load detection





The program duration in the display is referred to a medium/high load.

After touching the Start/Pause button, the maximum declared load indicator goes off, the indicator



flashes, the ProSense starts the laundry load detection:

1. The appliance detects the load in the first 30 seconds: the indicator **kg** and the time dots  flash, the drum rotates shortly.
2. At the end of the load detection, the indicator **kg** goes off and the time dots  stop flashing. The programme duration will be adjusted accordingly and could increase or decrease. After further 30 seconds, the water filling starts.

At the end of the load detection, in case of drum overload, the indicator **MAX** is flashing in the display: In this case, for 30 seconds, it is possible to pause the appliance and remove the exceeding garments. Once removed the exceeding garments, touch the Start/Pause button to start the program again. The ProSense phase can be repeated up to three times (see point 1).

**Important!** If the laundry amount will not be reduced, the washing program starts anyway, despite the overload. In this case, it will be not possible to guarantee the best washing results.



About 20 minutes after the program start, the program duration could be adjusted again depending on the capacity of water absorption of the fabrics.



The ProSense detection is carried out with complete washing programs only (no skipping phase selected).

## Program phase indicators

When the program starts the indicator of the running phase flashes and the other phase indicators are steady on.



E.g. the washing or pre wash phase is running

When the phase ends the relevant indicator stops flashing and is steady on. The next phase indicator starts flashing.



E.g. the rinse phase is running:

If you select the Plus Steam the steam phase indicators come on.



The steam phase is running:



The anti-crease phase is running:

## Interrupting a program and changing the options

When the program is running, you can change only some options:

1. Touch the Start/Pause button. The related indicator flashes.
2. Change the options. The given information in the display changes accordingly.
3. Touch the Start/Pause button again. The washing programme continues.

## Cancelling a running program

1. Press the On/Off button to cancel the programme and to deactivate the appliance.
2. Press the On/Off button again to activate the appliance.

Now, you can set a new washing program.



If the ProSense phase is already carried out and the water filling is already started, the new program starts without repeating the ProSense phase. The water and the detergent are not drained out in order to avoid waste. The display shows the maximum duration of the program, updating it about 20 minutes after the starting of the new program.

## Opening the door - Adding garments

While a program or the delay start operates, the appliance door is locked.



If the temperature and level of the water in the drum are too high and/or the drum still rotates you cannot open the door.

1. Touch the Start/Pause button. In the display the related door lock indicator goes off.
2. Open the appliance door. If necessary, add or remove the items.
3. Close the door and touch the Start/ Pause button. The program or the delay start continues.
4. The door can be opened when the program is complete, or set spinning or draining program/ option and than press Start/Pause button.

## End of the program

When the program has finished, the appliance stops automatically. The acoustic signals operate (if they are active). In the display all washing phase indicators become steady and the time area shows .

The indicator of the Start/Pause button goes off.

The door unlocks and the indicator  goes off.

1. Press the On/Off button to deactivate the appliance. After five minutes from the end of the program, the energy saving function automatically deactivates the appliance.









When you activate the appliance again, the display show the end of the last selected program. Turn the program dial to set a new cycle.



2. Remove the laundry from the appliance.
3. Make sure that the drum is empty.
4. Keep the door and the detergent dispenser slightly ajar to prevent mildew and odours.
5. Close the water tap.

## Draining water out after end of cycle

If you have chosen a program or an option that does not empty out the water of the last rinse, the program is completed, but:

- The display shows the indicator , the option indicator  or  and the door locked indicator . The indicator of the running phase  flashes.
- The drum still turns at regular intervals to prevent the creases in the laundry.
- The door stays locked
- You must drain the water to open the door:
  1. If necessary, touch the Spin button to decrease the spin speed proposed by the appliance.
  2. Touch the Start/Pause button:

- If you have set , the appliance drains the water and spins.
- If you have set , the appliance only drains the water.

The option indicator  or  goes off, while the indicator  flashes and then goes off.

3. When the programme is completed and the door locked indicator  goes off, you can open the door.
4. Press the On/Off button a few seconds to deactivate the appliance.



In any case, the appliance empties the water out automatically after approximately 18 hours.

## Stand-by option

The Stand-by function automatically deactivates the appliance to decrease the energy consumption when:

## HINTS AND TIPS

**WARNING!** Refer to Safety chapters.

## The laundry load

- Divide the laundry into: white, coloured, synthetics, delicates and wool.
- Follow the washing instructions on the laundry care labels.
- Do not wash white and coloured items together.

- Some coloured items can discolour with the first wash. We recommend that you wash them separately for the first couple of times.
- Turn multilayered fabrics, wool and items with printed illustrations inside out.
- Pre-treat stubborn stains.
- Wash stubborn stains with a special detergent.
- Be careful with curtains. Remove the hooks and put the curtains in a washing bag or pillowcase.
- Do not wash laundry without hems or with cuts. Use a washing bag to wash small and/or delicate items (e.g. underwired bras, belts, tights, shoelaces, ribbons, etc. ).
- A very small load can cause balance problems with the spin phase leading to excessive vibration. If this occurs:
  - a. interrupt the programme and open the door (refer to "Daily Use" chapter);
  - b. manually redistribute the load so that the items are spaced evenly around the tub;
  - c. press the Start/Pause button. The spin phase continues.
    - Button up pillowcases, close zippers, hooks and poppers. Tie up belts, cords, shoelaces, ribbons and any other loose elements.
    - Do not wash laundry without hems or with cuts. Use a washing bag to wash small and/or delicate items (e.g. underwired bras, belts, tights, etc. ).

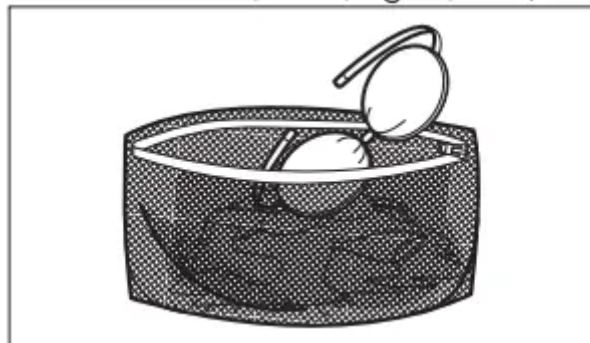

- Empty pockets and unfold the items.

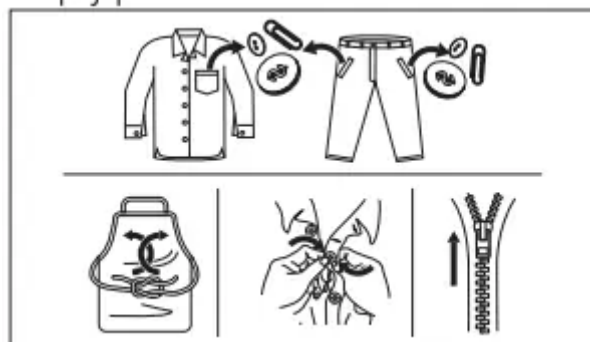

# CARE AND CLEANING

## External cleaning

Clean the appliance with mild soap and warm water only. Fully dry all the surfaces. Do not use a scouring pads or any scratching material.

**CAUTION!** Do not use alcohol, solvents or chemical products.

**CAUTION!** Do not clean the metal surfaces with chlorine-based detergent.

## Descaling



If the water hardness in your area is high or moderate, we recommend that you use a water descaling product for washing machines.

Regularly examine the drum to check for limescale.

The regular detergents already contain water softening agents, but we recommend to run a cycle with empty drum and a descaling product occasionally.



Always follow the instructions that you find on the packaging of the product.

## Maintenance wash

The repeated and prolonged use of low temperature programs can cause detergent deposits, fluff residues, bacterial growth inside the drum and the tub. This could generate bad odours and mildew. To eliminate these deposits and hygienize the inner part of the appliance, run a maintenance wash regularly (at least once a month):

1. Remove all laundry from the drum.
2. Run a cotton program with the highest temperature without detergent.

## Door seal

This appliance is designed with a self cleaning draining system, allowing light fluff fibers that fall off the clothes to be drained out with the water. Regularly examine the seal. Coins, buttons, other small items can be recovered at the end of the cycle.

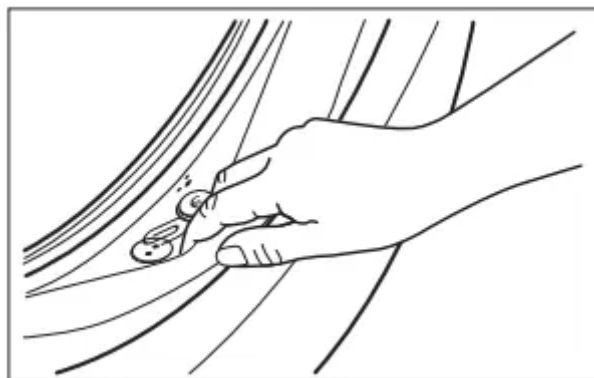

Clean it when needed, using ammonia cream cleanser agent without scratching the seal surface.



Always obey the instructions that you find on the packaging of the product.

### **Cleaning the drum**

Regularly examine the drum to prevent unwanted deposits. Rust deposits in the drum may occur due to rusting foreign body in the washing or tap water containing iron. Clean the drum with special products for stainless steel.



Always follow the instructions that you find on the packaging of the product. Do not clean the drum with acidic descaling products, scouring products containing chlorine or iron or steel.

#### **For a thorough clean:**

1. Clean the drum with special products for stainless steel.



Always follow the instructions that you find on the packaging of the product.

2. Run a cotton program with the highest temperature without detergent

### **Cleaning the detergent dispenser**

To prevent possible deposits of dried detergent or clotted fabric softener and/or formation of mould in the detergent dispenser drawer, once in a while carry out the following cleaning procedure:

1. Open the drawer. Press the catch downwards as indicated in the picture and pull it out.

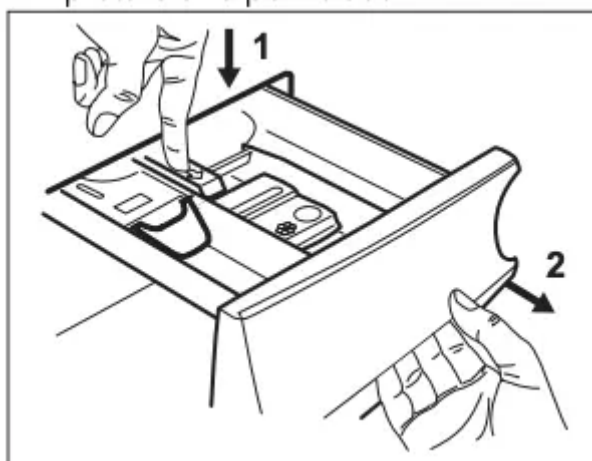

2. Remove the top part of the additive compartment to aid cleaning. Make sure that all detergent residue is removed from the upper and lower part of the recess. Use a small brush to clean the recess.

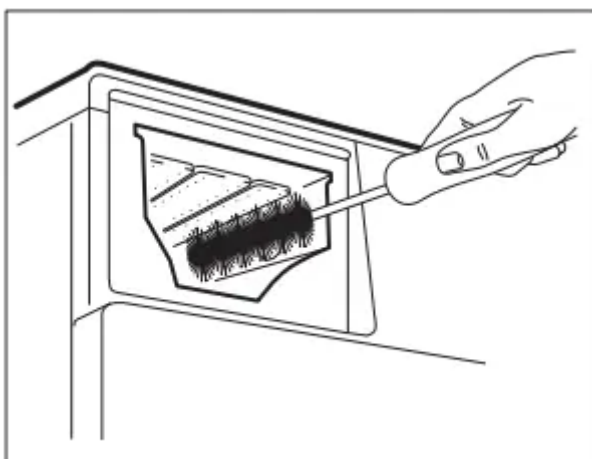
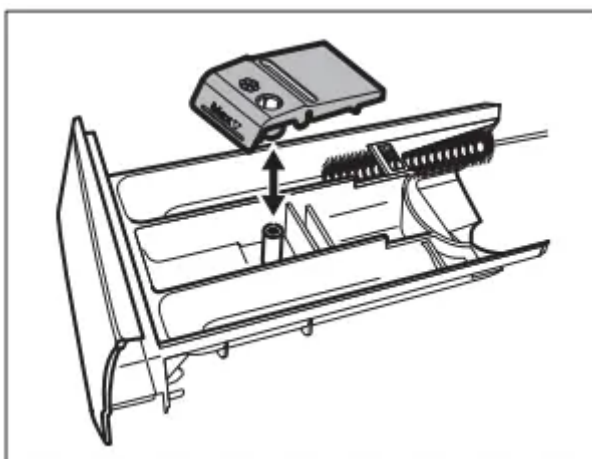

3. Flush the detergent drawer out under running warm water to remove any traces of accumulated detergent. After cleaning, replace the top part in its position.

4. Insert the detergent drawer into the guide rails and close it. Run the rinsing program without any clothes in the drum.

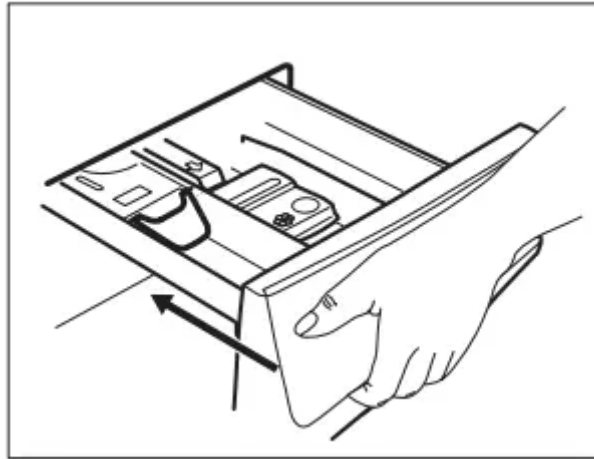

## Cleaning the drain pump

**WARNING!** Disconnect the mains plug from the mains socket.



Regularly check the drain pump filter and make sure that it is clean.

Clean the drain pump if:

- The appliance does not drain the water.
- The drum does not turn.
- The appliance makes an unusual noise because of the blockage of the drain pump.
- The display shows the alarm code E20

### **WARNING!**

- Do not remove the filter while the appliance operates.
- Do not clean the pump if the water in the appliance is hot. Wait until the water cools down

**Proceed as follows to clean the pump:**

1. Open the pump cover.

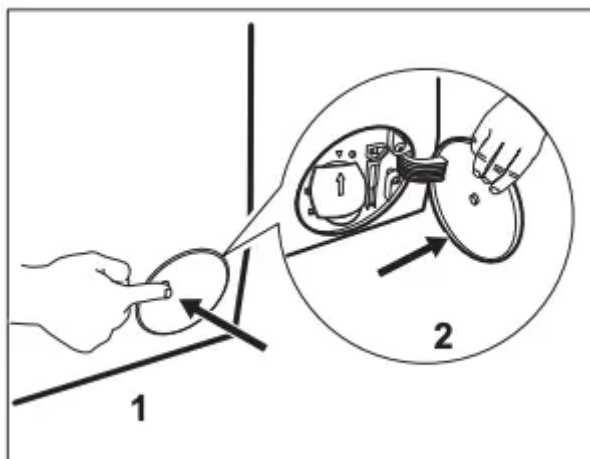

2. Place a suitable bowl below the drain pump access to collect the water that flows out.
3. Open the chute downwards. Always keep a rag nearby to dry up any water spillages when removing the filter.

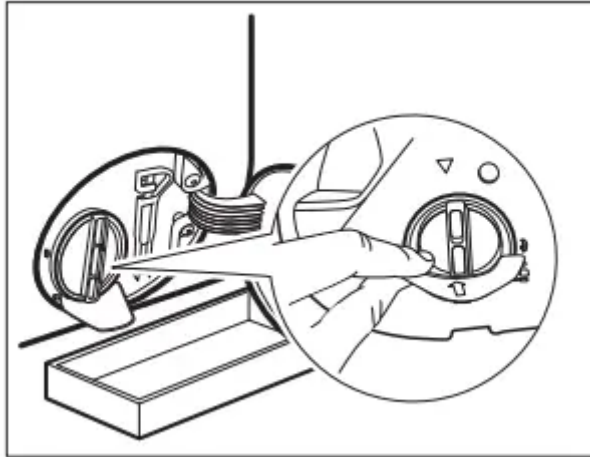

4. Turn the filter 180 degrees in anticlockwise direction to open it, without removing. Let the water flow out.

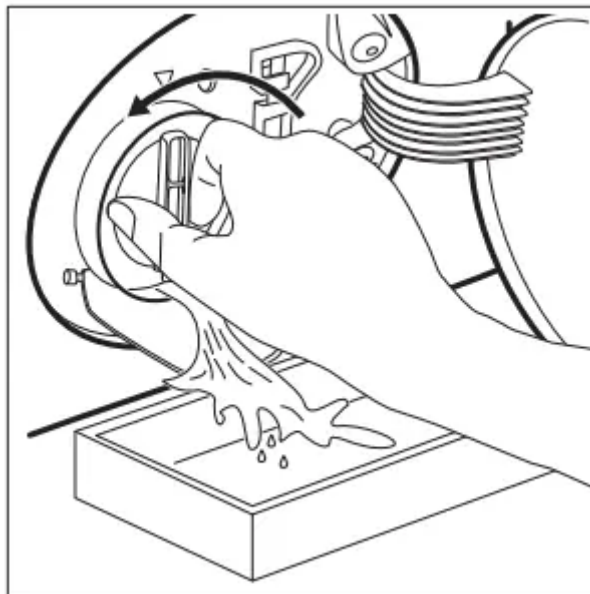

5. When the bowl is full of water, turn the filter back and empty the container.
6. Repeat the steps 4 and 5 until the water stops to flow out.
7. Turn the filter anti-clockwise to remove it.

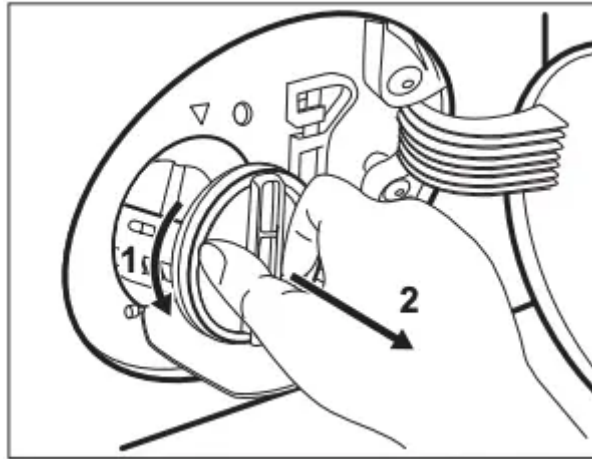

8. If it is necessary, remove fluff and objects from the filter recess.

9. Make sure that the impeller of the pump can rotate. If it does not rotate, contact the Authorised Service Centre.

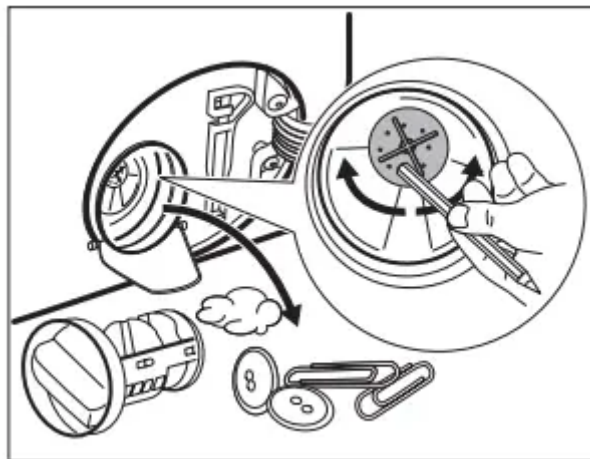

10. Clean the filter under the water tap

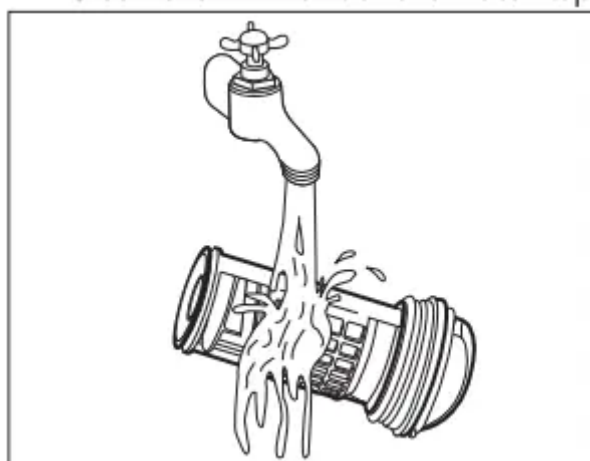

11. Put the filter back into the special guides by turning it clockwise. Make sure that you tighten the filter correctly to prevent leakages.

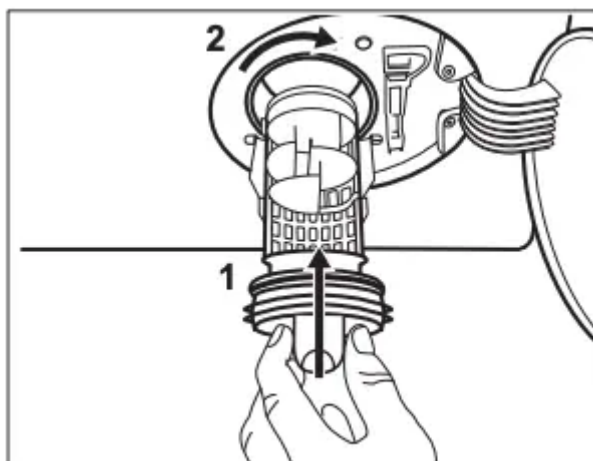

12. Close the pump cover.

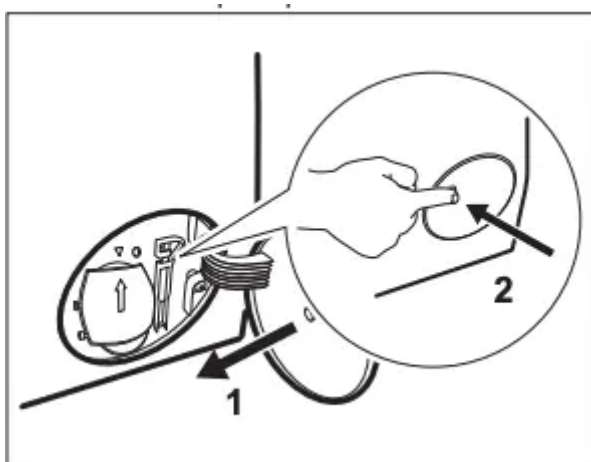

When you drain the water with the emergency drain procedure, you must activate the drain system again:

- a. Put 2 litres of water in the main wash compartment of the detergent dispenser.
- b. Start the programme to drain the water.

### **Cleaning the inlet hose and the valve filter**

It is recommended to clean both the filters of the inlet hose and valve occasionally to remove any deposit, collected over the time:

1. Remove the inlet hose from the tap and clean the filter

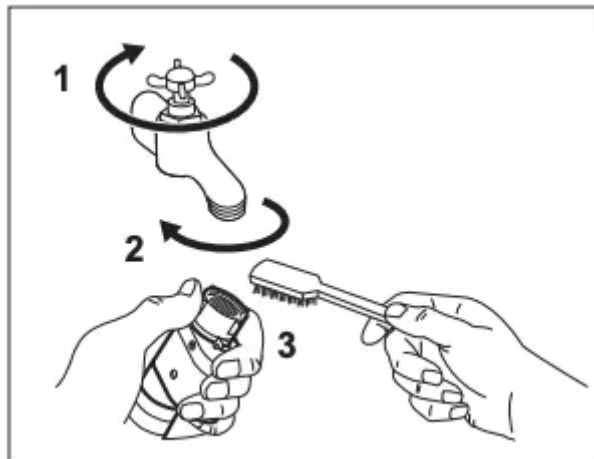

2. Remove the inlet hose from the appliance by loosening the ring nut.

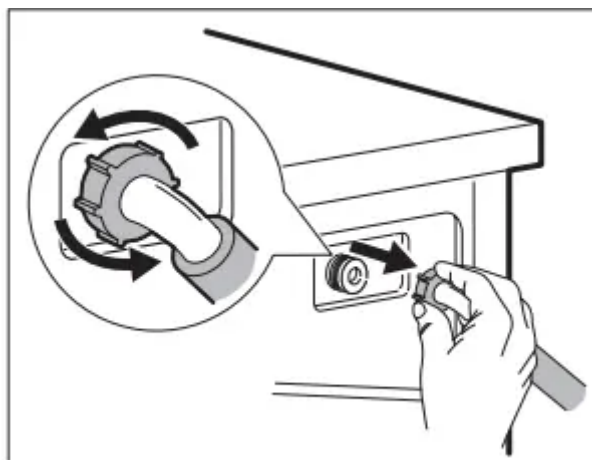

3. Clean the valve filter on the back of the appliance with a toothbrush.

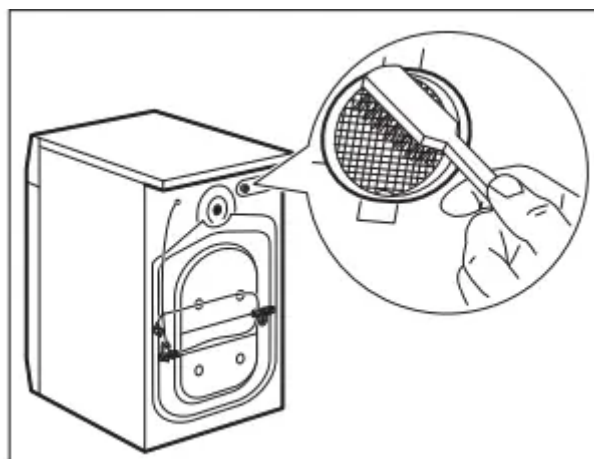

4. When you reconnect the hose to the back of the appliance, turn it left or right (not in vertical position) depending on the position of your water tap.

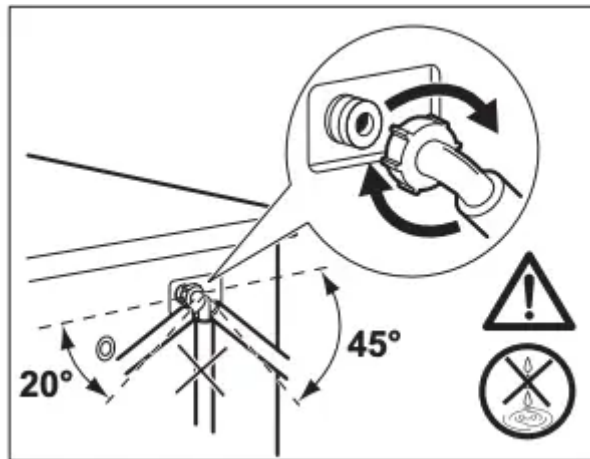

## TROUBLESHOOTING

**WARNING!** Refer to Safety chapters.

### Emergency drain

If the appliance cannot drain the water, carry out the same procedure, described in 'Cleaning the drain pump' paragraph. If necessary, clean the pump.

When you drain the water with the emergency drain procedure, you must activate the drain system again:

1. Put 2 litres of water in the main wash compartment of the detergent dispenser.
2. Start the programme to drain the water.

### Frost precautions

If the appliance is installed in an area where the temperature can reach the values around 0° C or drop below, remove the remaining water from the inlet hose and the drain pump.

1. Disconnect the mains plug from the mains socket.
2. Close the water tap.
3. Put the two ends of the inlet hose in a container and let the water flow out of the hose.
4. Empty the drain pump. Refer to the emergency drain procedure.
5. When the drain pump is empty, install the inlet hose again.

**WARNING!** Make sure that the temperature is higher than 0 °C before you use the appliance again. The manufacturer is not responsible for damages caused by low temperatures.

### Introduction

The appliance does not start or it stops during operation. First try to find a solution to the problem (refer to the table). If the problem persists, contact the Authorised Service Centre.

In case of major problems, the acoustic signals operate, the display shows an alarm code and the Start/Pause button may flash continuously:

- **E10** - The appliance does not fill with water properly. Start the appliance again by pressing Start/Pause button. After 5 seconds the door will be unlocked.
- **E20** - The appliance does not drain the water.
- **E40** - The appliance door is open or not closed correctly. Please check the door!



If the appliance is overloaded, remove some items from the drum and/or keep pressed the door while touching the Start/Pause button until the indicator  stops flashing (see the picture below).

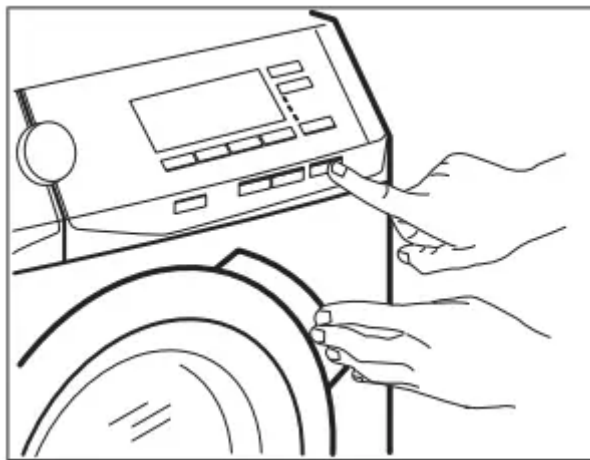

- **EH0** - The mains supply is unstable. Wait until the mains supply is stable.
- **E91** - No communication between electronic elements of the appliance. Switch it off and switch on again. The programme was not finished properly or the appliance stopped too early. If the alarm code appears again, contact the Authorised Service Centre.
- **EF0** - The anti-flood device is on. Disconnect the appliance and close the water tap. Contact the Authorised Service Centre.

**WARNING!** Deactivate the appliance before carrying out any check.

## Possible failures

Problem	Possible solution
<p><b>The program does not start.</b></p>	<ul style="list-style-type: none"> <li>• Make sure that the mains plug is connected to the mains socket.</li> <li>• Make sure that the appliance door is closed.</li> <li>• Make sure that there is no damaged fuse in the fuse box.</li> <li>• Make sure that the Start/Pause has been touched.</li> <li>• If the delay start is set, cancel the setting or wait for the end of countdown.</li> <li>• Deactivate the Child Lock function if it is on.</li> </ul>
<p><b>The appliance does not fill with water properly</b></p>	<ul style="list-style-type: none"> <li>• Make sure that the water tap is open.</li> <li>• Make sure that the pressure of the water supply is not too low. For this information, contact your local water authority.</li> <li>• Make sure that the water tap is not clogged.</li> <li>• Make sure that the inlet hose has no kinks, damages or bends.</li> <li>• Make sure that the connection of the water inlet hose is correct.</li> <li>• Make sure that the filter of the inlet hose and the filter of the valve are not clogged. Refer to "Care and cleaning".</li> </ul>
<p><b>The appliance fills with water and drains immediately</b></p>	<ul style="list-style-type: none"> <li>• Make sure that the drain hose is in the correct position. The hose may be positioned too low. Refer to "Installation instruction".</li> </ul>
<p><b>The appliance does not drain the water.</b></p>	<ul style="list-style-type: none"> <li>• Make sure that the sink spigot is not clogged.</li> <li>• Make sure that the drain hose has no kinks or bends.</li> <li>• Make sure that the drain filter is not clogged. Clean the filter, if necessary. Refer to "Care and cleaning".</li> <li>• Make sure that the connection of the drain hose is correct.</li> <li>• Set the drain program if you set a program without drain phase.</li> <li>• Set the drain program if you set an option which ends with water in the tub.</li> </ul>

<p><b>The spin phase does not operate or the washing cycle lasts longer than usual.</b></p>	<ul style="list-style-type: none"> <li>• Set the spin program.</li> <li>• Make sure that the drain filter is not clogged. Clean the filter, if necessary. Refer to "Care and cleaning".</li> <li>• Adjust manually the items in the tub and start the spin phase again. This problem may be caused by balance problems.</li> </ul>
<p><b>There is water on the floor.</b></p>	<ul style="list-style-type: none"> <li>• Make sure that the couplings of the water hoses are tight and there is not water leakages.</li> <li>• Make sure that the water inlet hose and the drain hose have no damages.</li> <li>• Make sure you use the correct detergent and the correct quantity of it.</li> <li>• Too much detergent or unsuitable detergent creates too much foam. Reduce detergent quantity and/or use a suitable detergent.</li> </ul>
<p><b>You cannot open the appliance door.</b></p>	<ul style="list-style-type: none"> <li>• Make sure that a washing program that ends with water in tub, has been selected.</li> <li>• Make sure that the washing program is finished.</li> <li>• Set the drain or the spin program if there is water in the drum.</li> <li>• Make sure that the appliance receives electrical power.</li> <li>• This problem may be caused by a failure of the appliance. Contact the Authorised Service Centre. If you need to open the door, please read carefully "Emergency door opening".</li> </ul>
<p><b>The appliance makes an unusual noise and vibrates.</b></p>	<ul style="list-style-type: none"> <li>• Make sure the levelling of the appliance is correct. Refer to "Installation instruction".</li> <li>• Make sure that the packaging and/or the transit bolts are removed. Refer to "Installation instruction".</li> <li>• Add more laundry in the drum. The load may be too small.</li> </ul>
<p><b>The program duration increases or decreases during program execution.</b></p>	<ul style="list-style-type: none"> <li>• The ProSense function is able to adjust the program duration according to the type and the laundry load size.</li> </ul>

	Refer to "The ProSense load detection" in "Daily Use" chapter.
<b>The washing results are not satisfactory.</b>	<ul style="list-style-type: none"> <li>• Increase the detergent quantity or use a different detergent.</li> <li>• Use special products to remove the stubborn stains before you wash the laundry.</li> <li>• Make sure that you set the correct temperature.</li> <li>• Decrease the laundry load.</li> </ul>
<b>Too much foam in the drum during the washing cycle.</b>	<ul style="list-style-type: none"> <li>• Reduce the quantity of detergent.</li> <li>• Too much detergent or unsuitable detergent has been used. Reduce detergent quantity and/or use correct detergent.</li> </ul>
<b>After the washing cycle, there are some detergent residues in the dispenser drawer.</b>	<ul style="list-style-type: none"> <li>• Make sure that the flap is in the correct position (UP for powder detergent - DOWN for liquid detergent).</li> <li>• Make sure you have used the detergent dispenser according the indications given in this user manual.</li> </ul>

After the check, activate the appliance. The program continues from the point of interruption. If the problem occurs again, contact the Authorised Service Centre. If the display shows other alarm codes. Deactivate and activate the appliance. If the problem continues, contact the Authorised Service Centre.

## Emergency door opening

In case of power failure or functioning failure the appliance door remains locked. The washing program continues when the power is restored. If the door remains locked in case of failure, it is possible to open it using the emergency unlock function.

Before opening the door:

**CAUTION!** Risk of burns! Make sure that the water temperature is not too high and the laundry is not hot. If necessary, wait until they cool down.

**CAUTION!** Risk of injury! Make sure that the drum is not rotating. If necessary, wait until the drum stops rotating.



Make sure that the water level inside the drum is not too high. If necessary, proceed with an emergency drain (refer to «Emergency drain» in «Care and cleaning» chapter).

To open the door, proceed as follows:

1. Press the On/Off button to switch the appliance off.
2. Disconnect the mains plug from the mains socket.
3. Open the filter flap.
4. Pull the emergency unlock trigger downward once. Pull it downward once again, keep it tensed and, in the meanwhile, open the appliance door.

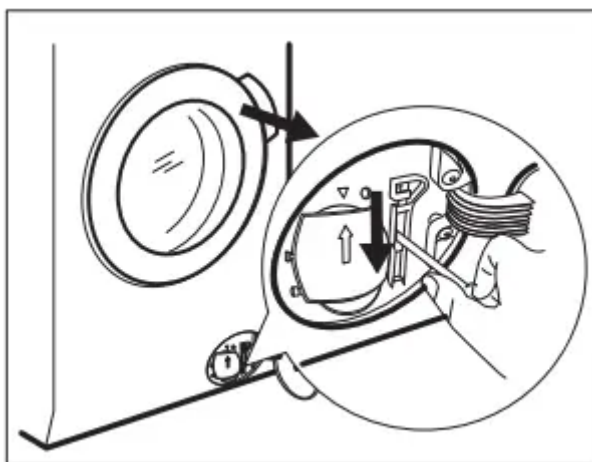

5. Take out the laundry and then close the appliance door.
6. Close the filter flap.

### **Warning**

This content is compiled from multiple sources and is provided for reference purposes only. It may not be complete or fully applicable to all situations. If you are unable to resolve your issue, please contact the product manufacturer or an authorized service provider for official support.