

## Preparing

### Lifting and moving the TV

When moving or lifting the TV, read the following to prevent the TV from being scratched or damaged and for safe transportation regardless of its type and size.

- It is recommended to move the TV in the box or packing material that the TV originally came in.
- Before moving or lifting the TV, disconnect the power cord and all cables.
- When holding the TV, the screen should face away from you to avoid damage.



- Hold the side and bottom of the TV frame firmly. Make sure not to hold the transparent part, speaker, or speaker grill area.

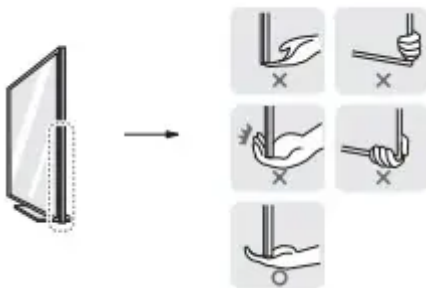

- Use at least two people to move a large TV.
- When transporting the TV by hand, hold the TV as shown in the following illustration.

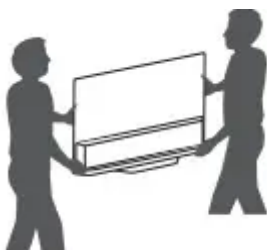

- When transporting the TV, do not expose the TV to jolts or excessive vibration.
- When transporting the TV, keep the TV upright; never turn the TV on its side or tilt towards the left or right.
- When handling the TV, be careful not to damage the protruding buttons.

## Mounting on the Table

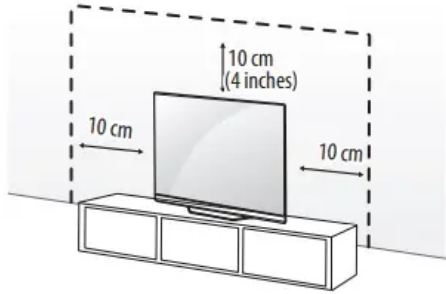
<p>1 Lift and tilt the TV into its upright position on a table.</p> <ul style="list-style-type: none"><li>• Leave a minimum of 10 cm (4 inches) space from the wall for proper ventilation.</li></ul> <p>2 Connect the power cord to a wall outlet.</p>	 <p>(Depending upon model)</p>
---	--

## Warning

- Do not apply foreign substances (oils, lubricants, etc.) to the screw parts when assembling the product. (Doing so may damage the product.)
- If you install the TV on a stand, you need to take actions to prevent the product from overturning. Otherwise, the product may fall over, which may cause injury.
- Do not use any unapproved items to ensure the safety and lifespan of the product.
- Any damages or injuries by using unapproved items are not covered by the warranty.
- Make sure that the screws are fastened tightly. (If they are not fastened securely enough, the TV may tilt forward after being installed.)
- Do not fasten the screws with excessive force otherwise they may strip and become loose.

## Securing TV to the Wall

1 Insert and tighten the eye-bolts, or TV brackets and bolts on the back of the TV.

- If there are bolts inserted at the eye-bolts position, remove the bolts first.

2 Mount the wall brackets with the bolts to the wall. Match the location of the wall bracket and the eye-bolts on the rear of the TV.

3 Connect the eye-bolts and wall brackets tightly with a sturdy rope or cable. Make sure to keep the rope parallel to the flat surface.

- Use a platform or cabinet that is strong and large enough to support the TV securely.
- Brackets, bolts and ropes are optional. You can obtain additional accessories from your local dealer.

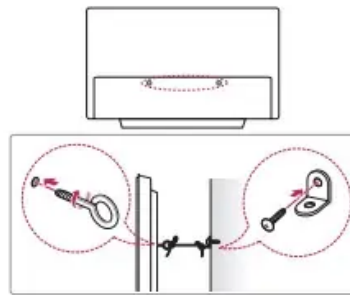

(Depending upon model)

## Mounting to the Wall

An optional wall mount can be used with your LG Television. Consult with your local dealer for a wall mount that supports the VESA standard used by your TV model. Carefully attach the wall mount bracket at the rear of the TV. Install the wall mount bracket on a solid wall perpendicular to the floor. If you are attaching the TV to other building materials, please contact qualified personnel to install the wall mount. Detailed instructions will be included with the wall mount. We recommend that you use an LG brand wall mount. The LG wall mount is easy to adjust or to connect the cables. When you do not use LG's wall mount bracket, use a wall mount bracket where the device is adequately secured to the wall with enough space to allow connectivity to external devices. If you are using a non-adjustable mount, attach the mount to the wall. Attach the cables to the TV first, then attach the TV to the mount.

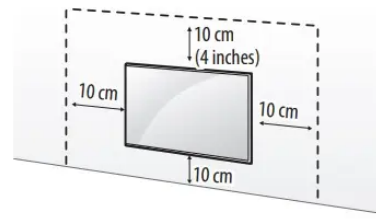

(Depending upon model)

## Warning

- Remove the stand before installing the TV on a wall mount by performing the stand attachment in reverse.
- For more information of screws and wall mount bracket, refer to the Separate Purchase.
- If you intend to mount the product to a wall, attach VESA standard mounting interface (optional parts) to the back of the product. When you install the set to use the wall mounting bracket (optional parts), fix it carefully so as not to drop.
- When mounting a TV on the wall, make sure not to install the TV by hanging the power and signal cables on the back of the TV.
- Do not install this product on a wall if it could be exposed to oil or oil mist. This may damage the product and cause it to fall.
- Please use the accessory cable holder when hanging on the wall. (Only OLED48/55/65/77/83C1\*)

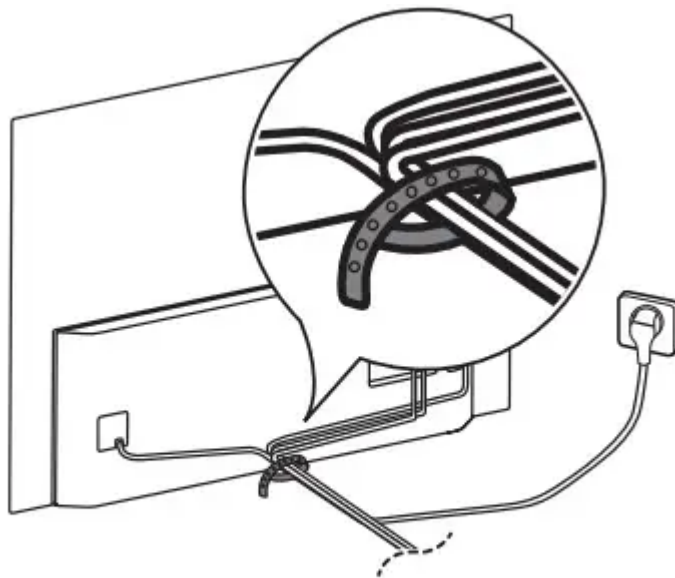

(Depending upon model)

### Wall Mounting Bracket

(Depending upon model)

Make sure to use screws and wall mount bracket that meet the VESA standard. Standard dimensions for the wall mount kits are described in the following table.

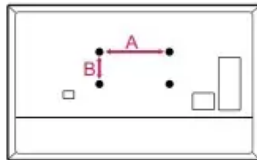

Model	OLED48/55/65A1* OLED55/65B1* OLED48/55/65C1*	OLED77A1* OLED77B1* OLED77C1*	OLED83C1*
VESA (A x B) (mm)	300 x 200	400 x 200	400 x 400
Standard screw	M6	M6	M6
Number of screws	4	4	4
Wall mount bracket	OLW480B	OLW480B	LSW440B

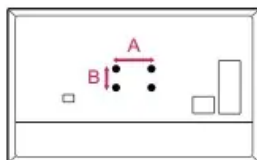

Model	OLED83C1*
Screws distance (A x B) (mm)	180 x 55
Wall mount bracket	WB21EB

## Antenna/Cable

Connect an antenna, cable, or cable box to watch TV while referring to the following. The illustrations may differ from the actual items and an RF cable is optional.

- Make sure not to bend the copper wire of the RF cable.

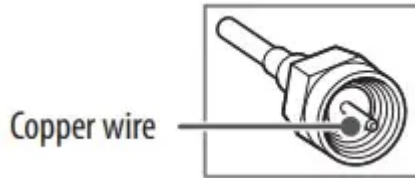

- Complete all connections between devices, and then connect the power cord to the power outlet to prevent damage to your TV.
- Use a signal splitter to use 2 TVs or more.
- DTV Audio Supported Codec: MPEG, Dolby Digital
- This TV cannot receive Ultra HD (3840 x 2160 pixels) broadcasts directly because the related standards have not been confirmed.

## Starting TV

### Turning on the TV

You can simply operate the TV functions, using the button.

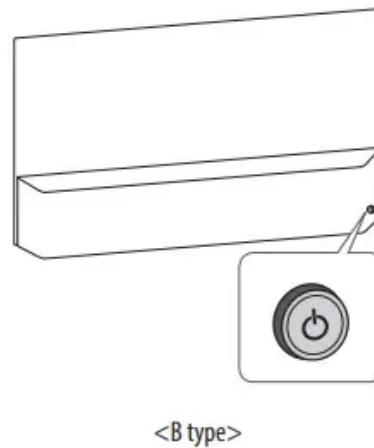
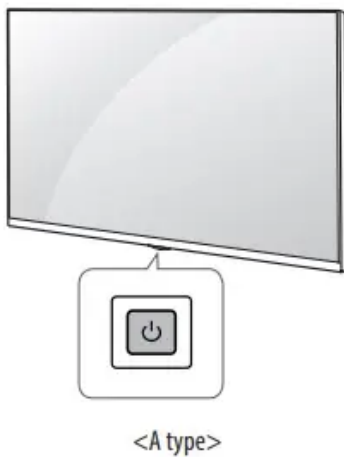



### Using button



<A Type >

Power On (Press)	1) All running apps will close.
Power Off1) (Press and Hold)	2) You can access and adjust the menu by pressing the button when TV is on.
Menu Control (Press2))	3) You can use the function when you access menu control.
Menu Selection (Press and Hold3))	

<B Type >

	Power On (Press) Power Off 1) (Press and hold)	1) All running apps will close.
	Volume Control	
	Channels Control	

### Inserting the battery

<p>When the message [Magic Remote battery is low. Please change the battery.] is displayed, replace the batteries.</p> <p>To install batteries, open the battery cover, replace batteries (1.5 V AA) matching the  and  ends to the label inside the compartment, and close the battery cover. To remove the batteries, perform the installation actions in reverse.</p>	
--	--

### Warning

- Do not mix new batteries with old batteries. This may cause the batteries to overheat and leak.
- Failure to match the correct polarities of the battery may cause the battery to burst or leak, resulting in fire, personal injury, or ambient pollution.

- This apparatus uses batteries. In your community there might be regulations that require you to dispose of these batteries properly due to environmental considerations. Please contact your local authorities for disposal or recycling information.
- Batteries inside or inside the product shall not be exposed to excessive heat such as sunshine, fire or the like.

# Using Remote Control

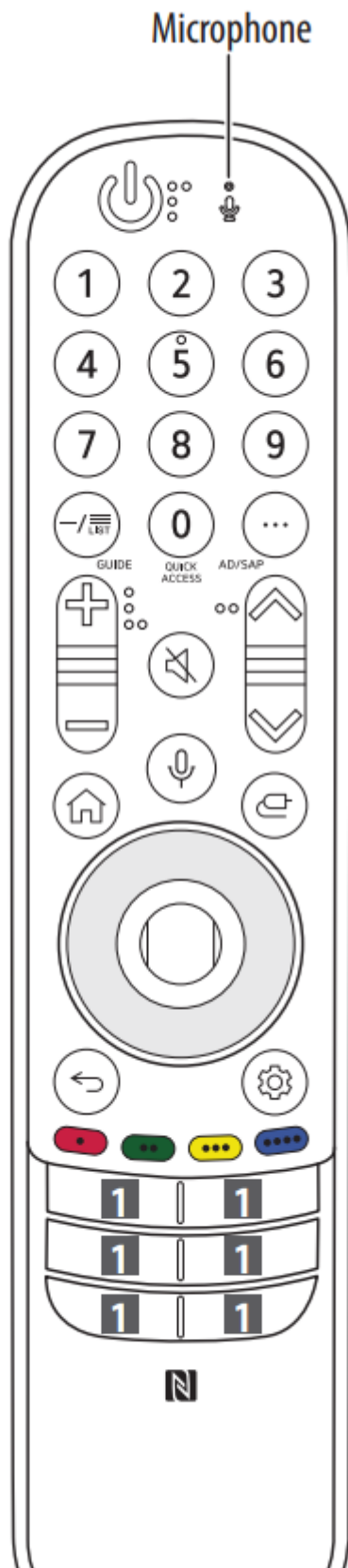



**Power** Turns the TV on or off.



**— (Dash)** Inserts a — between numbers such as 2-1 and 2-2.



**LIST** Accesses the saved channel list.

**GUIDE\*\***

Accesses the [Guide].

**QUICK \*\*  
ACCESS**

Accesses the [Edit Quick Access].

- [Edit Quick Access] is a feature that allows you to enter a specified app or Live TV directly by pressing and holding the number buttons.



**Volume buttons** Adjusts the volume level.



**Channel buttons** Scrolls through the saved channels.



**Home** Accesses the Home menu.



**Home** Launches the last used apps.





**Input** Changes the input source.



**Input** Accesses the [Home Dashboard].



**Wheel (OK)** Press the center of  button to select a menu. You can change channels by using  button.











**Wheel (OK)** Accesses the [Magic Explorer]. You can run the [Magic Explorer] feature when the pointer colour is changed to purple. If watching a channel, press and hold down the pointer onto the video. When using [TV Guide], [Settings], [Sports Alert], or [Art Gallery], press and hold down on the text.



**Back** Returns to the previous level.



**Back** Clears on-screen displays and returns to last input viewing.

-  **9** <sup>\*\*</sup> **Number buttons** Enters numbers.
-  **More actions** Displays more remote control functions.
- AD/SAP** <sup>\*\*</sup> SAP (Secondary Audio Program) feature can also be enabled by pressing the **•••** button.
-  **Mute** Mutes all sounds.
-  **Mute** <sup>\*\*</sup> Accesses the [Accessibility] menu.
-  **Voice recognition** Network connection is required to use the voice recognition function.  
 Check for recommended content. (Some recommended services may not be available in some countries.)
-  **Voice recognition** <sup>\*\*</sup> Speak while pressing and holding the button to use the voice recognition feature.
-  **Q. Settings** Accesses the Quick Settings.
-  **Q. Settings** <sup>\*\*</sup> Displays the [All Settings] menu.



**Up/Down/Left/Right** Press the up, down, left or right button to scroll the menu. If you press  buttons while the pointer is in use, the pointer will disappear from the screen and Magic Remote will operate like a general remote control. To display the pointer on the screen again, shake Magic Remote to the left and right.



These access special functions in some menus.

**1**

**Streaming Service buttons** Connects to the Video Streaming Service.

(Some buttons and services may not be provided depending upon models or regions.)

# Troubleshooting

<p>Cannot control the TV with the remote control.</p>	<ul style="list-style-type: none"> <li>• Check if anything such as tape has been placed over the receiver.</li> <li>• Check if there is any obstacle between the product and the remote control.</li> <li>• Replace the batteries with new fresh ones.</li> </ul>
<p>No image display and no sound is produced.</p>	<ul style="list-style-type: none"> <li>• Check if the product is turned on.</li> <li>• Check if the power cord is connected to a wall outlet.</li> <li>• Check if there is a problem in the wall outlet by connecting other products.</li> </ul>
<p>The TV turns off suddenly.</p>	<ul style="list-style-type: none"> <li>• Check the power control settings. The power supply may be interrupted.</li> <li>• Check if the auto-off function is activated in the settings menu.</li> <li>• If there is no signal while the TV is on, the TV will turn off automatically after 15 minutes of inactivity.</li> </ul>
<p>Abnormal Display</p>	<ul style="list-style-type: none"> <li>• If the TV feels cold to the touch, there may be a small flicker when it is turned on. This is normal; there is nothing wrong with TV. Some minute dot defects may be visible on the screen, appearing as tiny red, green, or blue spots. However, they have no adverse effect on the TV's performance. Avoid touching the screen or holding your finger(s) against it for long periods of time. Doing so may produce some temporary distortion effects on the screen.</li> <li>• This panel is an advanced product that contains millions of pixels. In a very few cases, you could see fine dots on the screen while you're viewing the TV. Those dots are deactivated pixels and do not affect the performance and reliability of the TV.</li> </ul>
<p>Generated Sound</p>	<ul style="list-style-type: none"> <li>• Cracking noise A cracking noise that occurs when watching or turning off the TV is generated by plastic thermal contraction due to temperature and humidity. This noise is common for products where thermal deformation is required.</li> </ul>



- Electrical circuit humming/panel buzzing A low level noise is generated from a high-speed switching circuit, which supplies a large amount of current to operate a product. It varies depending upon the product. This generated sound does not affect the performance and reliability of the product.

#### Warning

- Make sure to wring any excess water or cleaner from the cloth
- Do not spray water or cleaner directly onto the TV screen.
- Make sure to spray just enough of water or cleaner onto a dry cloth to wipe the screen.

## Specifications

Product specifications may be changed without prior notice due to upgrade of product functions.

Estimated yearly energy consumption indicated on the FTC label is measured in accordance with the Test Procedures for Television Sets (USA only). The actual energy consumption depends on the usage environment (The content watched, TV settings, etc.).

- For information of the power supply and power consumption, refer to the label attached to the product.
- The typical power consumption is measured in accordance with IEC 62087 or each country's energy regulations.
  - \* On some models, the label is inside the external device connection terminal cover.
  - \* Depending upon the model or country, the typical power consumption may not be on label.

Broadcasting Specifications	
Television system	ATSC / NTSC-M, 64 & 256 QAM
Channel coverage (Band)	VHF 2-13, UHF 14-69, DTV 2-69, CATV 1-135, CADTV 1-135
External antenna impedance	75 Ω

Wireless module(LGSBWAC95)Specifications	
Wireless LAN (IEEE 802.11a/b/g/n/ac)	
Frequency range	Output Power (Max.)
2,400 to 2,483.5 MHz	18.5 dBm
5,150 to 5,725 MHz	18 dBm
5,725 to 5,850 MHz	18 dBm
Bluetooth	
Frequency range	Output power(Max.)
2,400 to 2,483.5 MHz	9 dBm

As band channels can vary per country, the user cannot change or adjust the operating frequency. This product is configured for the regional frequency table.

For consideration of the user, this device should be installed and operated with a minimum distance of 20 cm between the device and the body.

FCC ID: BEJLGSBWAC95 / IC: 2703H-LGSBWAC95

Environment condition	
Operating Temperature	0 °C to 40 °C (32 °F to 104 °F)
Operating Humidity	Less than 80 %
Storage Temperature	-20 °C to 60 °C (-4 °F to 140 °F)
Storage Humidity	Less than 85 %

### Warning

This content is compiled from multiple sources and is provided for reference purposes only. It may not be complete or fully applicable to all situations. If you are unable to resolve your issue, please contact the product manufacturer or an authorized service provider for official support.