

SAFETY INSTRUCTIONS IMPORTANT SAFEGUARDS

- **Use, maintenance and product installation guidelines: for your own safety, please read through all paragraphs of the instruction manual including the associated pictograms.**
- This appliance is intended for indoor, domestic household use only. It is not intended to be used in the following applications, and the guarantee will not apply for:
 - staff kitchen areas in shops, offices and other working environments;
 - farm houses;
 - by clients in hotels, motels and other residential type environments;
 - bed and breakfast type environments.
- Before first use remove all packaging materials, stickers and accessories from the inside and the outside of the appliance.
- This appliance is not intended for use by persons (including children) with reduced physical, sensory or mental capabilities, or lack of experience and knowledge, unless they have been given supervision or instruction concerning use of the appliance by an adult responsible for their safety. Children should be supervised to ensure that they do not play with the appliance.
- This appliance can be used by children aged from 8 years and above and persons with reduced physical, sensory or mental capabilities or lack of experience and knowledge if they have been given supervision or instruction concerning use of the appliance in a safe way and understand the hazards involved. Cleaning and user maintenance shall not be made by children unless they are older than 8 and supervised.
- Keep the appliance and its cord out of reach of children less than 8 years.

Never leave the appliance unattended when in use.

-  Accessible surface temperatures can be high when the appliance is operating. Never touch the hot surfaces of the appliance.
- This appliance is not intended to be operated by means of an external timer or separate remote-control system.
- Fully unwind the power cord before plugging in the appliance. If the power supply cord is damaged, it must be replaced by the manufacturer or its after sales service in order to avoid any danger. Do not use an extension lead. If you accept liability for doing so, only use an extension lead which is in good condition, has a plug with an earth

connection and is suited to the power rating of the appliance. Take all necessary precautions to prevent anyone tripping over an extension cord.

- Always plug the appliance into an earthed socket.
- Make sure that the electric power supply is compatible with the power rating and voltage indicated on the bottom of the appliance.
- Use a sponge, hot water and washing up liquid to clean the cooking plates.
- Never immerse the appliance, its power cord or plug in water or any other liquid.

Do

- Read the instructions carefully, common to different versions depending on the accessories supplied with your appliance, and keep them within reach.
- If an accident occurs, rinse the burn immediately with cold water and call a doctor if necessary.
- Before first use, wash the plates (see paragraph 5), pour a little cooking oil onto the plates and wipe with a soft cloth or paper kitchen towel.
- Position the power cord carefully, whether an extension is used or not, so that guests can move freely around the table without tripping over it.
- Cooking fumes may be dangerous for animals which have a particularly sensitive respiratory system, such as birds. We advise bird owners to keep them away from the cooking area.
- Always keep the appliance out of the reach of children.
- Check that both faces of the plate are clean before use.
- To prevent damage to the plates, only use them on the appliance for which they were designed (e.g., do not place in an oven, on the gas ring or electric hot-plate, etc.).
- Ensure that the plates are stable, well positioned and correctly clipped to the appliance. Only use the plates provided with the appliance or bought from an Approved Service Centre.
- Always use a wooden or plastic spatula to avoid damaging the cooking plates.
- Only use parts or accessories provided with the appliance or bought from an Approved Service Centre. Do not use them for other appliances or intention.

Do not

- Do not use the appliance outside.
- Never leave the appliance unattended when plugged in or in use.
- To prevent the appliance from overheating, do not place it in a corner or below a wall cupboard.

- Never place the appliance directly on a fragile surface (glass table, tablecloth, varnished furniture, etc.) or on a soft surface such as a tea-towel.
- Never place the appliance under a cupboard attached to a wall or a shelf or next to inflammable materials such as blinds, curtains or wall hangings.
- Never place the appliance on or near hot or slippery surfaces; the power cord must never be close to or in contact with hot parts of the appliance, close to a source of heat or resting on sharp edges.
- Do not place cooking utensils on the cooking surfaces of the appliance.
- Never cut food directly on the plates,
- Do not use metal scouring pads, abrasive wire wool or harsh scouring powder as this may damage the non-stick coating.
- Do not move the appliance when in use.
- Do not carry the appliance by the handle or metallic wires.
- Never run the appliance empty.
- Do not use aluminium foil or other objects between the plate and the food being cooked.
- Do not remove the grease collection tray while cooking. If the grease collection tray becomes full when cooking: let the appliance cool down before emptying.
- Do not place the hot plate on a fragile surface or under water.
- To preserve the non-stick properties of the coating, avoid excessive pre-heating with the appliance empty. The plates should never be handled when hot.
- Do not cook food in aluminium foil.
- To avoid spoiling your appliance, do not use flambe recipes in connection with it at any time.
- Do not place a sheet of aluminum or any other object between the plates and the heating element.
- Never heat or cook whilst the grill is open.
- Never heat up the appliance without the cooking plates.

Tips/information

- Thank you for buying this appliance, which is intended for domestic use only.
- For your safety, this appliance complies with the applicable standards and regulations - Low voltage directive - Electromagnetic compatibility - The environment - Materials in contact with food.
- On first use, there may be a slight odour and a little smoke during the first few minutes.
- Our company has an ongoing policy of research and development and may modify these products without prior notice.

- Do not consume foodstuff that comes into contact with the parts marked with logo.
- If the food is too thick, the safety system will stop the appliance from working.

Description

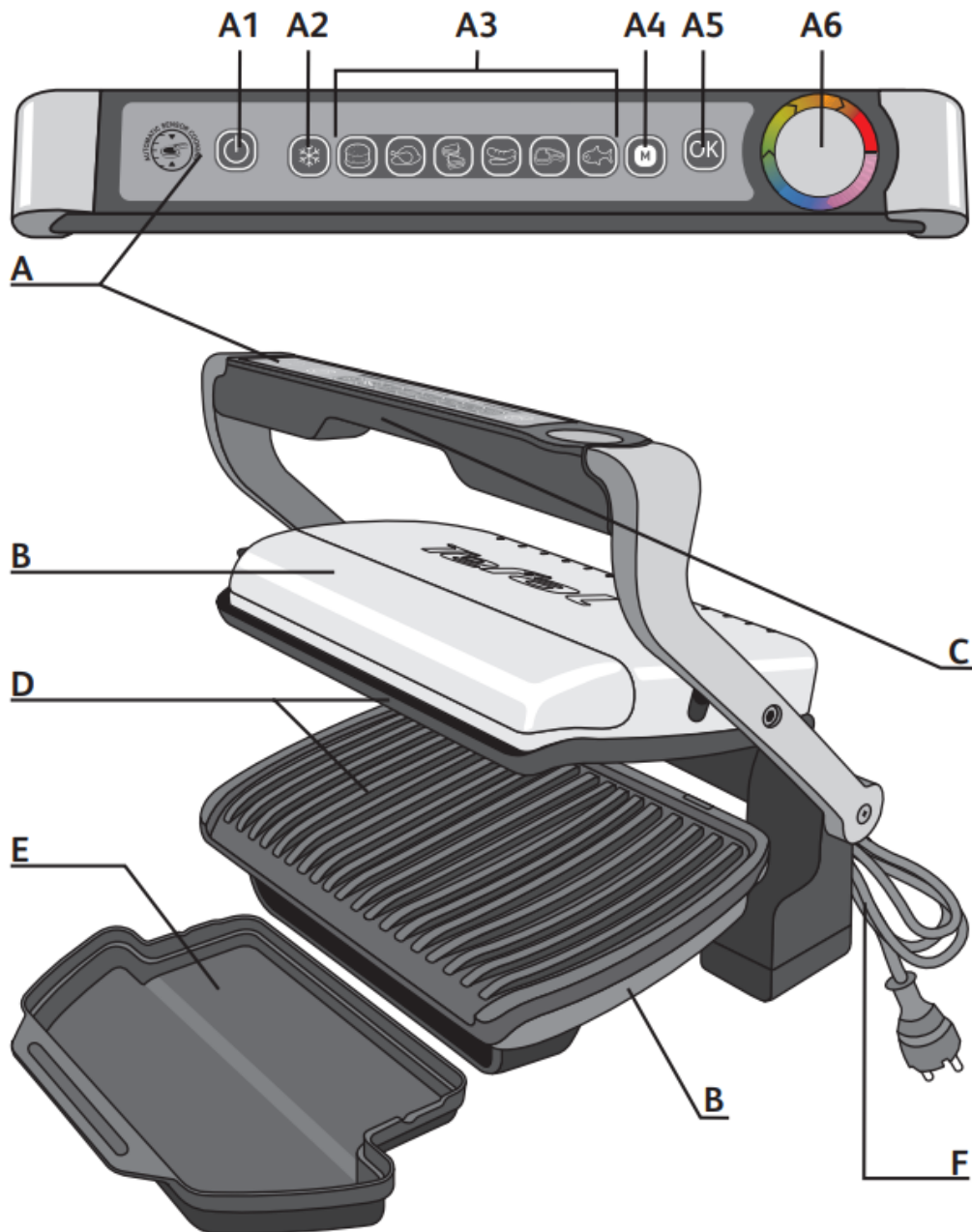

A Control panel

A1 On/off button

A2 Frozen food mode

A3 Cooking programs

A4 Manual mode

- A5 OK button
- A6 Cooking level indicator
- B Body
- C Handle
- D Cooking plates
- E Juice collection tray
- F Power cord

“Guide to LED colours”

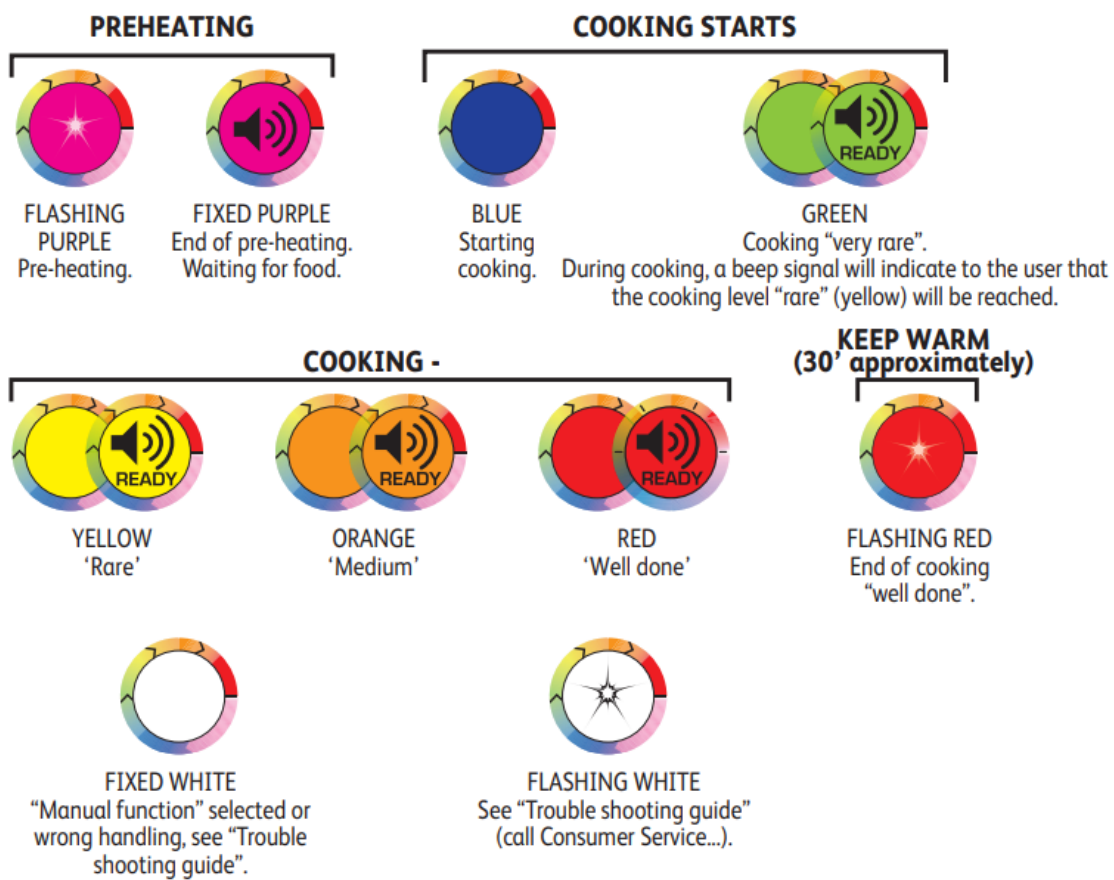

Guide to cooking programs



Burger



Panini



Manual mode:
Traditional grill
for manual
operation

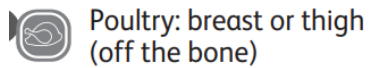

Poultry: breast or thigh
(off the bone)



Fish:
salmon fillet

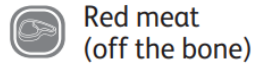

Red meat
(off the bone)



Sausage

NOTE: Maximum thickness of food 4 cm and minimum thickness of food 4mm for all cooking programs and manual mode.

1 Setting up

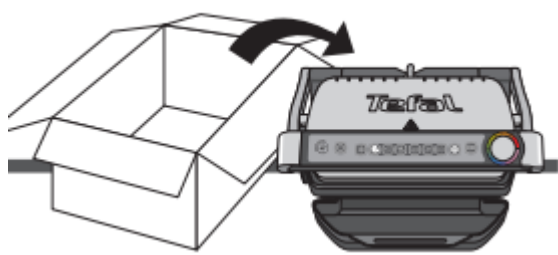

1 Remove all packaging materials, stickers and accessories from the inside and the outside of the appliance.

The colour sticker on the cooking level indicator can be changed, according to the language. You can replace it with the one on the inside of the packaging.

2 Before using for the first time, thoroughly clean the plates with warm water and a little washing-up liquid, rinse and dry thoroughly.

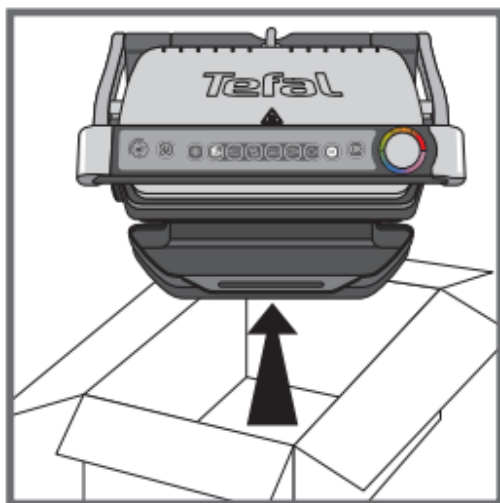

1



2

3-4 Position the removable juice collection tray at the front of the appliance.



3

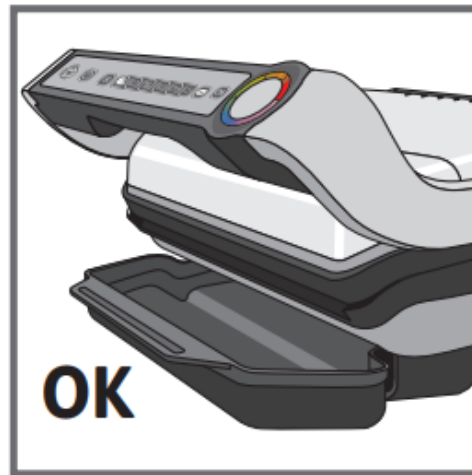

4

2 Pre-heating

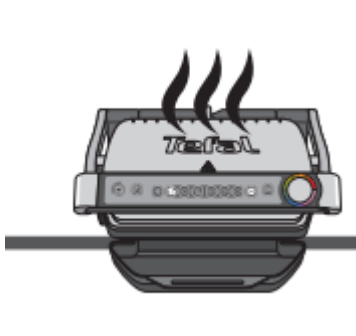

5 If desired for the best results you may wipe the cooking plates using a paper towel dipped in a little cooking oil, to improve the non-stick release.

6 Remove any surplus oil using a clean kitchen paper towel

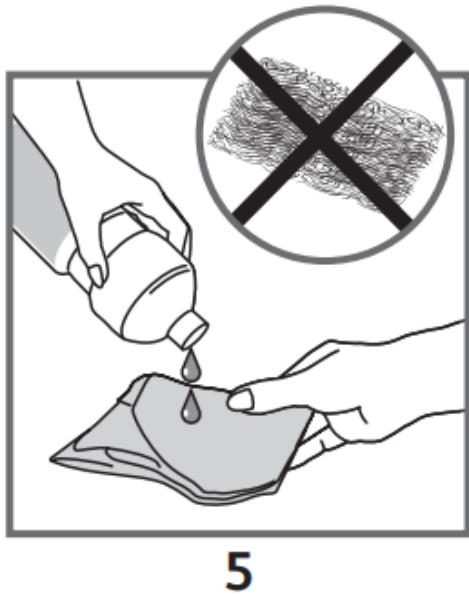

7 Connect the appliance to the mains. (note the cord should be fully unwound).

Close the grill.

8 Press the On/Off button.

Note: It is normal for the program lights to illuminate in succession until a program has been selected.

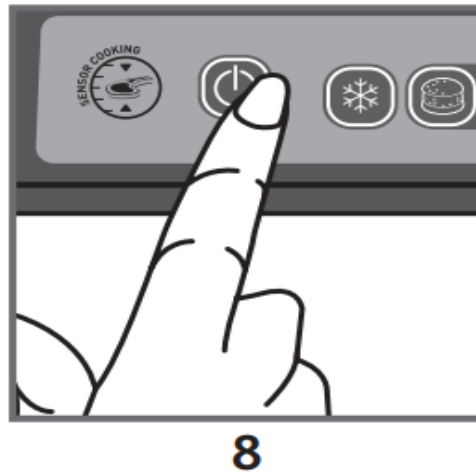
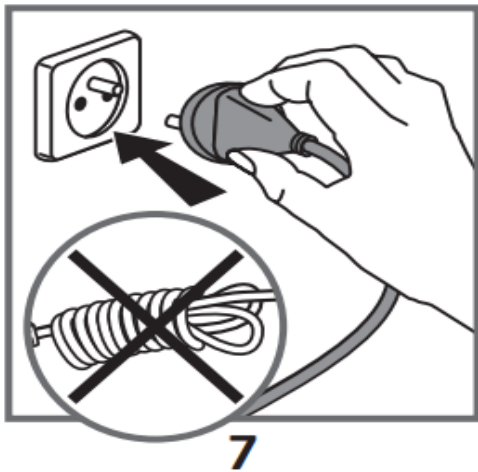

9 If the food that you wish to cook is frozen, press the button "frozen food". The cooking time will then be adjusted automatically to allow for this.

10 Select the appropriate cooking mode according to what type of food you wish to cook.

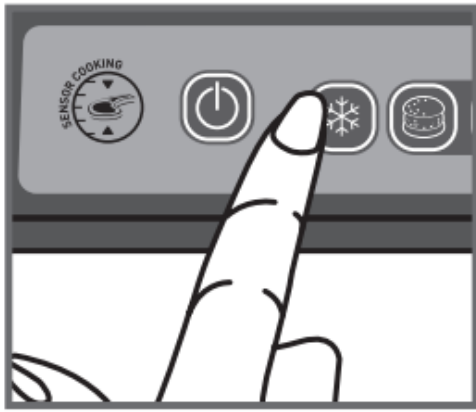



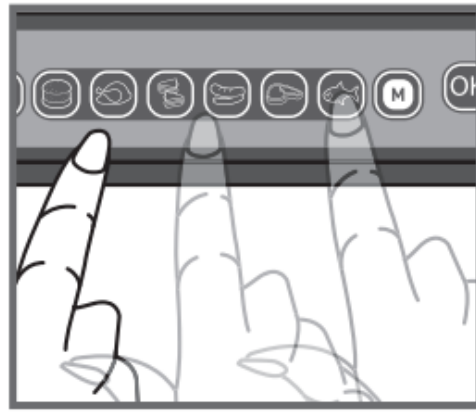



9



10

6 cooking programs and a manual mode

	<p>Select this cooking program if you want to cook burgers.</p>		<p>Select this cooking program if you want to cook red meat : steak (off the bone)</p>
	<p>Select this cooking program if you want to cook poultry (off the bone): thigh, breast, escalope</p>		<p>Select this cooking program if you want to cook fish: salmon steak</p>
	<p>Select this cooking program if you want to cook paninis*</p>		
	<p>Select this cooking program if you want to cook sausage</p>		<p>If you select Manual Mode, after the pre heating phase and once the food is added, the indicator light is a fixed white after closing the lid. You must then control the cooking time manually.</p>

			Note: With Manual mode there are no audible beeps and the cooking level indicator does not change colour.
--	--	--	---

*For meat less than 4 mm thickness, after preheating the grill and closing the lid, press OK to ensure the appliance recognises the food and that the cooking cycle starts.

If you are uncertain about what cooking mode to use for other foods because it is not listed above, please refer to the “Cooking table for out of program food” page 55.

11 Press the “OK” button: the appliance starts pre-heating and the cooking level indicator flashes purple.

NB: If you have selected the wrong program, return to stage 8.

12 Wait for 4-7 minutes.

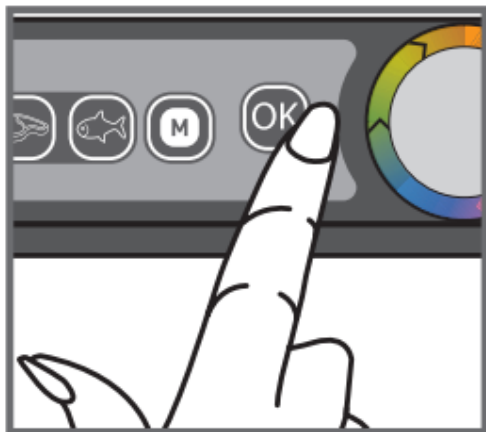

11

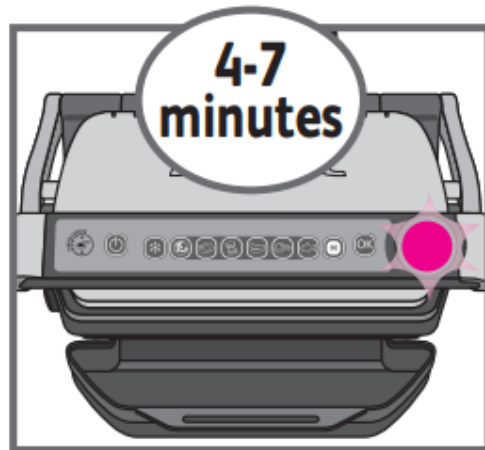

12

13 An audible tone is heard and the cooking level indicator stops flashing purple when the pre-heating mode is complete. Comments: At the end of pre-heating, if the appliance remains closed, the safety system will turn off the product.

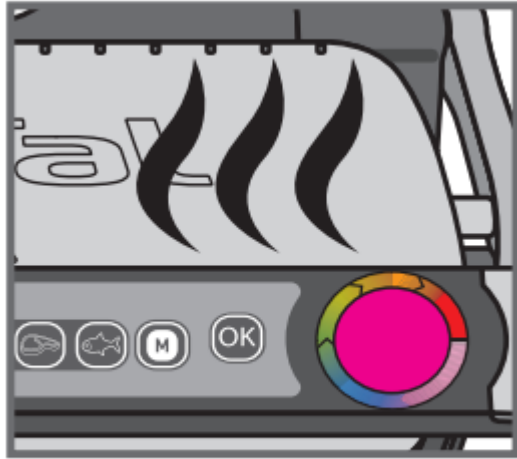

13

3 Cooking using Dedicated Programs

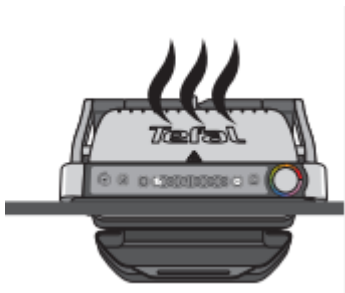

14-15 After pre-heating, the appliance is ready for use.

Open the grill and place the food on the cooking plate.

Note: To ensure correct operation of the automatic sensor you must open the lid fully.

Comments: If the appliance remains open for too long, the safety system will turn off the appliance automatically.



14

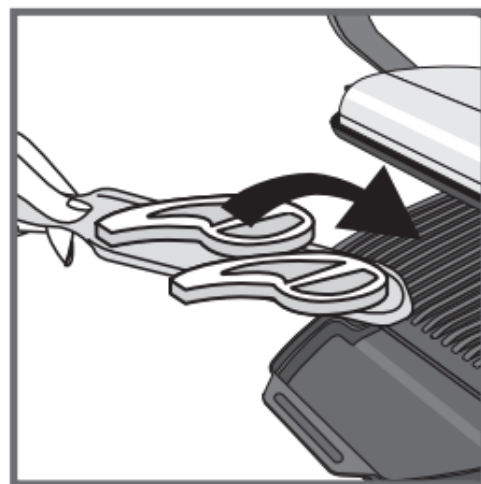

15

16-17 The appliance automatically adjusts the cooking cycle (time and temperature) according to the food thickness and quantity.



16



17

Close the appliance to start the cooking cycle. The cooking level indicator turns blue and then becomes green to indicate the cooking is in progress (for the best results do not open or move your food during the cooking process).

During the cooking in progress stage, a beep sounds at each stage of cooking to warn the user that a cooking level (eg rare/yellow) has been reached. Note for very thin pieces of food: close the appliance, the button OK will flashing and the indicator will stay “fixed purple”, press OK to ensure the appliance recognises the food and that the cooking cycle starts.

18 According to the degree of cooking, the indicator light changes colour. When the indicator light is yellow with a beep, your food is rare, when the indicator light is orange with a beep, your food is medium and when the indicator light is red, your food is well done.

N.B.: if you like your meat very rare, remove the meat when the cooking level indicator turns green.
Please note, especially for meat, it is normal that cooking results may vary depending on type, quality and origin of food.

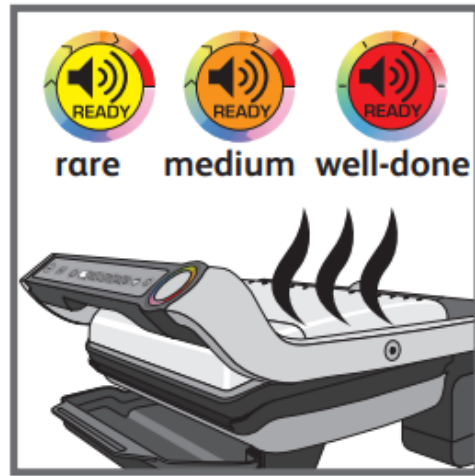

18

19 - 20 When the colour of the cooking level indicator (A6) corresponds to the degree of cooking you require, open the appliance and remove the food.



19

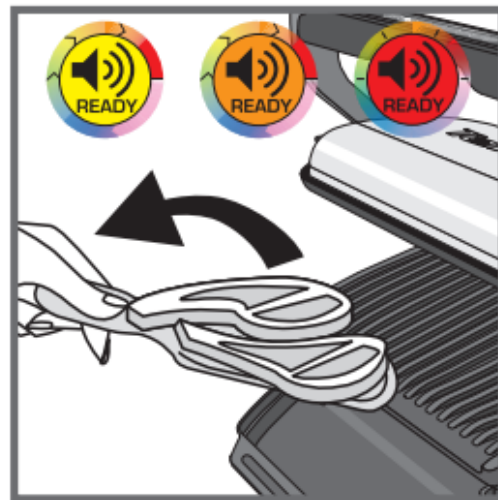

20

4 Comments



21 Close the appliance. The control panel will light up and set itself to 'choice of program' mode.



21

Comment: the security system will turn off automatically if no program selection is made.

How to cook another batch of food: After finishing your first batch of food:

1. Make sure the appliance is closed with no food inside.
2. Select the appropriate cooking mode/program (this step is necessary even if you decide to pick the same cooking mode than for the previous batch of food).
3. Press the "OK" button: the appliance starts pre-heating. The preheating is symbolized by the cooking level indicator that flashes purple.
4. The pre-heating is complete when an audible beep is heard and the cooking level indicator stops flashing purple.
5. After the pre-heating, the appliance is ready for use. Open the grill and place the food inside the appliance.

Important:

- Please note that any new batch of food, the pre-heating phase is mandatory. Remember to always have the grill closed and no food inside in order for the pre-heating to effectively function.
- Then wait for the pre-heating to be complete before opening the grill and place the food inside.

N.B.: if the new pre-heating cycle is carried out immediately after the end of the preceding cycle, the preheating time will be reduced.

22-23-24

Cook the food according to your personal taste (except for cooking food under 4 mm thick where the cooking cycle has been started by pressing 'OK')

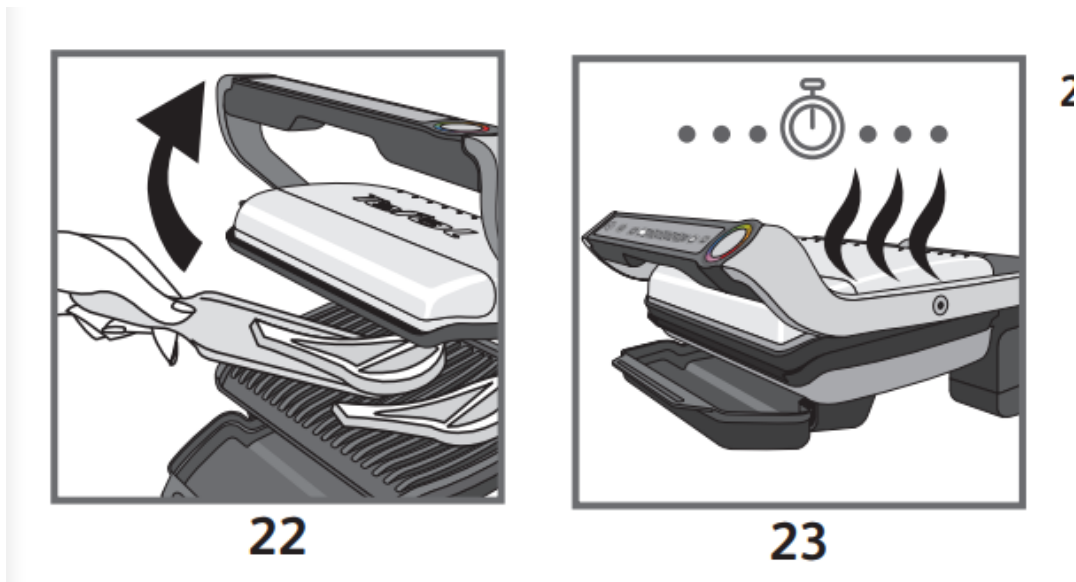

If you want to cook food to different personal tastes, once you have placed it on the grill, open the lid and remove the food when it has reached the desired level and then close the grill and continue cooking the other food. The program will continue its cooking cycle until it reaches the 'well done' level.



24

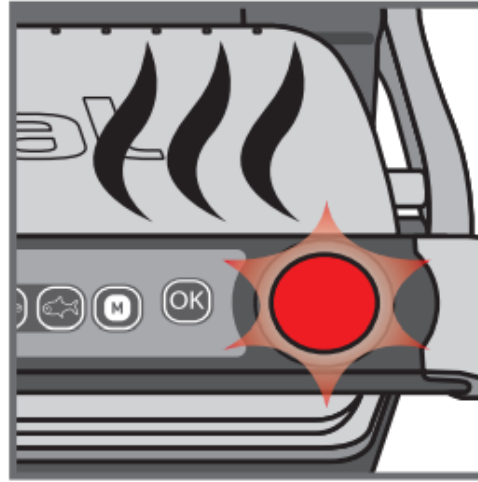

25

25 Keeping warm function

When the cooking process has finished, the appliance will start the keep warm function; the indicator will switch to flashing red and will emit a beep signal every 20 seconds. If the food is left on the grill, it will continue cooking while the cooking plates cool down and during the keeping warm function. You can turn of the beep signal by pressing the 'OK' button. Comment: the safety system will turn the appliance off automatically after a certain amount of time.

5 Cleaning and maintenance

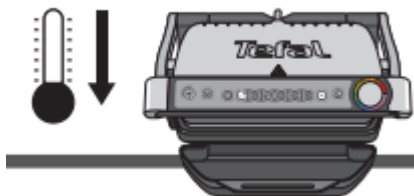

26 Press the ON/OFF button.

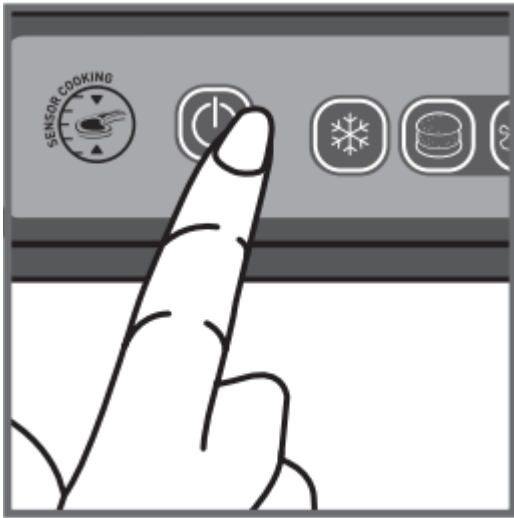

26

27 Unplug grill from wall outlet

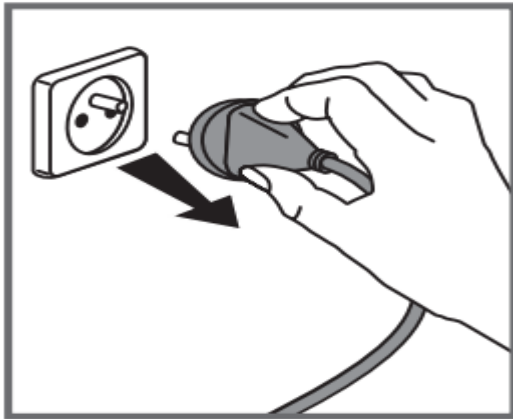

27

28 Allow to cool for at least 2 hours with the lid closed.

To avoid accidental burns, allow grill to cool thoroughly before cleaning.

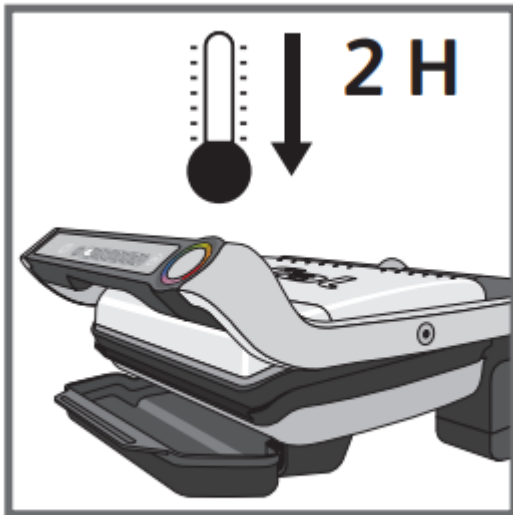

28

29 Before cleaning, unlock and remove the plates to avoid damaging the cooking surface.

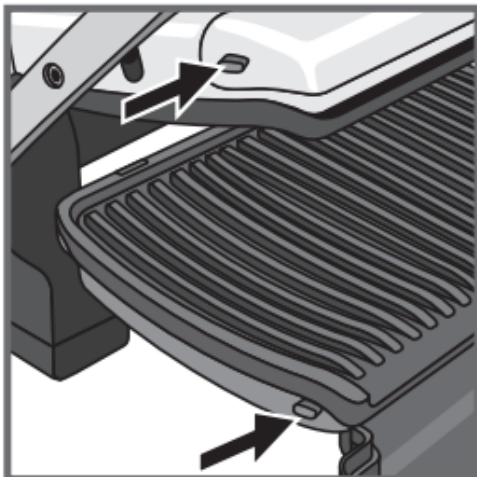

29

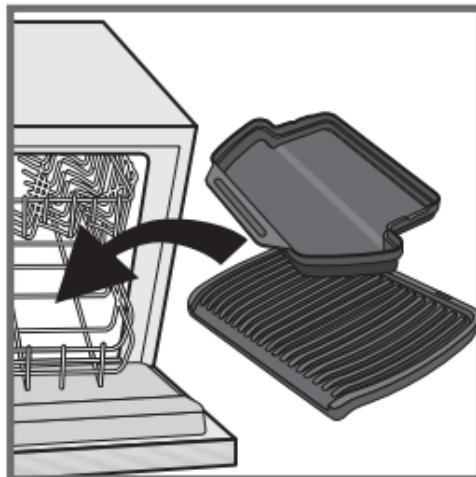

30

30 The juice collection tray and the cooking plates are dishwasher safe. The appliance and its cord cannot be placed in the dishwasher.

The heating elements, visible and accessible parts, should not be cleaned after removing the plates. If they are very dirty, wait until the appliance has completely cooled down and clean them with a dry cloth.

Note: After cleaning the upper and lower plates should be re-fitted in their original positions and are not interchangeable.

6 Cleaning

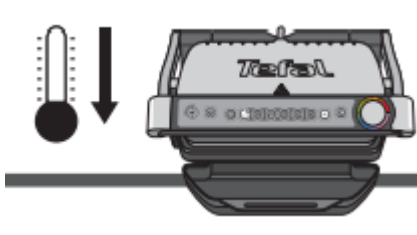

31-32 If you do not use a dishwasher, you can use warm water and a little washing-up liquid to clean the cooking plates, then rinse thoroughly to remove any residue. Dry carefully with a paper towel or dry soft cloth. Do not use metallic scouring pads, steel wool or any abrasive cleaners to clean any part of the grill, only use nylon or non-metallic cleaning sponges.

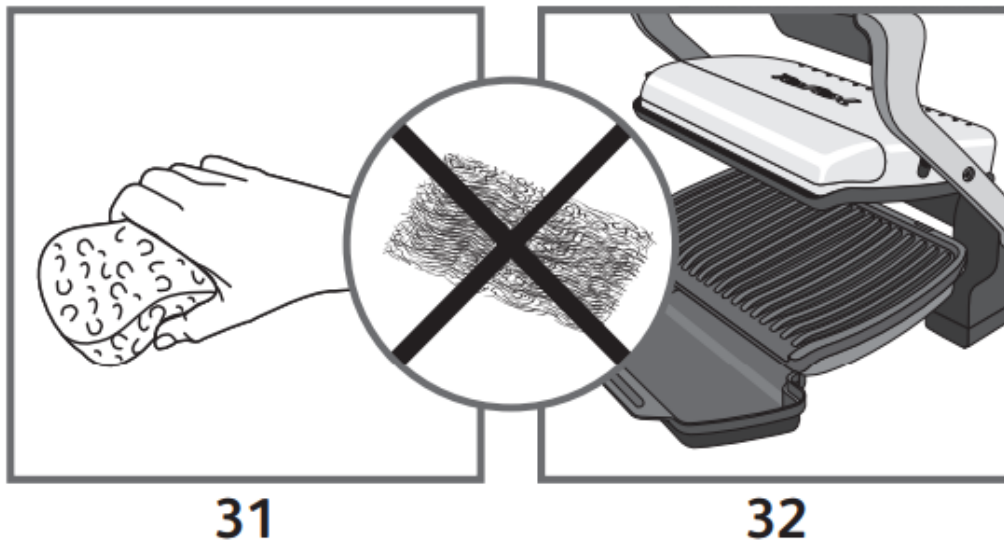

Empty the juice collection tray and wash in warm water and a little washing-up liquid, then dry it carefully with a paper towel or dry soft cloth.

33 To clean the outside of the grill, wipe with a warm, wet sponge and dry with a soft, dry cloth.

34 Do not immerse the body of the grill in water or any other liquid.

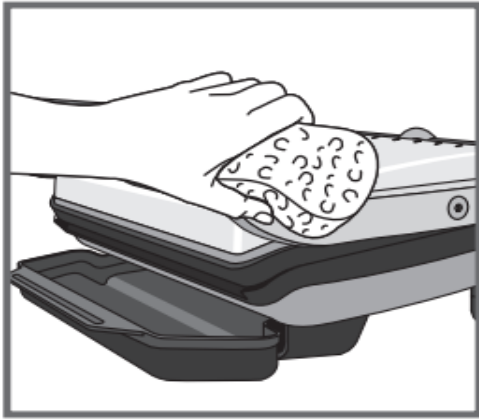

33

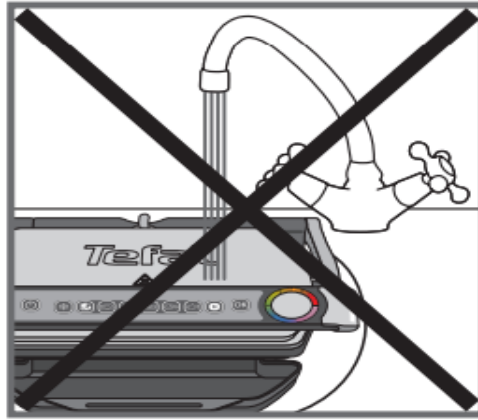

34

35 Always make sure the grill is clean and dry before storing.

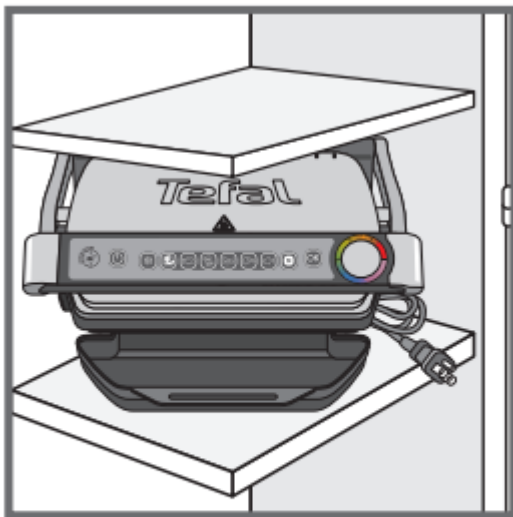





35



36 Any repairs must be carried out by an approved service representative.

Trouble shooting guide

Problem	Cause	Solution
The appliance switches to manual mode when starting a cooking cycle.	<ul style="list-style-type: none"> Starting a cooking cycle without preheating. 	2 possible options: - allow to cook, but you must monitor the cooking (white LED = manual mode) - stop the







		appliance, remove the food, close the appliance properly, reprogram the appliance and wait until end of preheating.
The appliance switches to manual mode when starting a cooking cycle.	<ul style="list-style-type: none"> • Appliance failure. 	Contact your local Tefal Customer Service.
The appliance stops during the pre-heating or cooking cycle.	<ul style="list-style-type: none"> • The appliance has been kept open for too long while preheating or cooking. • The appliance has been idle too long after the end of warm up or keep warm. 	Disconnect the appliance from the mains leave for 2-3 mins, restart the process. The next time you use the appliance, make sure you open and close it briefly for best cooking results. If the problem continues, contact your local Tefal Customer Service.
Indicator  flashing after placing the food on the cooking plates.	<ul style="list-style-type: none"> • Not sensing the food. Meat thickness too thin. • Appliance failure. 	You must confirm the start of the cooking by pressing the  button.
 Flashing white indicator light. + button  flashing or button  flashing	<ul style="list-style-type: none"> • Appliance stored or used in a room that is too cold. 	Disconnect and reconnect your appliance and immediately restart a preheat cycle. If the problem persists, contact your Customer Service.
The appliance no longer beeps.		
I have put in my food and closed the appliance but cooking has not started.	<ul style="list-style-type: none"> • Your food has a depth thicker than 4 cm. • Your food is under 4 mm thick. 	Food must not be thicker than 4cm. You must confirm the start of the cooking by pressing the button OK. Wait for the audible beep and the cooking level indicator to flash purple before adding food.



Tip, especially for meat: the cooking results on the preset programmes may vary depending

	<ul style="list-style-type: none"> You have not waited for the appliance to pre-heat. 	
<p>I have put in my food but the indicator stays on PURPLE</p> 	<ul style="list-style-type: none"> You have not completely opened the grill when putting on the food. 	Completely open the grill then close it.
	<ul style="list-style-type: none"> Not sensing the food. Meat thickness too thin. Minimum thickness = 4mm 	Confirm the start of the cooking by pressing the button  .
The appliance turns itself off during cooking in manual mode.	<ul style="list-style-type: none"> The cooking time has exceeded 30 minutes. 	Press the on/off button and re-start the manual mode.

on origin, cut and quality of the food being cooked, the programmes have been set and tested for good quality food. Similarly, the thickness of the meat has to be taken into account during cooking; you may not cook food that is thicker than 4 cm.

Program table

Dedicated program	Cooking level colour indicator		
			
 Red meat	Rare	Medium	Well-done
 Burger	Rare	Medium	Well-done
 Panini	Lightly cooked	Well-done	Crispy

























 Fish	Lightly cooked	Medium	Well-done
 Chicken*			Fully cooked
 Sausage*			Fully cooked

* Chicken and sausages must only be cooked well-done.



Tips: if you like your meat blue rare, you can use

Cooking table for out of program food

Food		Cooking program	Cooking level
			 rare  medium  well-done
Bread	slices of bread, toasted sandwiches		
	burger: (after pre-cooking the meat)		
Meat & Poultry	Pork fillet (boneless), pork belly		
	Lamb (boneless)		
	Frozen chicken nuggets 		
	Gammon steak		
	Marinated chicken breast		
Vegetables	Potatoes (3 mm slices) Leeks (7-8 mm slices) Courgettes (7-8 mm slices) Peppers		
Fish	Whole trout		
	Shelled prawns		
	King prawns (with and without shells on)		
	Tuna steak		
Manual mode	Toasted sandwiches, panini... (thin slices of similar thickness)		Fixed temp

For frozen food, press  before selecting your program.

Warning

This content is compiled from multiple sources and is provided for reference purposes only. It may not be complete or fully applicable to all situations. If you are unable to resolve your issue, please contact the product manufacturer or an authorized service provider for official support.

Document generated by [ManualsFile](#)

