

## How to assemble your vacuum cleaner

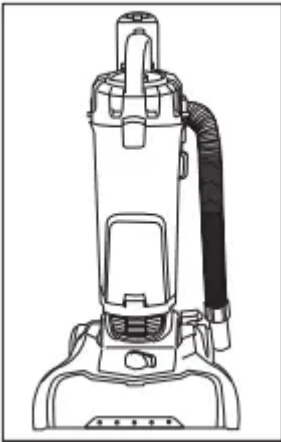

Vacuum cleaner with dust cup

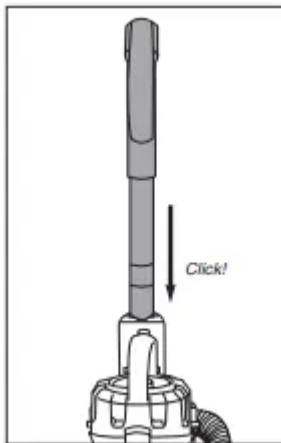

Slide handle into top of vacuum cleaner. Push down until it clicks.

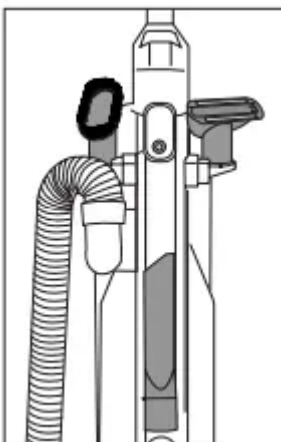

Store accessories on back of vacuum cleaner.

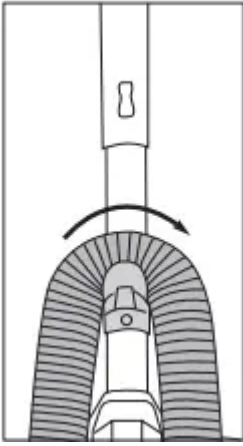

Loop hose over hose retainer.

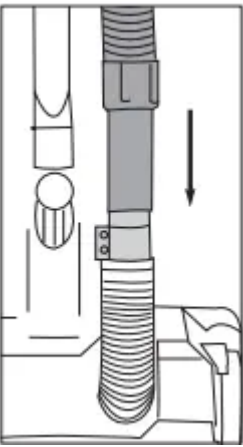

Push loose end of hose securely onto hose inlet.

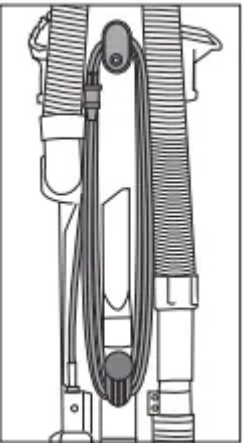

Wrap cord onto upper and lower cord wrap.



Select models only  
(NEU182-NEU188  
except NEU182A)



Store turbo brush on front of handle. Align brush opening with slot and push to snap tool into clip.

# How to identify parts of your vacuum cleaner

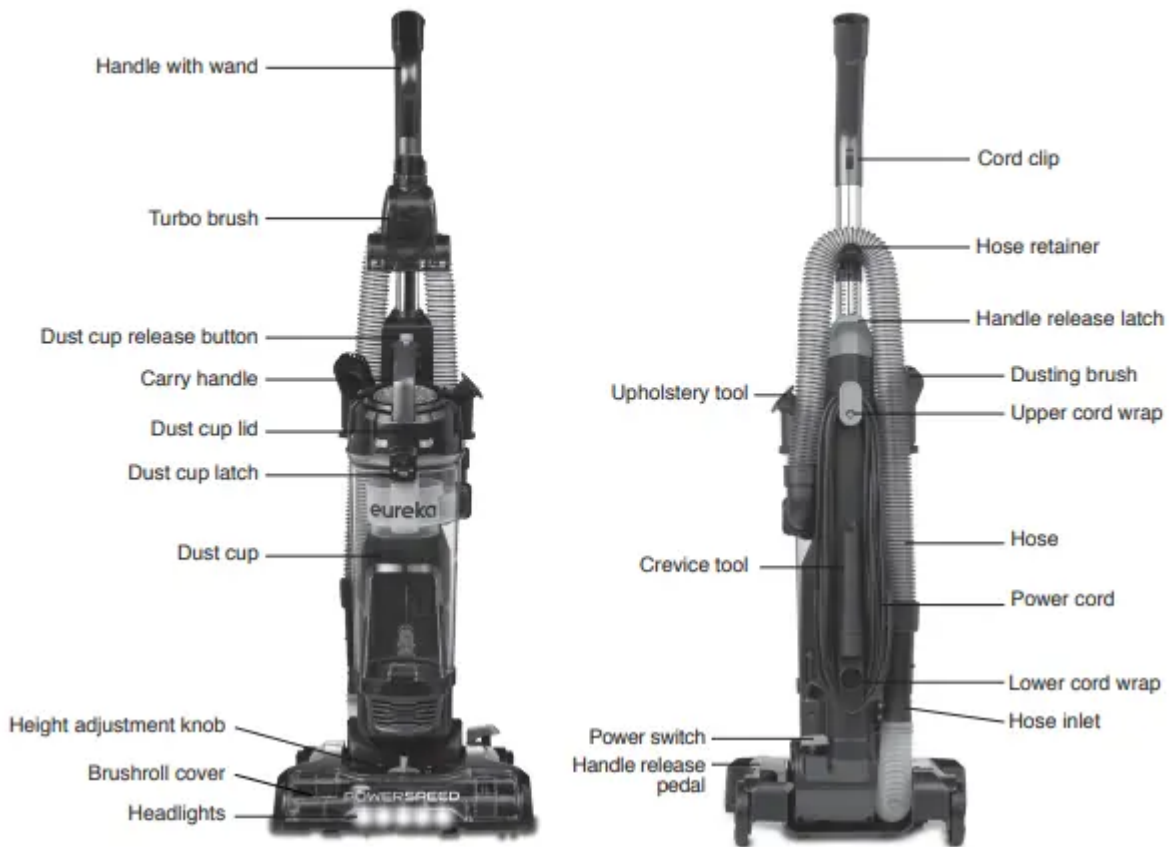

**Headlights are included on select models only (NEU186-NEU188). Accessories may vary depending on which model was purchased.**

## For filter maintenance instructions, see page 9

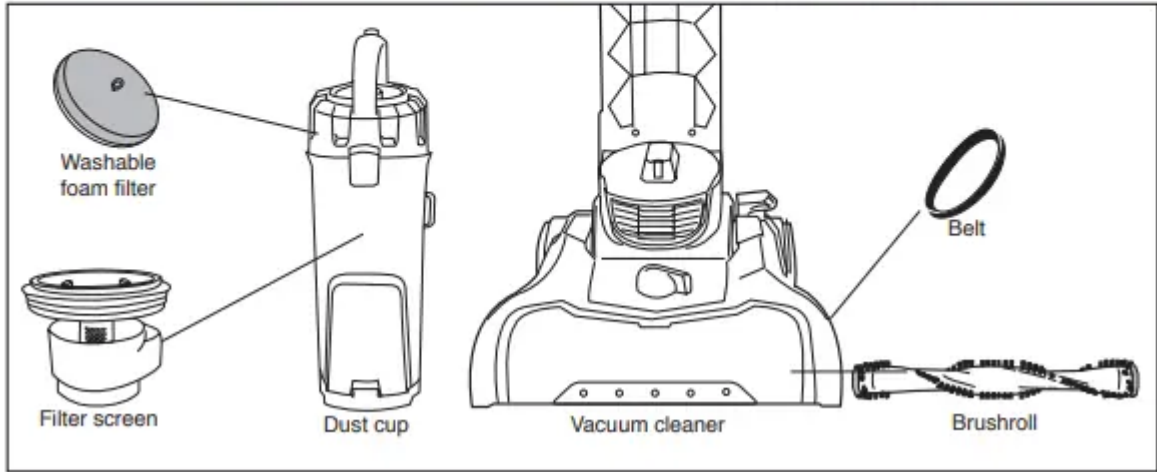

## How to use your vacuum cleaner

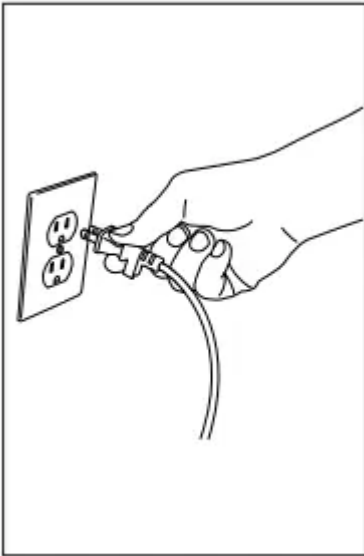

Plug power cord into outlet

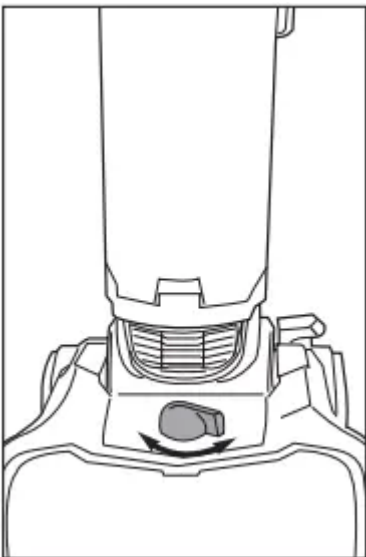

Turn height adjustment knob to adjust from bare floors to high pile carpet

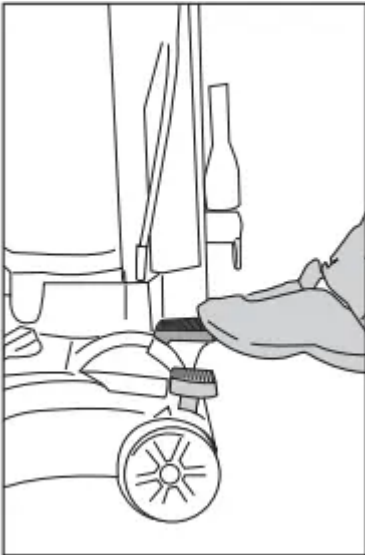

Step on power switch to turn vacuum cleaner on. Step on again to turn off.

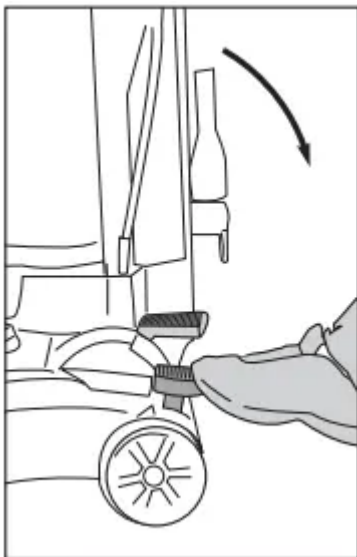

Step on handle release to lower handle into position for vacuuming floors.

**Empty dust cup after every use**

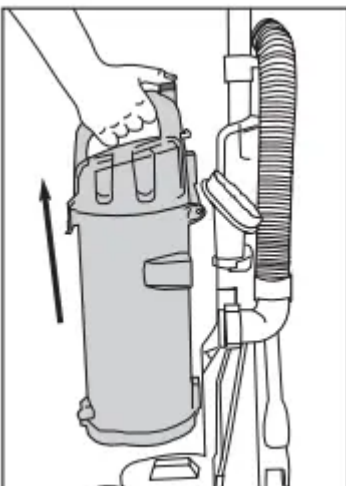

Press release button and lift off dust cup



To empty debris, press lever to release bottom lid.

## How to use accessories

- Place vacuum in upright position.
- Turn height adjustment knob to highest position.
- Pull up on hose connection to release hose end from hose inlet (Fig. 1).
- Push end of hose into top of handle and twist clockwise until it clicks (Fig. 2).
- Press handle release latch and pull out handle with wand (Fig. 3).
- To attach accessories, push desired tool onto end of wand (Fig. 4).
- To use accessories without handle and wand, push desired tool directly onto end of hose (Fig. 5).
- When finished using accessories, twist hose counterclockwise and pull off handle. Slide handle into top of vacuum cleaner and push down until it clicks. Push loose end of hose securely onto hose inlet. Store tools on vacuum cleaner back.

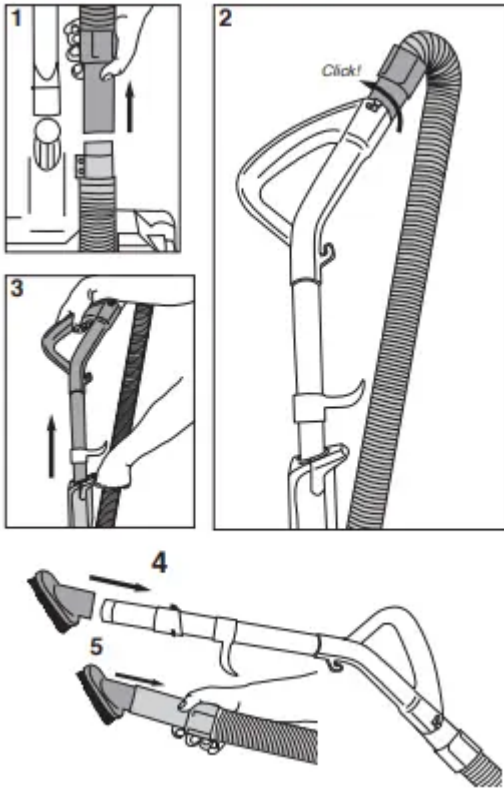

## How to maintain dust cup and filters

Dust cup – Empty after each use

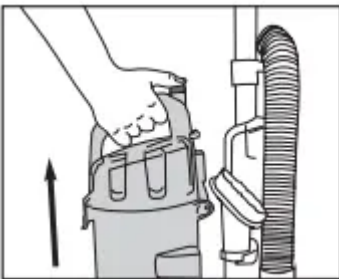

Press release button and lift off dust cup



Hold dust cup over wastebasket and press lever to release bottom lid. Debris will empty.

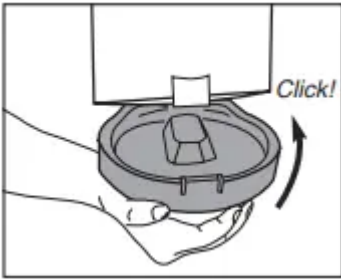

Close bottom lid until it clicks.

**Washable dust cup filters – Clean monthly**



Pull dust cup latch to lift up dust cup lid.

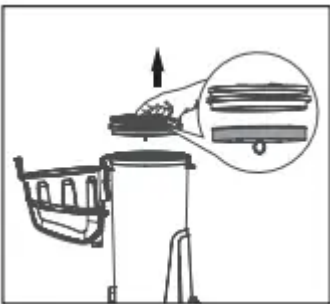

Lift out foam filter and shake off dust. Rinse foam filter and dry THOROUGHLY

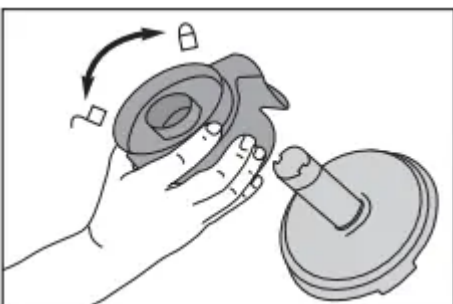

Grip tabs and lift out filter screen. Twist bottom of filter screen counterclockwise to unlock and pull apart. Shake off dust. Rinse screen and dust cup. Dry all THOROUGHLY. Reassemble screen; twist clockwise to lock.



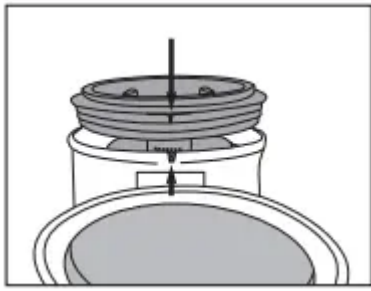

Align tab on filter screen with slot on back of dust cup and drop into position.

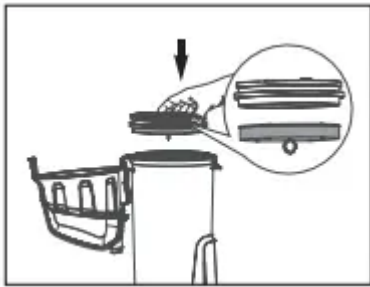

Reinstall foam filter.

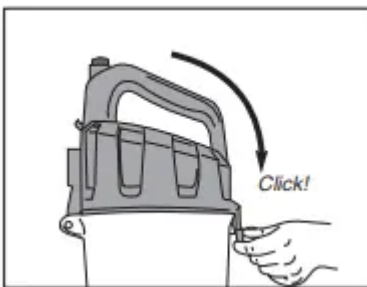

Close cover until it clicks.

## How to clear a blockage

If vacuum is not cleaning floors, or if no suction at end of hose, check to be sure air path is not blocked.

- Press release button and lift off dust cup (Fig. 1).
- Empty debris. Hold over wastebasket and press lever to release bottom lid (Fig. 2).
- Check filter and filter screen.
- Remove any debris and shake off dust. (See maintenance instructions.)
- Loosen end of hose.
- Use a rod or similar blunt implement to clear a blockage in wand or hose. Flex hose to loosen debris (Fig. 3). Use caution if there is any risk that glass or nails could have become imbedded in hose.
- Use finger to check for debris in air path (Fig. 4).

- Reinstall filter and filter screen inside dust cup and position dust cup onto vacuum cleaner.

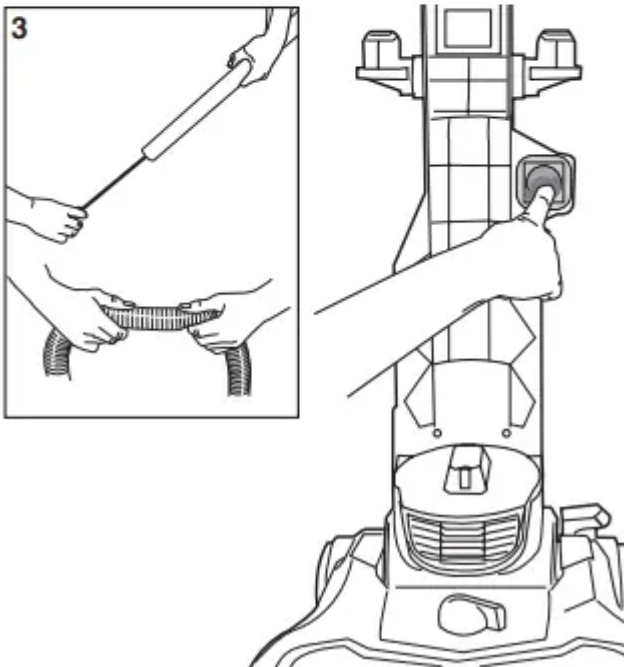
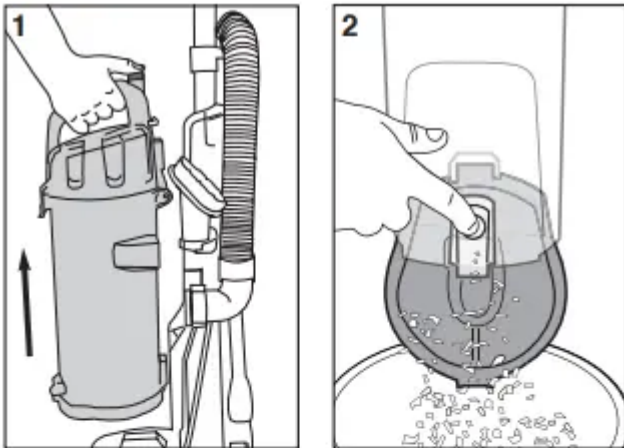

## How to maintain brushroll

- Step on handle release to lower handle.
- Turn vacuum face down on floor.
- To avoid unnecessary service calls, check brushroll for debris.
- Use scissors to clip heavy threads or strings.

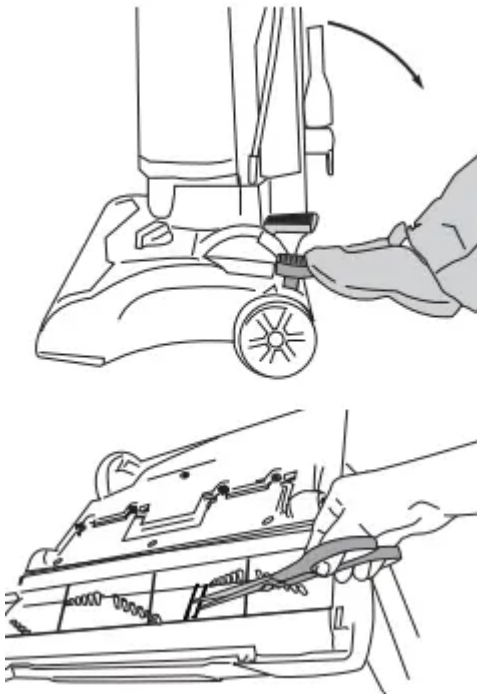

## How to maintain turbo brush

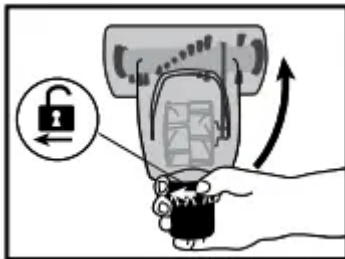

Grasp collar and twist to unlock cover. Lift cover up

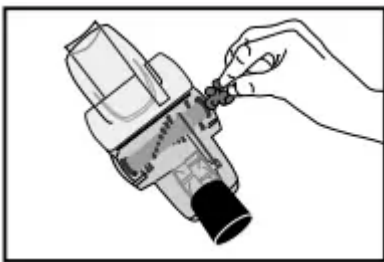

With cover open, use fingers or small brush to clear accumulated pet hair from bristles.

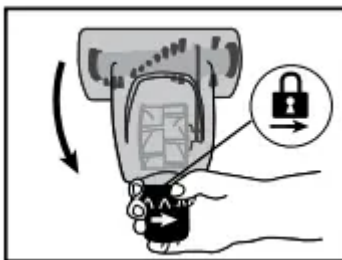

Close cover and twist collar to lock.

## How to replace brushroll or belt

- Step on handle release and lay vacuum cleaner face down.
- Use Phillips screwdriver to remove 6 screws from brushroll cover (Fig. 1). Lift off cover. Refer to Fig. 7 for location of screws.
- Rotate right end of brushroll and lift out (Fig. 2).
- Lift out left end of brushroll.
- To replace belt, position new belt around motor shaft (Fig. 3).
- Loop new belt around brushroll shaft at left end of brushroll (Fig. 4).
- To reposition brushroll into base, pull belt down and insert left end of brushroll first. Align brushroll end cap with slot so it fits into position (Fig. 5). Press right end of brushroll into position.
- To replace brushroll cover, align slot on cover with tab (Fig. 6) and snap cover into place. Replace 6 screws (Fig. 7).

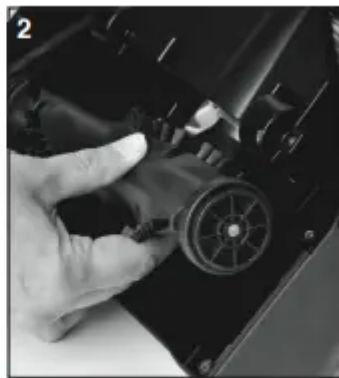

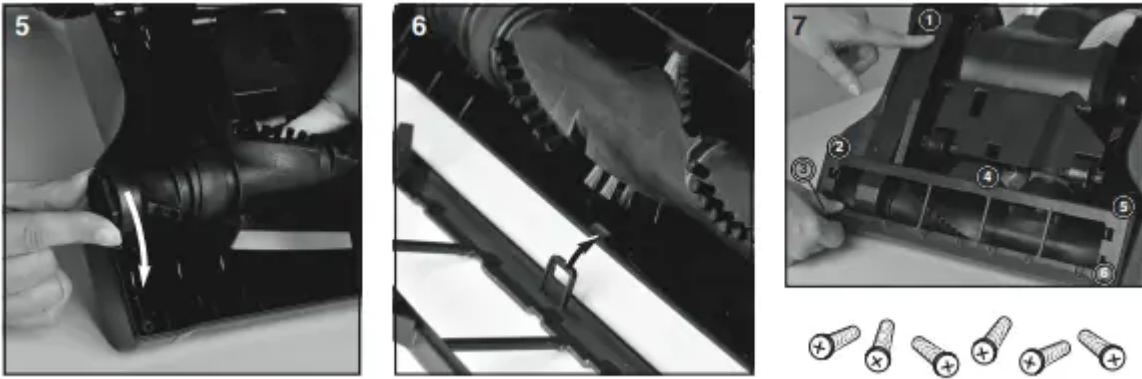

## Problem solving

### NOTICE: Thermal cut-off

This vacuum cleaner has a special thermostat that protects the vacuum in case of motor overheating.

If the vacuum suddenly shuts off, proceed as follows:

- 1) Push the power switch to off and unplug the vacuum.
- 2) Check the vacuum for a possible source of overheating such as a full dust cup, blocked hose or clogged filter. If these conditions are found, fix them and wait at least 30 minutes before attempting to use the vacuum.
- 3) After the 30 minute period, plug the vacuum back in and turn on the switch. If the vacuum still does not work, call the Eureka Customer Service HELPLINE at 1-800-282-2886.

### Motor will not start.

- Push plug securely into outlet, try another outlet or check circuit breaker.
- Step on power switch to turn vacuum on.
- See detailed “thermal cut-off” instructions above.

### Vacuum cleaner does not clean floors.

- Empty dust cup, clean and/or change filter.
- Clean or replace filter regularly to maintain suction.
- Check vacuum height adjustment knob position.
- Clean brushroll if needed.

### No suction at the end of hose or wand.

- See other solutions above.
- Remove clogs from the hose or wand that restrict the airflow.

**Burning smell; brushroll will not turn.**

- Check brushroll for debris.
- Replace broken or out of shape belt.

**Vacuum is hard to push.**

- Adjust vacuum height knob to a higher position.
- Check brushroll for debris and clean if needed.

**Turbo brush will not turn (select models: NEU182-NEU188 except NEU182A).**

- Check turbo brush for debris

**Warning**

This content is compiled from multiple sources and is provided for reference purposes only. It may not be complete or fully applicable to all situations. If you are unable to resolve your issue, please contact the product manufacturer or an authorized service provider for official support.