

Installation

Location Requirements

The location selected for the ice machine head section must meet the following criteria. If any of these criteria are not met, select another location.

- The location must be indoors and must be free of airborne and other contaminants.
- The location must not be near heatgenerating equipment or in direct sunlight.
- The location must allow enough clearance for water, drain, and electrical connections in the rear of the ice machine.
- The location must not obstruct airflow through or around the ice machine

Installation Requirements

- The ice machine and bin must be level.
- Vent the ice machine and bin drains separately.
- Bin drain termination must have an air gap.
- The ice machine and bin must be descaled and sanitized after installation.
- The drain line must contain a union or other suitable means of disconnection at the ice machine.

QuietQube Models Only

- The ice machine top panel can be trimmed with an aviator snips to allow the line set, water line and electrical connections to exit the top. Only cut out what is needed, the back panel must support the top panel
- The water inlet and electrical connection must contain a service loop to allow future access.

Minimum/Maximum Temperatures

Model	Minimum Air Temperature	Maximum Air Temperature
All Ice Machine Head Sections	35°F 2°C	110°F 43°C

Remote Condensers	Minimum Air Temperature	Maximum Air Temperature
All Models	-20°F -29°C	120°F 49°C

QuietQube Condensing Units	Minimum Air Temperature	Maximum Air Temperature
CVDF0600 CVDF0900 CVDT1200 CVDF2100	-20°F -29°C	120°F 49°C
CVDF1400 CVDF1800	-20°F -29°C	130°F 54°C



Ice Machine Heat of Rejection

Ice Machine Series	Heat of Rejection	
	Air Conditioning	Peak
IF0300 IT0300	4600	5450
IT0420	3800	6000
IT0450	3800	6000
IT0500	3800	6000
IF0500	3800	6000
IP0500	3800	6000
IP0520	3800	6000
IF0600	11800	13700
IT0620	5400	6300
IT0750	12800	13700
IF0900	13000	16000
IT0900	12700	14800
IT1200	16200	19100
IT1500	23000	27000
IT1900	26100	30500

Use this information when:

- Sizing air conditioning equipment where self-contained air-cooled ice machines are installed.
- Determining the load on a cooling tower. Use the peak figure for sizing the load.

Clearance Requirements

IF0300 IT0300	Self- Contained Air-Cooled	Self- Contained Water-Cooled
Top/Sides	16" (40 cm)	8" (20 cm)
Back	5" (13 cm)	5" (13 cm)

IT0420 IT0620	Self- Contained Air-Cooled	Water-Cooled or Remote Condenser
Top/Sides	12" (31 cm)	8" (20 cm)
Back	5" (13 cm)	5" (13 cm)

IT0450 IT0500 IF0500 IP0500 IP0520 IF0600 IT0750 IF0900 IT0900	Self- Contained Air-Cooled	Self- Contained Water-Cooled
Top/Sides	8" (20 cm)	8" (20 cm)
Back	5" (13 cm)	5" (13 cm)

NOTE: Top air discharge kits require the same clearance requirements as the comparable self-contained air-cooled model.

IT1200 60 Hz	Self- Contained Air-Cooled	Water-Cooled or Remote Condenser
Top/Sides	8" (20 cm)	8" (20 cm)
Back	5" (13 cm)	5" (13 cm)

IT1200 50 Hz	Self- Contained Air-Cooled	Water-Cooled or Remote Condenser
Top	12" (31 cm)	8" (20 cm)
Sides	23" (58 cm)	8" (20 cm)
Back	8" (20 cm)	5" (13 cm)



IT1500	Self-Contained Air-Cooled	Water-Cooled or Remote Condenser
Top	12" (31 cm)	8" (20 cm)
Sides	8" (20 cm)	8" (20 cm)
Back	12" (31 cm)	5" (13 cm)

IT1900	Self-Contained Air-Cooled	Water-Cooled or Remote Condenser
Top/Sides	24" (61 cm)	8" (20 cm)
Back	12" (31 cm)	5" (13 cm)
Bristol Compressor		

¹IT1900	Self-Contained Air-Cooled	Water-Cooled or Remote Condenser
Top/Sides	8" (20 cm)	8" (20 cm)
Back	5" (13 cm)	5" (13 cm)
¹Copeland Compressor		

QuietQube Model Clearance Requirements

Model	Top	Back	Sides
IF0600C IT0750C IF0900C IT0900C IT1200C	5" (13 cm)	5" (13 cm)	5" (13 cm)
IBF0620C IBF0820C IBT1020C IF1400C IF1800C IF2100C	2"*** (5 cm)	5" (13 cm)	8" ** (20 cm)
** 24" (61 cm) is recommended on top/sides for servicing			

Condensing Unit Clearance Requirements



Model	Top/Sides	Back	Front
CVDF0600 CVDF0900 CVDT1200 CVDF1400 CVDF1800 CVDF2100	0"* (0 cm)	48" (122 cm)	48" (122 cm)
* 24" (61 cm) is recommended on top/sides for servicing			

Air Baffle

Self-Contained Air-cooled Only

The air-cooled baffle prevents condenser air from recirculating.

To install:

1. Loosen the back panel screws next to the condenser.
2. Align the keyhole slots in the air baffle with the screw holes and slide the baffle down to lock in place.

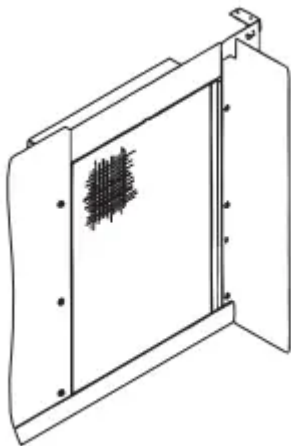

Bin Installation Requirements

- The installation area must be capable of supporting the combined weight of the equipment and product.
- All ice machines installed on a bin require an ice deflector.
- Manitowoc bins have a deflector installed and require no modifications when used with a forward-facing evaporator.
- Ice machines with multiple evaporators require a deflector kit.

- Align sides and back of ice machine with sides and back of bin when placing ice machine on bin.
- Optional sales kits are available to adapt various sized or multiple ice machines on large bins.

Bin Installation

NOTE: When using casters, the units must be tethered or secured to comply with all applicable codes. Swivel casters must be mounted on the front and rigid casters must be mounted on the rear. Lock the front casters after installation is complete

1. Remove threaded plug from drain fitting.
2. Screw the leveling legs onto the bottom of the bin.
3. Screw the foot of each leg in as far as possible.
4. Move the bin into its final position.
5. Level the bin to assure that the bin door closes and seals properly. Use a level on top of the bin. Turn the base of each foot as necessary to level the bin.
6. Inspect bin gasket prior to ice machine installation. (Manitowoc bins come with a closed cell foam gasket installed along the top surface of the bin.)
7. Remove all panels from ice machine before lifting and installing on bin. Remove front panel, top cover, left and right side panels.

Dispenser Installation

Observe following recommendations unless required by the dispenser manufacturer.

- An adapter is not required for ice machines that match the dispenser size.
- A deflector is not required
- Ice level management is recommended to prevent water leakage or movement of ice machine during agitation.
- Align sides and back of ice machine with sides and back of dispenser when placing ice machine.
- Follow ice machine installation procedures in this manual and any additional installation requirements specified by the dispenser manufacturer

Electrical Requirements

All electrical work, including wire routing and grounding, must conform to local, state and national electrical codes. The following precautions must be observed:

- The ice machine must be grounded.

- A separate fuse/circuit breaker (dedicated circuit) must be provided for each ice machine head section, condenser or condensing unit.
- A qualified electrician must determine proper wire size dependent upon location, materials used and length of run (minimum circuit ampacity can be used to help select the wire size)

Voltage

The maximum allowable voltage variation is +10% / -5% of the rated voltage at ice machine start-up (when the electrical load is highest).

Fuse/Circuit Breaker

A separate electrical disconnect, which disconnects all poles and has 3 mm (1/8") contact separation, must be provided for fixed wiring. Circuit breakers must be H.A.C.R. rated in USA

Minimum Circuit Ampacity

The minimum circuit ampacity is used to help select the wire size of the electrical supply. (Minimum circuit ampacity is not the ice machine's running amp load.) The wire size (or gauge) also depends on location, materials used, length of run, etc., so it must be determined by a qualified electrician.

Ground Fault Circuit Interrupter

We do not recommend the use of a GFCI/ GFI circuit protection with our equipment. If a GFCI/GFI is required by code, use a GFCI/GFI breaker rather than an outlet, which is more prone to intermittent nuisance trips than panel circuit breakers.

Maximum Breaker Size & Minimum Circuit Amperage Chart

NOTE: Due to continuous product improvements, this information is for reference only. Please refer to the ice machine data plate to verify electrical data. Model/Serial data plate information overrides information listed on this page.

Ice Machine	Voltage/Phase/Cycle	Air-Cooled		Water-Cooled		Remote Condenser	
		Maximum Fuse/Circuit Breaker	Minimum Circuit Amps	Maximum Fuse/Circuit Breaker	Minimum Circuit Amps	Maximum Fuse/Circuit Breaker	Minimum Circuit Amps
IF0300	115/1/60	15	10.8	15	10.0	---	---
	230/1/50	15	6.1	15	5.6	---	---
	230/1/60	15	6.1	15	5.7	---	---
IT0300	115/1/60	15	8.8	15	7.9	---	---
	230/1/50	15	4.2	15	3.8	---	---
	230/1/60	15	4.2	15	3.8	---	---
IT0420	115/1/60	15	11.3	15	10.6	---	---
	208-230/1/60	15	5.5	15	5.2	---	---
	230/1/50	15	5.7	---	---	---	---
IT0450	115/1/60	20	11.9	20	11.2	---	---
	208-230/1/60	15	5.6	15	5.3	---	---
	230/1/50	15	5.6	15	5.3	---	---
IT0500	115/1/60	15	11.5	15	10.8	20	13.7 14.8
	208-230/1/60	15	5.1	15	4.8	---	---
	230/1/50	15	5.6	---	---	---	---
IF0500	115/1/60	---	---	---	---	20	14.8
	208-230/1/60	---	---	---	---	15	11.7
IP0500	115/1/60	15	11.5	---	---	---	---
	208-230/1/60	15	5.1	---	---	---	---
	230/1/50	15	5.6	---	---	---	---
IP0520	115/1/60	15	11.5	---	---	---	---
	208-230/1/60	15	5.1	---	---	---	---
	230/1/50	15	5.6	---	---	---	---
IF0600	208-230/1/60	15	11.1	15	10.7	15	11.7 8.9
	230/1/50	15	6.7	15	6.1	15	7.1 8.1
IT0620	115/1/60	20	12.2	20	11.6	---	---
	208-230/1/60	15	5.9	15	5.6	---	---
	230/1/50	15	5.6	15	5.4	---	---



Ice Machine	Voltage/Phase/ Cycle	Air-Cooled		Water-Cooled		Remote Condenser	
		Maximum Fuse/Circuit Breaker	Minimum Circuit Amps	Maximum Fuse/Circuit Breaker	Minimum Circuit Amps	Maximum Fuse/Circuit Breaker	Minimum Circuit Amps
IT0750	208-230/1/60	15	8.4 8.3	15	8.1 7.9	---	---
	230/1/50	15	8.4 6.7	15	8.1 6.5	---	---
IF0900	208-230/1/60	20 15	12.2 9.5	20	11.2 8.8	20 15	12.2 9.8
	208-230/3/60	15	9.7	15	8.7	15	9.7 7.2
	230/1/50	15	8.9	15	8.2	15	8.6 9.0
IT0900	208-230/1/60	15	9.5	15	8.8	---	---
	230/1/50	15	10.7	15	10.1	---	---
IT1200	208-230/1/60	20	14.2	20	13.4	15	11.0 10.9
	208-230/3/60	15	8.6	15	7.9	15	9.2 10.1
	230/1/50	20	14.0	20	13.3	15 25	11.1 15.6
IT1500	208-230/1/60	25 30	15.4 18.5	25 30	14.0 17.0	25	14.0 15.6
	208-230/3/60	20	12.8 13.4	20	11.3 12.0	20 25 20	11.3 15.3 13.0
	230/1/50	25 20	14.9 14.3	25 20	14.2 13.5	25 20	15.2 14.6
IT1900	208-230/1/60	30	17.9 20.1	25 25 30	16.5 15.0 18.8	25 30 30	17.0 18.5 19.3
	208-230/3/60	20	14.2 14.4	20	12.8 13.0	20	13.0 13.1
	230/1/50	25	15.8 16.5	25	15.0	25	15.3 15.8
	380-460/3/50-60	---	---	15	6.1	---	---

¹Alternate compressor - Refer to model serial tag on ice machine to verify your minimum circuit amps.

QuietQube Head Sections

Ice Machine	Voltage/Phase/ Cycle	Maximum Fuse/ Circuit Breaker	Minimum Circuit Amps	Total Amps
Ice Beverage Models	115/1/60	15 amp	---	1.2
	230/1/50	15 amp	---	1.0
All Non IB QuietQube Models	115/1/60	15 amp	1.2	---
	230/1/50	15 amp	1.0	---

CVD Condensing Units



Condensing Unit	Voltage/Phase/Cycle	Maximum Fuse/Circuit Breaker	Minimum Circuit Amps	Minimum Wire Size Required by Manitowoc
CVDF0600	208-230/1/60	15 amp	11.6 9.0	#12 Solid Copper Conductor
	208-230/3/60	15 amp	10.2 6.6	#12 Solid Copper Conductor
	230/1/50	15 amp	10.2	#12 Solid Copper Conductor
CVDF0900	208-230/1/60	20 amp	11.5	#10 Solid Copper Conductor
	208-230/3/60	15 amp	7.1	#12 Solid Copper Conductor
	230/1/50	20 amp	8.7	#10 Solid Copper Conductor
CVDT1200	208-230/1/60	25 amp 20 amp	14.8 13.3	#10 Solid Copper Conductor
	208-230/3/60	15 amp	9.3 11.1	#12 Solid Copper Conductor
CVDF1400	208-230/1/60	20 amp	14.2 11.1	#10 Solid Copper Conductor
	208-230/3/60	15 amp	11.1	#12 Solid Copper Conductor
CVDF1800	208-230/1/60	30 amp	19.2	#8 Solid Copper Conductor
	208-230/3/60	20 amp	13.3	#10 Solid Copper Conductor
	230/1/50	40 amp	25.0	#8 Solid Copper Conductor
CVDF2100	208-230/1/60	50 amp	40.0	#6 Solid Copper Conductor
	208-230/3/60	30 amp	30.0	#10 Solid Copper Conductor

¹Alternate compressor - Refer to model serial tag on ice machine to verify your minimum circuit amps.

Water Supply and Drain Line Sizing/Connections

Location	Water Temperature	Water Pressure	Ice Machine Fitting	Tubing Size up to Ice Machine Fitting
Ice Making Water Inlet	40°F (4.4°C) Min. 90°F (32°C) Max.	20 psi (140 kPa) Min. 80 psi (550 kPa) Max.	3/8" Female Pipe Thread	3/8" (10 mm) minimum inside diameter
Ice Making Water Drain	—	—	1/2" Female Pipe Thread	1/2" (13 mm) minimum inside diameter
Condenser Water Inlet	40°F (4.4°C) Min. 90°F (32°C) Max.	20 psi (140 kPa) Min. 276 psi (1900 kPa) Max.	I0300 - I1000 = 3/8" Female Pipe Thread I1200 - I1800 = 1/2" Female Pipe Thread	
Condenser Water Drain	—	—	1/2" Female Pipe Thread	1/2" (13 mm) minimum inside diameter
Bin Drain	—	—	3/4" Female Pipe Thread	3/4" (19 mm) minimum inside diameter
Large Capacity Bin Drain	—	—	1" Female Pipe Thread	1" (25 mm) minimum inside diameter

Min. = Minimum, Max. = Maximum



Water Connections

- Local water conditions may require treatment of the water to inhibit scale formation, filter sediment, and remove chlorine odor and taste.
- Connect ice making water inlet to potable water only.
- Install a water shut-off valve for potable water and water cooled condenser lines.
- Do not connect the ice machine to a hot water supply. Verify hot water restrictors installed on other equipment are functioning correctly. (Check valves on sink, faucets, dishwashers, etc.)
- Install a water regulating valve if water pressure exceeds the maximum valve rating.
- Insulate water and drain lines to prevent condensation.

Water Supply and Drain Connections

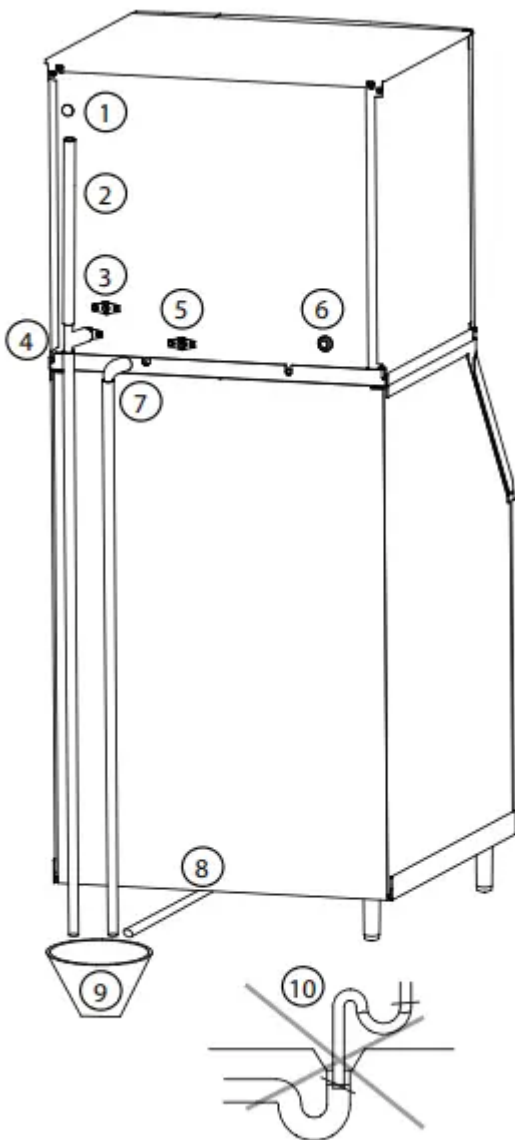

Item	Description
1	Electrical Entrance
2	Vent Tube - Minimum Height 18" (46 cm)
3	Potable Water Inlet - 3/8" FPT
4	Potable Water Drain - 1/2" FPT
5	Condenser Water Outlet - 1/2" FPT Water-cooled Models Only Install Separate Drain When Used
6	Condenser Water Inlet See "Condenser Water Inlet" on page 22 for fitting sizes
7	Base Drain - 1/2" CPVC Socket
8	Bin Drain - See "Bin Drain" on page 22 for fitting sizes
9	Floor Drain - Open and Trapped
10	Do Not Trap Drain Line - Leave Air Gap Between Drain Line and Floor Drain

AIR GAP

A greater than 1-inch air gap is built into the ice machine for back-flow prevention. This air gap exceeds NSF 12 requirements for back-flow prevention.

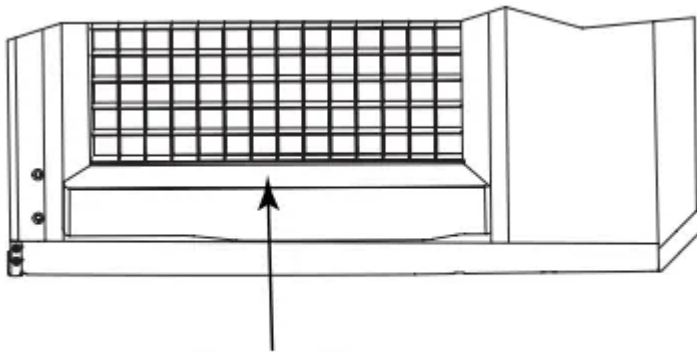

This air gap is greater than 1"

Cooling Tower Applications (Water-Cooled Models)

A water cooling tower installation does not require modification of the ice machine.

- Water pressure at the condenser cannot exceed 276 psig (1900 kPa).
- Water entering the condenser must not exceed 90°F (32°C).
- Water flow through the condenser must not exceed 5 gallons (19 liters) per minute.

- Allow for a pressure drop of 7 psi (50 kPa) between the condenser water inlet and the outlet of the ice machine.
- Water exiting the condenser must not exceed 110°F (43°C)

Drain Connections

Follow these guidelines when installing drain lines to prevent drain water from flowing back into the ice machine and storage bin:

- Drain lines must have a 1.5 inch drop per 5 foot (2.5 cm per meter) of run and must not create traps.
- The floor drain must be large enough to accommodate drainage from all drains.
- Run separate bin and ice machine drain lines. Insulate them to prevent condensation.
- Install a tee at the ice machine drain outlet and install an 18" (46 cm) vent above the drain line.
- Drain termination must have an air gap that meets local code.

Auxiliary Base Drain Installation

An auxiliary drain is located in the ice machine base to remove moisture in high humidity areas.

1. View the back of the ice machine base on the compressor side and locate and remove the cap plug.
2. Route tubing to an open site drain:

Use 1/2 inch CPVC tubing.

- Apply a bead of silicone around the exterior of the ice machine tubing and insert into ice machine base. The silicone will secure the tubing and provide a watertight seal.
- Provide support for tubing.

Remote Condenser and Condensing Unit Refrigeration System Installation

Each ice machine head section ships from the factory with a refrigerant charge appropriate for the entire system operation. The serial tag on the ice machine indicates the refrigerant charge.

QuietQube® Ice Machine	Remote Condenser	Line Set*	Additional Refrigerant Charge for 50' to 100' (15 to 30 Meter) Line Sets
IF0600C IBF0620C	CVDF0600	RC-21 RC-31 RC-51	1.5 lbs - 680 g
IBF0820C IF0900C	CVDF0900		2 lbs - 907 g
IBT1020C	CVDT1200		2 lbs - 907 g
IT1200C			2 lbs - 907 g
IF1400C	CVDF1400	RC-20 RC-30 RC-50	2 lbs - 907 g
IF1800C	CVDF1800		2 lbs - 907 g
IF2100C	CVDF2100	RC-23 RC-33 RC-53	4 lbs - 1814 g

*Line Set	Suction Line	Liquid Line	Minimum Insulation Thickness
RC 21/31/51	5/8 inch 16 mm	3/8 inch 10 mm	1/2" (13 mm) Suction Line 1/4" (7 mm) Liquid Line
RC 20/30/50	3/4 inch 19 mm	1/2 inch 13 mm	1/2" (13 mm) Suction Line 1/4" (7 mm) Liquid Line
RC 23/33/53	3/4 inch 19 mm	5/8 inch 16 mm	1/2" (13 mm) Suction Line 1/4" (7 mm) Liquid Line

Remote Condenser Models



Ice Machine	Remote Condenser	Additional Amount of Refrigerant to Be Added to Nameplate Charge for 50' to 100' (15 to 30 Meter) Line Sets
IF0500N	JCF0500	1.5 lbs - 680 g
IT0500N	JCT0500	1.5 lbs - 680 g
IF0600N	JCF0900	1.5 lbs - 680 g
IF0900N	JCF0900	2 lbs - 907 g
IT1200N	JCT1200	2 lbs - 907 g
IT1500N	JCT1500	2 lbs - 907 g
IT1900N	JCT1500	2 lbs - 907 g

Line Set	Discharge Line	Liquid Line	Model
RT 20/35/50 R404A	1/2 inch (13 mm)	5/16 inch (7.9 mm)	IF0500N IF0600N IF0900N
RT 20/35/50 R410A	1/2 inch (13 mm)	5/16 inch (7.9 mm)	IT0500N IT1200N
RL 20/35/50 R410A	1/2 inch (13 mm)	3/8 inch (9.5 mm)	IT1500N IT1900N

NOTE: R404A line sets have white protective caps and R410A line sets have pink protective caps.

CALCULATING INSTALLATION DISTANCES

Line Set Length

The maximum tubing length is 100 feet (30 meters).

Line Set Rise/Drop

The maximum rise is 35 feet (10.7 meters).

The maximum drop is 15 feet (4.5 meters).

Calculated Line Set Distance

The maximum calculated distance is 150 feet (45 meters). Line set rises, drops, horizontal runs (or combinations of these) in excess of the stated maximums will exceed compressor start-up and design limits. This will cause poor oil return to the compressor. Make the following calculations to make sure the line set layout is within specifications.

1. Insert the measured rise into the formula below. Multiply by 1.7 to get the calculated rise.
2. Insert the measured drop into the formula below. Multiply by 6.6 to get the calculated drop.
3. Insert the measured horizontal distance into the formula below. No calculation is necessary
4. Add together the calculated rise, calculated drop, and horizontal distance to get the total calculated distance. If this total exceeds 150 feet (45 meters), move the condenser/ condensing unit to a new location and perform the calculations again.

Maximum Line Set Distance Formula

Step 1. Measured Rise (R) 35 feet (10.7 meters)

Maximum _____ x 1.7 = _____ Calculated Rise

Step 2. Measured Drop (D) 15 feet (4.5 meters)

Maximum _____ x 6.6 = _____ Calculated Drop

Step 3. Measured Horizontal Distance (H) 100 feet (30 meters)

Maximum _____ Horizontal Distance

Step 4. Total Calculated Distance 150 feet (45 meters)

Maximum _____ Total Calculated Distance

REMOTE CONDENSER MODELS

Step 1 Secure the Condenser.

Through-holes are provided to secure the condenser to a curb, rack or wooden timber

Step 2 Route the Refrigeration Tubing.

Route the refrigeration tubing between the ice machine head section and the condenser.

- Maximum line set exposed on rooftop is 25% of total line set length.
- A qualified person must perform all roof penetrations.
- Interconnecting wire must be routed between the ice machine and condenser.

Step 3 Connect the Line Set.

In most cases, by routing the line set properly, shortening will not be necessary.

When shortening or lengthening is required, do so before connecting the line set to the ice machine or the remote condenser. This prevents the loss of refrigerant in the ice machine or condenser. The quick connect fittings on the line sets are equipped with access valves. Use these valves to recover any vapor charge from the line set

When lengthening or shortening lines, follow good refrigeration practices, purge with nitrogen and insulate all tubing. Do not change the tube sizes. Evacuate the lines and place about 5 oz (145 grams) of vapor refrigerant charge in each line.

1. Remove the dust caps from the line set, condenser and ice machine.
2. Apply refrigeration oil to the threads on the quick-disconnect couplers before connecting them to the condenser.
3. Carefully thread the female fitting to the condenser or ice machine by hand, then tighten the couplings with a wrench until they bottom out.
4. Turn an additional quarter turn to ensure proper brass-to-brass seating. Torque to the following specifications:

Liquid Line	Discharge Line
10 - 12 ft lbs 13.5-16.2 N•m	35 - 45 ft lbs 47.5-61.0 N•m

5. Check all fittings and valve caps for leaks and reinstall and tighten caps.
6. Interconnecting line voltage wiring is used to energize and de-energize the condenser fan motor. The remote condenser voltage matches the ice machine head section voltage.

Interconnecting Wiring Connections	
Ice Machine	Remote Condenser
F1	L1
F2	L2

Installation is finished for remote condenser models. Proceed to page 32 for start-up procedure.

QUIETQUBE MODELS

Step 1 Secure the Condensing Unit.

Through-holes are provided to secure the condensing unit to a curb, rack or wooden timber.

Step 2 Route the Refrigeration Tubing.

Route the refrigeration tubing between the ice machine head section and the condenser or CVD condensing unit.

- A suction line oil trap is required when rise is more than 20 feet (6 meters).
- Only one trap is allowed in the line set.
- Shorten the line set as required, do not coil line set.

Manitowoc S-Trap Kit

Model	S-Trap Kit Number	Tubing Size
IBF0620C IBF0820C IBT1020C IF0600C IF0900C IT1200C	K00172	5/8 inch (16 mm)
IF1400C IF1800C IF2100C	K00166	3/4 inch (19 mm)

- Maximum amount of time the refrigeration system can be exposed to the atmosphere is 15 minutes.
- Purge line set with dry nitrogen while brazing
- Shutoff valves for the line set on the ice machine must remain closed and be protected from heat during brazing.
- The condensing unit ships with a 50/50 mixture of nitrogen/helium.

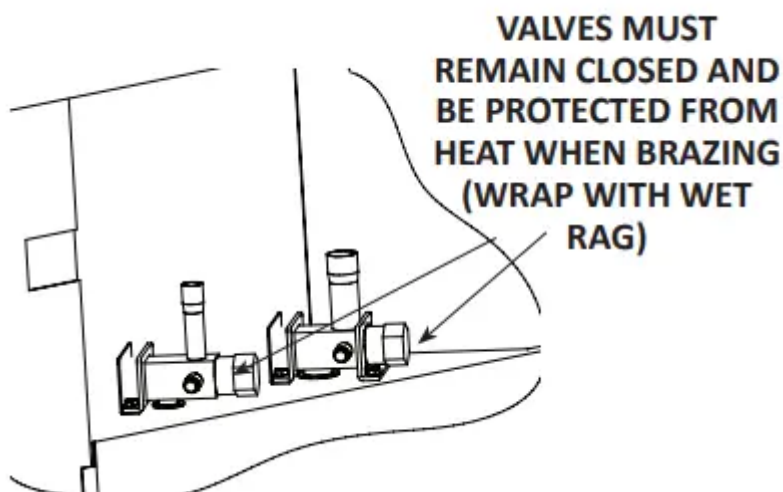

Step 3 Pressure Test and Evacuate Line Set and CVD Condensing Unit

- Shutoff valves for the line set must remain closed until pressure testing and evacuation are complete.
- Valve core removal tools that allow for removal and installation of the valve cores without removing hoses for the manifold gauge set are recommended to decrease the evacuation time.
- Pressure test at 150 psi (1000 kPa) for a minimum of 15 minutes.
- Minimum evacuation level is 500 microns.

Pressure test the line sets and CVD Condensing Unit with 150 psi (1000 kPa) of dry nitrogen. Add nitrogen at the shutoff valves for the line set located at the back of the ice machine head section or from the access valves located in the CVD Condensing Unit. Complete the pressure test, verify no

leaks are present and remove the nitrogen from the system before connecting the vacuum pump. Connect vacuum pump and evacuate system to 500 microns.

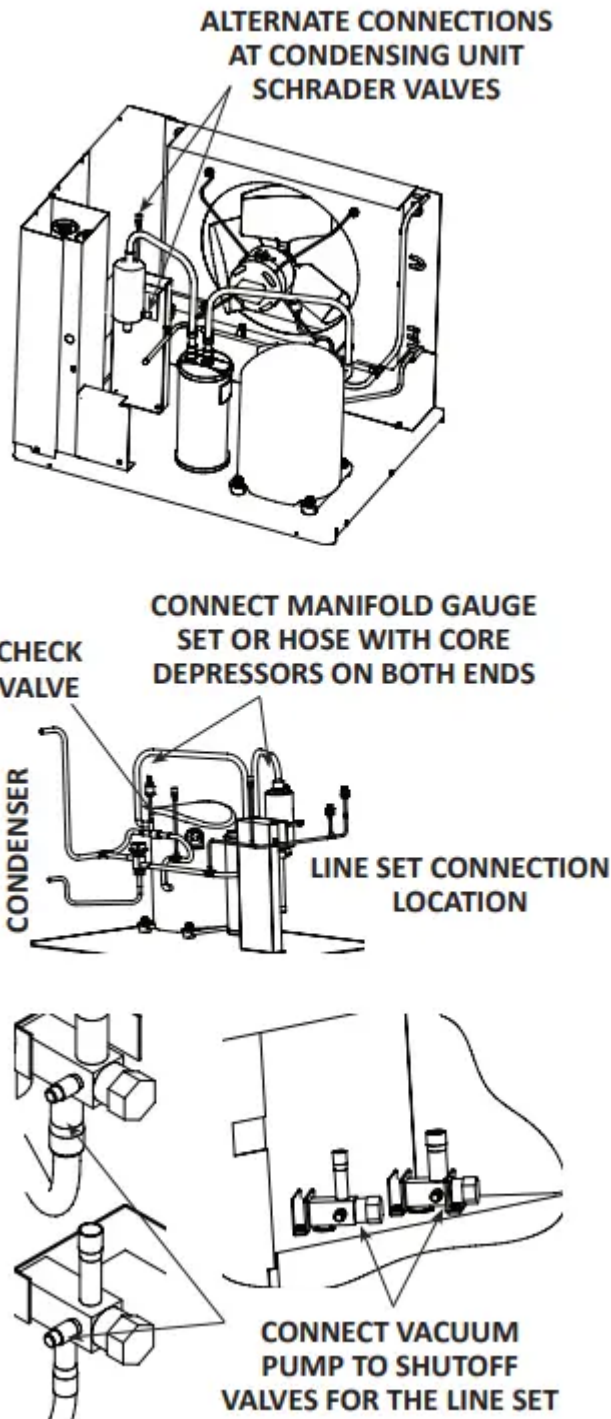

Step 4 Open Valves for the Line Set and Receiver

You will not hear refrigerant flow when the valves are opened. Refrigerant will not flow until the ice machine is started and the solenoid valve opens

- All valve caps must be reinstalled, tightened and leak-checked to assure no refrigerant leakage exists.

- Counterclockwise opens all valves. Open the shutoff valves for the suction and liquid lines

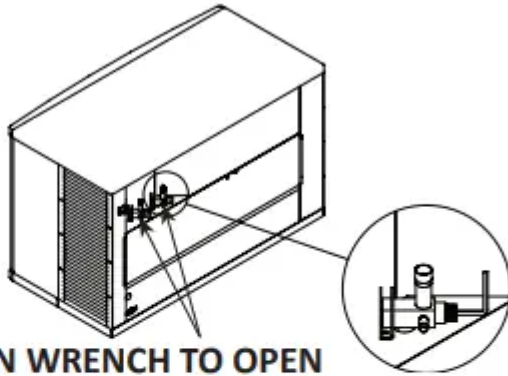

**USE ALLEN WRENCH TO OPEN
(TURN COUNTERCLOCKWISE)
SHUTOFF VALVES FOR THE LIQUID
AND SUCTION LINES**

QuietQube Models



**USE ALLEN WRENCH
TO OPEN (TURN
COUNTERCLOCKWISE)
SHUTOFF VALVES
FOR THE LIQUID AND
SUCTION LINES**

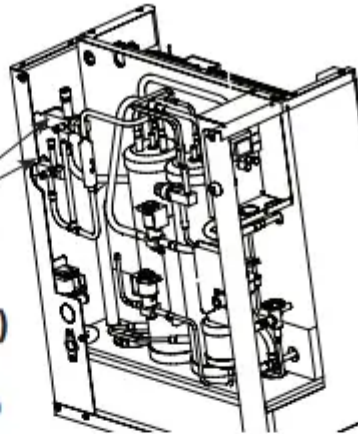

Ice Beverage Models

**USE ALLEN WRENCH TO OPEN
(TURN COUNTERCLOCKWISE)
SHUTOFF VALVES FOR THE
LIQUID AND SUCTION LINES**

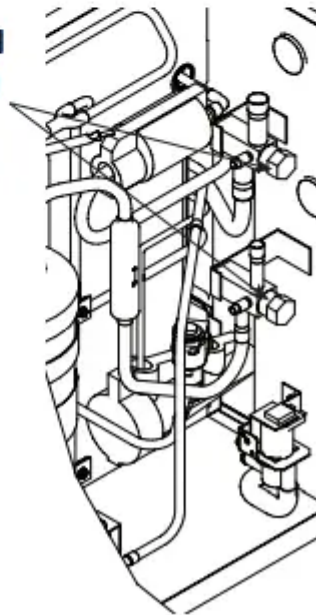

Step 5 Leak-Check the Refrigeration System.

- A. Connect power to the ice machine head section - Do not connect power to the CVD condensing unit.
- B. Press the power switch and energize the ice machine for 60 seconds to equalize pressures.
- C. Disconnect power to the ice machine head section.
- D. Leak-check line set connections, S trap and all factory joints in head section and condensing unit.
- E. Connect power to the CVD condensing unit and allow system to pump down.

Step 6 Insulation Requirements.

- To prevent condensation, the entire suction line, including the shutoff valve, must be insulated.
- All insulation must be airtight and sealed at both ends.

The following insulation requirements prevent condensation at 90° F (32°C) ambient temperature and 90% relative humidity. If higher humidity is expected, increase insulation thickness:

Suction Line	Liquid Line	Min. Insulation Thickness
3/4 inch (19 mm)	1/2 inch (13 mm)	Suction Line - 1/2" (13 mm) Liquid Line - 1/4" (7 mm)
5/8 inch (16 mm)	3/8 inch (10 mm)	
3/4 inch (19 mm)	5/8 inch (16 mm)	Suction Line - 3/4" (19 mm) Liquid Line - 1/4" (7 mm)

Step 7 Insulation for the Suction Shutoff Valve.

The insulation for the suction shutoff valve is located in the plastic bag taped to the water curtain.

Step 8 Ice Beverage Models Only.

The thermostat probe must be moved from the shipping position to the ice-making position.

- The bin thermostat probe must be rotated down to enable ice contact and proper operation
- Verify probe wire does not interfere with the water curtain.
- The control is preset and does not require programming.

1. Loosen thumbscrew securing probe.
2. Rotate the probe from horizontal to vertical position.
3. Tighten thumbscrew to secure probe.

Starting the Ice Machine

Starting the ice machine and completing the Operational Checks are the responsibilities of the owner/operator. Adjustments and maintenance procedures outlined in this manual are not covered by the warranty.

REMOVE ICE THICKNESS PROBE SHIPPING BRACKETS

Remove and discard shipping brackets before starting the ice machine





Step 1 Ice machine must be programmed refer to “Setup Wizard” on page 37 for details.

Step 2 Refer to “Descaling and Sanitizing” on page 43 and clean and sanitize the ice machine and bin before placing in operation.

Step 3 Refer to “Ice Making Sequence of Operation” on page 39 for operational details.

MINIMUM/MAXIMUM SLAB WEIGHT

Adjust ice thickness to maintain the correct bridge thickness and “Minimum/Maximum Slab Weight” on page 41.

Operation



Touch Screen Features

The Indigo® NXT control panel offers a series of pressure-sensitive buttons and an interactive touchscreen.

Buttons

Power Button: Provides On/Off functions for the ice machine.

Lock/Unlock Button: Allows or prevents touchscreen navigation.







Cleaning Button: Initiates a cleaning cycle. Refer to Section 4 for details.

Touchscreen

Home screen allows viewing of ice machine status, alerts and messages. Navigation with the touchscreen provides access to menu items, machine information, settings and event logs. Setup and Energy Saver settings can be adjusted along with access to service and troubleshooting information.

Icons: Provide status indication and allow navigation by pressing the icon.

HOME SCREEN ICON DESCRIPTIONS

Icon	Description
<p>Home Screen</p> 	<p>Center portion of the screen displays the current condition of the ice machine - Making ice, bin full, program mode or machine off</p>
<p>Alert</p> 	<p>Alert icon with number of messages. Pressing this icon will display the alert log which will allow viewing and resetting of alerts</p>
<p>Message</p> 	<p>Notification icon with quantity of messages. Pressing this icon will display the routine maintenance reminder screen which will allow viewing and resetting of the reminder</p>
<p>Menu</p> 	<p>Menu icon will take you to the main menu</p>
<p>Information</p> 	<p>Information icon provides model and serial number, installation date and other information specific to the ice machine</p>
<p>Service Locator</p> 	<p>Provides contact information for your local service support - Default is the Manitowoc Ice website service locator</p>
<p>Lock/Unlock</p> 	<p>Indicates if screen is locked or unlocked</p>
	<p>Only visible when a LuminIce® II accessory is connected.</p> <p>Blue S - Normal operation</p>

LuminIce



Red S - Replace bulb

Red/Blue alternating - Incorrect bulb installed

Performance Specifications

NOTE: The performance statistics are calculated based on the performance of the machine at 90 degree ambient temperature and 70 degree water temperature. The actual statistics may vary depending on your operating conditions.

Setup Wizard























Screens will automatically advance after a selection is made or press the right arrow to advance one screen, press left arrow to go back one screen. All settings can be accessed and changed without the wizard by using menu screen navigation.

Setup	Description
Press ON/ OFF Button	On/Off button is used to start/stop ice making.
Enter Model Number	Only visible if model number can not be automatically identified. The ice machine will not start without model identification.
Select Language	Default is English. Scroll to select a different language
Start Wizard	Setup wizard will guide ice machine programming
Accessory Detection	Detects if Ice Level Sensor, LuminIce II or AuCS are connected. Checkmark = yes - X = no
USB Setup	Only used when setup features have been transferred to a USB drive. Skip screen by selecting right arrow.
Configure Date and Time Formats	Select Month/Day/Year or Day/Month/Year. Select 12 hour or 24 hour time format
Set Time	Use arrows to set local time.
Set Date	Use arrows to set date for your location.
Units	Select standard or metric
Brightness	Configure screen brightness during normal operation.
Ice Program	Program ice machine run times or press right arrow to skip this setup.
Cleaning Reminder	Set descale or sanitize reminder or press right arrow to skip
IAuCS Only when detected	Set frequency of operation when this accessory is installed.
Air Filter Air-cooled models only	Set to ON for self-contained air cooled models.
Water Usage	Factory default or Use less water for reverse osmosis systems or Use more water to improve clarity for unfiltered water
Water Filter	Select Yes or No
LuminIce II Only when detected	12 month reminder is automatically set.

Ice Level Sensor Only when detected	Reminder to rotate the sensor from shipping to operational position.
Wizard Complete	Press right arrow or home icon to return to home screen.

Menu Screen Navigation

Select SETTINGS Icon from the Home Screen to access Main Menu screen.

Energy 	Service 	Settings 	Reset Defaults 
Ice Program 	Data 	Language 	Require Setup Wizard
Water Usage 	Alert Log 	Reminders 	Backup Current Settings
Statistics 	Manual Harvest 	Time & Date 	Reset To Factory Defaults
	Control Board Replacement 	Units 	
	Diagnostics 	Brightness 	
	Contact Information 	USB 	
	USB 	*AuCS 	
	*AuCS 		
	*Prime AuCS Pump 		

* Only visible when this optional accessory is installed

Ice Making Sequence of Operation

The power button must be depressed and the water curtain/ice dampers must be in place on the evaporator before the ice machine will start.

Water Purge Cycle



The ice machine purges any remaining water from the water trough down the drain. Prechill Cycle
The refrigeration system cools the evaporator before the water pump is energized.

Freeze Cycle

Water flows across the evaporator and the refrigeration system chills the evaporator. Ice builds on the evaporator and the freeze cycle continues until the ice thickness probe senses a sheet of ice has formed. The ice thickness probe signals the control board to start a harvest.

Harvest Cycle

Any remaining water is purged down the drain as refrigerant gas warms the evaporator. When the evaporator warms, the sheet of cubes slides off the evaporator and into the storage bin. If all cubes fall clear of the water curtain (or ice damper) the ice machine starts another freeze cycle.

Off Cycle

If the water curtain or ice damper are held open by ice cubes the ice machine shuts off. When the water curtain or ice damper closes, the ice machine starts a new cycle at the water purge.

Control Board Timers

The control board has the following nonadjustable timers:

- The ice machine control board will set its own install date after 100 freeze and harvest cycles.
- The ice machine is locked into the freeze cycle for 6 minutes before a harvest cycle can be initiated.
- The maximum freeze time is 35 minutes at which time the control board automatically initiates a harvest sequence.
- The maximum harvest time is 7 minutes, the control board will perform a water thaw cycle and then return the ice machine to the freeze cycle.

Service Faults

Service Faults are stored and indicated by the control board after three cycles. The number of cycles required to stop the ice machine varies for each Service Fault.

- Long Freeze Cycle - If the freeze time reaches 35 minutes, the control board automatically initiates a harvest cycle. If 6 consecutive 35 minute freeze cycles occur, the ice machine stops.
- Long Harvest Cycle - If the harvest time reaches 7 minutes, the control board automatically returns the ice machine to the freeze cycle. After 3 consecutive long harvest cycles the ice machine stops. Refer to Section 5 if you receive an alert for Service Fault E01 or E02.

Safe Operation Mode

Allows the ice machine to operate up to 72 hours if the ice thickness probe and/or water level probe sensors fail.

- When the control board starts the safe mode, an alert is flashed on the display to notify the end-user they have a production problem.
- The control board automatically initiates and monitors the safe mode. The control will automatically exit the safe mode if a normal signal is received from the input.
- After 72 hours, the control board will enter a standby mode and turn off.

Water Assist Harvest

When the damper/curtain does not open within 3.5 minutes in the harvest cycle the following occurs:

- 3.5 minutes - The water inlet valve energizes until water touches the high water level probe.
- 4 minutes - The water pump energizes.
- 6.5 to 7 minutes - The water dump valve energizes

Water Thaw Cycle

When the damper/curtain does not open during the 7 minute harvest cycle the following water thaw cycle occurs:

- 7 minutes - The compressor, harvest solenoid valve and dump valve deenergize.
1. The water pump remains energized and the water inlet valve energizes until water touches the high water level probe.
 2. Water is circulated over the evaporator.
 3. Water is circulated, dumped and refilled to the high water level probe for approximately 1 hour.
 - At the end of the thaw cycle the ice machine will start another freeze cycle (approximately 1 - 1.75 hour).

Minimum/Maximum Slab Weight

Adjust ice thickness to meet chart specifications.

Model	Minimum Ice Weight Per Cycle lbs Grams	Maximum Ice Weight Per Cycle lbs Grams
IF0300 IT0300	2.40 lbs 1089 grams	2.80 lbs 1270 grams
IT0420 IT0450 IP0520 IT0620C	3.40 lbs 1542 grams	3.90 lbs 1769 grams
IT0500 IF0500 IP0500	4.60 lbs 2087 grams	5.20 lbs 2359 grams
IF0600 IT0750	4.12 lbs 1869 grams	4.75 lbs 2155 grams
IBF0820C	5.75 lbs 2608 grams	6.50 lbs 2948 grams
IF0900 IT0900	6.20 lbs 2812 grams	7.20 lbs 3266 grams
IT1200 IBT1020C	7.50 lbs 3402 grams	8.20 lbs 3719 grams
IF1400C	12.00 lbs 5443 grams	14.00 lbs 6350 grams
IT1500	13.20 lbs 4649 grams	14.80 lbs 5216 grams
IF1800C	15.5 lbs 7031 grams	16.75 lbs 7598 grams
IT1900	13.20 lbs 5987 grams	14.80 lbs 6713 grams
IF2100C	16.00 lbs 7257 grams	17.25 lbs 7824 grams

Ice Thickness Check

After a harvest cycle, inspect the ice cubes in the ice storage bin. The ice thickness probe is factory-set to maintain the ice bridge thickness at 1/8" (3 mm).

NOTE: Make sure the water curtain is in place when performing this check. It prevents water from splashing out of the water trough.

1. Inspect the bridge connecting the cubes. It must be approximately 1/8" (3 mm) thick.
2. If adjustment is necessary, turn the ice thickness probe adjustment screw clockwise to increase bridge thickness, counterclockwise to decrease bridge thickness. Set a 7 mm (9/32") gap between ice thickness probe and evaporator as starting point, then adjust to achieve a 1/8" (3 mm) bridge thickness.



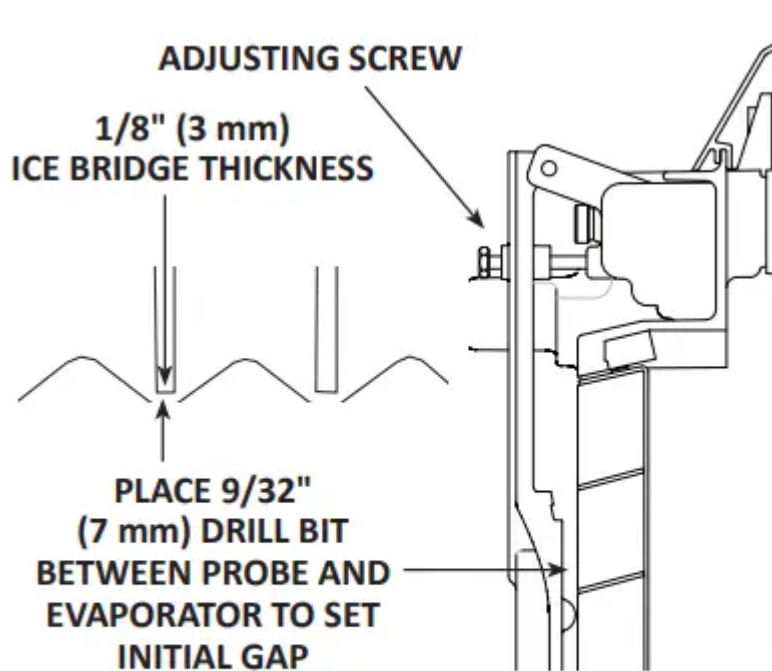

Verify the ice thickness probe wire doesn't restrict probe movement.

Reverse Osmosis or Deionized Water Usage

When using water with low total dissolved solid content (low TDS) the water level probe sensitivity can be increased by moving the jumper over one pin

The Electronic Control Board diagram shows the default position of the jumper covering the left and center pins. Moving the jumper to the center and right pins and enabling R.O. menu "Use less water with reverse osmosis" (Settings/Energy/ Water Usage/Use Less Water With Reverse Osmosis) will increase the sensitivity of the water level probe.

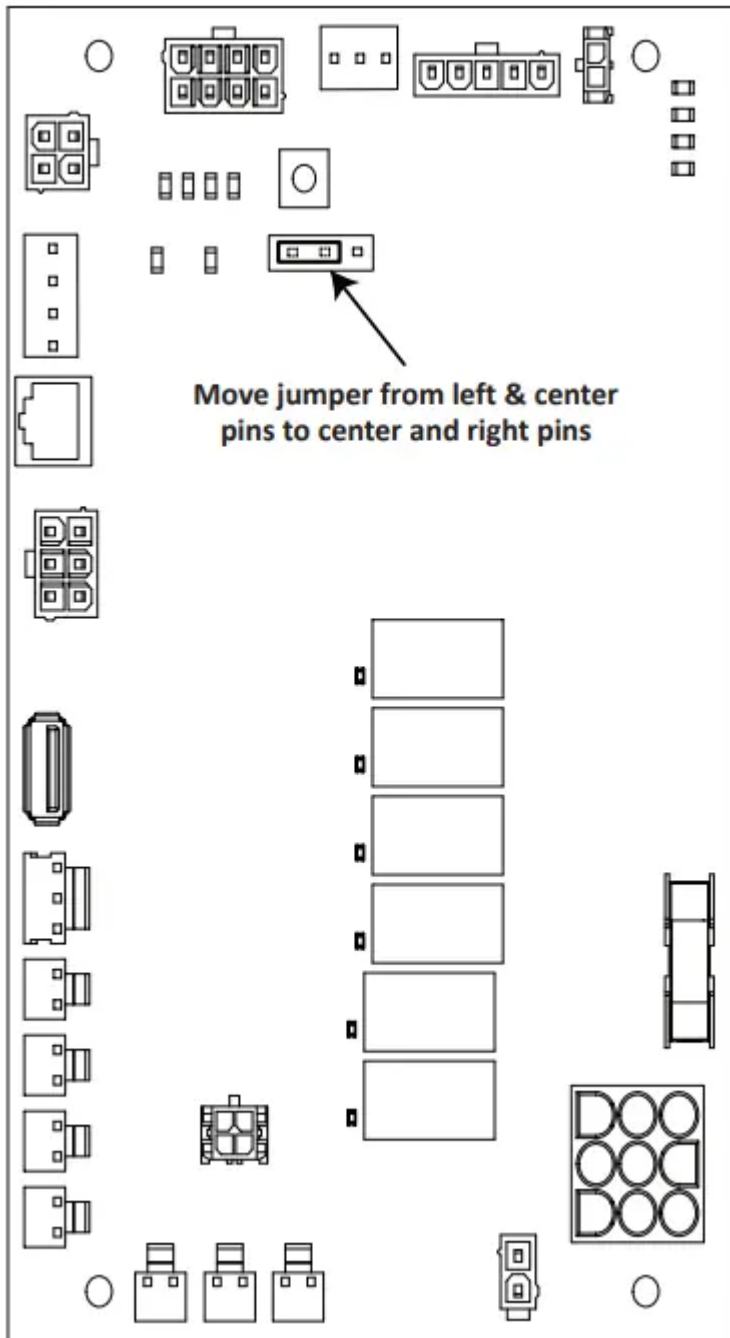

Maintenance

Descaling and Sanitizing

General

You are responsible for maintaining the ice machine in accordance with the instructions in this manual. Maintenance procedures are not covered by the warranty.

Descale and sanitize the ice machine every six months for efficient operation. If the ice machine requires more frequent descaling and sanitizing, consult a qualified service company to test the

water quality and recommend appropriate water treatment. An extremely dirty ice machine must be taken apart for descaling and sanitizing.

Manitowoc Ice Machine Cleaner/Descaler and Sanitizer are the only products approved for use in Manitowoc ice machines.

Ice Machine Inspection

Check all water fittings and lines for leaks. Also, make sure the refrigeration tubing is not rubbing or vibrating against other tubing, panels, etc.

Do not put anything (boxes, etc.) in front of the ice machine. There must be adequate airflow through and around the ice machine to maximize ice production and ensure long component life.

Exterior Cleaning

Clean the area around the ice machine as often as necessary to maintain cleanliness and efficient operation.

Wipe surfaces with a damp cloth rinsed in water to remove dust and dirt from the outside of the ice machine. If a greasy residue persists, use a damp cloth rinsed in a mild dish soap and water solution. Wipe dry with a clean, soft cloth.

The exterior panels have a clear coating that is stain resistant and easy to clean. Products containing abrasives will damage the coating and scratch the panels.

- Never use steel wool or abrasive pads for cleaning.
- Never use chlorinated, citrus based or abrasive cleaners on exterior panels and plastic trim pieces.

Remedial Cleaning Procedure

- This procedure descales all components in the water flow path, and is used between the bi-yearly detailed descaling and sanitizing procedure

Detailed Descaling/Sanitizing Procedure

This procedure must be performed a minimum of once every six months.

- The ice machine and bin must be disassembled descaled and sanitized.
- All ice produced during the descaling and sanitizing procedures must be discarded.

Detailed Descaling and Sanitizing Procedure

Ice machine cleaner/descaler is used to remove lime scale and mineral deposits. Ice machine sanitizer disinfects and removes algae and slime.

Step 1 Open the front door to access the evaporator compartment. Ice must not be on the evaporator during the descaling/ sanitize cycle. Follow one of the methods below:

- Press the power switch at the end of a harvest cycle after ice falls from the evaporator(s).
- Press the power switch and allow the ice to melt.

Step 2 Remove all ice from the bin/ dispenser.

Step 3 Press the Clean button and select “Turn off when complete”. Water will flow through the water dump valve and down the drain. Wait approximately 1 minute until the water trough refills and the display indicates Add Chemical. Add the proper amount of ice machine cleaner/descaler to the water trough by pouring between the water curtain and evaporator, then confirm the chemical was added.

Model	Amount of Cleaner/ Descaler
IF0300/IT0300/IT0420/ IP0520/IT0620	3 oz (90 ml)
IT0450/IT0500/IF0500 IP0500/IF0600/IT0750 IF0900/IT0900/IT1200	5 oz (150 ml)
IBF0620C/IBF0820C IBT1020C	5 oz (150 ml)
IF1400C/IT1500/IT1700 IF1800C/IT1900/IF2100C	9 oz (265 ml)

Step 4 Wait until the cycle is complete (approximately 24 minutes). Then disconnect power to the ice machine (and dispenser when used).

Step 5 Remove parts for descaling.

Step 6 Mix a solution of cleaner/descaler and lukewarm water. Depending upon the amount of mineral buildup, a larger quantity of solution may be required. Use the ratio in the table below to mix enough solution to thoroughly descale all parts.

Solution Type	Water	Mixed With
Cleaner/ Descaler	1 gal (4 L)	16 oz (475 ml) cleaner/descaler



Step 7 Use half of the cleaner/descaler & water mixture to descale all components. Use caution not to expose electrical connectors to liquid and soak parts for 5 minutes (15 - 20 minutes for heavily scaled parts). The solution will foam when it contacts lime scale and mineral deposits; once the foaming stops, use a soft-bristle nylon brush, sponge or cloth (NOT a wire brush) to carefully descale the parts. When descaling is complete rinse all removed components with clean water

Step 8 While components are soaking, use half of the solution to descale all food zone surfaces of the ice machine and bin (or dispenser). Use a nylon brush or cloth to thoroughly descale the following ice machine areas:

- Side walls
- Base (area above water trough)
- Evaporator plastic parts - including top, bottom and sides
- Bin or dispenser

Rinse all areas thoroughly with clean water.

SANITIZING PROCEDURE

Step 9 Mix a solution of sanitizer and lukewarm water.

Solution Type	Water	Mixed With
Sanitizer	3 gal (12 L)	2 oz (60 ml) sanitizer

Step 10 Use half of the sanitizer/ water solution to sanitize all removed components. Fill a spray bottle and use caution not to expose electrical connectors to liquid and liberally apply the solution to all surfaces of the removed parts or soak the removed parts in the sanitizer/water solution. Do not rinse parts after sanitizing

Step 11 Use half of the sanitizer/water solution to sanitize all food zone surfaces of the ice machine and bin (or dispenser). Use a spray bottle to liberally apply the solution. When sanitizing, pay particular attention to the following areas:

- Side walls
- Base (area above water trough)
- Evaporator plastic parts - including top, bottom and sides
- Bin or dispenser

Do not rinse the sanitized areas.

Step 12 Replace all removed components back into their original configuration and wait 20 minutes.



Step 13 Press the Clean button and select “Make ice when complete”. Water will flow through the water dump valve and down the drain. Wait approximately 1 minute until the water trough refills and the display indicates Add

Chemical. Add the proper amount of ice machine sanitizer to the water trough by pouring between the water curtain and evaporator, then confirm the chemical was added.

Model	Amount of Sanitizer
IF0300/IT0300/IT0420/IT0450 IT0500/IF0500/IP0500/IP0520 IF0600/IT0620/IBF0620C IT0750/IBF0820C/IF0900 IT0900/IT1200	3 oz (90 ml)
IBT1020C	3.5 oz (104 ml)
IT1500/IT1900	6 oz (180 ml)
IF1400C/IF1800C/IF2100C	12 oz (355 ml)

Parts Removal for Detailed Descaling and Sanitizing

Single evaporator is shown; Each evaporator will have a distribution tube and water curtain/damper.

A. Remove the water curtain(s)

- Gently flex the curtain in the center and remove it from the right side.
- Slide the left pin out.

B. Remove the ice thickness probe

- Compress the hinge pin on the top of the ice thickness probe.
- Pivot the ice thickness probe to disengage one pin then the other. The ice thickness probe can be descaled and sanitized at this point without complete removal. If complete removal is desired, disconnect the ice thickness control wiring from the control board.

C. Remove the water trough

- Depress tabs on right and left side of the water trough.
- Allow front of water trough to drop as you pull forward to disengage the rear pins.

D. Remove the water level probe

- Pull the water level probe straight down to disengage.
- Lower the water level probe until the wiring connector is visible.
- Disconnect the wire lead from the water level probe.
- Remove the water level probe from the ice machine.

E. Remove the water distribution tube(s)

NOTE: Thumbscrews for the distribution tube are retained to prevent loss. Loosen thumbscrews, but do not pull thumbscrews out of distribution tube.

- Loosen the two outer screws (do not remove screws completely because they are retained to prevent loss) and pull forward on the distribution tube to release from slip joint.
- Disassemble distribution tube by loosening the two (2) middle thumbscrews and dividing the distribution tube into two pieces.

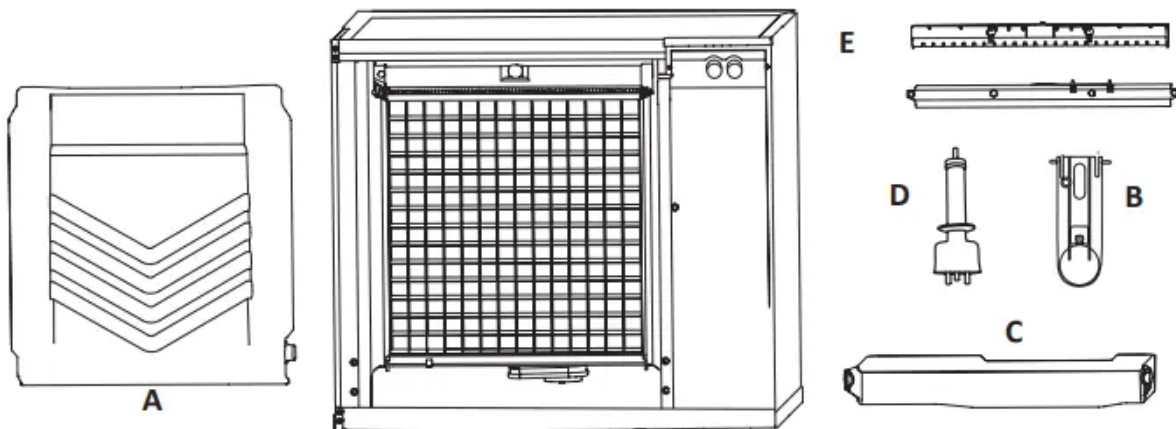

Remedial Cleaning Procedure

This procedure descales all components in the water flow path, and is used to descale the ice machine between the bi-yearly detailed descaling and sanitizing procedure.

Ice machine cleaner/descaler is used to remove lime scale and mineral deposits. Ice machine sanitizer disinfects and removes algae and slime.

Step 1 Ice must not be on the evaporator during the clean/sanitize cycle. Follow one of the methods below:

- Press the power switch at the end of a harvest cycle after ice falls from the evaporator(s).
- Press the power switch and allow the ice to melt

Step 2 Open the front door to access the evaporator.

Step 3 Press the Clean button and select “Make ice when complete”. Water will flow through the water dump valve and down the drain. Wait approximately 1 minute until the water trough refills and the display indicates Add Chemical. Add the proper amount of ice machine descaler to the water trough by pouring between the water curtain and evaporator, then confirm the chemical was added.

Model	Amount of Cleaner/Descaler
IF0300/IT0420 IP0520/IT0620	3 oz (90 ml)
IT0450/IT0500/IF0500 IP0500/IF0600 IT0750/IF0900/IT0900 IT1200	5 oz (150 ml)
IBF0620C/IBF0820C IBT1020C	5 oz (150 ml)
IF1400C/IT1500 IF1800C IT1900/IF2100C	9 oz (265 ml)

Step 4 Close and secure the front door. The ice machine will automatically start ice-making after the clean cycle is complete (approximately 24 minutes).

Cleaning the Air Filter and Condenser

The washable filter on self-contained ice machines is designed to catch dust, dirt, lint and grease. Clean the filter once a month with mild soap and water

A dirty condenser restricts airflow, resulting in excessively high operating temperatures. This reduces ice production and shortens component life.

Clean the condenser at least every six months.

- Shine a flashlight through the condenser to check for dirt between the fins.
- Blow compressed air or rinse with water from the inside out (opposite direction of airflow).
- If dirt still remains, call a service agent to clean the condenser.

Removal from Service/Winterization

All Models

1. Descale and sanitize the ice machine.



2. Turn off the water supply, disconnect and drain the incoming ice-making water line at the rear of the ice machine and drain the water trough.

3. Energize the ice machine, wait one minute for the water inlet valve to open and blow compressed air in both the incoming water and the drain openings in the rear of the ice machine to remove all water

WATER-COOLED MODELS ONLY

- Disconnect the incoming water and drain lines from the water-cooled condenser.
- Insert a large screwdriver between the bottom spring coils of the water regulating valve and pry open the Water Regulating Valve.
- Hold the valve open and blow compressed air through the condenser until no water remains.

All Models

4. Press the power switch and disconnect electrical power at the main disconnect/circuit breaker.

5. Fill spray bottle with sanitizer and spray all interior food zone surfaces. Do not rinse and allow to air dry.

6. Replace all panels.

Troubleshooting

Before Calling for Service Checklist

If a problem arises during operation of your ice machine, follow the checklist below before calling service. Routine adjustments and maintenance procedures are not covered by the warranty.

Problem	Possible Cause	To Correct
Ice machine does not operate.	No electrical power to the ice machine and/or condensing unit.	Replace the fuse/reset the breaker/turn on the main switch.
	High pressure cutout tripping	Clean condenser coil. (See page 49)
	Energy Saver or other field entered programming is stopping ice machine.	Reset to factory defaults.
	Water curtain off or stuck open.	Water curtain must be installed and swinging freely
	Ice machine is not turned on.	Press power button, display must indicate "Making Ice".
	IB Models Only - Dispenser ice level thermostat is open.	Adjust thermostat to maintain correct dispenser level.
Ice machine stops, and can be restarted by pressing the power switch.	Service Fault feature stopping the ice machine.	Refer to "Service Faults" on page 53.
Ice machine does not release ice or is slow to harvest	Ice machine is dirty.	Descale and sanitize the ice machine. (See page 43)
	Ice machine is not level.	Level the ice machine.
	Low air temperature around ice machine head section.	Air temperature must be at least 35° (2°C).
	Fan cycle control does not deenergize condenser fan motor	Call for service.
	Water regulating valve incorrectly adjusted or will not close.	Check for water at condenser drain outlet in harvest cycle. Contact a

		qualified service company to adjust/ replace valve if water is present.
Ice machine does not cycle into harvest mode.	The six-minute freeze time lock-in has not expired yet.	Uneven ice fill (thin at the top of evaporator).
	Ice thickness probe is dirty	Descale and sanitize the ice machine. (See page 43)
	Ice thickness probe is disconnected.	Connect the probe to the control board.
	Ice thickness probe is out of adjustment.	Adjust the ice thickness probe. (See page 41)
	Uneven ice fill (thin at the top of evaporator).	Verify sufficient water level in sump trough. Contact a qualified service company to check refrigeration system.
Ice quality is poor (soft or not clear).	Poor incoming water quality.	Contact a qualified service company to test the quality of the incoming water and make appropriate filter recommendations.
	Water filtration is poor	Replace the filter
	Ice machine is dirty.	Descale and sanitize the ice machine. (See page 43)
	Water dump valve is not working.	Disassemble and clean the water dump valve.
	Water softener is working improperly (if applicable).	Repair the water softener.
Ice machine produces shallow or incomplete cubes, or the ice fill pattern on the evaporator is incomplete.	Ice thickness probe is out of adjustment.	Adjust the ice thickness probe. (See page 41)
	Ice thickness probe is out of adjustment.	Check the water level probe position.

	Water inlet valve filter screen is dirty.	Remove the water inlet valve and clean the filter screen.
	Water filtration is poor.	Replace the filter
	Hot incoming water.	Connect the ice machine to a cold water supply. (See page 22)
	Water inlet valve is not working	Replace the water inlet valve.
	Incorrect incoming water pressure.	Water pressure must be 20 psi - 80 psi (140 kPa - 550 kPa).
	Ice machine is not level	Level the ice machine.
Low ice capacity	Water inlet valve filter screen is dirty	Remove the water inlet valve and clean the filter screen
	Incoming water supply is shut off.	Open the water service valve.
	Water inlet valve stuck open or leaking.	Press the power button and turn off the ice machine, if water continues to enter water trough, replace the water inlet valve.
	The condenser is dirty	Clean the condenser.
	High air temperature entering condenser.	Refer to minimum/maximum air temperature chart for your model on page 14.
	The harvest assist air compressor is not functioning	Call for service.

Service Faults

In addition to the standard safety controls, such as the high pressure cutout, your Manitowoc ice machine features builtin service faults which will stop the ice machine if conditions arise which could cause a major component failure.

Before calling for service, re-start the ice machine using the following procedure:

1. Press the power button. The display reads "Off". Press the power button again, and the display reads "Making Ice".

A. If a service fault has stopped the ice machine, it will restart after a short delay. Proceed to step 2.

B. If the ice machine does not restart, see "Ice machine does not operate" on page 51.

2. Allow the ice machine to run to determine if the condition repeats.

A. If the ice machine stops again, the condition has repeated. Call for service.

B. If the ice machine continues to run, the condition has corrected itself. Allow the ice machine to continue running.

Warning

This content is compiled from multiple sources and is provided for reference purposes only. It may not be complete or fully applicable to all situations. If you are unable to resolve your issue, please contact the product manufacturer or an authorized service provider for official support.

