

## User manual Sound Bar

### ABOUT THIS MANUAL

The user manual has two parts: simple paper USER MANUAL and a detailed FULL MANUAL you can download.



#### USER MANUAL

See this manual for safety instructions, product installation, components, connections, and product specifications.



#### FULL MANUAL

You can access the FULL MANUAL on Samsung's on-line customer support center by scanning the QR code on the left. To see the manual on your PC or mobile device, download the manual in document format from Samsung's website.

## CHECKING THE COMPONENTS

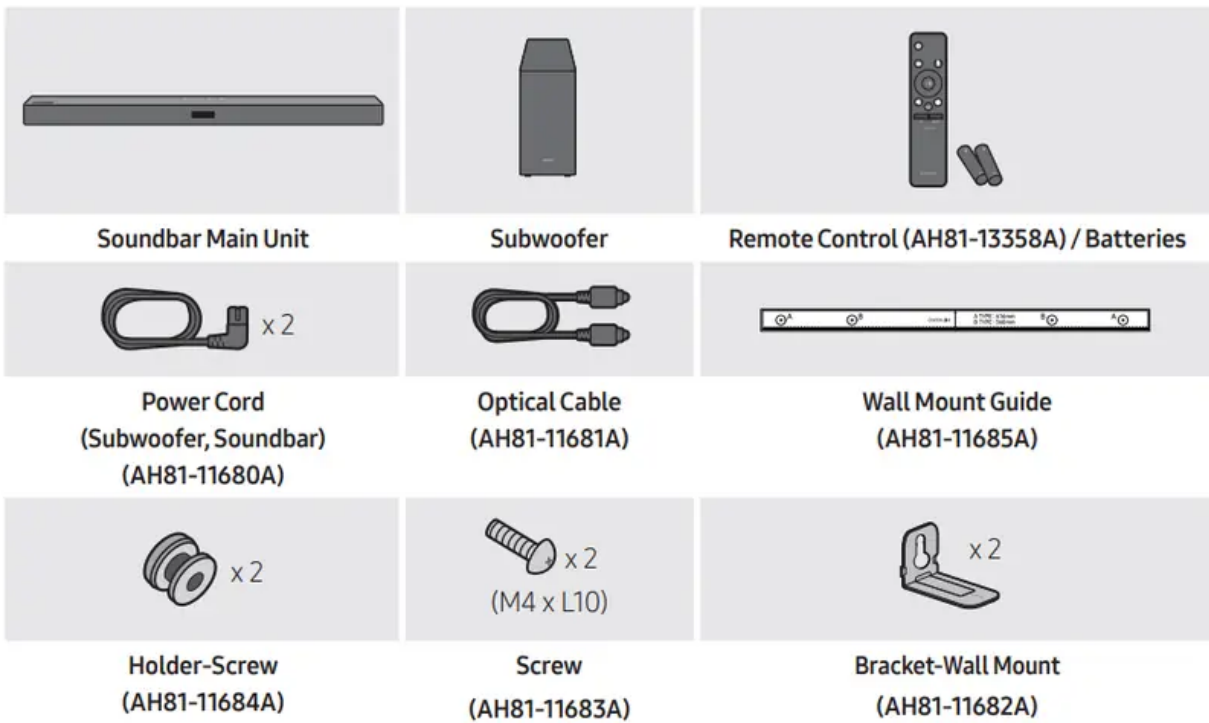

- For more information about the power supply and power consumption, refer to the label attached to the product. (Label: Bottom of the Soundbar Main Unit)
- To purchase additional components or optional cables, contact a Samsung Service Center or Samsung Customer Care.
- The appearance of the accessories may differ slightly from the illustrations above.

### Inserting Batteries before using the Remote Control (AA batteries X 2)

Slide the back cover in the direction of the arrow until it is completely removed. Insert 2 AA batteries (1.5V) oriented so that their polarity is correct. Slide the back cover back into position.

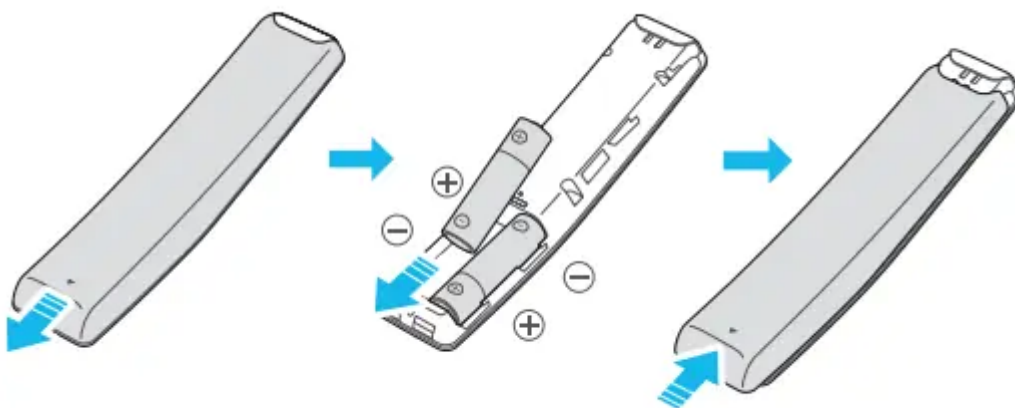

# PRODUCT OVERVIEW

Front Panel / Top Panel of the Soundbar

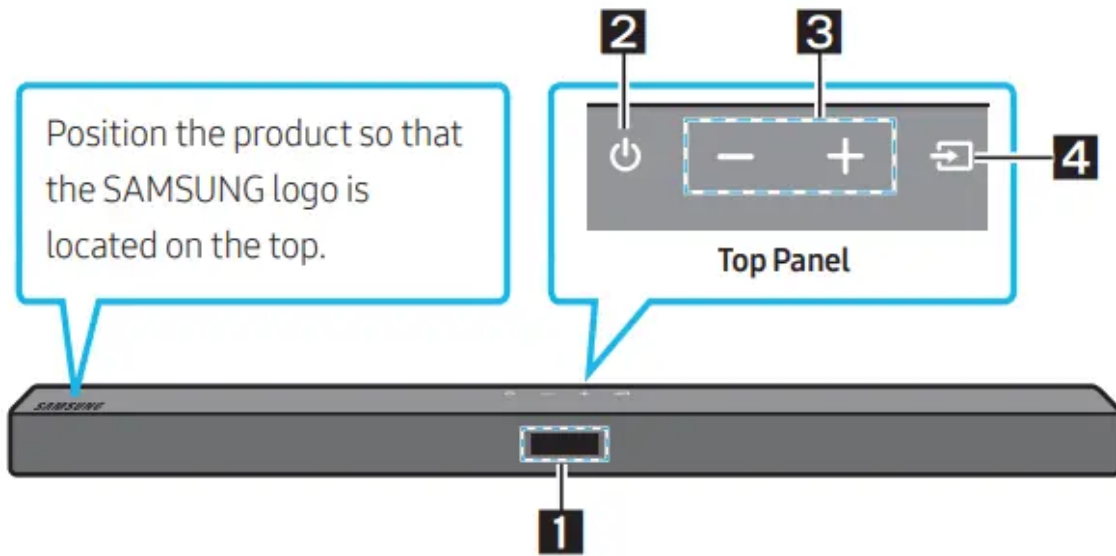

<p><b>1</b></p>	<p><b>Display</b> Displays the product's status and current mode.</p>								
<p><b>2</b></p>	<p><b>⏻ (Power) Button</b> Turns the power on and off.</p> <ul style="list-style-type: none"> <li>• <b>Auto Power Down Function</b> The unit turns off automatically in the following situations:             <ul style="list-style-type: none"> <li>- In <b>D.IN / BT / USB</b> Mode : If there is no audio signal for 18 minutes.</li> </ul> </li> </ul>								
<p><b>3</b></p>	<p><b>- + (Volume) Button</b> Adjusts the volume.</p> <ul style="list-style-type: none"> <li>• When adjusted, the volume level appears on the Soundbar's front display.</li> </ul>								
<p><b>4</b></p>	<p><b>↔ (Source) Button</b> Selects the source input mode.</p> <table border="1" data-bbox="247 1489 1149 1668"> <thead> <tr> <th>Input mode</th> <th>Display</th> </tr> </thead> <tbody> <tr> <td>Optical Digital input</td> <td>D.IN</td> </tr> <tr> <td>BLUETOOTH mode</td> <td>BT</td> </tr> <tr> <td>USB mode</td> <td>USB</td> </tr> </tbody> </table> <ul style="list-style-type: none"> <li>• To turn on "<b>BT PAIRING</b>" mode, change the source to "<b>BT</b>" mode, and then press and hold the <b>↔ (Source)</b> button for more than 5 seconds.</li> </ul>	Input mode	Display	Optical Digital input	D.IN	BLUETOOTH mode	BT	USB mode	USB
Input mode	Display								
Optical Digital input	D.IN								
BLUETOOTH mode	BT								
USB mode	USB								

- When you plug in the AC cord, the power button will begin working in 4 to 6 seconds.
- When you turn on this unit, there will be a 4 to 5 second delay before it produces sound.
- If you want to enjoy sound only from the Soundbar, you must turn off the TV's speakers in the Audio Setup menu of your TV. Refer to the owner's manual supplied with your TV.



## Bottom Panel of the Soundbar

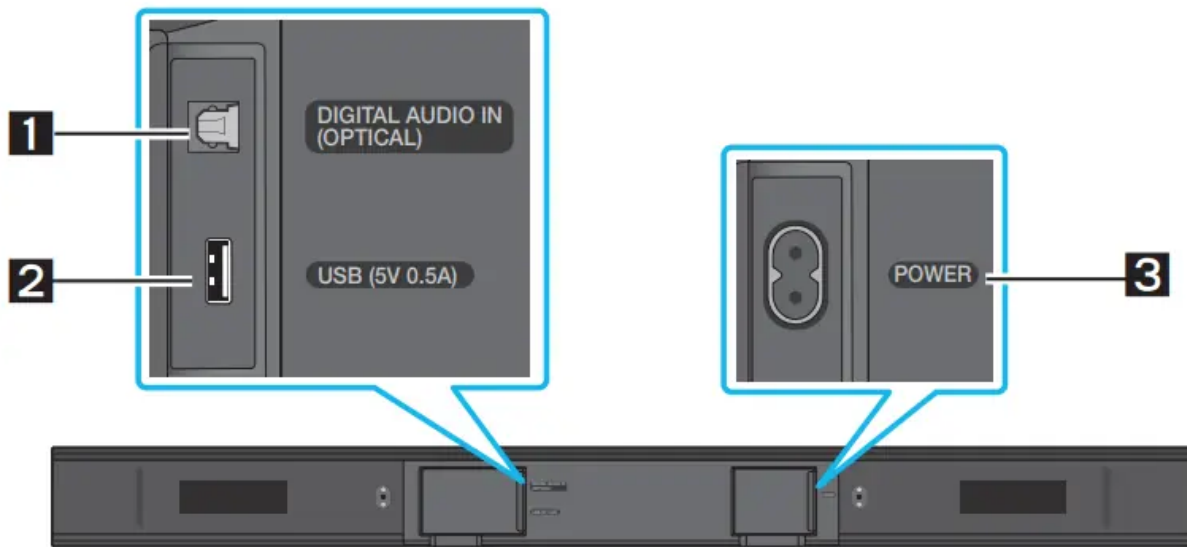

### 1 DIGITAL AUDIO IN (OPTICAL)

Connect to the digital (optical) output of an external device.

### 2 USB (5V 0.5A)

Connect a USB device here to play music files stored on the USB device through the Soundbar.

### 3 POWER

Connect the Soundbar's AC power cable.

- When disconnecting the power cord from a wall outlet, pull the plug. Do not pull the cable.
- Do not connect this unit or other components to an AC outlet until all connections between components are complete.

## CONNECTING THE SOUNDBAR

### Connecting Electrical Power

Use the power components to connect the Subwoofer and Soundbar to an electrical outlet in the following order:

1. Connect the power cord to the Subwoofer.
2. Connect the power cord to the Soundbar.

See the illustrations below.

- For more information about the required electrical power and power consumption, refer to the label attached to the product. (Label: Bottom of the Soundbar Main Unit)

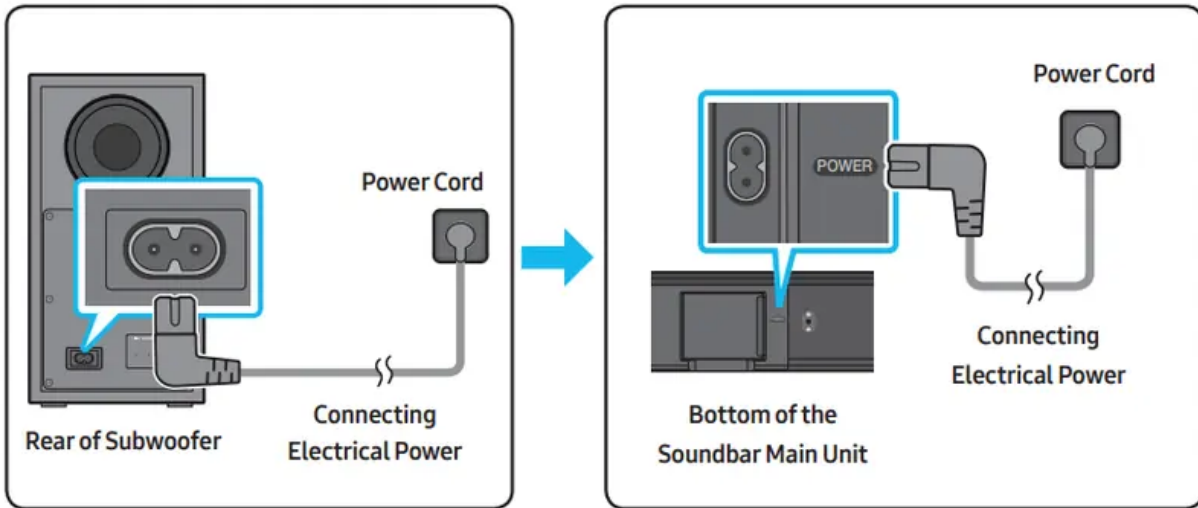

### **Connecting the Soundbar to the Subwoofer**

When the subwoofer is connected, you can enjoy rich bass sound.

#### **Automatic connection between the Subwoofer and the Soundbar**

When you turn the power on after connecting the power cables to the Soundbar and subwoofer, the subwoofer is automatically connected to the Soundbar.

- When auto pairing is complete, the blue indicators at the rear of the subwoofer turn on.

#### **LED Indicator Lights on the Rear of Subwoofer**

LED	Status	Description	Resolution
Blue	On	Successfully connected (normal operation)	-
	Blinking	Recovering the connection	Check if the power cable attached to the main Soundbar unit is connected properly or wait about 5 minutes. If blinking persists, try manually connecting the subwoofer. See page 7
Red	On	Standby (with the Soundbar main unit turned off)	Check if the power cable attached to the main Soundbar unit is connected properly.
		Connection failed	Connect again. See the instructions for manual connection on page 7.
Red and blue	Blinking	Malfunction	See the contact information for the Samsung Service Center in this manual.

### **Manually connecting the Subwoofer if automatic connection fails**

Before performing the manual connection procedure below:

- Check whether the power cables for the Soundbar and subwoofer are connected properly.
- Make sure that the Soundbar is turned on.

1. Press and hold ID SET on the rear of the subwoofer for at least 5 seconds.

- The red indicator on the rear of the subwoofer turns off and the blue indicator blinks.

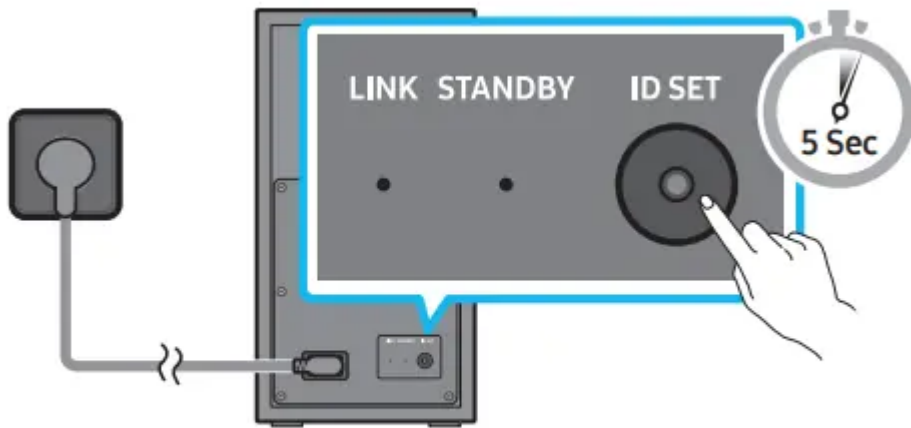

### Rear of Subwoofer

2. Press and hold the Up button on the remote control for at least 5 seconds.

- The ID SET message appears on the display of the Soundbar for a moment, and then it disappears.
- The Soundbar will automatically power on when ID SET is complete.

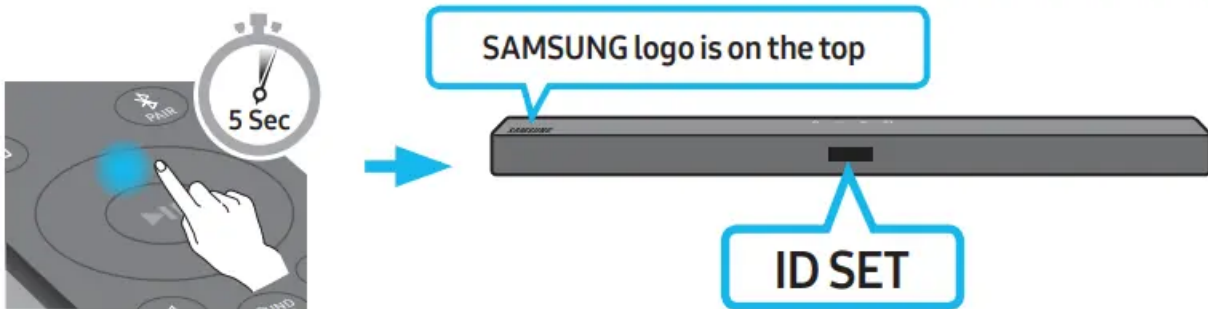

3. Check if the LINK LED is solid blue (connection complete)

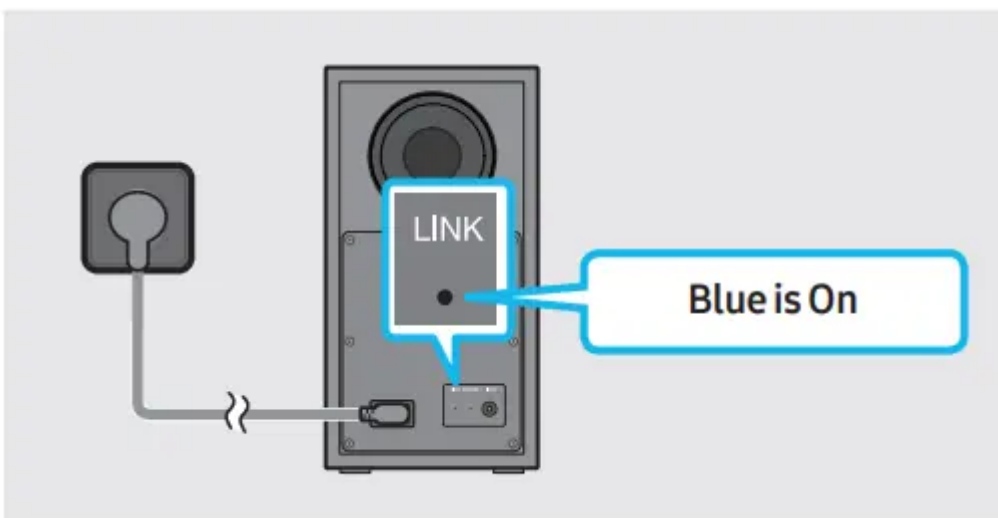

The LINK LED indicator stops blinking and glows a solid blue when a connection is established between the Soundbar and the Wireless Subwoofer.

## NOTES

- Do not connect the power cord of this product or your TV to a wall outlet until all connections between components are complete.
- Before moving or installing this product, be sure to turn off the power and disconnect the power cord.
- If the main unit is powered off, the wireless subwoofer will go into stand-by mode and the STANDBY LED on the rear of the sub-woofer will turn red after blinking blue several times.
- If you use a device that uses the same frequency (5.8GHz) as the Soundbar near the Soundbar, interference may cause some sound interruption.
- The maximum transmission distance of the main unit's wireless signal is about 32.8 ft (10 m), but may vary depending on your operating environment. If a steel-concrete or metallic wall is between the main unit and the wireless subwoofer, the system may not operate at all because the wireless signal cannot penetrate metal.

## PRECAUTIONS

- Wireless receiving antennas are built into the wireless subwoofer. Keep the unit away from water and moisture.
- For optimal listening performance, make sure that the area around the wireless subwoofer and the Wireless Receiver Module (sold separately) is clear of any obstructions.

## Connecting an SWA-9100S (Sold Separately) to your Soundbar

Expand to true wireless surround sound by connecting the Samsung Wireless Rear Speaker Kit (SWA-9100S, sold separately) to your Soundbar.

### 1. Connect the Wireless Receiver Module to 2 Surround Speakers.

- When connecting the speaker cable, connect the core wire to the speaker.

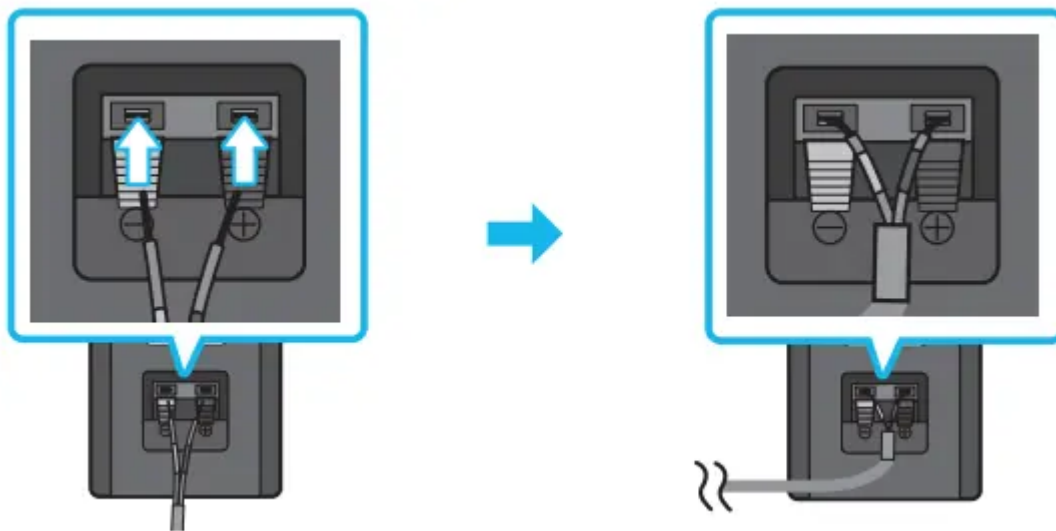

– The speaker cables are color coded.

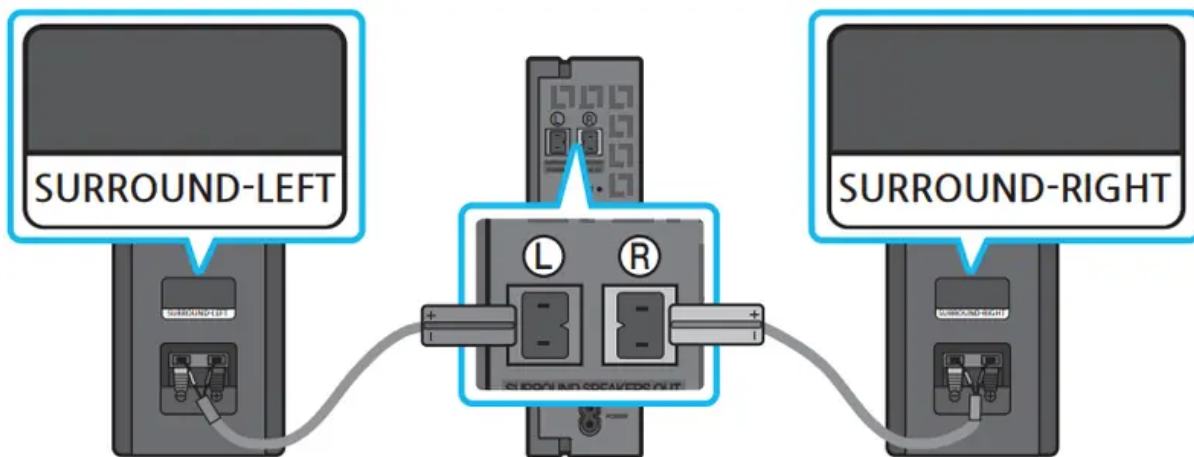

2. Check the standby status of the Wireless Receiver Module after plugging it into an electrical outlet.

- The LINK LED indicator (blue LED) on the Wireless Receiver Module blinks. If the LED does not blink, press the ID SET button on the back of the Wireless Receiver Module with a pen tip for 5~6 seconds until the LINK LED indicator blinks (in Blue). For more about the LED, please refer to the SWA-9100S user manual.

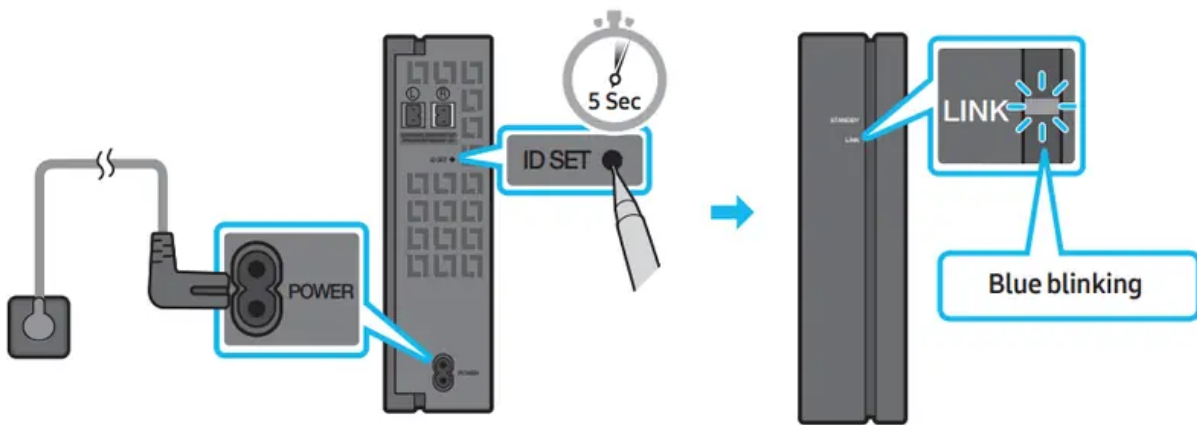

3. Press and hold the Up button on the remote control for at least 5 seconds.

- The ID SET message appears on the display of the Soundbar for a moment, and then it disappears.
- The Soundbar will automatically power on when ID SET is complete

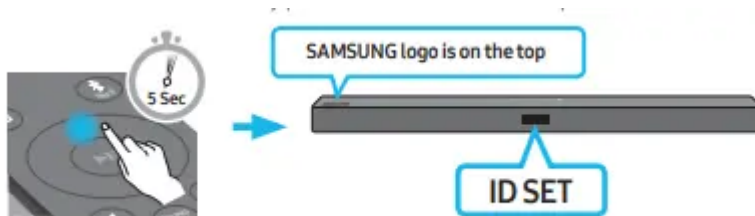

### ⚠ CAUTION

- If your Soundbar was playing music when it connects to the SWA-9100S, you may hear some stuttering from the woofer as the connection finalizes.

4. Check if the LINK LED is solid blue (connection complete).

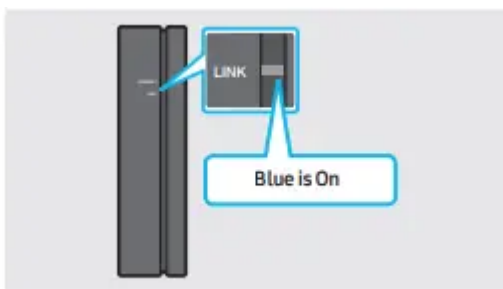

The LINK LED indicator stops blinking and glows a solid blue when a connection is established between the Soundbar and the Wireless Receiver Module.

5. If the SWA-9100S is not connected, repeat the procedure from Step 2

## CONNECTING TO YOUR TV

Hear TV sound from your Soundbar through wired or wireless connections.

- When the Soundbar is connected to selected Samsung TVs, the Soundbar can be controlled using the TV's remote control.

- This feature is supported by 2017 and later Samsung Smart TVs that support Bluetooth when you connect the Soundbar to the TV using an optical cable.

- This function also allows you to use the TV menu to adjust the sound field and various settings as well as the volume and mute.

## Method 1. Connecting with a Cable

When the audio in a broadcast is encoded in Dolby Digital and the “Digital Output Audio Format” on your TV is set to PCM, we recommend that you change the setting to Dolby Digital. When the setting on the TV is changed, you will experience better sound quality. (The TV menu may use different words for Dolby Digital and PCM depending on the TV manufacturer.)

### Connecting using an Optical Cable

Pre-connection Checklist

- When you use an optical cable and the terminals have covers, be sure to remove the covers.

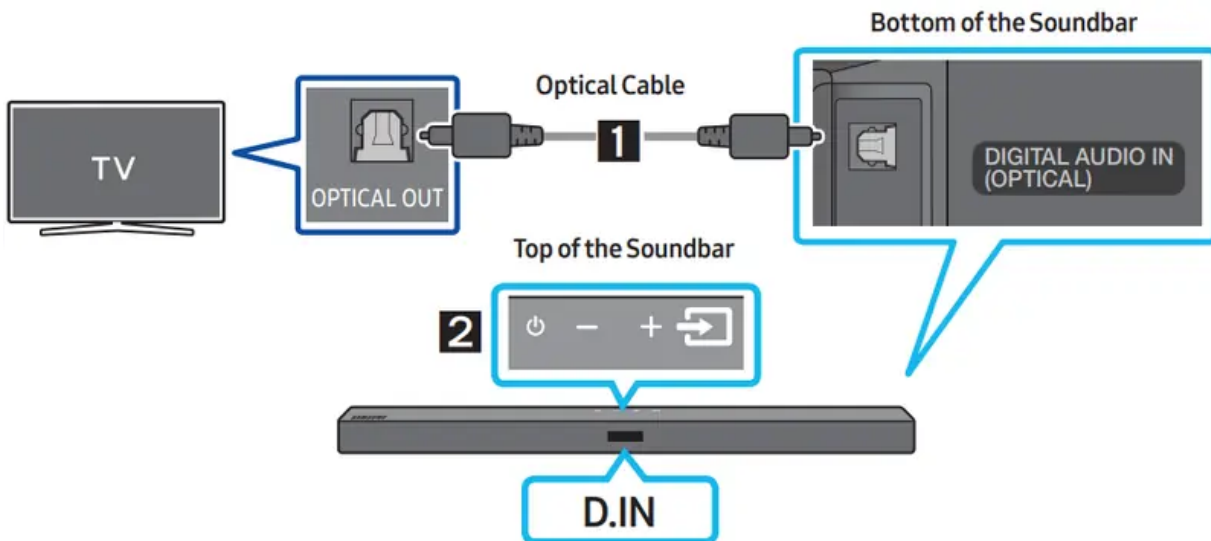

1. Connect the DIGITAL AUDIO IN (OPTICAL) port on the Soundbar to the OPTICAL OUT port of the TV with a digital optical cable.

2. Press the  (Source) button on the top panel or remote control, and then select the “D.IN” mode



## Method 2. Connecting Wirelessly

Connecting a TV via Bluetooth When a TV is connected using Bluetooth, you can hear stereo sound without the hassle of cabling.

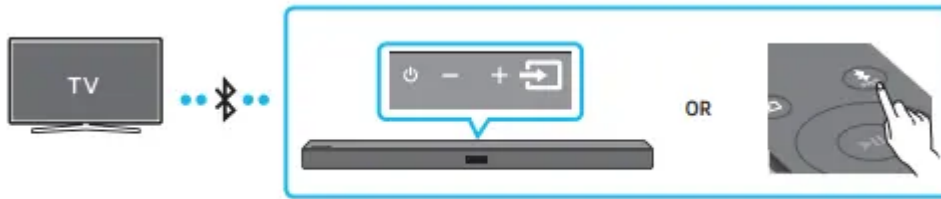
- Only one TV can be connected at a time.



### The initial connection

1. Press the  PAIR button on the remote control to enter the “BT PAIRING” mode. (OR)
  - a. Press the  (Source) button on the top panel and then select “BT”. “BT” changes to “BT PAIRING” in a few seconds automatically or changes to “BT READY” if there is a connect record.
  - b. When “BT READY” appears, press and hold the  (Source) button on the top panel of the Soundbar for more than 5 seconds to display “BT PAIRING”.
2. Select Bluetooth mode on the TV. (For more information, see the TV’s manual.)
3. Select “[AV] Samsung Soundbar A4-Series” from the list on TV’s screen. An available Soundbar is indicated with “Need Pairing” or “Paired” on the TV’s Bluetooth device list. To connect the TV to the Soundbar, select the message, and then establish a connection.
  - When the TV is connected, [TV Name] → “BT” appears on the Soundbar’s front display.
4. You can now hear TV sound from the Soundbar

### If the device fails to connect

- If a previously connected Soundbar listing (e.g. “[AV] Samsung Soundbar A4-Series”) appears in the list, delete it.
- Then repeat steps 1 through 3.

### NOTE

- After you have connected the Soundbar to your TV the first time, use the “BT READY” mode to reconnect.

### Disconnecting the Soundbar from the TV

Press the  (Source) button on the top panel or on the remote control and switch to any mode but “BT”.

- Disconnecting takes time because the TV must receive a response from the Soundbar. (The time required may differ, depending on the TV model.)
- To cancel the automatic Bluetooth connection between the Soundbar and TV, press the Left button on the remote control for 5 seconds with the Soundbar in “BT READY” status. (Toggle On → Off)

## CONNECTING AN EXTERNAL DEVICE

Connect to an external device via a wired connection or Bluetooth connection to play the external device's sound through the Soundbar.

### Connecting using an Optical Cable

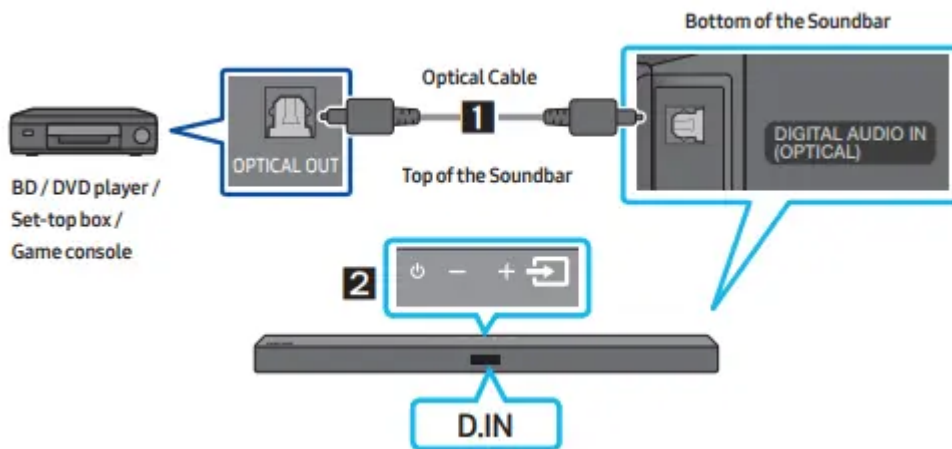

1. Connect DIGITAL AUDIO IN (OPTICAL) on the main unit to the OPTICAL OUT port of the Source Device using a digital optical cable.
2. Select “D.IN” mode by pressing the  (Source) button on the top panel or on the remote control.

## CONNECTING A USB STORAGE DEVICE

You can play music files located on USB storage devices through the Soundbar.

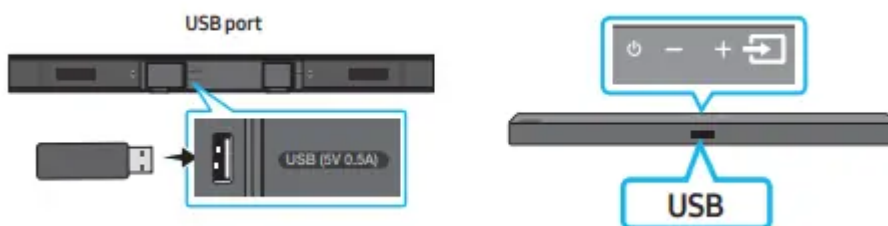

1. Connect the USB device to the USB port on the bottom of the product.

2. Press the  (Source) button on the top panel or on the remote control, and then select “USB”.

3. “USB” appears in the display screen.

4. Play music files from the USB storage device through the Soundbar.

- The Soundbar automatically turns off (Auto Power Down) if no USB device has been connected for more than 18 minutes.

### **File Format Type Compatibility list**

Extension	Codec	Sampling Rate	Bitrate
<b>*.mp3</b>	MPEG 1 Layer2	32kHz ~ 48kHz	32kbps~320kbps
	MPEG 1 Layer3	32kHz ~ 48kHz	32kbps~320kbps
	MPEG 2 Layer3	16kHz ~ 24kHz	8kbps~160kbps
	MPEG 2.5 Layer3	8kHz ~ 12kHz	8kbps~160kbps
<b>*.wma</b>	WMA7/8/9/STD	8kHz ~ 48kHz	32kbps~320kbps
<b>*.aac</b>	AAC	8kHz ~ 96kHz	< 1728kbps
	AAC-LC		
	HE-AAC		

<b>*.ogg</b>	Vorbis codec	(8, 16, 22.05, 32, 44.1, 48)kHz	unsupport ogg: 1. block size 0 < 256, block size 0 > 1024 2. block size 1 < 512, block size 1 > 4096 3. codebook counter > 64 4. codebook entry > 640 5. floor counter > 2 6. floor type 0 7. residua counter > 2 8. dimension != 2 9. mapping counter > 2 10. mode counter > 2 11. residue type != channel number
<b>*.flac</b>	-	8kHz ~ 192kHz	< 5Mbps
<b>*.wav</b>	PCM/LPCM/IMA_ ADPCM/MPEG/MULAW	8kHz ~ 192kHz	< 5Mbps
<b>*.AIFF</b>	Compression type: alwa, ulaw, sowl	(8, 16, 22.05, 32, 44.1, 48, 96, 192)kHz ≤ 2 channels	< 5Mbps

- If there are too many folders (about 256) and files (about 999) stored on the USB device, it may take the Soundbar some time to access and play files.
- Only USB Format Type FAT 32 is supported for USB storage device connection.

## CONNECTING A MOBILE DEVICE

### Connecting via Bluetooth

When a mobile device is connected using Bluetooth, you can hear stereo sound without the hassle of cabling.

- You cannot connect more than one Bluetooth device at a time

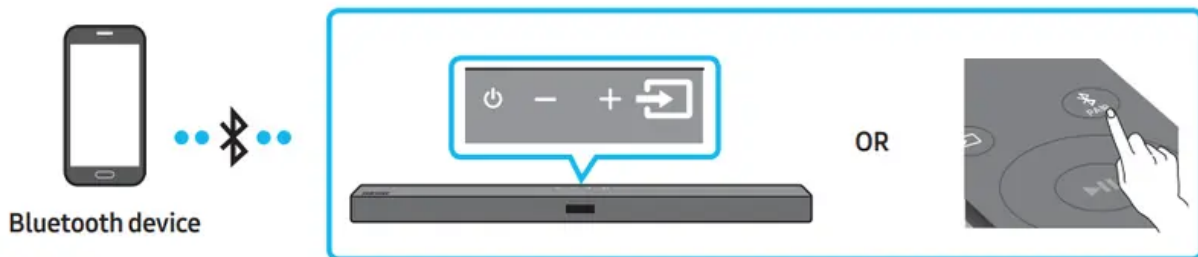

### The initial connection

1. Press the  PAIR button on the remote control to enter the “BT PAIRING” mode.

(OR)

a. Press the  (Source) button on the top panel and then select “BT”. “BT” changes to “BT PAIRING” in a few seconds automatically or changes to “BT READY” if there is a connect record.

b. When “BT READY” appears, press and hold the  (Source) button on the top panel of the Soundbar for more than 5 seconds to display “BT PAIRING”.

2. On your device, select “[AV] Samsung Soundbar A4-Series” from the list that appears.

- When the Soundbar is connected to the Bluetooth device, [Bluetooth Device Name] → “BT” appears in the front display.

3. Play music files from the device connected via Bluetooth through the Soundbar.

### **If the device fails to connect**

- If a previously connected Soundbar listing (e.g. “[AV] Samsung Soundbar A4-Series”) appears in the list, delete it.
- Then repeat steps 1 and 2.

### NOTE

- After you have connected the Soundbar to your mobile device the first time, use the “BT READY” mode to reconnect.

### **What is the difference between BT READY and BT PAIRING?**

- BT READY : In this mode, you can search for previously connected TVs or connect a previously connected mobile device to the Soundbar.
- BT PAIRING : In this mode, you can connect a new device to the Soundbar. (Press the PAIR button on the remote control or press and hold the  (Source) button on the top of the Soundbar for more than 5 seconds while the Soundbar is in “BT” mode.)

### **Bluetooth Power On (SOUND MODE)**

If a previously paired Bluetooth device tries to pair with the Soundbar when the Bluetooth Power On function is on and the Soundbar is turned off, the Soundbar turns on automatically.

1. Press and hold the SOUND MODE button for more than 5 seconds on the remote while the Soundbar is turned on.
2. “ON-BLUETOOTH POWER” appears on the Soundbar’s display

### **Disconnecting the Bluetooth device from a Soundbar**

You can disconnect a Bluetooth device from the Soundbar. For instructions, see the Bluetooth device’s user manual.

- The Soundbar will be disconnected.
- When the Soundbar is disconnected from the Bluetooth device, the Soundbar will display “BT DISCONNECTED” on the front display.

### **Disconnecting the Soundbar from the Bluetooth device**

Press the  (Source) button on the top panel or on the remote control, and then change to any mode except “BT”.

- Disconnecting takes time because the Bluetooth device must receive a response from the Soundbar. (Disconnection time may differ, depending on the Bluetooth device)
- When the Soundbar is disconnected from the Bluetooth device, the Soundbar will display “BT DISCONNECTED” on the front display.

### **NOTES**

- In Bluetooth connection mode, the Bluetooth connection will be lost if the distance between the Soundbar and the Bluetooth device exceeds 32.8 ft (10 m).
- The Soundbar automatically turns off after 18 minutes in the Ready state.

### **More About Bluetooth**





Bluetooth is a technology that enables Bluetooth-compliant devices to interconnect easily with each other using a short wireless connection.



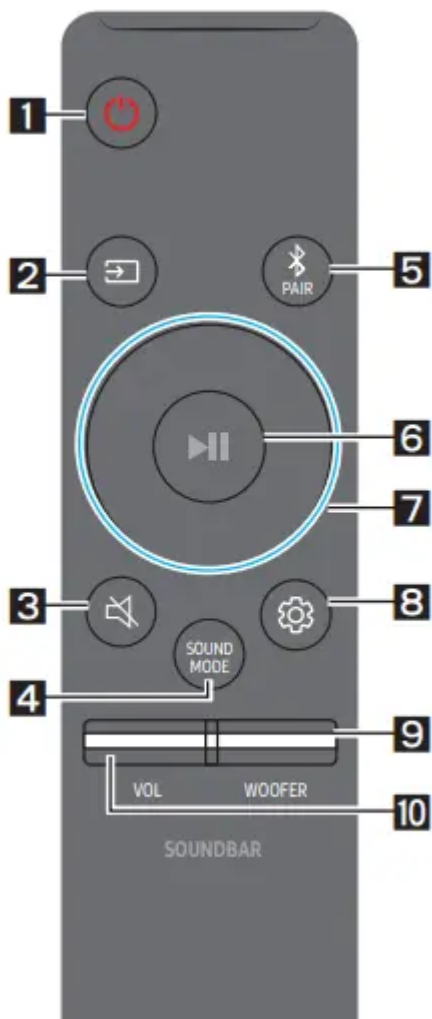

- A Bluetooth device may cause noise or malfunction, depending on usage, if:
  - A part of your body is in contact with the receiving/transmitting system of the Bluetooth device or the Soundbar.
  - It is subject to electrical variation from obstructions caused by a wall, corner, or office partition.
  - It is exposed to electrical interference from same frequency-band devices including medical equipment, microwave ovens, and wireless LANs.
- Pair the Soundbar with the Bluetooth device while they are close together.
- The further the distance between the Soundbar and Bluetooth device, the worse the quality is. If the distance exceeds the Bluetooth operational range, the connection is lost.
- In poor reception areas, the Bluetooth connection may not work properly.
- The Bluetooth connection only works when it is close to the unit. The connection will be automatically cut off if the Bluetooth device is out of range. Even within range, the sound quality may be degraded by obstacles such as walls or doors.
- This wireless device may cause electric interference during its operation.



## **USING THE REMOTE CONTROL**



### **How to Use the Remote Control**





<b>1</b>	 <p><b>Power</b></p>	Turns the Soundbar on and off.
<b>2</b>	 <p><b>Source</b></p>	Press to select a source connected to the Soundbar.
<b>3</b>	 <p><b>Mute</b></p>	Press the  ( <b>Mute</b> ) button to mute the sound. Press it again to unmute the sound.

4	 <b>SOUND MODE</b>	<p>Press to cycle through the available sound modes: <b>STANDARD, SURROUND SOUND, BASS BOOST, GAME, or ADAPTIVE</b>.</p> <ul style="list-style-type: none"> <li>- <b>STANDARD</b> Outputs the original sound.</li> <li>- <b>SURROUND SOUND</b> Provides a wider sound field than standard.</li> <li>- <b>BASS BOOST</b> Sound field mode with emphasis on bass sound.</li> <li>- <b>GAME</b> Provides stereoscopic sound to immerse you in the action while gaming.</li> <li>- <b>ADAPTIVE</b> Analyzes the content in real time and automatically provides an optimal sound field based on the characteristics of the content.</li> </ul>
		<ul style="list-style-type: none"> <li>• <b>DRC (Dynamic Range Control)</b> Lets you apply dynamic range control to Dolby Digital tracks. Press and hold the <b>SOUND MODE</b> button for more than 5 seconds while the Soundbar is powered off to turn DRC (Dynamic Range Control) on or off. With the DRC turned on, loud sound is reduced. (The sound may be distorted.)</li> <li>• <b>Bluetooth Power</b> This feature automatically turns the Soundbar on when it receives a connection request from a previously connected TV or Bluetooth device. The setting is On by default. <ul style="list-style-type: none"> <li>- Press and hold the <b>SOUND MODE</b> button for more than 5 seconds to turn off the Bluetooth Power function.</li> </ul> </li> </ul>
5	 <b>Bluetooth PAIR</b>	<p>Press the  <b>PAIR</b> button. "<b>BT PAIRING</b>" appears in the Soundbar's display. You can connect the Soundbar to a new Bluetooth device in this mode by selecting the Soundbar from the Bluetooth device's search list.</p>
6	 <b>Play / Pause</b>	<p>Press the  button to pause a music file temporarily. When you press the button again, the music file plays.</p>

7	 <p>Up/Down/ Left/Right</p>	 <p>Press the indicated areas to select Up/Down/Left/Right.</p> <p>Press Up/Down/Left/Right on the button to select or set functions.</p> <ul style="list-style-type: none"> <li>• <b>Repeat</b> To use the Repeat function in "USB" mode, press the <b>Up</b> button.</li> <li>• <b>Music Skip</b> Press the <b>Right</b> button to select the next music file. Press the <b>Left</b> button to select the previous music file.</li> <li>• <b>ID SET</b> Press and hold the <b>Up</b> button for 5 seconds to complete <b>ID SET</b> (when connecting to a wireless subwoofer or wireless rear speakers).</li> </ul>
---	--	--

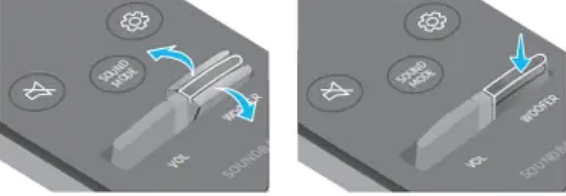
8	 <p>Sound Control</p>	<p>When pressed, the settings <b>TREBLE</b>, <b>BASS</b>, and <b>AUDIO SYNC</b> are displayed in sequence. The desired settings can be adjusted using the <b>Up/Down</b> buttons.</p> <ul style="list-style-type: none"> <li>• To control the volume of the treble or bass sound, press the  (<b>Sound Control</b>) button to select <b>TREBLE</b> or <b>BASS</b> and then adjust the volume between -6~+6 by using the <b>Up/Down</b> buttons.</li> <li>• Press and hold the  (<b>Sound Control</b>) button for about 5 seconds to adjust the sound for each frequency band. 150Hz, 300Hz, 600Hz, 1.2kHz, 2.5kHz, 5kHz, and 10kHz are selectable using the <b>Left/Right</b> buttons and each can be adjusted to a setting between -6 to +6 using the <b>Up/Down</b> buttons. (Make sure the Sound mode is set to "STANDARD".)</li> <li>• If the video on the TV and audio from the Soundbar are not synchronized, press the <b>Sound Control</b> button to select <b>AUDIO SYNC</b> and then set the audio delay between 0~300 milliseconds by using the <b>Up/Down</b> buttons. (Not available in "BT" and "USB" mode.)</li> <li>• <b>AUDIO SYNC</b> is only supported for some functions.</li> </ul>
---	--	--

9	 <p>WOOFER (BASS) LEVEL</p>	 <p>Push the button up or down to adjust the level of the woofer (bass) to -12 or between -6 to +6. To set the woofer (bass) volume level to 0 (Default), press the button.</p>
---	--	--

10	 <p>VOL (Volume)</p>	 <p>Push the button up or down to adjust the volume.</p> <ul style="list-style-type: none"> <li>• <b>Mute</b> Press the <b>VOL</b> button in to mute the sound. Press it in again to unmute the sound.</li> </ul>
----	---	--







# Adjusting the Soundbar volume with a TV remote control

Adjust the Soundbar volume using the TV's remote control.

- This function can be used with IR remote controls only. Bluetooth remote controls (remote controls that require pairing) are not supported.
- Set the TV speaker to External Speaker to use this function.
- Manufacturers supporting this function: VIZIO, LG, Sony, Sharp, PHILIPS, PANASONIC, TOSHIBA, Hisense, RCA

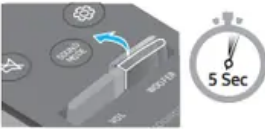
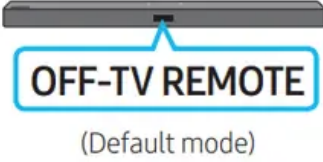
1. Turn Off the Soundbar.

2. Push up and hold the WOOFER button for 5 seconds. Each time you push the WOOFER button up and hold it for 5 seconds, the mode switches in the following order: "OFF-TV REMOTE" (Default mode), "SAMSUNG-TV REMOTE", "ALL-TV REMOTE".

Remote Control Button	Display	Status
	 (Default mode)	Disable the TV remote control.
		Enable a Samsung TV's IR remote control.
		Enable a third-party TV's IR remote control.

## Using the Hidden Buttons (Buttons with more than one function)

Hidden Button		Reference page
Remote Control Button	Function	
WOOFER (Up)	TV remote control On/Off (Standby)	page 23
Left	TV Auto connect On/Off (BT Ready)	page 13
Up	ID SET (Standby)	page 21
 (Sound Control)	7 Band EQ (Press and hold 5 seconds)	page 22
	Reset (Press and hold 10 seconds)	page 28
SOUND MODE	DRC ON/OFF (Standby)	page 21
	Bluetooth Power	page 21

## Output specifications for the different sound effect modes



Effect		Input	Output	
			Without Wireless Rear Speaker Kit	With Wireless Rear Speaker Kit
 <b>SOUND MODE</b>	STANDARD	2.0 ch	2.1 ch	4.1 ch
		5.1 ch	2.1 ch	4.1 ch
	SURROUND SOUND	2.0 ch	2.1 ch	4.1 ch
		5.1 ch	2.1 ch	4.1 ch
	BASS BOOST	2.0 ch	2.1 ch	4.1 ch
		5.1 ch	2.1 ch	4.1 ch
	GAME	2.0 ch	2.1 ch	4.1 ch
		5.1 ch	2.1 ch	4.1 ch
	ADAPTIVE	2.0 ch	2.1 ch	4.1 ch
		5.1 ch	2.1 ch	4.1 ch

- The Samsung Wireless Rear Speaker Kit can be purchased separately. To purchase a Kit, contact the vendor you purchased the Soundbar from

## INSTALLING THE WALL MOUNT

### Installation Precautions

- Install on a vertical wall only.
- Do not install in a place with high temperature or humidity.
- Verify whether the wall is strong enough to support the product's weight. If not, reinforce the wall or choose another installation point.
- Purchase and use the fixing screws or anchors appropriate for the kind of wall you have (plaster board, iron board, wood, etc.). If possible, fix the support screws into wall studs.
- Purchase wall mounting screws according to the type and thickness of the wall you want to mount the Soundbar on.
  - Diameter: M5
  - Length: 1 3/8 inches (35 mm) or longer recommended.
- Connect cables from the unit to external devices before you install the Soundbar on the wall.
- Make sure the unit is turned off and unplugged from the power source before you install it. Otherwise, it may cause an electric shock.

### Wallmount Components



### Wall Mount Guide (AH81-11685A)



**Holder-Screw**  
(AH81-11684A)

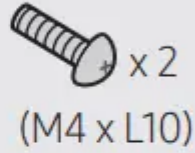

**Screw**  
(AH81-11683A)



### Bracket-Wall Mount (AH81-11682A)

1. Place the Wall Mount Guide against the wall surface.
  - The Wall Mount Guide must be level.
  - If your TV is mounted on the wall, install the Soundbar at least 2 inches (5 cm) below the TV.



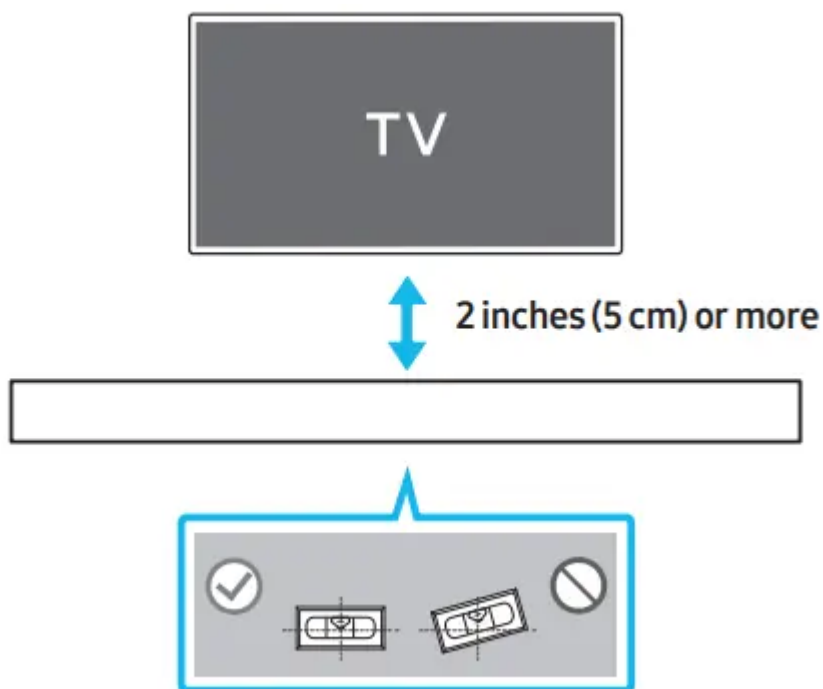

2. Align the Wall Mount Guide's Center Line with the center of your TV (if you are mounting the Soundbar below your TV), and then fix the Wall Mount Guide to the wall using tape.

- If you are not mounting below a TV, place the Center Line in the center of the installation area.

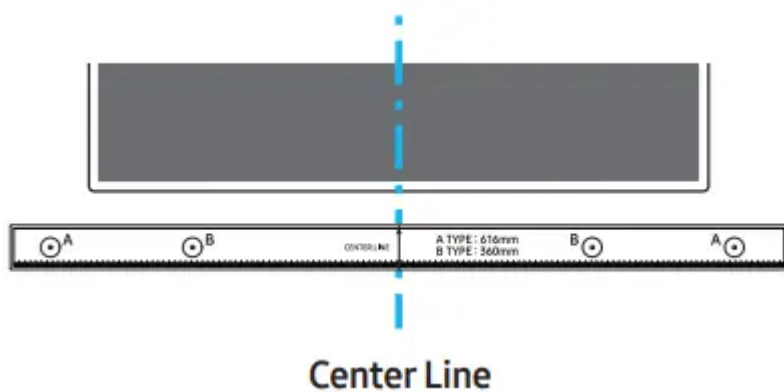

3. Push a pen tip or sharpened pencil tip through the center of the B-TYPE images on each end of the Guide to mark the holes for the supporting screws, and then remove the Wall Mount Guide.

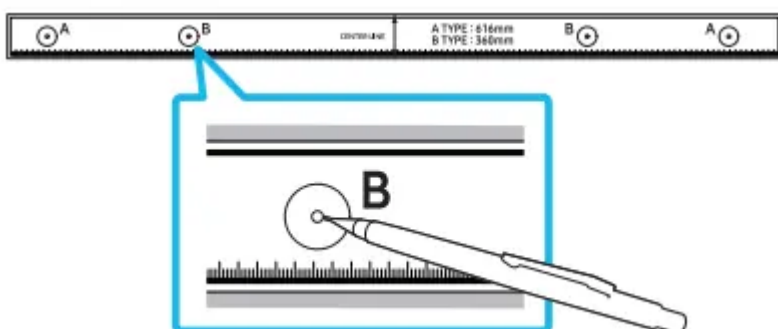

4. Using an appropriately sized drill bit, drill a hole in the wall at each marking.

- If the markings do not correspond to the positions of studs, make sure you insert appropriate anchors into the holes before you insert the support screws. If you use anchors, make sure the holes you drill are large enough for the anchors you use.

5. Push a screw (not supplied) through each Holder-Screw, and then screw each screw firmly into a support screw hole.

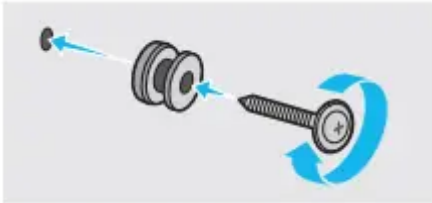

6. Install the 2 Bracket-Wall Mounts in the correct orientation on the bottom of the Soundbar using 2 Screws.

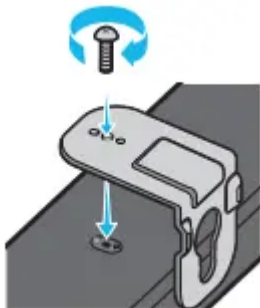

- When assembling, make sure the hanger part of the Bracket-Wall Mounts are located behind the rear of the Soundbar.

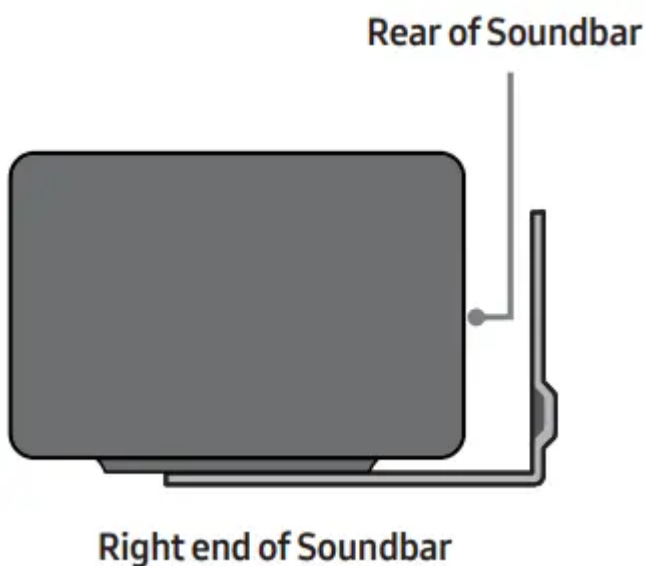

7. Install the Soundbar with the attached Bracket-Wall Mounts by hanging the Bracket-Wall Mounts on the Holder-Screws on the wall.

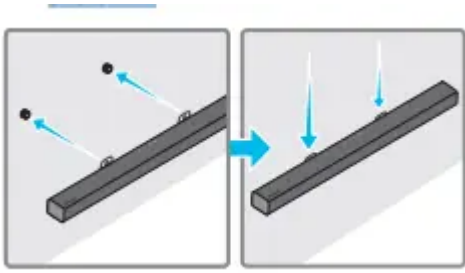

8. Slide the Soundbar down as shown below so that the Bracket-Wall Mounts rest securely on the Holder-Screws.

- Insert the Holder-Screws into the wide (bottom) part of the Bracket-Wall Mounts, and then slide the Bracket-Wall Mounts down so that the Bracket-Wall Mounts rest securely on the Holder-Screws.

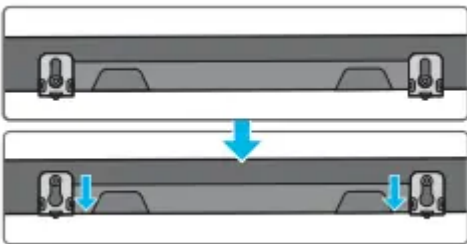

## PLACING THE SOUNDBAR ON A TV STAND

Place the Soundbar on a TV stand

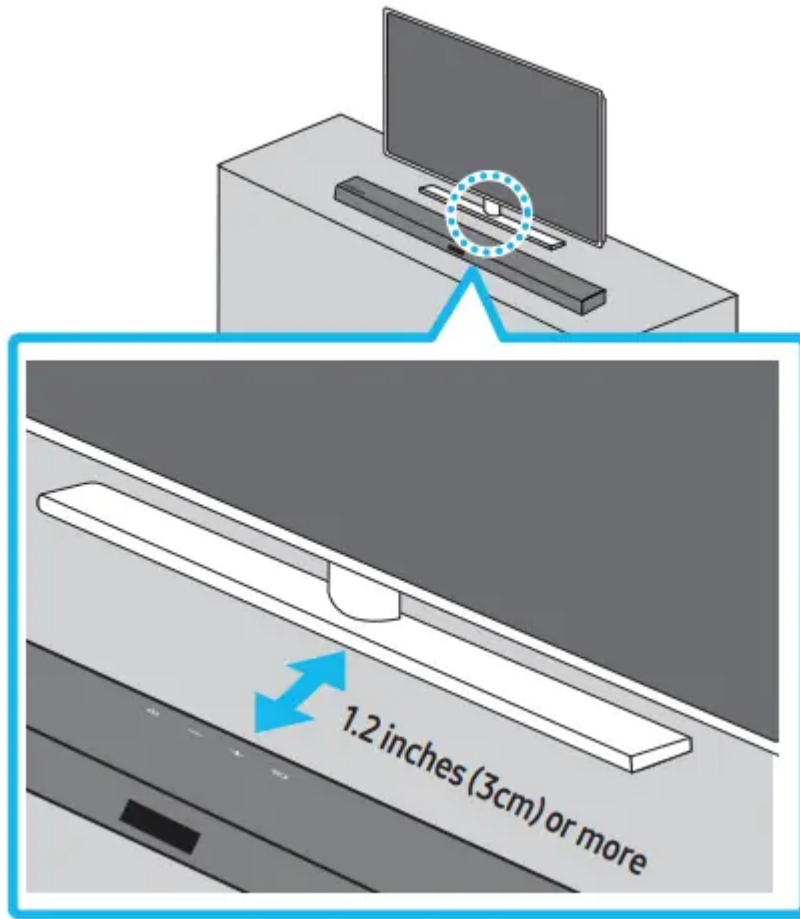

As illustrated in the image, align the center of the Soundbar with the center of the TV, carefully place the Soundbar onto the TV stand. For optimal sound quality, position the Soundbar at least 1.2 inches (3 cm) away from the TV front.

#### **NOTE**

- Make sure the Soundbar is placed on a flat and solid surface

## **SOFTWARE UPDATE**

Samsung may offer updates for the Soundbar's system firmware in the future.

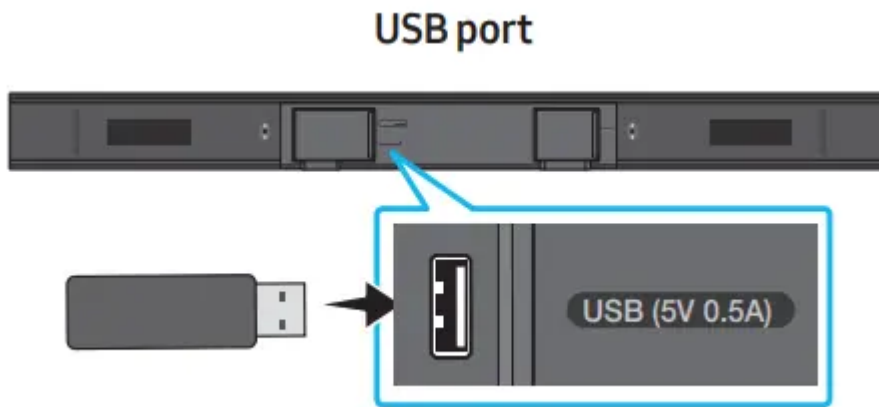

If an update is offered, you can update the firmware by connecting a USB device with the firmware update stored on it to the USB port on your Soundbar.

Then, select the product type or enter the model number of your Soundbar, select the Software & Apps option, and then Downloads. Note that the option names can vary.

### Update Procedure

**Important:** The update function erases all user settings. We recommend you write down your settings so that you can easily reset them after the update. Note that updating the firmware resets the subwoofer connection too

1. Connect a USB thumb drive to the USB port on your computer. Important: Make sure there are no music files on the USB thumb drive. This may cause the firmware update to fail.
2. Go to Samsung web on your computer → select Enter Model Number and enter the model of your Soundbar. Select manuals and downloads and download the latest software file.
3. Save the downloaded software to a USB stick and select “Extract Here” to unzip the folder.
4. Turn off the Soundbar and connect the USB stick containing the software update to the USB port.
5. Turn on the Soundbar and change the source to “USB” mode. Within 3 minutes, “UPDATE” is displayed and the update begins.
6. When the update complete, the Soundbar turns off. Press the  (Sound Control) button on the remote control for 10 seconds when Soundbar is power on state. “INIT” → “OK” will appear on the display and then the Soundbar restarts. The update is complete.
  - This product has a DUAL BOOT function. If the firmware fails to update, you can update the firmware again. Soundbar AC code on when USB in with update file. Then update again but VFD no show anything, It will update finish after 2min.
7. Restore your settings on the Soundbar.

## TROUBLESHOOTING

Refer to the table below if this product does not function properly. If the problem you are experiencing is not listed below or if the instructions below do not help, turn off the product, disconnect the power cord, and contact Samsung Electronics at 1-800-SAMSUNG (1-800-726-7864).

### **Soundbar does not turn on.**

; Check whether the power cord of the Soundbar is correctly inserted into the outlet.

### **Soundbar works erratically.**

; After removing the power cord, insert it again.

; Remove the power cord from the external device and try again.

; If there is no signal, the Soundbar automatically turns off after a certain period of time. Turn on the power. (See page 3.)

### **In case the remote control does not work.**

; Point the remote directly at the Soundbar.

; Replace the batteries with new ones.

### **Soundbar does not output any sound**

. ; The volume of the Soundbar is too low or muted. Adjust the volume.

; When any external device (STB, Bluetooth device, mobile device, etc.) is connected, adjust the volume of the external device.

; For sound output of the TV, select Soundbar. (Samsung TV: Home (🏠) → Settings (⚙️) → Sound → Sound Output → Select Soundbar)

; The cable connection to the Soundbar may not be loose. Remove the cable and connect again.

; Remove the power cord completely, reconnect, and turn the power on.

; Reset the product and try again. (See page 28.)

### **Subwoofer does not output any sound.**

; Check whether the LED indicator on the rear of the Subwoofer is on in blue. Reconnect the Soundbar and Subwoofer if the indicator is blinking slowly in blue or turned red. (See page 7.)

; You may experience an issue if there is an obstacle between the Soundbar and Subwoofer. Move devices to an area away from obstacles.

; Other devices sending radio frequency signals in proximity may interrupt the connection. Keep your speaker away from such devices.



; Remove and reconnect the power plug.

### **The Subwoofer volume is too low.**

; The original volume of the content you are playing may be low. Try adjusting the Subwoofer level. (See page 22.)



; Bring the Subwoofer speaker closer to you.

### **Soundbar does not connect via Bluetooth.**

; When connecting a new device, switch to “BT PAIRING” for connection. (Press the  PAIR button on the remote control or press the  (Source) button on the body for at least 5 seconds.)

; If the Soundbar is connected to another device, disconnect that device first to switch the device.

; Reconnect it after removing the Bluetooth speaker list on the device to connect. (Samsung

TV: Home (  ) → Settings (  ) → Sound → Sound Output → Bluetooth Speaker List)

; Remove and reconnect the power plug, then try again. ; Reset the product and try again. (See page 28.)

### **Sound drops out when connected via Bluetooth.**

; Sounds may be breaking due to interference by radio frequency or electronic devices nearby. Keep such devices away from the Soundbar to avoid radio interference. Example: microwave ovens.

; If your device that is connected via Bluetooth moves too far away from the Soundbar, it may cause the sound to drop out. Move the device closer to the Soundbar.

; If a part of your body is in contact with the Bluetooth transceiver or the product is installed on metal furniture, sound may drop out. Check the installation environment and conditions for use.

### **Soundbar does not turn on automatically with the TV.**

; When you turn off the Soundbar while watching TV, power synchronization with the TV is disabled. First turn off the TV.

#### **Warning**

This content is compiled from multiple sources and is provided for reference purposes only. It may not be complete or fully applicable to all situations. If you are unable to resolve your issue, please contact the product manufacturer or an authorized service provider for official support.

---

Document generated by [ManualsFile](#)