

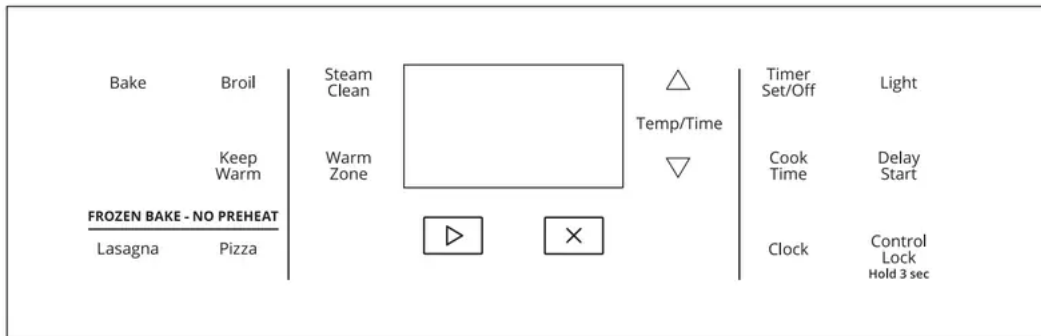



FEATURE GUIDE



Keypad	Feature	Instructions
CLOCK	Clock	<p>The Clock uses a 12 hour cycle.</p> <ol style="list-style-type: none"> 1. Check that the oven is off. 2. Press CLOCK. 3. Press the Temp/Time up or down arrow keypad to set the hours. Press CLOCK to switch to the minutes. Press the Temp/Time up or down arrow keypad to set the minutes. 4. Press CLOCK or the Start keypad
LIGHT	Oven cavity light	Press LIGHT to turn the light on and off
TIMER SET/ OFF	Oven timer	<p>The Timer can be set in hours or minutes up to 9 hours and 59 minutes.</p> <ol style="list-style-type: none"> 1. Press TIMER SET/OFF. 2. Press the Temp/Time up or down arrow keypad to set the length of time. 3. Press the Start keypad to begin the countdown. If enabled, end-of-cycle tones will sound at end of countdown. 4. Press TIMER SET/OFF to cancel the Timer. Do not press the Cancel keypad because the oven will turn off.
START 	Cooking start	The Start keypad begins any oven function. If the Start keypad is not pressed within seconds, a tone will sound and The Start keypad will blink until pressed or canceled. If Start is not pressed within 30 seconds after pressing a keypad, the function is canceled and the time of day is displayed
CANCEL 	Range function	The Cancel keypad stops any function except the Timer, Warm Zone, and Oven Control Lockout.
TEMP/TIME	Temperature and time adjust	The Temp/Time up and down arrow keypads are used to adjust time and temperature settings
BAKE		<ol style="list-style-type: none"> 1. Press BAKE.

Baking and
roasting

2. Press the Temp/Time up or down arrow keypad until desired temperature is reached. A tone will sound if the minimum or maximum temperature is reached.
3. Press the Start keypad.
4. To change the temperature, repeat Step 2. Press the Start keypad.
5. Press the Cancel keypad when finished.

<p>FROZEN BAKE</p>	<p>Prepackaged food</p>	<ol style="list-style-type: none"> 1. Position the food on a flat rack in the oven on rack 3 or 4. See the “Positioning Racks and Bakeware” section. NOTE: Cook only one package of frozen food at a time when using Frozen Bake™ Technology. 2. Press FROZEN BAKE LASAGNA or PIZZA. 3. Press the Temp/Time up or down arrow keypad to set the temperature as recommended on the food packaging. 4. Press COOK TIME. 5. Press the Temp/Time up or down arrow keypad to set the maximum cook time as recommended on the food packaging. 6. Press the Start keypad. The range will calculate the best cook time based on the current oven temperature. NOTE: The cook time that appears in the display is the estimated required cook time as calculated by the oven control. It may be different than the time you entered. A beep will alert you to check the food’s doneness with at least 2 minutes remaining on the timer. Follow the prompts on the display to select more time if desired. 7. Press the Start keypad to start the calculated time. 8. At the end of the cook time, a beep will alert you to check the food’s doneness. When “End” is displayed and  is flashing, you can add more time, if desired. Press the up or down arrow keypad to set the time, then press START. If more time is not added, the bake element will turn off. NOTE: Pressing Cancel will exit the Frozen Bake™ cycle. 9. Press the Cancel keypad when finished.
<p>BROIL</p>	<p>Broiling</p>	<ol style="list-style-type: none"> 1. Position cookware in the oven and close the oven door. 2. Press BROIL. 3. Press the Temp/Time up or down arrow keypad until desired temperature is reached. A tone will sound if the minimum or maximum temperature is reached.

		<ol style="list-style-type: none"> 4. Press the Start keypad. 5. To change the temperature, repeat Step 3 and press the Start keypad. 6. Press the Cancel keypad when finished.
KEEP WARM	Hold warm	<p>Food must be at serving temperature before placing it in the warmed oven.</p> <ol style="list-style-type: none"> 1. Press KEEP WARM. 2. Press the Temp/Time up or down arrow keypad until desired temperature is reached. A tone will sound if the minimum or maximum temperature is reached. 3. Press the Start keypad. 4. Press the Cancel keypad when finished.
WARM ZONE	Warming zone	<p>Press WARM ZONE to select the warming element on the cooktop. Press the Start keypad.</p> <p>Press WARM ZONE again to turn off the warming element.</p>
DELAY START	Delayed start	<p>Delay Start is used to enter the starting time for an oven function with a delayed start.</p> <p>Delay Start should not be used for foods such as breads and cakes because they may not bake properly.</p> <p>To set a Timed Cook or a Delayed Timed Cook, see “Cook Time” section</p>
COOK TIME	Timed cooking	<p>Cook Time allows the oven to be set to turn on at a certain time of day, cook for a set length of time, and/or shut off automatically.</p> <p>To set a Timed Cook or a Delayed Timed Cook, see “Cook Time” section</p>
STEAM CLEAN	Steam cleaning cycle	<p>See the “Steam Clean” section for more information and helpful tips for the Steam Clean feature.</p> <ol style="list-style-type: none"> 1. Remove all racks and accessories from the oven cavity. 2. Press STEAM CLEAN.



		<ol style="list-style-type: none"> 3. Add 12 oz (355 mL) of distilled or filtered water to the oven bottom. 4. Press the Start keypad. After 50 minutes, "END" will appear in the display to signal the end of the cycle. 5. Press the Cancel keypad to clear the display. 6. Remove any excess water with a sponge or cloth and wipe down oven interior.
CONTROL LOCK (Hold 3 sec)	Oven and cooktop control lockout	<ol style="list-style-type: none"> 1. Check that the oven and cooktop are off. 2. Press and hold CONTROL LOCK for 3 seconds. 3. A tone will sound and a lock will be displayed. 4. Repeat to unlock. No keypads will function with the controls locked

COOKTOP USE

The control knobs can be set to anywhere between Hi and Melt.

Push in and turn to setting.

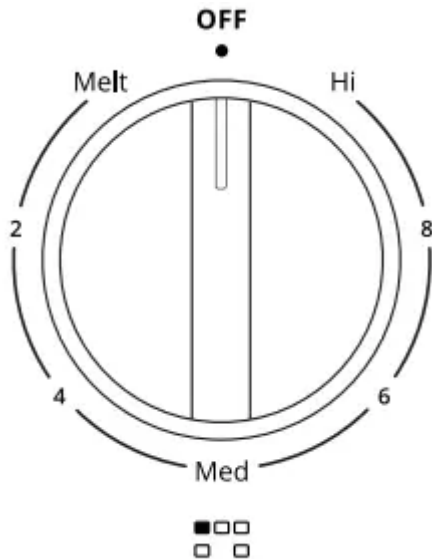

Ceramic Glass

The surface cooking area will glow red when an element is on.

Some parts of the surface cooking area may not glow red when an element is on. This is normal operation. It will also randomly cycle off and back on again, even while on High, to keep the cooktop from extreme temperatures.

It is normal for the surface of light-colored ceramic glass to appear to change color when surface cooking areas are hot. As the glass cools, it will return to its original color.

Clean the cooktop after each use to help avoid scratches, pitting, abrasions, and to condition the glass surface. Ceramic glass cooktop cleaner and a cooktop scraper are also recommended for stubborn soils. Do not use abrasive cleaners, cleaning pads, or harsh chemicals for cleaning. The Cooktop Care Kit Part

Number 31605 contains all of the items needed to clean and condition your ceramic glass cooktop. Refer to the "Range Care" section for additional information.

IMPORTANT: To avoid permanent damage to the cooktop surface and to make soils easier to remove, clean the cooktop after each use to remove all soils.

- Avoid storing jars or cans above the cooktop. Dropping a heavy or hard object onto the cooktop could crack the cooktop.
- To avoid damage to the cooktop, do not leave a hot lid on the cooktop. As the cooktop cools, air can become trapped between the lid and the cooktop and the ceramic glass could break when the lid is removed.
- For foods containing sugar in any form, clean up all spills and soils as soon as possible. Allow the cooktop to cool down slightly. Then, while wearing oven mitts, remove the spills using a scraper while the surface is still warm. If sugary spills are allowed to cool down, they can adhere to the cooktop and can cause pitting and permanent marks.
- To avoid scratches, do not slide cookware or bakeware across the cooktop. Aluminum or copper bottoms and rough finishes on cookware or bakeware could leave scratches or marks on the cooktop.
- Do not cook popcorn in prepackaged aluminum containers on the cooktop. They could leave aluminum marks that cannot be removed completely.
- To avoid damage to the cooktop, do not allow objects that could melt, such as plastic or aluminum foil, to touch any part of the cooktop.
- To avoid damage to the cooktop, do not use the cooktop as a cutting board.
- Use cookware about the same size as the surface cooking area. Cookware should not extend more than 1/2" (1.3 cm) outside the area.

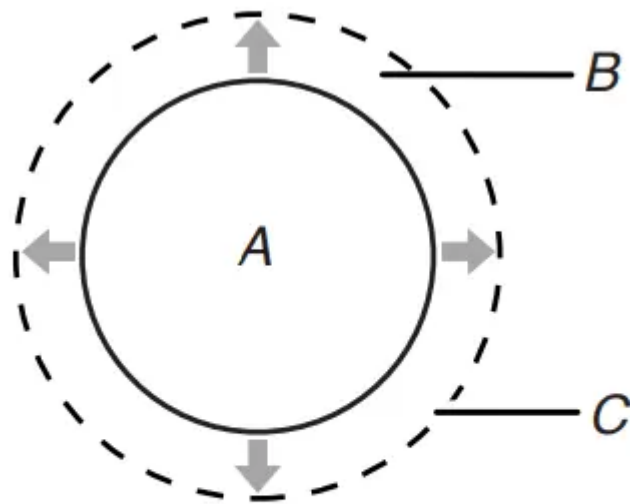

- A. Surface cooking area*
- B. Cookware/canner*
- C. 1/2" (1.3 cm) maximum overhang*

- Use flat-bottomed cookware for best heat conduction and energy efficiency. Cookware with rounded, warped, ribbed, or dented bottoms could cause uneven heating and poor cooking results.
- Determine flatness by placing the straight edge of a ruler across the bottom of the cookware. While you rotate the ruler, no space or light should be visible between it and the cookware.
- Cookware designed with slightly indented bottoms or small expansion channels can be used.
- Make sure the bottoms of pots and pans are clean and dry before using them. Residue and water can leave deposits when heated.
- To avoid damage to the cooktop, do not cook foods directly on the cooktop.

Ceramic Glass Cooktop Cleaning

Clean the cooktop after each use to help avoid scratches, pitting, abrasions, and to condition the glass surface. Ceramic glass cooktop cleaner and a cooktop scraper are also recommended for stubborn soils. Do not use abrasive cleaners, cleaning pads, or harsh chemicals for cleaning. The Cooktop Care Kit Part Number contains all of the items needed to clean and condition your ceramic glass cooktop. Refer to the "Range Care" section for additional information.

Cooktop On Indicator Light

The Cooktop On indicator light is located on the display panel.

When any cooktop element on the console panel is turned on, the Cooktop On indicator light will glow.

Hot Surface Indicator Light

On ceramic glass models, the Hot Surface indicator light is located on the display panel.

The Hot Surface indicator light will glow as long as any surface cooking area is too hot to touch, even after the surface cooking area is turned off.

Dual Zone Cooking Element (on some models)

The Dual Zone cooking element offers flexibility depending on the size of the cookware. Single size can be used in the same way as a regular element. The dual size combines both the single and outer elements and is recommended for larger size cookware.

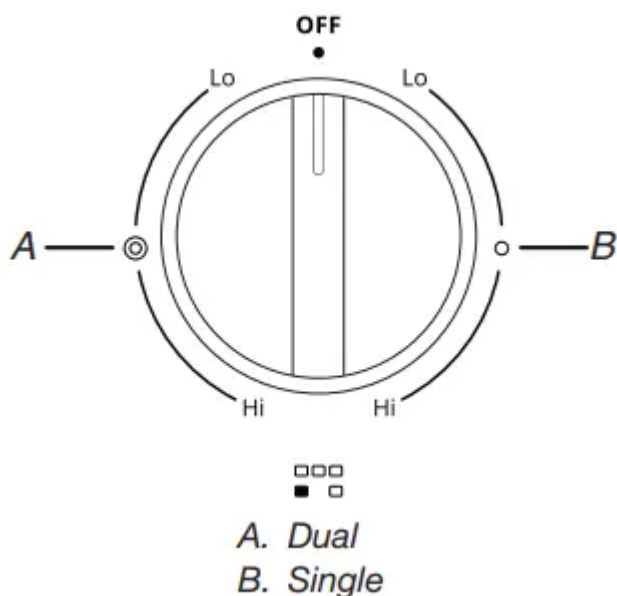

Melt Cooking Element (on some models)

The Melt cooking element offers flexibility due to a wide range of settings between HI and Melt. The HI heat option can be used to boil small amounts of liquid quickly. The lowest setting can be used to prepare sauces and to keep foods at a low temperature.

Use cookware appropriate in size for the Melt element.

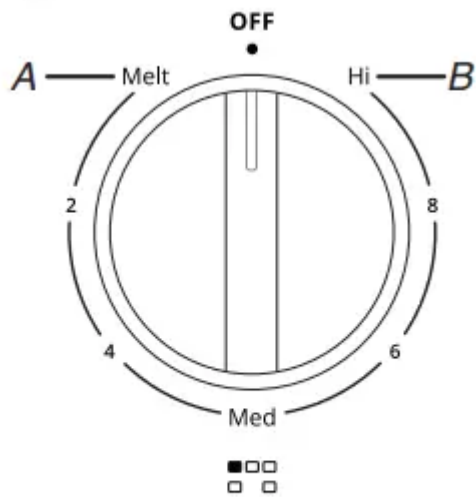

A. Melt option
 B. Hi heat option

Warm Zone

Use the cooktop Warm Zone to keep cooked foods warm. One hour is the recommended maximum time to maintain food quality.

Do not use it to heat cold foods.

The Warm Zone can be used alone or when any of the other surface cooking areas are being used.

The Warm Zone area will not glow red when cycling on. However, the Cooktop On indicator light will be displayed when the Warm Zone is in use.

- Use only cookware recommended for oven and cooktop use.
- Cover all foods with a lid or aluminum foil. When warming baked goods, allow a small opening in the cover for moisture to escape.
- To avoid damage to the cooktop, do not use plastic wrap to cover food because the plastic wrap may melt.
- Use pot holders or oven mitts to remove food.

To Use:

1. To turn on, press WARM ZONE and then the Start keypad.
2. To turn off, press WARM ZONE.

Cookware

IMPORTANT: Do not leave empty cookware on a hot surface cooking area, element, or surface burner.



Ideal cookware should have a flat bottom, straight sides, and a well-fitting lid, and the material should be of medium-to-heavy thickness.

Rough finishes may scratch the cooktop. Aluminum and copper may be used as a core or base in cookware. However, when used as a base, they can leave permanent marks on the surfaces.

Cookware material is a factor in how quickly and evenly heat is transferred which affects cooking results. A nonstick finish has the same characteristics as its base material. For example, aluminum cookware with a nonstick finish will take on the properties of aluminum.

Cookware with nonstick surfaces should not be used under the broiler.

Check for flatness by placing the straight edge of a ruler across the bottom of the cookware. While you rotate the ruler, no space or light should be visible between it and the cookware.

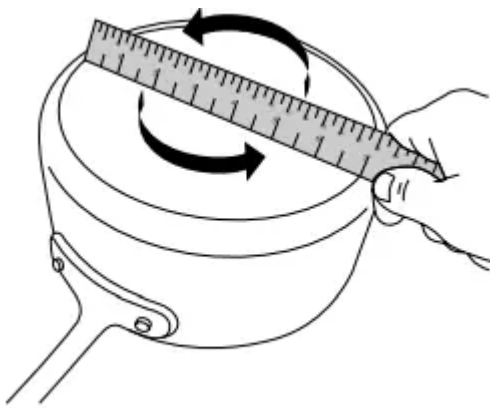

Use the following chart as a guide for cookware material characteristics

Cookware	Characteristics
Aluminum	<ul style="list-style-type: none"> • Heats quickly and evenly. • Suitable for all types of cooking • Medium or heavy thickness is best for most cooking tasks. • May leave aluminum residue which may be diminished if cleaned immediately after cooking.
Cast iron	<ul style="list-style-type: none"> • Heats slowly and evenly. • Good for browning and frying • Maintains heat for slow cooking. • Rough edges or burrs may scratch the cooktop.
Ceramic or ceramic glass	<ul style="list-style-type: none"> • Follow manufacturer's instructions. • Heats slowly, but unevenly. • Ideal results on low-to-medium heat settings • May scratch the cooktop.
Copper	<ul style="list-style-type: none"> • Heats very quickly and evenly. • May leave copper residue which may be diminished if cleaned immediately after cooking. • Can leave a permanent stain or bond to the cooktop if overheated.
Earthenware	<ul style="list-style-type: none"> • Follow manufacturer's instructions. • Use on low heat settings. • May scratch the cooktop.
Porcelain enamel -on-steel or cast iron	<ul style="list-style-type: none"> • See stainless steel or cast iron.

	<ul style="list-style-type: none"> • Porcelain enamel bakeware without the metal base may bond to the cooktop if overheated
Stainless steel	<ul style="list-style-type: none"> • Heats quickly, but unevenly. • A core or base of aluminum or copper on stainless steel provides even heating.

Use flat-bottomed cookware for best cooking results and energy efficiency. The cookware should be about the same size as the cooking area outlined on the cooktop. Cookware should not extend more than 1/2" (1.3 cm) outside the area.

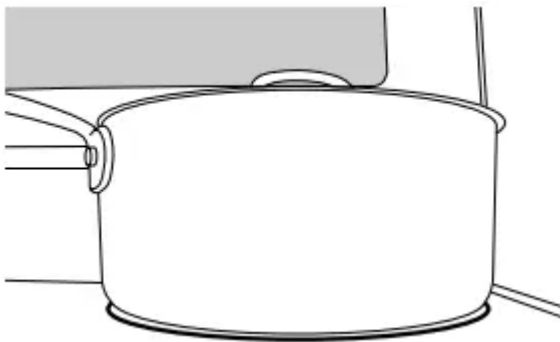

Home Canning

Canning can be performed on a glass smoothtop cooking surface or traditional coil element cooktop. When canning for long periods, alternate the use of surface cooking areas or elements between batches. This allows time for the most recently used areas to cool.

- Center the canner on the largest surface cooking area or element. On electric cooktops, canners should not extend more than 1/2" (1.3 cm) beyond the surface cooking area or element.
- Do not place canner on two surface cooking areas or elements at the same time.
- On ceramic glass models, use only flat-bottomed canners to avoid damage to the cooktop and elements.
- For more information, contact your local agricultural extension office or refer to published home canning guides. Companies that manufacture home canning products can also offer assistance

OVEN USE

Odors and smoke are normal when the oven is used the first few times or when it is heavily soiled.

IMPORTANT: The health of some birds is extremely sensitive to the fumes given off. Exposure to the fumes may result in death to certain birds. Always move birds to another closed and well-ventilated room.

Electronic Oven Controls

Control Display

The display will flash when powered up or after a power loss.

Press the Cancel keypad to clear. When oven is not in use, the time of day is displayed.

Fahrenheit and Celsius

The temperature is preset to Fahrenheit but can be changed to Celsius.

To change: Press and hold the Temp/Time up arrow keypad for seconds. “°C” or “°F” will appear on the display. Repeat to change back.

To exit mode, press the Cancel keypad.

Keypress Tones

Activates or turns off the tones when a keypad is pressed.

To change: Press and hold LIGHT for 5 seconds. Repeat to change back.

To exit mode, press the Cancel keypad.

Demo Mode

IMPORTANT: This feature is intended for use on the sales floor with 120 V power connection and permits the control features to be demonstrated without heating elements turning on. If this feature is activated, the oven will not work.

To change: Press the Cancel keypad, the Cancel keypad, the

Temp/Time up arrow keypad, TIMER SET/OFF. Repeat to change back and end Demo mode.

Tones

Tones are audible signals, indicating the following:

Basic Functions

One Tone

- Valid keypad press

- Oven is preheated (long tone).
- Function has been entered.
- Reminder, repeating every 20 seconds after the end-of-cycle tones

Three Tones

- Invalid keypad press

Four Tones

- End of cycle

Oven Temperature Control

IMPORTANT: Do not use a thermometer to measure oven temperature. Elements will cycle on and off as needed to provide consistent temperature but may run slightly hot or cool at any point in time due to this cycling. Most thermometers are slow to react to temperature change and will not provide an accurate reading due to this cycling.

The oven provides accurate temperatures; however, it may cook faster or slower than your previous oven, so the temperature can be adjusted to personalize it for your cooking needs. It can be changed in Fahrenheit or Celsius.

To Adjust Oven Temperature:

1. Press and hold the Temp/Time down arrow keypad for seconds until the oven display shows the current setting, for example "0°F CAL" or "00."
2. Press the Temp/Time up or down arrow keypad to increase or to decrease the temperature in 5°F (3°C) amounts. The adjustment can be set between 30°F (18°C) and -30°F (-18°C).
3. Press the Start keypad.

Sabbath Mode on some models)

For guidance on usage and a complete list of models with Sabbath mode, visit www.star-k.org.

The Sabbath mode sets the oven to remain on in a Bake setting until turned off. A Timed Bake can also be set to keep the oven on for only part of the Sabbath. The Oven Control Lockout feature will be disabled during the Sabbath mode. After the Sabbath mode is set, no tones will sound, the display will not show the temperature, the Kitchen Timer mode will be canceled (if active), and only the following keypads will function:

- Temp/Time up and down arrow keypads
- Cancel

When the oven door is opened or closed, the oven light will not turn on or off and the heating elements will not turn on or off.

When power is restored after a power failure, the oven will return to Sabbath mode and remain Sabbath compliant with the bake elements off until the Cancel keypad is pressed.

Pressing the Cancel keypad at any time returns the oven to the normal cooking mode (not Sabbath compliant).

Before entering the Sabbath mode, it must be decided if the oven light is to be on or off for the entire Sabbath mode period. If the light is on when entering Sabbath mode, it will remain on for the entire time Sabbath mode is in use. If the light is off when entering Sabbath mode, it will remain off for the entire time Sabbath mode is in use. Opening the oven door or pressing LIGHT will not affect the oven light once Sabbath mode has been entered.

On the Holiday, the oven temperature can be changed once the oven is in Sabbath mode by pressing the Temp/Time up or down arrow keypad. The oven temperature will change 25°F (14°C) each time the Temp/Time up and down arrow keypads are pressed. Press the Start keypad to activate the new temperature. The display will not change and there will be no sounds during this adjustment.

To Activate and Bake Using Sabbath Mode:

1. Press BAKE.
2. Press the Temp/Time up or down arrow keypad.
3. Press the Start keypad.
4. Press and hold TIMER SET/OFF for 5 seconds. "SAb" will flash in the display.
5. Press the Start keypad while "SAb" is flashing to enter Sabbath mode; otherwise, the entire cycle cancels out. "SAb" will stop flashing and remain on in the display. The oven is now in Sabbath mode and is Sabbath compliant.

Pressing the Cancel keypad at any time returns the oven to the normal cooking mode (not Sabbath compliant).

NOTE: If "SAb" does not appear in your display, the Sabbath mode is not active. After Sabbath mode is deactivated, you must activate Sabbath mode by completing steps 1 through 5.

To Set a Timed Bake Using Sabbath Mode on some models):

1. Press BAKE.
2. Press the Temp/Time up or down arrow keypad to enter a temperature other than the one displayed.
3. Press COOK TIME. The Cook Time oven indicator light will light up.
4. Press the Temp/Time up or down arrow keypad to enter a cook time length.
5. Press the Start keypad.
6. Press and hold TIMER SET/OFF for 5 seconds. "SAb" will flash in the display.

7. Press the Start keypad while "SAb" is flashing to enter Sabbath mode; otherwise, the entire cycle cancels out. "SAb" will stop flashing and remain on in the display. The oven is now in Sabbath mode and is Sabbath compliant. The Bake, On, and Cook Time indicator lights will be displayed.

When the set cook time ends, the oven will shut off automatically and the indicator lights will turn off, indicating the end of the cycle.

Pressing the Cancel keypad at any time returns the oven to the normal cooking mode (not Sabbath mode compliant).

NOTE: If "SAb" does not appear in your display, the Sabbath mode is not active. After Sabbath mode is deactivated, you must activate Sabbath mode by completing steps 1 through 5.

To Set a Delayed Timed Bake Using Sabbath Mode on some models):

1. Press BAKE.
2. Press the Temp/Time up or down arrow keypad to enter a temperature other than the one displayed.
3. Press COOK TIME. The Cook Time oven indicator light will light up.
4. Press the Temp/Time up or down arrow keypad to enter a cook time length.
5. Press DELAY START. The Delay indicator light will light up.
6. Press the Temp/Time up or down arrow keypad to enter a start time.
7. Press the Start keypad.
8. Press and hold TIMER SET/OFF for 5 seconds. "SAb" will flash in the display.
9. Press the Start keypad while "SAb" is flashing to enter Sabbath mode; otherwise, the entire cycle cancels out. "SAb" will stop flashing and remain on in the display. The oven is now in Sabbath mode and is Sabbath compliant. The On and Delay indicator lights will be displayed.

When the start time is reached, the Bake, On, and Cook Time indicator lights will automatically turn on. When the set cook time ends, the oven will shut off automatically and the indicator lights will turn off, indicating the end of the cycle.

Pressing the Cancel keypad at any time returns the oven to the normal cooking mode (not Sabbath mode compliant).

NOTE: If "SAb" does not appear in your display, the Sabbath mode is not active. After Sabbath mode is deactivated, you must activate Sabbath mode by completing steps 1 through 5.

Keep Warm

IMPORTANT: Food must be at serving temperature before placing it in the warmed oven. Food may be held up to 1 hour; however, breads and casseroles may become too dry if left in the oven during the Keep Warm function. For best results, cover food.

The Keep Warm feature allows hot cooked foods to stay at serving temperature.

To Use:

1. Press KEEP WARM.
2. Press the Temp/Time up or down arrow keypad until desired temperature is reached. A tone will sound if the minimum or maximum temperature is reached.
3. Press the Start keypad.
4. Place food in the oven.
5. Press the Cancel keypad when finished.

NOTE: The temperature may be changed at any time by pressing the Temp/Time up or down arrow keypad to reach the desired temperature and then pressing the Start keypad.

Aluminum Foil

IMPORTANT: To avoid permanent damage to the oven bottom finish, do not line the oven bottom with any type of foil or liner.

For best cooking results, do not cover entire oven rack with foil because air must be able to move freely.

Positioning Racks and Bakeware

IMPORTANT: To avoid permanent damage to the porcelain finish, do not place food or bakeware directly on the oven door or bottom.

Bakeware

To cook food evenly, hot air must be able to circulate. Allow 2"(5cm) of space around bakeware and oven walls. Make sure that no bakeware piece is directly over another.

Racks

- Position racks before turning on the oven.
- Do not position racks with bakeware on them.
- Make sure racks are level.

To move a rack, pull it out to the stop position, raise the front edge, and then lift out. Use the following illustration as a guide.

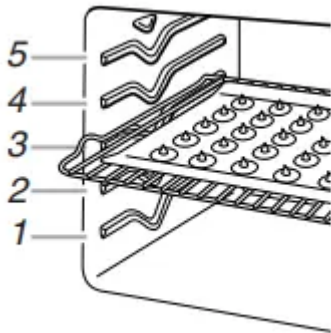

The oven has seven positions for a flat rack, as shown in the previous illustration and the following table.

Flat Rack Position	Type of Food
5	Broiling/searing meats, hamburgers, steaks, or toast.
4	Broiling thicker cuts of meat, poultry, fish
3 or 4	Frozen prepackaged foods, most baked goods, and casseroles.
1 or 2	Large roasts or poultry

Multiple Rack Cooking

Two-rack: Use rack positions 2 and 4 or 2 and 5

Baking Cookies and Layer Cakes on Two Racks

Baking Layer Cakes

For best results when baking cakes on two racks, use the Bake function, a flat rack in rack position 4, and a flat rack in rack position 2. Place the cakes on the racks as shown. Keep at least 3"(7.6 cm) of space between the front of the racks and the front cakes.

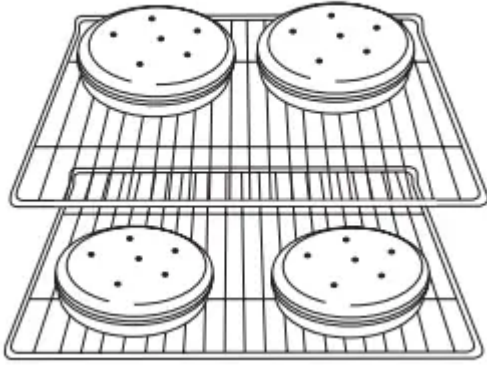

Baking Cookies on Two Racks

For best results when baking cookies on two racks, use the Bake function and place flat racks in positions 2 and 5.

Oven Vent

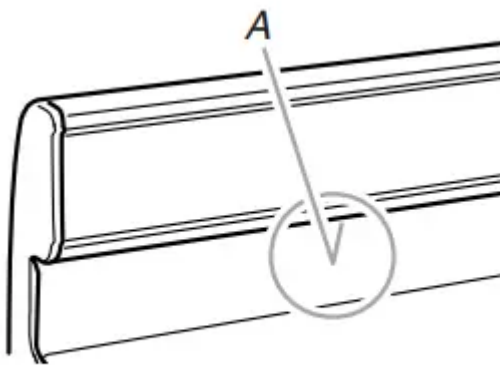

A. Oven vent

The oven vent releases hot air and moisture from the oven and should not be blocked or covered. Blocking or covering the oven vent will cause poor air circulation, affecting cooking and cleaning results. Do not set plastics, paper, or other items that could melt or burn near the oven vent.

Baking and Roasting

Preheating

When beginning a Bake cycle, the oven will begin preheating after Start is pressed. The oven will take approximately 12 to 15 minutes to reach 350°F (177°C) with all of the oven racks provided with your oven inside the oven cavity. Higher temperatures will take longer to preheat. The preheat cycle rapidly increases the oven temperature. The actual oven temperature will go above your set temperature to offset the heat lost when your oven door is opened to insert food. This ensures that

when you place your food in the oven, the oven will begin at the proper temperature. Insert your food when the preheat tone sounds. Do not open the door during preheat before the tone sounds.

Oven Temperature

While in use, the oven elements will cycle on and off as needed to maintain a consistent temperature, but they may run slightly hot or cool at any point in time due to this cycling. Opening the oven door while in use will release the hot air and cool the oven which could impact the cooking time and performance. It is recommended to use the oven light to monitor cooking progress.

Temperature Management System

The Temperature Management System electronically regulates the oven heat levels during preheat and bake to maintain a precise temperature range for optimal cooking results. The bake and broil elements or burners cycle on and off in intervals. On convection range models, the fan will run while preheating and may be cycled on and off for short intervals during bake to provide the best results. This feature is automatically activated when the oven is in use.

Before baking and roasting, position racks according to the Positioning Racks and Bakeware” section. When roasting, it is not necessary to wait for the oven preheat cycle to end before putting food in unless it is recommended in the recipe.

Broiling

When broiling, preheat the oven for two minutes before putting food in unless recommended otherwise in the recipe. Position food on grid in a broiler pan, then place it in the center of the oven rack.

IMPORTANT: Close the door to ensure proper broiling temperature.

Changing the temperature when broiling allows more precise control when cooking. The lower the broil setting is, the slower the cooking. Thicker cuts and unevenly shaped pieces of meat, fish, and poultry may cook better at lower broil settings. Use racks 4 or 5 for broiling. Refer to the “Positioning Racks and Bakeware” section for more information.

On lower settings, the broil element will cycle on and off to maintain the proper temperature.

- For best results, use a broiler pan and grid. It is designed to drain juices and help avoid spatter and smoke. If you would like to purchase a broiler pan, one may be ordered. Please refer to the “Accessories” section for more information.

NOTE: Odors and smoke are normal the first few times the oven is used or if the oven is heavily soiled.

Cook Time

To Set a Timed Cook:

1. Press BAKE. The Bake indicator light will light up.
2. Press the Temp/Time up or down arrow keypad to enter a temperature other than the one displayed.
3. Press COOK TIME. The cook time oven indicator light will light up.
4. Press the Temp/Time up or down arrow keypad to enter the length of time to cook.
5. Press the Start keypad. The display will count down the time. When the time ends, the oven will shut off automatically.
6. Press the Cancel keypad to clear the display.

To Set a Delayed Timed Cook:

Before setting, make sure the clock is set to the correct time of day. See the “Clock” keypad feature in the “Feature Guide” section.

1. Press BAKE.
2. Press the Temp/Time up or down arrow keypad to enter a temperature other than the one displayed.
3. Press COOK TIME. The cook time oven indicator light will light up.
4. Press the Temp/Time up or down arrow keypad to enter the length of time to cook.
5. Press DELAY START. The delay oven indicator light will light up.
6. Press the Temp/Time up or down arrow keypad to enter the amount of time until desired start.
7. Press the Start keypad. When the start time is reached, the oven will automatically turn on. The temperature and/or time settings can be changed anytime after pressing the Start keypad by repeating steps 1 through 7. When the set cook time ends, the oven will shut off automatically.
8. Press the Cancel keypad to clear the display.

RANGE CARE

Steam Clean

IMPORTANT: Do not use oven cleaners or any other additives with Steam Clean.

The Steam Clean feature is designed for light oven cavity bottom cleaning and is not intended to clean heavy or difficult soils. Use the Steam Clean feature as soon as possible after spills occur. The longer a spill sits and dries in the oven, the more difficult it may be to remove.

Allow the range to cool to room temperature before using the Steam Clean feature. If your oven cavity is above 170°F (77°C), "HOT" will appear in the display and the Steam Clean feature will not activate until it cools down.

- Remove all racks and accessories from the oven cavity.
- For best results, pour 12 oz (355 mL) of distilled or filtered water onto the oven bottom.
- The Steam Clean feature will take a total of 50 minutes. "End" will appear in the display at the end of the cycle.

IMPORTANT: Since the water in the oven bottom is hot, do not open the oven door during the Steam Clean cycle.

Press the Cancel keypad at any time to end the cycle. The display will return to the time of day.

Helpful Hints

- Once the Steam Clean cycle is complete, remove all remaining water and debris in the bottom of the oven with a sponge or cloth.
- Wipe any remaining moisture from the oven door interior, oven cavity interior sides, and cooktop.
- Use a soft brush or nylon scrubber to wipe the oven interior. This may help with more stubborn stains.
- If any soil remains, run a second Steam Clean cycle to help loosen debris for easier removal.
- Use the Steam Clean on small spills such as cheese or sauce from pizza or snacks, or drips from casseroles.
- Food spills containing sugar, proteins, or starches may require vigorous scrubbing to remove most of the debris.
- It is recommended to use distilled or filtered water, as tap water may leave mineral deposits on the oven bottom. Use a cloth soaked with vinegar or lemon juice to remove any mineral deposits that may be left after the Steam Clean cycle.

General Cleaning

Soap, water, and a soft cloth or sponge are suggested first unless otherwise noted.

EXTERIOR PORCELAIN ENAMEL SURFACES (on some models)

Food spills containing acids, such as vinegar and tomato, should be cleaned as soon as the entire range is cool. These spills may affect the finish.

Cleaning Method:

- Glass cleaner, mild liquid cleaner, or nonabrasive scrubbing pad: Gently clean around the model/serial/rating plate because scrubbing may remove numbers.
- Affresh® Kitchen and Appliance Cleaner Part Number W10355010 (not included): See the “Accessories” section for more information.

STAINLESS STEEL (on some models)**Cleaning Method:**

Rub in direction of grain to avoid damaging.

- Affresh® Stainless Steel Cleaner Part Number W10355016 not included): See the “Accessories” section for more information.

METALLIC PAINT (on some models)

Do not use abrasive cleaners, cleaners with bleach, rust removers, ammonia, or sodium hydroxide (lye) because the paint surface may stain.

CERAMIC GLASS**Cleaning Method:**

To avoid damaging the cooktop, do not use steel wool, abrasive powder cleansers, chlorine bleach, rust remover, or ammonia.

1. Remove food/residue with the Cooktop Scraper.

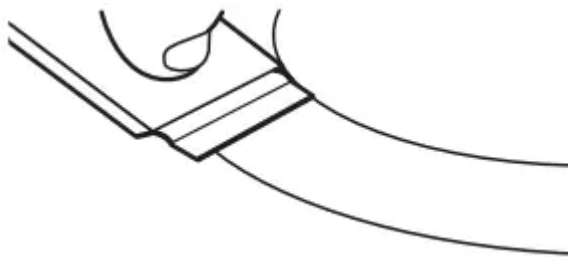

- For best results, use the Cooktop Scraper while the cooktop is still warm but not hot to the touch. It is recommended to wear an oven mitt while scraping the warm cooktop.
- Hold the Cooktop Scraper at approximately a 45° angle against the glass surface and scrape the residue. It will be necessary to apply pressure in order to remove the residue.

Allow the cooktop to cool down completely before proceeding to Step 2.

2. Apply a few dime-sized drops of affresh® Cooktop Cleaner to the affected areas.

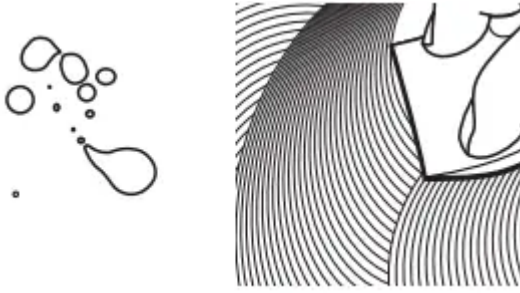

- Rub affresh® Cooktop Cleaner onto the cooktop surface with the blue Cooktop Cleaning Pad. Some pressure is needed to remove stubborn stains.
- Allow the cleaner to dry to a white haze before proceeding to Step 3.

3. Polish with a clean, dry cloth or a clean, dry paper towel.



- Repeat steps 1 through 3 as necessary for stubborn or burned-on stains.

The Complete Cooktop Cleaner Kit is available for order and includes the following:

- Cooktop Scraper
- Affresh® Cooktop Cleaner
- Blue Cooktop Cleaning Pads

See the “Accessories” section for part numbers and information on ordering.

COOKTOP CONTROLS

To avoid damage to the cooktop controls, do not use steel wool, abrasive cleansers, or oven cleaner.

To avoid damage, do not soak knobs.

When replacing knobs, make sure knobs are in the Off position.

On some models, do not remove seals under knobs.

Cleaning Method:

- Soap and water: Pull knobs straight away from control panel to remove.

CONTROL PANEL AND OVEN DOOR EXTERIOR

To avoid damage to the control panel, do not use abrasive cleaners, steel-wool pads, gritty washcloths, or abrasive paper towels.

Cleaning Method:

- Glass cleaner and soft cloth or sponge: Apply glass cleaner to soft cloth or sponge, not directly on panel.
- Affresh® Kitchen and Appliance Cleaner Part Number W10355010 (not included): See the “Accessories” section for more information.

OVEN RACKS

Cleaning Method:

- Steel-wool pad
- For racks that have discolored and are harder to slide, a light coating of vegetable oil applied to the rack guides will help them slide.

STORAGE DRAWER (on some models)

Check that storage drawer is cool and empty before cleaning.

Cleaning Method:

- Mild detergent

OVEN CAVITY

Food spills should be cleaned when oven cools. At high temperatures, foods react with porcelain. Staining, etching, pitting, or faint white spots can result.

Nonabrasive plastic scrubbing pad and mildly abrasive cleanser can be used on a cool cavity.

If using commercial oven cleaners, follow package directions.

Oven Light

The oven light is a standard 40 W appliance bulb. Before replacing, make sure the oven and cooktop are cool and the control knobs are in the Off position.

To Replace:

1. Unplug range or disconnect power.
2. Turn the glass bulb cover in the back of the oven counterclockwise to remove.
3. Turn bulb counterclockwise to remove from socket.

4. Replace bulb, then bulb cover by turning clockwise.
5. Plug in range or reconnect power.

TROUBLESHOOTING

Operation



Problem	Possible Causes	Solutions
Nothing will operate	Power supply cord is unplugged.	Plug into a grounded outlet
	Household fuse is blown or a circuit breaker is tripped	Replace the fuse or reset the circuit breaker. If the problem continues, call an electrician.
	The control displays an F9 or F9 E0 error code.	The electrical outlet in the home may be miswired. Contact a qualified electrician to verify the electrical supply.
Cooktop will not operate	The control knob is set incorrectly	Push in knob before turning to a setting
	On ceramic glass models, the oven control lockout is set.	See the "Control Lock" keypad feature in the "Feature Guide" section.
Excessive heat around cookware on cooktop	Cookware that is not the proper size	Use cookware about the same size as the surface cooking area, element, or surface burner. Cookware should not extend more than 1/2" (1.3 cm) outside the cooking area.
Cooktop cooking results not what expected	Control knob set to incorrect heat level.	See the "Cooktop Use" section
	Range is not level.	Level the range. See the Installation Instructions.
Cooktop element cycles on and off on High setting	Element cycling due to a temperature limiter.	This is normal operation. The element may cycle on and off to keep the cooktop from overheating.
Oven will not operate	Delay Start is set.	See the "Electronic Oven Controls" section.
	Control lock is on.	Press and hold CONTROL LOCK for 3 seconds to unlock.

	Control is in Demo mode	Demo mode will deactivate all oven elements. See “Demo Mode” in the “Electronic Oven Controls” section
	Electronic oven control set incorrectly.	See the “Electronic Oven Controls” section.
Oven temperature too high or too low	Oven temperature needs adjustment.	See “Oven Temperature Control” in the “Electronic Oven Controls” section
Oven indicator lights flash	Power to range is turned on or restored.	See “Control Display” in the “Electronic Oven Controls” section. If the indicator light(s) keep(s) flashing, call for service. See the “Warranty” section for contact information.
Display shows messages	Power failure (display shows flashing time).	Clear the display. On some models, reset the clock, if needed. See the “Clock” keypad feature in the “Feature Guide” section
	Error code (display shows letter followed by number).	Depending on your model, press the Cancel keypad to clear the display. See “Control Display” in the “Electronic Oven Controls” section. If it reappears, call for service. See the “Warranty” section for contact information
	The Start keypad needs to be pressed so a cycle can begin.	See the “Start” keypad feature in the “Feature Guide” section.
Steam Clean cycle will not operate	The Steam Clean function has not been entered correctly.	See the “Steam Clean” section.
	A Timed Cook function has been entered.	See the “Cook Time” section
	The range is in Sabbath mode	See the “Sabbath Mode” section.

Oven cooking results not what expected	Range is not level.	Level the range. See the Installation Instructions
	The temperature set was incorrect	Double-check the recipe in a reliable cookbook
	Oven temperature is calibrated incorrectly.	See "Oven Temperature Control" in the "Electronic Oven Controls" section.
	Oven was not preheated	See the "Baking and Roasting" section.
	Racks were positioned improperly	See the "Positioning Racks and Bakeware" section.
	Not enough air circulation around bakeware.	See the "Positioning Racks and Bakeware" section
	Batter distributed unevenly in pan.	Check that batter is level in the pan
	Darker browning of food caused by dull or dark bakeware.	Lower oven temperature 25°F (15°C) or move rack to a higher position in the oven.
	Lighter browning of food caused by shiny or light-colored bakeware	Move rack to a lower position in the oven.
	Incorrect length of cooking time was used.	Adjust cooking time
	Oven door was not closed.	Be sure that the bakeware does not keep the door from closing.
	Oven door was opened during cooking.	Oven peeking releases oven heat and can result in longer cooking times.
	Rack is too close to bake burner, making baked items too brown on bottom.	Move rack to higher position in the oven
	Pie crusts browning too quickly	Use aluminum foil to cover the edge of the crust and/or reduce baking temperature.

Temperature scale was changed from Fahrenheit to Celsius.	Foods are overdone or burnt, even at low temperatures. See “Fahrenheit and Celsius” in the “Electronic Oven Controls” section
---	---

Warning

This content is compiled from multiple sources and is provided for reference purposes only. It may not be complete or fully applicable to all situations. If you are unable to resolve your issue, please contact the product manufacturer or an authorized service provider for official support.

