

PRODUCT OVERVIEW

Product Features

The images in this guide may be different from the actual components and accessories, which are subject to change by the manufacturer without prior notice for product improvement purposes.

Front View

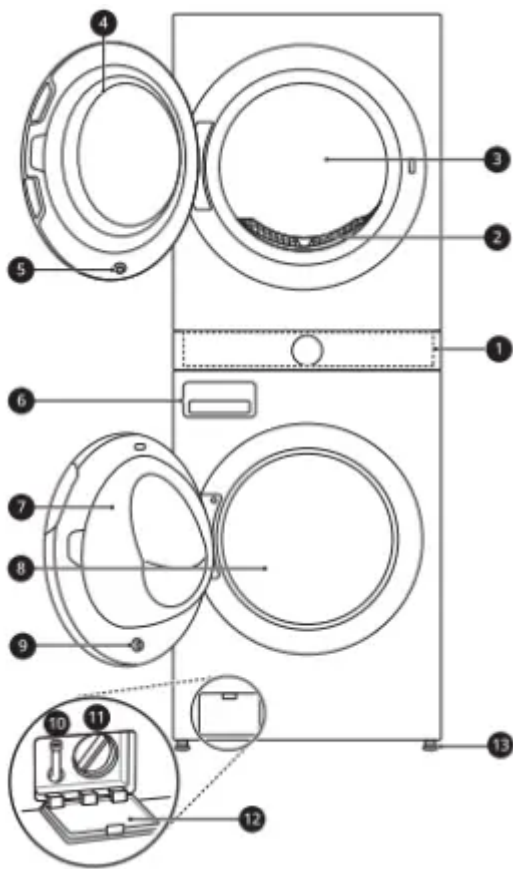

1. Control Panel
2. Lint Filter
3. Dryer Drum
4. Dryer Door
5. Dryer Door Magnet
6. Detergent Dispenser Drawer
7. Washer Door
8. Washer Drum
9. Washer Door Magnet

- 10. Drain Hose
- 11. Drain Pump Filter
- 12. Drain Pump Filter Cover
- 13. Leveling Feet

Rear View

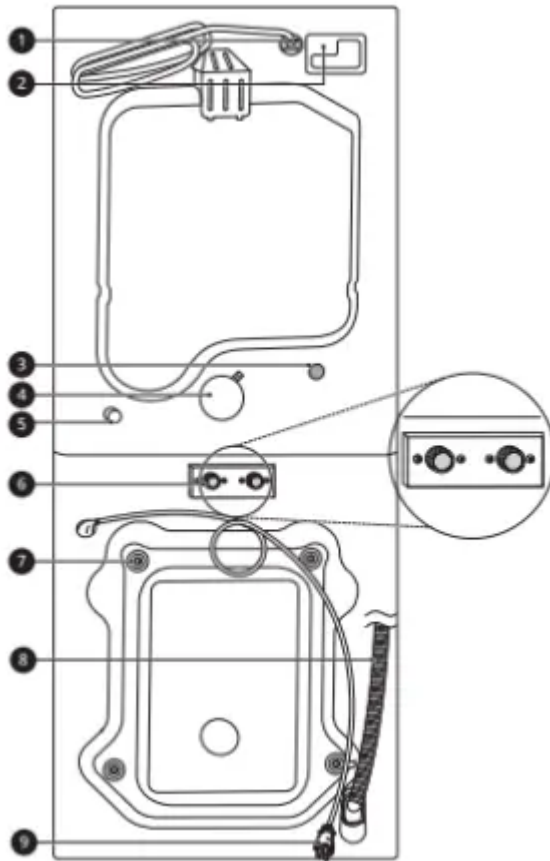

- 1. Power Cord (for Gas Models)
- 2. Terminal Block Access Panel (for Electric Models)
- 3. Cold Water Inlet
- 4. Exhaust Duct Outlet
- 5. Gas connection (for Gas Models)
- 6. Hot and Cold Water Inlets
- 7. Shipping Bolts
- 8. Drain Hose
- 9. Power Cord (for Washer)

Product Specifications



Model	WKEX200H*A / WKGX201H*A
Electrical Requirements	Please refer to the rating label for detailed information.
Min. / Max. Water Pressure	20 - 120 psi (138 - 827 kPa)
Dimensions (Width X Height X Depth)	27" X 74 3/8" X 30 3/8" (70 cm X 189 cm X 77 cm)
Maximum Depth with Door Open	55" (139.6 cm)
Net Weight	320 lb (145 kg)
Capacity (Washer/Dryer)	4.5 cu.ft. / 7.4 cu.ft.
Max. Spin Speed (Washer)	1300 RPM
Gas Requirements	NG: 4 - 10.5-inch (10.2 - 26.7 cm) WC LP: 8 - 13-inch (20.4 - 33.1 cm) WC
Operating Temperature Range	41-95 °F (5-35 °C)



Accessories

Included Accessories

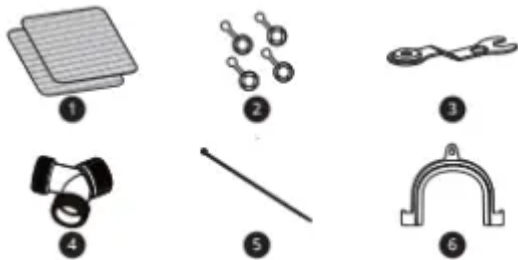

1. Non-skid Pads
2. Hole Caps
3. Wrench
4. Y Connector
5. Tie Strap
6. Elbow Bracket (for securing drain hose)

Required Accessories



1. Hot and Cold Water Hoses (for Washer)

2. Cold Water Hose (for Dryer)
3. Connecting Supply Hose
4. Tie Straps

Optional Accessories

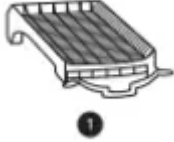

1. Drying Rack

NOTE

- Depending on the model, the rack may be an included accessory.

WARNING

- For your safety and for extended product life, use only authorized components. The manufacturer is not responsible for product malfunction, property damage or bodily injury caused by the use of separately purchased unauthorized components, parts, or non-LG products.

OPERATION-WASHER

Using the Washer

Operation Overview

1 Sort laundry and load the washer.

- Sort laundry by fabric type, soil level, color and load size as needed. Open the door and load items into the washer.
- If using single-use detergent packs, place pack into the drum before loading the laundry.

2 Add cleaning products.

- Add the proper amount of HE (High Efficiency) detergent to the detergent dispenser.
- If desired, add bleach or fabric softener to the appropriate areas of the dispenser drawer.
- Do not place liquid or powdered detergent packs in the dispenser.

3 Turn on the washer.

- Press the Power button to turn on the washer.

4 Select a cycle.

- Turn the cycle selector knob or press the cycle buttons repeatedly until the desired cycle is selected.

- The preset wash temperature, spin speed, soil level and option settings for the selected cycle are shown.
- The Normal cycle must be selected in order to change its default settings.
- Pressing the Start/Pause button without selecting a cycle immediately starts the Normal cycle with the default settings.

5 Adjust settings.

- Default settings for the selected cycle can be changed, if desired, using the cycle modifier and option buttons.
- Not all modifiers and options are available on all cycles. A different chime sounds and the LED does not light up if the selection is not allowed.

6 Begin cycle.

- Press the Start/Pause button to begin the cycle. The door locks, and the washer agitates briefly without water to measure the weight of the load.
- If the Start/Pause button is not pressed within a certain time, the washer shuts off and all settings are lost.

6 End of cycle.

- When the cycle is finished, a melody sounds. Immediately remove the clothing from the washer to reduce wrinkling.
- Check around the door seal when removing the load for small items that may be caught in the seal.

Sorting Laundry

CAUTION

- Clothing or articles that are waterproof or water-resistant must be washed in the Waterproof, Bedding, Bulky/Large, or Jumbo Wash cycle only. (Examples include water resistant clothing, mattress covers, outdoor clothes, and plastic mats.) Failure to do so may result in personal injury or damage to the washer, clothes, walls, floor, and surrounding objects due to abnormal vibration.
- Remove the stuffing from pillows and cushions before washing the covers. Failure to do so can cause excessive vibration, resulting in damage to the washer, clothes, nearby objects, walls, and floor.

Grouping Similar Items

For the best washing results, and to reduce the possibility of damage to clothing, sort clothing into loads made up of similar items.

Mixing different fabric types and/or soil levels can result in poor wash performance, color transfer, discoloration, fabric damage or linting. Fabrics should be sorted into groups as described below.

Colors

Sort articles by color. Wash dark clothes separately from light colors or whites. Mixing dark clothes with light clothes can result in dye transfer or discoloration of the lighter clothes.

Soil Level

Wash heavily soiled clothing together. Washing lightly soiled clothing in the same load with heavily soiled clothing could result in poor wash performance for the lightly soiled clothing.

Fabric Type

Delicate articles should not be mixed with heavy or sturdy fabric types. Washing heavy fabrics with delicates can result in poor wash performance for the heavy fabrics and possible damage to the delicates.

Lint Type

Some fabrics attract and bind lint to them while others give off lint in the laundry process. Avoid mixing these lint collectors and lint producers in the same load. Mixing these fabrics will result in pilling and linting on the lint collectors. (For example, lint collector - knit sweater; lint producer - terry cloth towels.)











How to Sort Laundry

By Colors	By Soil	By Fabric	By Lint
White	Heavy	Delicates	Lint Producer
Lights	Normal	Easy Care	Lint Collector
Darks	Light	Sturdy	

Fabric Care Labels

Many articles of clothing include a fabric care label. Using the chart below, adjust the cycle and option selections to care for your clothing according to the manufacturer's recommendations.



Category	Label	Directions
 Washing		Hand wash
		Machine wash, Normal cycle
		Perm Press/Wrinkle Resistant setting (which has a cool down or cold spray before the slower spin)
		Gentle/Delicate setting (slow agitation and/or reduced wash time)
		Do not wash
		Do not wring
Water Temperature	***	Hot
	**	Warm
	·	Cold/Cool
 Bleach Symbols		Any bleach (when needed)
		Only non-chlorine bleach (when needed)
		Do not bleach

Loading the Washer

General Tips

- Check and empty pockets. Paper clips, coins, matches, etc. can damage clothing and the washer.
- Close zippers and hooks, and tie drawstrings to prevent snagging or tangling of clothes.
- Pretreat heavily stained areas for best results.
- Brush off heavy soil, dust, and hair from items before washing. Excess dirt or sand can abrade other fabrics and lead to poor wash performance.
- For best performance, load clothes as shown.

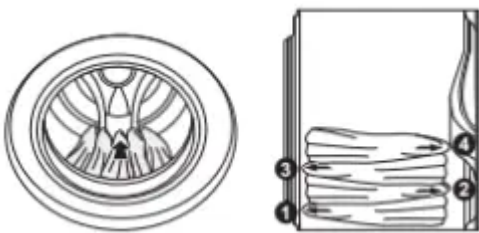

- Do not press down on items while stacking them in the drum.
- Load clothes loosely, and do not overfill the drum. Clothes need room to circulate in order to get clean.
- Combine large and small items in the drum. Load large items first. Large items should not be more than half of the total load.
- The washer can be fully loaded, but the drum should not be tightly packed with items. The door of the washer must close easily.
- The washer will not fill or operate with the door open.

Bulky Items

- Wash thick, bulky it load if combined with other items.

Small Items

- Do not wash a single small item. Add enough similar items to the load to prevent an out-of balance load.
- Wash small, light items in a mesh bag. Small items can get caught in the impeller at the bottom of the drum, and brassiere hooks can snag on other clothing or the drum.

Adding Cleaning Products

About Detergent Use

This washer is designed for use with only HE (High Efficiency) detergents.



- HE detergents produce fewer suds, dissolve more efficiently to improve washing and rinsing performance, and help to keep the interior of the washer clean. Using detergent that is not HE may cause oversudsing and unsatisfactory performance which could result in error codes, cycle failure, and washer damage.
- Detergents designated as HE-compatible may not provide optimal results.
- For proper wash performance, always measure detergent using the measuring device provided by the detergent manufacturer. For an average load, use less than half of the recommended maximum. Use less detergent for soft water, light soil, or smaller loads.
- Use extra care when measuring 2X and 3X concentrated detergents because even a small amount of extra detergent can lead to problems.
- Never use more than the maximum amount of detergent recommended by the manufacturer. Using too much detergent can lead to oversudsing, poor rinsing, detergent buildup in clothing, and residue buildup that can contribute to odors in the washer.

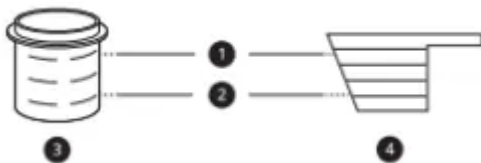

1. Maximum fill line
2. Average load fill line
3. Liquid detergent
4. Powdered detergent

Single-Use Detergent Packs

- Do not use more than one single-use detergent pack in the washer. Using too much detergent may cause oversudsing and unsatisfactory performance. Reduce detergent amount or add an extra rinse if detergent residue is left on fabrics. To add an extra rinse, select the Extra Rinse option.
- Place liquid or powdered detergent packs in the drum before loading laundry. Do not place detergent packs in the dispenser.

Using the Dispenser

To add cleaning products to the automatic dispenser:

- 1 Open the dispenser drawer.
- 2 Load the laundry products into the appropriate compartments.
 - Follow the manufacturer's recommendations when adding cleaning products.

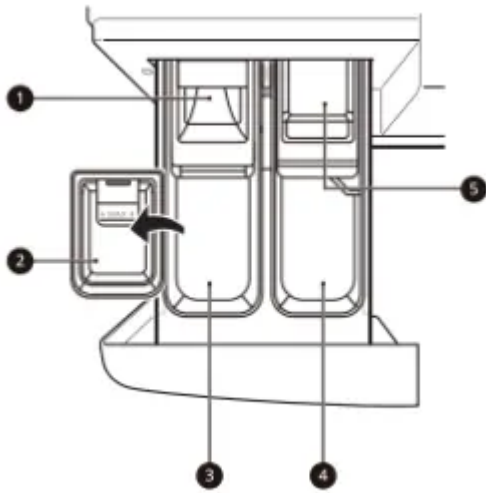

1. Pre-wash detergent compartment (on some models)
2. Liquid detergent cup
3. Main wash detergent compartment
4. Liquid fabric softener compartment
5. Liquid chlorine bleach compartment

3 Gently close the detergent dispenser drawer before starting the cycle.

- Slamming the drawer closed may result in the detergent overflowing into another compartment or dispensing into the drum earlier than programmed.
- Be careful not to get a hand caught in the drawer while closing.
- It is normal for a small amount of water to remain in the dispenser compartments at the end of the cycle.

CAUTION

- Do not place or store laundry products, such as detergent, bleach, or liquid fabric softener, on top of your washer. These products can damage the washer's finish and controls.

Pre-wash Detergent Compartment

Add liquid or powdered detergent to this compartment when using the Pre-wash option. Always use HE (High-Efficiency) detergent with your washer.

- When using the Pre-wash option, liquid detergent for the main wash needs to be loaded in the liquid detergent cup accessory in the main wash dispenser (where applicable), to prevent it from being dispensed with the pre-wash detergent.
- The amount of detergent added for the Pre wash option is 1/2 the amount recommended for the main wash cycle. For example, if the main wash cycle requires one measure of detergent, add 1/2 measure for the Pre-wash option.

Main Wash Detergent Compartment

This compartment holds laundry detergent for the main wash cycle. Either powdered or liquid detergent may be used in this compartment.

- The detergent is added to the load at the beginning of the cycle. Always use HE (High Efficiency) detergent with your washer.
- Do not exceed the maximum fill line. Using too much detergent can result in detergent buildup in clothing and the washer.
- Liquid or powdered color-safe bleach may be added to the main wash compartment with detergent of the same type. Do not mix liquids and powders
- If the dispenser has a liquid detergent cup and insert:
- Make sure they are in place when using liquid detergent.
 - Make sure to remove them when using powdered detergent. Powdered detergent will not dispense with the liquid detergent cup and insert in place.
- If you use a detergent that does not dissolve easily or a detergent with high viscosity, it will leave a residue and clog the dispenser.

Liquid Bleach Compartment

This compartment holds liquid bleach, which is dispensed automatically at the proper time during the wash cycle. The dispenser is activated twice to ensure complete dispensing of the bleach. Any liquid remaining in the dispenser at the end of the cycle is water, not bleach.

WARNING

- Do not mix chlorine bleach with ammonia or acids such as vinegar or rust/scale remover. Mixing chemicals like these can produce a lethal gas, resulting in severe injury or death.

NOTE

- Do not add powdered bleach to this compartment. The bleach compartment is designed to dispense liquid chlorine bleach only.
- Powdered or liquid color-safe bleach will not dispense properly.
- Follow the manufacturer's recommendations when adding bleach. Never add more than one cup, and do not exceed the maximum fill line or the bleach may be dispensed immediately and damage fabrics. Using too much bleach can also damage fabrics.
- Never pour undiluted liquid chlorine bleach directly onto the load or into the drum. Fabric damage can occur.
- Do not use color-safe bleach or oxygen bleach in the same cycle with liquid chlorine bleach.

Fabric Softener Compartment

This compartment holds fabric softener, which is automatically dispensed during the final rinse cycle. Either powdered or liquid fabric softener may be used.

- Do not exceed the maximum fill line. Using too much fabric softener may stain clothes or cause buildup on fabrics or in the washer.
- Dilute concentrated fabric softeners with warm water.
- Never pour fabric softener directly onto the load or into the drum.

Control Panel

Control Panel Features for the Washer

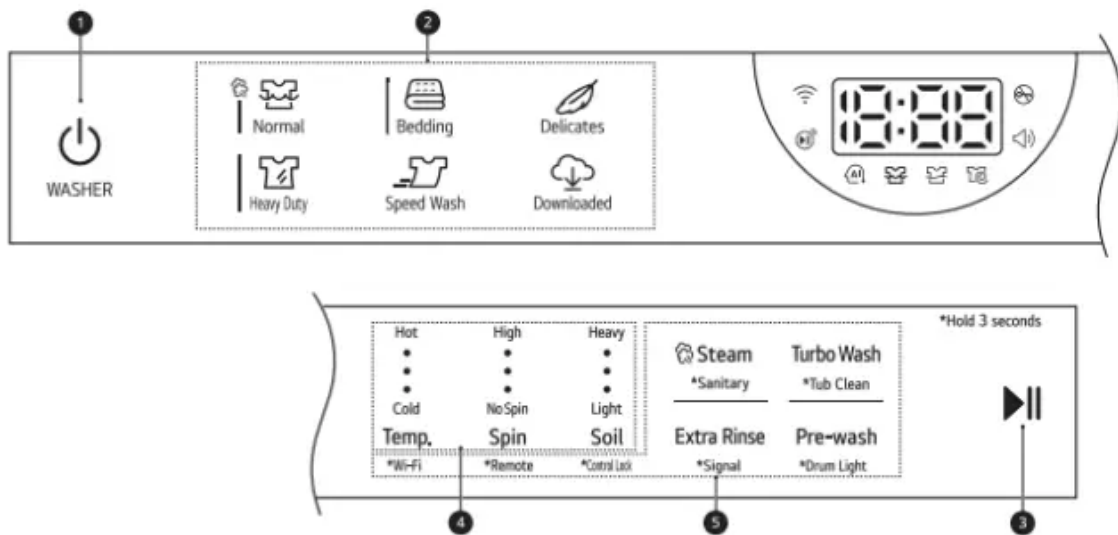

1 Power On/Off Button

- Press this button to turn the washer on or off.
- Pressing this button during a cycle will cancel that cycle and any load settings will be lost.
- The door will unlock after a brief pause.

NOTE

- If there is any water remaining in the drum after the washer shuts off, it will drain after a delay. The washer can be restarted at any time before the drain begins. However, once the water begins to drain, all functions will be suspended until the water has been completely drained and the washer shuts off.

2 Cycles

- Press a button to select the desired cycle.
- Once the desired cycle has been selected, the standard presets will appear in the display. These settings can be adjusted using the Cycle Modifier buttons at any time before starting the cycle.

3 Start/Pause Button

- Press and hold this button to start the selected cycle.
- If the washer is running, use this button to pause the cycle without losing the current settings.

NOTE

- If the Start/Pause button is not pressed to start the selected cycle, after a delay the washer automatically turns off and all cycle settings are lost. Any water remaining in the drum will be drained.

4 Cycle Modifier Buttons

- Use these buttons to adjust the wash temperature, spin speed and soil level settings for the selected cycle.
- The current settings are shown in the display.
- Press the button for that option to select other settings.

5 Option and Extra Function Buttons

- These buttons allow you to select additional cycle options. Certain buttons also allow you to activate special functions by pressing and holding the button for 3 seconds.

Remote Start

Use a smartphone to control your washer remotely.

- For more information, see SMART FUNCTIONS in this manual.

Wi-Fi

When the washer is connected to a home Wi-Fi network, the  icon on the control panel is lit.

- To connect the washer to the LG ThinQ application, press and hold the Temp. button for 3 seconds.

Time and Status Display

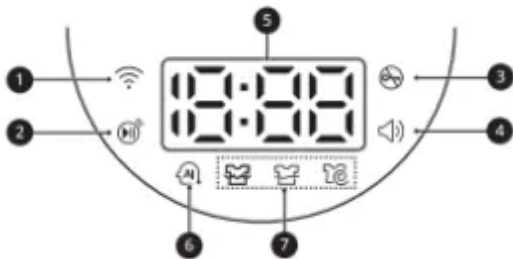

1 Wi-Fi Indicator

- This indicator is lit when the product is connected to a home Wi-Fi network.

2 Remote Start Indicator

- This indicator lights up when the Remote Start feature is activated.

3 Door Lock Indicator

- This indicator lights up when the cycle starts and the door is locked.
- The indicator light stays on until the cycle is paused, stopped or has finished.

4 Signal Indicator

- This indicator lights up when the end-of-cycle and button tones are turned on.

5 Estimated Time Remaining

- When a cycle is selected, the default time for that cycle is displayed. This time will change as modifiers or options are selected.
- If the display shows , then the time will be displayed after the load sensing has detected the load size.
- The time shown is only an estimate. This time is based on normal operating conditions. Several external factors (load size, room temperature, incoming water temperature, etc.) can affect the actual time.

NOTE

- Once the Start/Pause button is pressed, the washer will measure the size of the load. The estimated time may change once the load size has been measured.

6 AI DD Indicator

- This feature offers optimized washing by detecting the load size and laundry characteristics.
- The indicator lights up when the Normal cycle is selected with a Warm wash temperature setting.

NOTE

- The AI DD functionality may vary depending on the environment and model.

7 Cycle Status Indicators

- These LEDs will blink when a cycle is selected to indicate which stages will run.
- When a cycle is running, the LED for the active stage will blink, and the LEDs for the remaining stages will remain steady. Once a stage is complete, the LED will turn off. If a cycle is paused, the active stage LED will stop blinking.

Wash Cycles

The wash cycles are designed for specific types of wash loads. Select the cycle that best matches the load contents for maximum wash performance and fabric care. See Sorting Laundry section for best results, and follow the fabric care labels on your garments. For a guide to fabric care symbols, see Sorting Laundry section.

Cycle Guide

Turn the knob or press the button to select the desired cycle. When you select a wash cycle, the light for the corresponding wash cycle will turn on.

NOTE

- Whenever load weights are mentioned, assume 1 lb (0.45 kg) = 1 thick bath towel (dry).

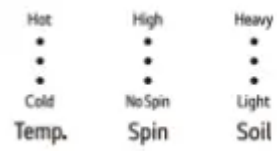

- Temperature: Cold > Cool > Warm > Very Warm > Hot
- Spin: No Spin > Low > Medium > Medium High > High
- Soil: Light > Medium Light > Normal > Medium Heavy > Heavy

Cycle	Normal	
Description	Use to wash all normal items such as cotton, linen, shirts, jeans or mixed loads, except delicate fabrics such as wool or silk. <ul style="list-style-type: none"> Pressing the Start/Pause button without selecting a cycle will cause the Normal cycle to begin immediately, using the default settings. 	
Wash Temp.	Default: Warm	Available: All
Spin Speed	Default: Medium High	Available: High, Medium High, Medium, Low
Soil Level	Default: Normal	Available: All

Cycle	Bedding	
Description	Suitable for washing blankets or bulky items which have difficulty absorbing water, such as pillows, blankets, comforters, sheets or pet bedding. <ul style="list-style-type: none"> Do not use this cycle to wash a mixed load of bedding and non-bedding items. Do not mix large/bulky items with smaller articles of clothing. Do not wash excessively large items. If large/bulky items do not fit easily into the tub, there may not be enough room for them to move during washing. 	
Wash Temp.	Default: Warm	Available: Very Warm, Warm, Cool, Cold
Spin Speed	Default: Medium	Available: Medium, Low, No Spin
Soil Level	Default: Normal	Available: All

Cycle	Delicates	
Description	Suitable for washing dress shirts/blouses, nylons, lingerie, or sheer and lacy clothes which can easily be damaged. (less than 8 lb (3.63 kg))	
Wash Temp.	Default: Cool	Available: Warm, Cool, Cold
Spin Speed	Default: Medium	Available: Medium, Low, No Spin



Cycle	Delicates	
Soil Level	Default: Normal	Available: All

Cycle	Heavy Duty	
Description	Suitable for washing heavily soiled laundry, such as cotton fabrics, using more powerful wash motions. <ul style="list-style-type: none"> When washing large loads, there will be brief periods of 2 minutes or more without agitation. These soak periods are part of the cycle's design, and are normal. 	
Wash Temp.	Default: Warm	Available: All
Spin Speed	Default: High	Available: High, Medium High, Medium, Low
Soil Level	Default: Heavy	Available: All

Cycle	Speed Wash	
Description	Quickly washes lightly soiled clothing and small loads. For high wash and rinse efficiency, wash small loads of 2-3 lightly soiled garments. (less than 3 lb (1.36 kg)) <ul style="list-style-type: none"> Use very little detergent in this cycle. To add an extra rinse, use the Extra Rinse option. 	
Wash Temp.	Default: Very Warm	Available: Very Warm, Warm, Cool, Cold
Spin Speed	Default: High	Available: All
Soil Level	Default: Light	Available: All

Cycle	Downloaded (Rinse+Spin)	
Description	Use a smartphone to download a specialized cycle to this cycle position. <ul style="list-style-type: none"> The default cycle is Rinse+Spin. This cycle is also available for download. Refer to the LG ThinQ application to see the cycles available for download. 	
Wash Temp.	Default: Cool	Available: Cool
Spin Speed	Default: Medium High	Available: All
Soil Level	Default: -	Available: -

Available Options

This option is automatically included in the cycle and cannot be deselected.

NOTE

- If the Turbo Wash™ option is on, you cannot set the spin level to No Spin.

Cycle	Steam	Turbo Wash™	Extra Rinse	Pre-wash
Normal	●	●†	●	●
Bedding	●	●	●	●

Cycle	Steam	Turbo Wash™	Extra Rinse	Pre-wash
Delicates			●	●
Heavy Duty	●	●†	●	●
Speed Wash		●	●	
Downloaded default: Rinse+Spin			●	

Cycle Modifiers

About Modifier Buttons

Each cycle has default settings that are selected automatically. You can also customize these settings using the cycle modifier buttons.

- Repeatedly press the button for the desired modifier until the indicator light for the desired setting is lit.
- The washer automatically adjusts the water level for the type and size of wash load for best results and maximum efficiency.
- This is a high-efficiency washer, and the water levels may be much lower than you expect. This is normal, and cleaning/rinsing performance will not be compromised.

Hot	High	Heavy
●	●	●
●	●	●
●	●	●
Cold	No Spin	Light
Temp.	Spin	Soil

Temp.

Make sure the wash temperature is suitable for the type of load you are washing.

- Press the Temp. button repeatedly to select the wash and rinse temperature combination for the selected cycle.
- All rinses use unheated cold water.
- Cold rinses use less energy. The actual cold rinse temperature depends on the temperature of the cold water at the faucet.

Spin

Higher spin speeds extract more water from clothes, reducing drying time and saving energy.

- Press the Spin button repeatedly until the desired speed is selected.
- Some fabrics, such as delicates, require a slower spin speed.

Soil

Adjusting the soil level setting will modify the cycle times and/or wash actions.

- Press the Soil button repeatedly until the desired soil level is selected.
- The Heavy soil setting may increase cycle times. The Light soil setting may decrease cycle times.

Options and Extra Functions

Your washer includes several additional cycle options to customize cycles to meet your individual needs.

- Select the desired option after selecting the desired cycle and settings.

NOTE

- The LED for the option will light when the option is selected.
- To protect your garments, not every option is available with every cycle.
- A chime will sound twice and the LED will not light if the selected option is not allowed for the selected cycle.

Special Cycles

Sanitary

This cycle washes clothes at a high temperature.

Tub Clean

This is a special cycle designed to clean the inside of the washer.

Steam

Adding this option to a wash cycle helps provide superior cleaning performance. Using steam gives fabrics the cleaning benefits of a very hot wash.

- Steam may not be clearly visible during steam cycles. This is normal. Too much steam could damage clothing.
- Do not use steam with delicate fabrics such as wool and silk, or easily discolored fabrics.

Turbo Wash™

Adding this option reduces the cycle time while still providing similar wash performance to the same cycle without Turbo Wash™.

NOTE

- This option cannot be used with all cycles.
- This option defaults to on for Normal and Heavy Duty wash cycles.

Extra Rinse

This option adds an extra rinse to the selected cycle. Use this option to help ensure the removal of detergent or bleach residue from fabrics.

- Press the Extra Rinse button to add additional rinses to the cycle.

Using the Pre-wash Option

This option adds a pre-wash (for about 15 - 17 minutes) for improved cleaning of heavily soiled or stained clothing.

NOTE

- If you select Pre-wash after putting the detergent directly in the drum, the detergent may be washed away, reducing the washing performance.

Control Lock

Use this function to disable the controls. This function can prevent children from changing cycles or operating this washer.

NOTE

- The function does not lock the door.
- Once this function is set, all buttons are locked except the Power button.
- When the controls are locked, CL and the remaining time are alternately shown on the display during the wash cycle.
- Turning off the power will not reset this function. You must deactivate this function before you can access any other options and functions.

Locking/Unlocking the Control Panel

- 1 Turn on the power.
- 2 Press and hold the Soil button for
- 3 seconds to activate/deactivate this function.

- When the function is deactivated, a chime will sound and the remaining time for the current cycle will reappear on the display.

Signal

The washer plays a melody when the wash cycle is finished. The buttons make a sound each time a button is pressed. Use this button to turn the melody and button tones on or off.

- To turn the function on/off, press and hold the Extra Rinse button for 3 seconds.

Drum Light

The drum is equipped with a white LED light that illuminates when the washer is turned on. This light automatically turns off when the door is closed and the cycle starts.

- Press and hold the Pre-wash button for 3 seconds during the cycle to turn on the drum light.
- The drum light will turn off automatically after 4 minutes.

OPERATION-DRYER

Using the Dryer

Operation Overview

1 Clean the Lint Filter.

- If the lint filter has not already been cleaned, lift out the filter and remove the lint from the last load. This will help ensure the fastest and most efficient drying performance. Make sure to reinstall the filter, pressing down until it clicks firmly into place.

2 Load the Dryer.

- Load the dryer with the wet laundry from the washer. If the load is extra large, you may need to divide it into smaller loads for proper performance and fabric care.

3 Turn on the Dryer.

- Press the Power button to turn on the dryer. The cycle LEDs will illuminate and a chime will sound.

4 Select a Cycle.

- Press a cycle button to select a cycle. The preset temperature, dry level, and option settings for that cycle will be shown.

5 Adjust Settings.

Default settings for the selected cycle can now be changed, if desired, using the cycle modifier and option buttons.

- Not all modifiers and options are available on all cycles. A different chime will sound and the LED will not come on if the selection is not allowed.

6 Begin Cycle.

- Press the Start/Pause button to begin the cycle. The cycle can be paused at any time either by opening the door or by pressing the Start/Pause button. If the cycle is not restarted within 14 minutes of being paused, the dryer will shut off and the settings will be lost.

7 End of Cycle

- When the cycle is finished, the chime will sound. Immediately remove your clothing from the dryer to reduce wrinkling. If Wrinkle Care is selected, the dryer will tumble briefly every few minutes to help prevent wrinkles from setting in the clothes.

Check the Lint Filter Before Every Load

Always make sure the lint filter 1 is clean before starting a new load; a clogged lint filter will increase drying time. To clean, pull the lint filter straight up and roll any lint off the filter with your fingers. Push the lint filter firmly back into place. See Regular Cleaning for more information.

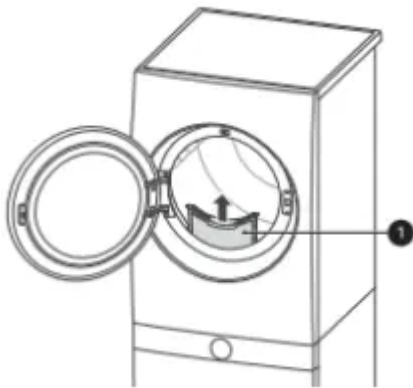

Always ensure the lint filter is properly installed before running the dryer. Running the dryer with a loose or missing lint filter will damage the dryer and articles in the dryer.

Loading the Dryer

General Tips

- Combine large and small items in the same load.
- Close zippers, hooks and drawstrings to prevent these items from snagging or tangling on other clothes.

Grouping Similar Items

For the best drying results, and to reduce the possibility of damage to clothing, sort clothes into loads that can be dried with the same drying cycle.

Different fabrics have different care requirements, and some fabrics will dry more quickly than others.

Woolen Items

Always follow fabric care labels before drying woolen items in a dryer. After the cycle, the items may still be damp. Do not repeat the cycle. Pull the items to their original shape if needed and lay them flat to finish drying.

Woven and Loopknit Materials

Some woven and loopknit materials may shrink, depending on quality.

Permanent Press and Synthetics

Do not overload your dryer. Take out permanent press items as soon as the dryer stops to reduce wrinkles.

Baby Clothes and Nightgowns

Always check the manufacturer's instructions.

Rubber and Plastics

Do not dry any items made from or containing rubber or plastics such as:

- Aprons, bibs and chair covers
- Curtains and tablecloths
- Bath mats







Fiberglass





Do not dry fiberglass articles in your dryer. Glass particles left in the dryer could be picked up by your clothes the next time you use the dryer and irritate your skin.

Fabric Care Labels

Sort and dry laundry according to care labels, size, and fabric type. Do not overload the dryer. This will save energy and time and give the best drying performance.

Many articles of clothing include a fabric care label. Using the chart below, adjust the cycle and option selections to care for your clothing according to the manufacturer's recommendations.

Tumble Dry	
Label	Directions
	Dry
	Normal
	Permanent Press / Wrinkle Resistant
	Gentle / Delicate
	Do not tumble dry
	Do not dry (used with do not wash)

Heat Setting	
Label	Directions
	High
	Medium
	Low
	No Heat / Air

Control Panel

Control Panel Features for the Dryer

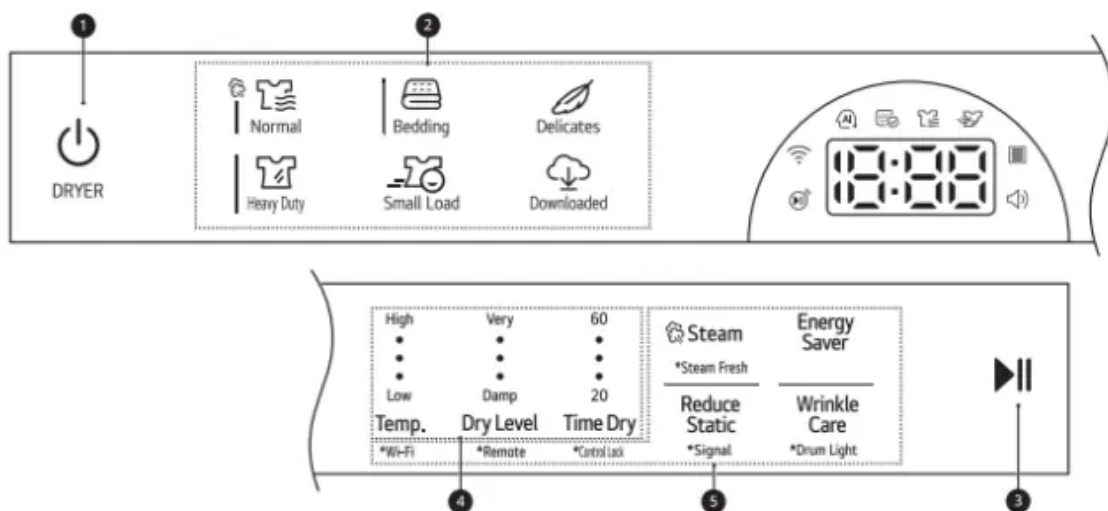

1 Power Button

- Press the button to turn the appliance on. Press again to turn the appliance off.

NOTE

Pressing the Power button during a cycle will cancel that cycle and any load settings will be lost.

2 Cycles

- Press a button to select the desired cycle. Once the desired cycle has been selected, the standard presets will be shown in the display.

3 Start/Pause Button

- Press and hold this button to start the selected cycle. If the appliance is running, use this button to pause the cycle without losing the current settings.

NOTE

If you do not press the Start/Pause button to resume a cycle within 14 minutes, the appliance turns off automatically and all cycle settings are lost.

4 Cycle Modifier Buttons

- Press these buttons to select additional cycle options. Press and hold any button marked with an asterisk for 3 seconds to activate a special function.

5 Extra Options and Functions

- Use these buttons to select the desired options for the selected cycle. Not all options are available for each cycle.

- **Remote Start**

- With the LG ThinQ app, you can use a smartphone to control your appliance remotely.

- **Wi-Fi**

- Press and hold the Temp. button for 3 seconds to initiate the connection of the appliance to the LG ThinQ application.

Time and Status Display

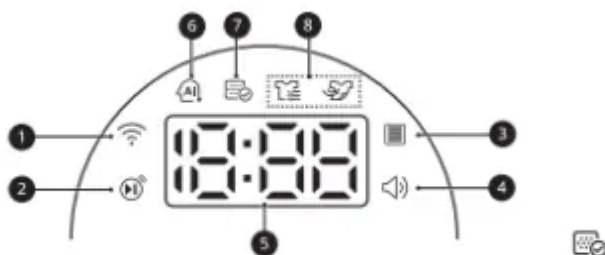

1 Wi-Fi Indicator

- This indicator is lit when the product is connected to a home Wi-Fi network.

2 Remote Start Indicator

- This indicator lights up when the Remote Start feature is activated.

3 Flow Sense Indicator

- The Flow Sense duct blockage sensing system detects and alerts you to blockages in the ductwork that reduce exhaust flow from the dryer. Maintaining a clean exhaust system improves operating efficiency and helps minimize service calls, saving you money.

4 Signal Indicator

- This indicator lights up when the end-of-cycle and button tones are turned on.

5 Estimated Time Remaining

- When a drying cycle is selected, the estimated drying time for the selected cycle is displayed. This time will change if you select extra options for the cycle.
- The cycle time on Sensor Dry cycles may fluctuate as the appliance recalculates drying time for optimal results.



6 AI Sensor Dry Indicator

- This feature optimizes drying times and temperatures by detecting the laundry's characteristics. The indicator lights up when the Normal cycle is selected with the Normal dry level, except when the Energy Saver option is turned on.

7 Lint Filter Status Indicator

-  lights up at the beginning of the cycle to remind you to check the lint filter. It also lights up if the lint filter needs to be cleaned or is missing.
 - If the lint filter is not inserted, the icon will light up and the appliance will not operate.

8 Cycle Status Indicators

-  lights up when the appliance is in the drying stage.
-  lights up when the appliance is in the cool down stage.

Dry Cycles

Cycle Guide

The appliance automatically sets the dryness level and temperature at the recommended setting for each cycle. The estimated time remaining will be shown in the display.



- Temperature: Low > Medium Low > Medium > Medium High > High
- Dry Level: Damp > Less > Normal > More > Very

Cycle	Normal	
Description	Use this cycle for drying all normal items such as cotton, linen, shirts, jeans or mixed loads, except delicate fabrics such as wool or silk.	
Temp.	Default: Medium High	Available: Medium High
Dry level	Default: Normal	Available: All

Cycle	Bedding	
Description	Use this cycle for drying blankets or bulky items such as pillows, blankets, comforters, sheets or pet bedding.	
Temp.	Default: Medium	Available: Medium
Dry level	Default: Normal	Available: Very, More, Normal

Cycle	Delicates	
Description	Use this cycle for drying dress shirts/blouses, nylons, lingerie, or sheer and lacy clothes which can easily be damaged.	
Temp.	Default: Medium Low	Available: Medium Low
Dry level	Default: Normal	Available: All

Cycle	Heavy Duty	
Description	Use this cycle for drying heavy-duty clothes like jeans or garments that need extra drying.	
Temp.	Default: High	Available: High
Dry level	Default: Normal	Available: All

Cycle	Small Load	
Description	Use this cycle for drying light or small items. (up to 3 items)	
Temp.	Default: High	Available: High
Dry level	Default: Normal	Available: Very, More, Normal

Cycle	Downloaded (Perm. Press)	
Description	Use a smartphone to download a specialized cycle to this cycle position. <ul style="list-style-type: none"> • The default cycle is Perm. Press. This cycle is also available for download. • Refer to the LG ThinQ application to see the cycles available for download. 	
Temp.	Default: Medium	Available: Medium
Dry level	Default: Normal	Available: All

Available Options

† This option is automatically included in the cycle and can be deselected.



NOTE

- The Energy Saver option is set to on by default. If you turn on the dryer and set the Energy Saver option to off, the Energy Saver option is turned off when you turn on the dryer.

Cycle	Steam	Winkle Care	Reduce Static	Energy Saver
Normal		●	●	●†
Bedding	●		●	
Delicates		●	●	
Heavy Duty	●	●	●	
Small Load		●		
Downloaded default: Perm. Press	●	●	●	

Cycle Modifiers

About Modifier Buttons

Each cycle has default settings that are selected automatically. Customize these settings using the cycle modifier buttons. Press the button for the desired modifier to open the modifier's screen.



Temp.

Use this button to adjust the temperature setting. This allows precise care of fabrics and garments. Press the Temp. button repeatedly to scroll through available settings.

Dry Level

Use this button to select the dryness level for the cycle. Press the Dry Level button repeatedly to scroll through available settings.

- The appliance will automatically adjust the cycle time according to the selected dryness level. Selecting More or Very will increase the cycle time, while Less or Damp will decrease the cycle time.
- Use a Less or Damp setting for items that you wish to iron.

Time Dry

Use this button to manually select the drying time, from 20 to 60 minutes, in 10-minute increments.

- Use this for small loads or to remove wrinkles.

Options and Extra Functions

Your dryer includes several additional cycle options to customize cycles to meet your individual needs.

Select the desired option after selecting the desired cycle and settings.

NOTE

- The LED for the option will light up when the option is selected.
- To protect your garments, not every option is available with every cycle.
- A chime will sound twice and the LED will not light up if the selected option is not allowed for the selected cycle.

Steam

Adding the Steam option to a dry cycle helps reduce wrinkles and odor in fabrics.

WARNING

- Do not touch the door during steam cycles. The door surface can become very hot.
- Do not attempt to reach into the dryer during a steam cycle. Steam can cause severe burns.

NOTE

- Steam may not be clearly visible during steam cycles. This is normal.
- Do not use steam with delicate fabrics such as wool, silk, or easily discolored fabrics.
- When the filter/duct is clogged, this option may not have optimal results.
- When the steam function is operating, the drum will stop to allow steam to stay in the drum.

Steam Fresh

This cycle uses the power of steam to quickly reduce wrinkles and odors in fabrics. It brings new life to wrinkled clothes that have been stored for an extended time and makes heavily wrinkled clothes easier to iron. It can also be used to help reduce odors in fabrics.

1 Press the Power button to turn on the dryer.

2 Press and hold the Steam button for 3 seconds.

3 To add an option, select Wrinkle Care.

4 Press Start/Pause to start the cycle.

NOTE

- Steam may not be clearly visible during the steam cycles. This is normal.
- Do not use Steam Fresh with items such as wool, wool blankets, leather jackets, silk, wet clothes, lingerie, foam products, or electric blankets.

Wrinkle Care

Selecting this option will tumble the load periodically for up to 3 hours after the selected cycle, or until the door is opened. This is helpful in preventing wrinkles when you are unable to remove items from the dryer immediately.

Press the Wrinkle Care button before you start a drying cycle.

NOTE

- When the option is set, a rectangle with a dashed line and ENd appears on the display until the feature is off.
- When the option is set, only the Power button works after the drying cycle ends.
- When a drying cycle is running, pause the cycle first to set the option.
- Always turn off the appliance before unloading the clothes.

Reduce Static

This option injects steam late in the drying cycle to reduce the static electricity caused by dry fabrics rubbing together.

Energy Saver

This option helps to reduce the energy consumption of the Normal cycle, depending on the load size. When the Energy Saver option is selected, the cycle begins with an air dry section and the drying time is increased.

Control Lock

Use this function to disable the controls. This function can prevent children from changing cycles or operating this dryer.

NOTE

- The function does not lock the door.
- Once this function is set, all buttons are locked except the Power button.
- When the controls are locked, CL and the remaining time are alternately shown on the display during the dry cycle.
- Turning off the power will not reset this function. You must deactivate this function before you can access any other options and functions.

Locking/Unlocking the Control Panel

- 1 Turn on the power.

2 Press and hold the Time Dry button for 3 seconds to activate/deactivate this function.

- When the function is deactivated, a chime will sound and the remaining time for the current cycle will reappear on the display.

Signal

The dryer plays a melody when the dry cycle is finished. The buttons make a sound each time a button is pressed. Use this button to turn the melody and button tones on or off.

- To turn the function on/off, press and hold the Reduce Static button for 3 seconds.

Drum Light

The drum is equipped with a white LED light that illuminates when the dryer is turned on. This light automatically turns off when the door is closed and the cycle starts.

- Press and hold the Wrinkle Care button for 3 seconds during the cycle to turn on the drum light.
- The drum light will turn off automatically after 4 minutes.

SMART FUNCTIONS

Using LG ThinQ Application

The LG ThinQ application allows you to communicate with the appliance using a smartphone.

LG ThinQ Application Features

- Remote Start
 - Control the appliance remotely from the LG ThinQ application.
- Downloaded
 - Download new and specialized cycles that are not included in the standard cycles on the appliance. Once cycle download is completed in the appliance, the product keeps the downloaded cycle until a new cycle is downloaded.
- Cloud Cycle
 - The Cloud cycles include many cycles which are started from the Cloud and offer various options. However, the downloaded cycle is deleted from the appliance when the power is turned off.
- Tub Clean Coach (Washer)
 - Find out how many cycles remain before it is time to run the Tub Clean cycle.

- Venting Tips (Dryer)
 - Access tips for optimizing dryer ventilation.
- Energy Monitoring
 - Keep track of the washer's power consumption and how it is affected by your selected wash cycles and options.
- Smart Diagnosis™
 - This function provides useful information for diagnosing and solving issues with the appliance based on the pattern of use.
- Push Alerts
 - When the cycle is complete or the appliance has problems, you will receive a push message.
- Settings
 - Set various options on the appliance and in the application.

NOTE

- If you change your wireless router, Internet service provider, or password, delete the connected appliance from the LG ThinQ application and connect it again.
- This information is current at the time of publication. The application is subject to change for product improvement purposes without notice to users.

Before Using LG ThinQ Application

1 Check the distance between the appliance and the wireless router (Wi-Fi network).

- If the appliance is too far from the router, the signal strength becomes weak. It may take a long time to connect or installation may fail.

2 Turn off the Mobile data or Cellular Data on your smartphone.

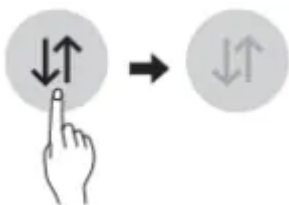

3 Connect your smartphone to the wireless router.



Installing the LG ThinQ Application

Search for the LG ThinQ application from the Google Play Store or Apple App Store on a smartphone. Follow instructions to download and install the application.

Using the Washer/Dryer Remotely

Remote Start

Use a smartphone to control your appliance remotely. You can also monitor your cycle operation so you know how much time is left in the cycle.

Using Remote Start

- 1 Load the laundry.
- 2 Press the Power button.
- 3 Press and hold the Remote button for 3 seconds to enable the remote control function.
- 4 Start a cycle from the LG ThinQ application on your smartphone.

NOTE

- Once this function is enabled, you can only start a cycle from the LG ThinQ smartphone application. If the cycle is not started, the appliance will wait to start the cycle until it is turned off remotely from the application or this function is disabled.
- If the door has been opened, you cannot start a cycle remotely.

Disabling Remote Start Manually

When the function is activated, press and hold the Remote button for 3 seconds.

Downloaded Cycle

You can download new and specialized cycles that are not included in the standard cycles on the appliance.

Appliances that have been successfully connected can download a variety of specialty cycles specific to the appliance.

Once cycle download is completed in the appliance, the product keeps the downloaded cycle until a new cycle is downloaded.

NOTE

Only one downloaded cycle can be stored on the appliance at a time.

Cloud Cycle

Use the LG ThinQ app to start cycles with various options. Cloud cycles are deleted from the appliance once the power is turned off.

Wireless LAN Module Specifications

Model: LCW-004

Frequency Range: 2412 - 2462 MHz

Output Power (Max): < 30 dBm

FCC Notice

The following notice covers the transmitter module contained in this product.

This equipment has been tested and found to comply with the limits for a Class B digital device, pursuant to Part 15 of the FCC Rules. These limits are designed to provide reasonable protection against harmful interference in a residential installation. This equipment generates, uses, and can radiate radio frequency energy and, if not installed and used in accordance with the instructions, may cause harmful interference to radio communications. However, there is no guarantee that interference will not occur in a particular installation. If this equipment does cause harmful interference to radio or television reception, which can be determined by turning the equipment off and on, the user is encouraged to try to correct the interference by one or more of the following measures:

- Reorient or relocate the receiving antenna.
- Increase the separation between the equipment and the receiver.
- Connect the equipment to an outlet on a circuit different from that to which the receiver is connected.
- Consult the dealer or an experienced radio/TV technician for help.

This device complies with part 15 of the FCC Rules. Operation is subject to the following two conditions:

- (1) This device may not cause harmful interference and
- (2) This device must accept any interference received, including interference that may cause undesired operation.

Any changes or modifications in construction of this device which are not expressly approved by the party responsible for compliance could void the user's authority to operate the equipment.

FCC RF Radiation Exposure Statement

This equipment complies with FCC radiation exposure limits set forth for an uncontrolled environment. This transmitter must not be co located or operating in conjunction with any other antenna or transmitter.

This equipment should be installed and operated with a minimum distance of 20 cm (7.8 inches) between the antenna and your body. Users must follow the specific operating instructions for satisfying RF exposure compliance.

Smart Diagnosis™ Function

Use this feature to help you diagnose and solve problems with your appliance.

NOTE

- For reasons not attributable to LGE's negligence, the service may not operate due to external factors such as, but not limited to, Wi-Fi unavailability, Wi-Fi disconnection, local app store policy, or app unavailability.
- The feature may be subject to change without prior notice and may have a different form depending on where you are located.

Using LG ThinQ to Diagnose Issues

If you experience a problem with your Wi-Fi equipped appliance, it can transmit troubleshooting data to a smartphone using the LG ThinQ application.

- Launch the LG ThinQ application and select the Smart Diagnosis™ feature in the menu. Follow the instructions provided in the LG ThinQ application.

Using Audible Diagnosis to Diagnose Issues

Follow the instructions below to use the audible diagnosis method.

- Launch the LG ThinQ application and select the Smart Diagnosis™ feature in the menu. Follow the instructions for audible diagnosis provided in the LG ThinQ application.

1 Press the Power button to turn on the appliance.

- Do not press any other buttons.

2 Hold the mouthpiece of your phone in front of the appliance.

- Washer: Hold the phone to the right of the Start/Pause button.
- Dryer: Hold the phone to the left of the Power button.

3 Press and hold the Steam + Extra Rinse(Washer) / Steam + Reduce Static (Dryer) buttons for 3 seconds or until the audible tones start. Hold the smartphone mouthpiece to the logo until the data transfer is complete.

- Keep the smartphone in place until the data transfer has finished. Time remaining for data transfer is displayed.

4 After the data transfer is complete, the diagnosis will be displayed in the application.

MAINTENANCE

Washer

Regular Cleaning

Care after Wash

After the cycle is finished, wipe the door and the inside of the door seal to remove any moisture.

- Wipe the body of the washer with a dry cloth to remove any moisture.
- Leave the door open to dry the drum interior.

Cleaning the Exterior

Proper care of your washer can extend its life.

Door:

Wash with a damp cloth on the outside and inside and then dry with a soft cloth.

Exterior:

- Immediately wipe off any spills.
- Wipe with a damp cloth.
- Do not touch the surface or the display with sharp objects.

Cleaning the Drum

Over time, residue may build up in the drum, leading to mildew or a musty odor. Run the Tub Clean cycle monthly to remove residue and prevent odor.

NOTE

- Make sure to run the Tub Clean cycle only when the drum is empty. Never load laundry while using this cycle. The laundry may be damaged or contaminated with cleaning products.
- Run the cycle more often under heavy use conditions or if odor is already present.
- If mildew or musty smell already exists, run this cycle once a week for three consecutive weeks.

1 Remove any clothing from the drum.

2 Add cleaning agents.

Cleaner - Instructions

Drum cleaner

- Add to main detergent compartment of detergent dispenser Lime scale remover

Liquid chlorine bleach

- Add to bleach compartment of detergent dispenser.

Powdered cleaner

- Pull out liquid detergent cup before adding to main detergent compartment

Cleaning tablets

- Place directly into the washer drum.
- For other drum cleaning products, follow the cleaner manufacturer's instructions and recommendations.
- Do not exceed the maximum fill line when adding bleach or powdered cleaners. Powdered cleaners may remain in the drum after cleaning.

3 Close the door and press the Power button.

4 Select the Tub Clean cycle and press the Start/Pause button to begin the cycle.

5 After the cycle ends, open the door and allow the drum interior to dry completely.

Automatic Alert for Tub Clean

When the power is on and the tcL message blinks on the display, it means the washer drum needs cleaning. Use the Tub Clean cycle to clean the washer drum. The frequency of the automatic alert's appearance depends on how often the washer is used. However, the message will generally appear every one to two months.

Removing Mineral Buildup

In areas with hard water, mineral scale can form on internal components of the washer. Periodically clean the mineral buildup on the internal components to extend the lifespan of the washer. Use of a water softener is recommended in areas with hard water.

- Use a descaler to remove visible mineral buildup on the washer drum.
- After descaling, always run the Tub Clean cycle before washing clothing.
- Mineral scale and other spots may be removed from the stainless steel drum using a soft cloth soaked in stainless steel cleaner.
- Do not use steel wool or abrasive cleaners.

Leaving the Door Open

After you finish using the washer, leave the door open overnight to allow air to circulate and dry the drum. This helps prevent odors.

Cleaning the Dispenser Drawer

Leaving detergent in the detergent dispenser drawer for an extended period of time or using the washer for a long period of time may cause the build-up of residue in the detergent dispenser drawer. Remove and clean the detergent dispenser drawer once or twice a month.

1 Turn off the washer, and unplug the power cord.

2 Pull the drawer straight out until it stops.

3 Press down hard on the disengage button 1 and pull the drawer completely out.

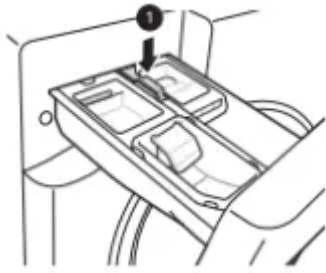

4 Remove the inserts from the drawer.

5 Clean the inserts and drawer with warm water.

- Use a soft cloth or brush to clean and to remove any residue.
- Do not use soap when cleaning the drawer and inserts.

6 Wipe off any moisture with a dry towel or cloth after cleaning.

7 To clean the drawer opening, use a small, non-metal brush to clean the recess. Remove all residue from the upper and lower parts of the recess.

8 Replace the drawer.

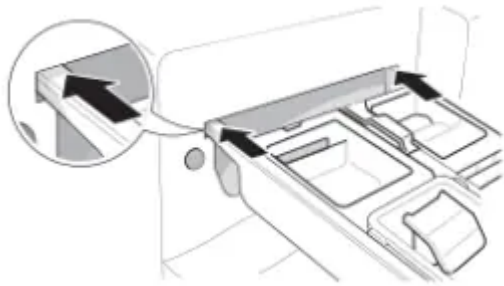

Cleaning the Door Seal

Clean the door seal once a month to prevent build-up of dirt.

1 Wear rubber gloves and protective goggles.

2 Dilute 3/4 cup (177 mL) of liquid chlorine bleach in 1 gallon (3.8 L) of water.

3 Wipe around the door seal.

- Soak a sponge or a soft cloth in this diluted solution and wipe all around the door seal.

4 Wipe up any moisture with a dry towel or cloth after cleaning.

5 Leave the door open to allow the door seal to dry completely.

Cleaning the Water Inlet Filters

If the washer does not fill properly, an error message will appear on the display. The inlet valve filter screens could be clogged by hard water scale, sediment in the water supply, or other debris.

1 Turn off the washer, and unplug the power cord.

2 Turn off hot and cold water faucets.

3 Unscrew the hot and cold water hoses from the back of the washer.

4 Remove the filters from the water valves carefully.

- Use pliers to pull out the filters from the water valves.

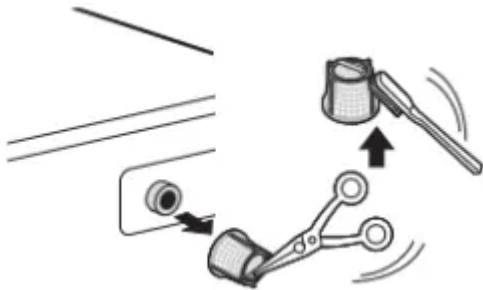

5 Remove foreign objects and soak the filters in white vinegar or a lime scale remover.

- If using a lime scale remover, follow the manufacturer's instructions. Be careful not to damage the filters while cleaning them.

6 Rinse filters thoroughly and press them back into place.

7 Flush then reattach the water hoses.

- Before reattaching the water inlet hoses, flush them by running several gallons of water through them into a bucket or drain, preferably with the faucets wide open for maximum flow.

Cleaning the Drain Pump Filter

The washer fails to drain if the drain pump filter is clogged. Periodically clean the drain filter to prevent clogging with foreign objects.

1 Turn off the washer, and unplug the power cord.

2 Open the drain pump filter cover.

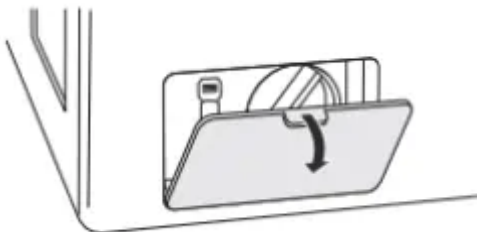

3 Drain any remaining water.

- Unclip the drain hose and remove the plug from the drain hose to drain the remaining water.



4 Remove the pump filter.

- Twist the pump filter counterclockwise to remove.



5 Clean the pump filter and opening.



6 Reassemble the plug onto the drain hose and reclip the drain hose.

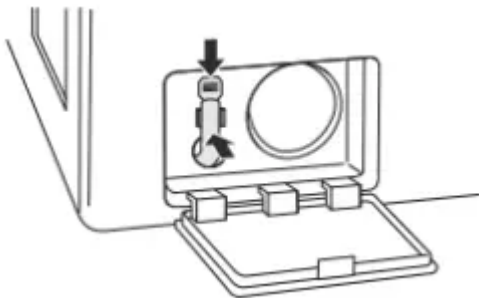

7 Insert the drain pump filter and twist it clockwise

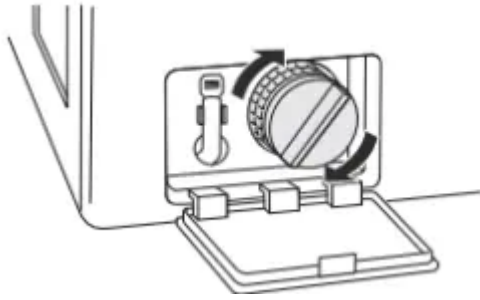

8 Close the drain pump filter cover.

Care in Cold Climates

Storing the Appliance

If the washer will not be used for an extended period of time and is in an area that could be exposed to freezing temperatures, follow these steps to protect the washer from damage.

1 Turn off the washer, and unplug the power cord.

2 Turn off the water faucets.

3 Disconnect the water inlet hoses. Drain any water from the hoses.

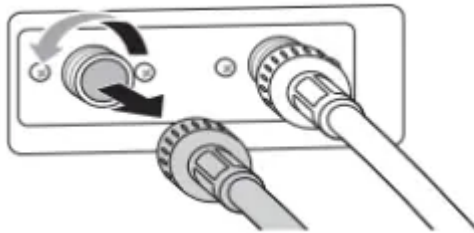

4 Plug the power cord into a properly grounded electrical outlet.

5 Add 1 gallon of nontoxic recreational vehicle (RV) antifreeze to the empty drum and close the door.

- Never use automotive antifreeze.

6 Turn on the washer and press the Spin button.

7 Press the Start/Pause button to start the drain pump for 1 minute.

- This will expel some of the antifreeze, leaving enough to protect the washer from damage.

8 Turn off the washer and unplug the power cord.

9 Dry the drum interior with a soft cloth, and close the door.

10 Store the washer in an upright position.

11 Remove the inserts from the dispenser. Drain any water in the compartments and let them dry.

12 To remove the antifreeze from the washer after storage, run the Speed Wash cycle using detergent.

- Do not add laundry to this cycle.

When the Water Inlet Hoses Are Frozen

1 Turn off the washer, and unplug the power cord.

2 Turn off the faucets connected to the water inlet hoses.

3 Pour hot water on the frozen faucets to thaw the water inlet hoses and remove the water inlet hoses.

4 Immerse the water inlet hoses in hot water to thaw them

5 Reconnect the water inlet hoses to the water inlets of the washer and to the faucets.

- See Connecting the Water Inlet Hoses for details.

6 Turn on the faucets.

7 Press the Power button to turn on the washer.

8 Press the Spin button to operate spin only cycle for draining and spinning.

9 Press the Start/Pause button.

When the Drain Hose is Frozen

1 Pour hot water in the washer drum and close the door.

2 Wait for 1 - 2 hours.

3 Press the Power button.

4 Press the Spin button to operate spin only cycle for draining and spinning.5 Press the Start/Pause button to make sure the water drains.

Dryer

Regular Cleaning

Cleaning the Exterior

Proper care of your appliance can extend its life. The outside of the appliance can be cleaned with warm water and a mild, nonabrasive household detergent. Immediately wipe off any spills with a soft, damp cloth.

NOTE

- Do not use methylated spirits, solvents, or similar products.
- Never use steel wool or abrasive cleansers; they can damage the surface.

Cleaning the Interior

- Wipe around the door opening and seal with a soft, damp cloth to prevent lint and dust buildup that could damage the door seal.
- Clean the window with a soft cloth dampened with warm water and a mild, nonabrasive household detergent. Then wipe dry.
- The stainless steel drum can be cleaned with a conventional stainless steel cleaner, used according to the manufacturer's specifications. Never use steel wool or abrasive cleansers; they may scratch or damage the surface.

Cleaning Around and Under the Appliance

Vacuum lint and dust from around the dryer and underneath it regularly.

Maintaining Ductwork

Vent ductwork should be checked for lint build up once per month and cleaned at least once per year. If any noticeable reduction in airflow or drying performance occurs, immediately check ductwork for obstructions and blockages and contact a qualified technician or service provider.

Cleaning the Lint Filter

Always clean the lint from the filter after every cycle.

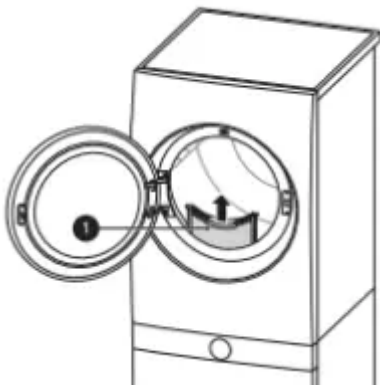

1. Lint Filter

To clean the lint filter, open the dryer door and pull the lint filter straight up. Then:

1 For everyday cleaning, roll any lint off the filter with your fingers, or

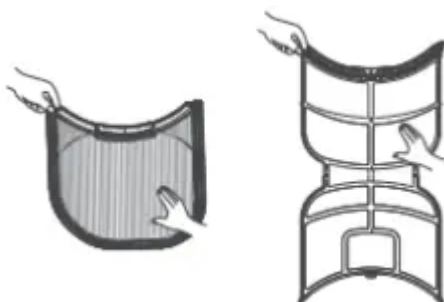

2 Vacuum the lint filter.

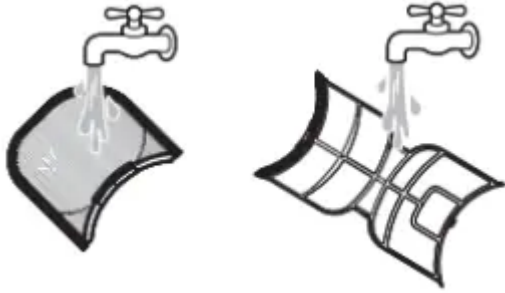

3 If the lint filter has become very dirty or clogged with fabric softener, wash the lint filter in warm, soapy water and allow it to dry thoroughly before reinstalling.

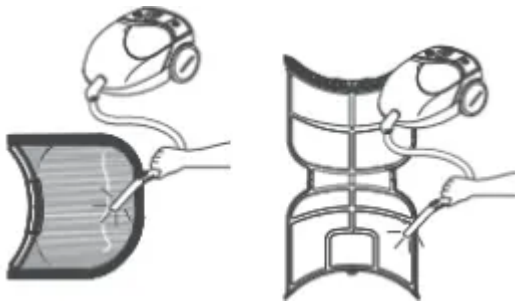

TROUBLESHOOTING

The appliance is equipped with an automatic error-monitoring system to detect and diagnose problems at an early stage. If the appliance does not function properly or does not function at all, check the following before you call for service.

Washer

FAQs: Frequently Asked Questions

Q: Why does my washer make loud banging noises while it is filling with water?

A: This is actually a problem with the plumbing in your home. When the water valve in the washer shuts off, it can cause pipes in your home to move, resulting in a loud banging noise. This effect, called water hammer, can be reduced by installing an item called a water hammer arrestor. Add-on arrestors can be purchased through your local hardware or home improvement store.

Q: Why is there so little water in my washer? How can it clean the clothes?

A: HE (High-Efficiency) washers are designed to properly wash your laundry while using a minimum amount of water and energy. Because the water volume is low, the small amount of detergent used is more concentrated in the water, resulting in excellent cleaning performance.

Q: When I press a button, why does my washer beep and then nothing happens?

A: The Control Lock feature is turned on. To turn it off, turn on the washer, then press and hold the button that has Control Lock on or under it for 3 seconds.

Q: Where should I pour the powdered laundry products when doing my laundry?

A: If you are using powdered laundry detergent, load it in the main detergent dispenser after removing the liquid detergent insert. Powdered laundry agents or powdered color safe bleach should be put directly into the drum. These products can be put in the empty drum before loading or on top of the laundry after loading the washer.

Error Messages

IE INLET ERROR

- Water supply faucets are not fully open.
 - Make sure that the water faucets are fully open.
- Water inlet hoses are kinked, pinched, or crushed.
 - Make sure that the hoses are not kinked, pinched or crushed behind or under the washer. Be careful when moving the washer during cleaning or maintenance.
- Water inlet filters are clogged.
 - Clean the inlet filters. See MAINTENANCE.
- Water supply pressure to faucet or house is too low.
 - Check another faucet in the house to make sure that household water pressure is adequate and flow is not restricted.
 - Disconnect the water inlet hoses from the washer and run a few gallons of water through the hoses to flush out any dirt.
 - If flow is too low, contact a plumber to have the water supply lines repaired.
- Water supply connected with leak-limiting hoses.
 - The use of hoses designed to limit leaks is not recommended. Leak limiting hoses can trip falsely and prevent the washer from filling.

UE UNBALANCE ERROR

- The load is too small.
 - Add additional items to allow the washer to balance the load.

- Heavy articles are mixed with lighter items.
 - Always try to wash articles of somewhat similar weight to allow the washer to evenly distribute the weight of the load for spinning.
- The load is out of balance.
 - Manually redistribute the load if articles have become tangled, preventing the automatic rebalancing from working properly.

dE, dE 1, dE2, dE4 DOOR OPEN ERROR

- The door is not secured.
 - Close and secure the door. If the message keeps appearing, unplug the power cord and call for service.

dE WATER OUTLET ERROR

- Drain hose is kinked, pinched, or clogged.
 - Make sure that the drain hose is free of clogs or kinks and is not pinched behind or under the washer.
- The end of the drain hose is more than 96 inches (2.4 m) above the bottom of the washer.
 - Move the end of the drain hose so that it is lower than 96 inches (2.4 m).

dE TEMPERATURE SENSOR ERROR

- Control error.
 - Unplug the washer and wait 60 minutes. Reconnect power and try again.
 - If the error code is still displayed, call for service

FE OVERFLOW ERROR

- Water level is too high due to a faulty water valve.
 - Close the water faucets, unplug the washer, and call for service.

PE PRESSURE SENSOR ERROR

The water level sensor is not working correctly.

Close the water faucets, unplug the washer, and call for service.

LE MOTOR LOCKED ERROR

- A motor error has occurred.
 - Allow the washer to stand for 30 minutes and then restart the cycle.
 - If the error code is still displayed, call for service.

Sud OVERSUDSING DETECTION

- Oversudsing of detergent
 - Do not add more than the manufacturer's recommended amount of detergent.
 - If too many suds are detected during spinning, the washer stops to help prevent leaking.

PF WATER LEVEL SENSOR ERROR

- Water level is too low or high compared to the load.
 - Unplug the washer and wait for 60 minutes. Reconnect power and try again.
 - If the error code is still displayed, call for service.

FF FROZEN ERROR

- Inlet hose, drain hose or drain pump is frozen.
 - See Care in Cold Climates.

CL CONTROL LOCK FUNCTION

- The Control Lock function is on to prevent anyone from changing cycles or operating the washer.
 - Turn off the Control Lock function in the control panel. See Control Lock under Options and Extra Functions.

tcl TUB CLEAN ALARM

- It is time to run the Tub Clean cycle.
 - This is not an error code. It indicates that the Tub Clean cycle is running or needs to be run to clean the washer drum.

v5 VIBRATION SENSOR ERROR

- Vibration sensor malfunctions.
 - Call for service.

Noises

Clicking

- Door lock sounds when the door locks or unlocks.
 - Normal operation

Spraying or hissing

- Water spraying or circulating during the cycle
 - Normal operation

Humming or Gurgling

- Drain pump is pumping water from the washer at times during a cycle.
 - Normal operation

Water sloshing

- A liquid in the balance ring around the pulsator helps the basket spin smoothly.
 - Normal operation

Water being added after the washer has already begun to operate

- The washer adapts to the load size and type to add more water to the cycle as needed.
 - Normal operation
- The wash load may be unbalanced. If the washer senses that the load is unbalanced, it will stop and refill to redistribute the load.
 - Normal operation
- The washer may be diluting laundry additives to add to the wash load.
 - Normal operation

Rattling and clanking noise

- Foreign objects, such as keys, coins, or safety pins may be in drum or pump.
 - Stop the washer, check the drum and the drain filter for foreign objects.
 - If noise continues after the washer is restarted, call for service.

Thumping sound

- Heavy wash loads may produce a thumping sound.
 - This is normal, but if the sound continues, the washer is probably out of balance. Stop and redistribute wash load.
- Wash load may be out of balance.
 - Pause the cycle and redistribute the load after the door unlocks.

Vibrating noise

- Packaging materials were not removed.
 - See Unpacking and Removing Shipping Material in INSTALLATION.
- Wash load may be unevenly distributed in the drum.
 - Pause the cycle and redistribute the load after the door unlocks.
- Not all leveling feet are resting firmly and evenly on the floor.
 - See Leveling the Appliance in INSTALLATION.

- Floor is not rigid enough.
 - Make sure that the floor is solid and does not flex. See Flooring in INSTALLATION.

Squeaking noise

- Packaging materials were not removed.
 - See Unpacking and Removing shipping Material in INSTALLATION.

Banging noise when the washer is filling with water. (Water hammer)

- Plumbing in the home moves or flexes when the water valves in the washer shut off.
 - Water hammer is not caused by a defect in the washer. Install water hammer arrestors (purchased separately at hardware or home improvement store) between the fill hose and the washer for best results.
- Household water supply pressure is very high.
 - Adjust household water supply regulator to a lower pressure or contact a plumber.

Operation

Water Leaking

- Hoses are not connected correctly.
 - Check hoses and connectors for leaks, cracks, and splits.
 - Check and tighten hose connections.
- House drain pipes are clogged.
 - The washer pumps out water very rapidly. Check for water backing up out of the drain pipe during drain. If water is seen coming out of the drain, check for proper drain hose installation and check for restrictions in the drain.
 - Contact a plumber to repair drain pipe.
- Drain hose has come out of the drain connector or is not inserted far enough.
 - Tie drain hose to inlet hose or standpipe to prevent it from coming out during drain.
 - For smaller drain pipes, insert the drain hose into the pipe as far as the drain hose flange. For larger drain pipes, insert the drain hose into the pipe 1 - 2 inches past the flange.

- Oversudsing of detergent
 - Oversudsing may create leaks, and may be caused by the type and amount of detergent used. HE (High-Efficiency) detergent is the only detergent recommended. The normal amount of detergent to use is 1/4 to 1/2 of the maximum amount recommended by the detergent manufacturer.
 - Always reduce the amount of detergent if the load is small or lightly soiled, or if the water is very soft.
 - Never use more than the maximum amount recommended by the detergent manufacturer.

Excessive sudsing

Too much detergent or incorrect detergent

- HE detergents are formulated specifically for HE (High-Efficiency) washers and contain suds reducing agents. Only use detergent with the HE (High-Efficiency) logo.
- For detergent quantities refer to Detergent Use in OPERATION. If sudsing or detergent residue continues to be an issue, add an extra rinse.

Washer will not turn on.

- Power cord is not properly plugged in.
 - Make sure that the plug is plugged securely into a grounded, 3-prong, 120-VAC, 60 Hz outlet.
- House fuse is blown, circuit breaker has tripped, or power outage has occurred.
 - Reset circuit breaker or replace fuse. Do not increase fuse capacity. If the problem is a circuit overload, have it corrected by a qualified electrician.

Wash cycle time is longer than usual.

- The washer automatically adjusts the wash time for the amount of laundry, water pressure and other operating conditions.
 - This is normal. The washer adjusts cycle time automatically to provide optimal results for the selected cycle. The time remaining shown in the display is only an estimate. Actual time may vary.

Incomplete or no dispensing of detergent

- Detergent compartments clogged from incorrect filling.
 - Make sure that detergent and additives are put into the correct dispenser compartments.
 - For all detergent types, always make sure that the dispenser drawer is fully closed before the start of the cycle.

- Too much detergent used.
 - Make sure that the suggested amount of detergent is used according to the manufacturer's recommendations. You may also dilute the detergent with water to the maximum fill line on the compartment to avoid clogging. Use only HE (High-Efficiency) detergent.

NOTE

Always use as little detergent as possible. HE (High-Efficiency) washers need very little detergent to achieve optimum results. Using too much detergent will cause poor wash and rinse performance and may contribute to odors in the washer.

- Insufficient water supply
 - Make sure that both hot and cold water faucets are turned on all the way.
- Normal residue
 - It is normal for a small amount of detergent to remain in the dispenser. If this residue builds up, it can interfere with normal dispensing of detergents. Refer to the cleaning instructions.

Washer will not operate.

- Control panel has powered off due to inactivity.
 - This is normal. Press the Power button to turn on the washer.
- Washer is unplugged.
 - Make sure that the power cord is plugged securely into an electrical outlet.
- Water supply is turned off.
 - Turn both hot and cold faucets fully on.
- Controls are not set properly.
 - Make sure that the cycle was set correctly, close the door and press the Start/ Pause button to start the wash cycle.
- Door is open.
 - Close the door and make sure that nothing is caught under the door preventing it from closing completely.
- Circuit breaker/fuse is tripped/blown.
 - Check house circuit breakers/fuses. Replace fuses or reset breaker. The washer should be on a dedicated branch circuit.

- Start/Pause button was not pressed after the cycle was set.
 - Press the Power button then reselect the desired cycle and press the Start/Pause button. If the Start/Pause button is not pressed within a certain time, the washer will be turned off. (The time varies by model, from 4 to 60 minutes.).
- Extremely low water pressure.
 - Check another faucet in the house to make sure that household water pressure is adequate.
- Washer is too cold.
 - If the washer has been exposed to temperatures below freezing for an extended period of time, allow it to warm up before pressing the Power button. Otherwise, the display will not come on.

Washer is not filling properly.

- Filter is clogged.
 - Make sure that inlet filters on the fill valves are not clogged. Refer to Cleaning the Water Inlet Filters in MAINTENANCE.
- Inlet hoses may be kinked.
 - Check that inlet hoses are not kinked or clogged.
- Energy efficiency
 - This is a High-Efficiency (HE) washer. As a result, the water level settings for this washer may be different than for conventional washer.
- Insufficient water supply
 - Make sure that both hot and cold water faucets are turned on all the way.
- Washer door is open.
 - Close the door and make sure that nothing is caught under the door preventing it from closing completely.
- Water level is too low.
 - The water will not normally cover the clothes. The fill level is optimized for the wash motion to achieve the best wash performance.

Water in the washer does not drain or drains slowly.

- Drain hose is kinked, pinched, or clogged.
 - Make sure that the drain hose is free of clogs or kinks and is not pinched behind or under the washer.

- The end of the drain hose is more than 96 inches (2.4 m) above the bottom of the washer.
 - Move the end of the drain hose so that it is lower than 96 inches (2.4 m).

Bleach does not dispense.

- Bleach dispenser cover is not properly installed (on some models).
 - Make sure that the bleach cover is properly installed and snapped into place before the beginning of the cycle.
- Bleach dispenser is dirty or clogged.
 - Lift out the bleach dispenser cover and clean out the reservoir. Lint and other foreign debris that are collected inside the dispenser may prevent proper dispensing of the bleach.

Premature dispensing of bleach

- Bleach dispenser filled for future load.
 - You cannot store bleach in the dispenser for future use. The bleach will be dispensed every load.
- Overfilling the bleach dispenser
 - Overfilling the bleach dispenser will cause the bleach to dispense immediately, which will damage the laundry or the washer. Always measure bleach, but never fill above the max line on the dispenser. A half cup of bleach is sufficient for most loads. Never use more than 1 cup of bleach.

Performance

Wrinkling

- Washer is not unloaded promptly.
 - Always remove items from the washer as soon as the cycle is complete.
- Washer is overloaded.
 - The washer can be fully loaded, but the drum should not be tightly packed with items. The door of the washer should close easily.
- Hot and cold water inlet hoses are reversed.
 - Hot water rinse can set wrinkles in garments. Check the inlet hose connectors.

Staining

- Bleach or softener dispensed too soon.
 - Dispenser compartment was overfilled or closed too quickly, causing the bleach or softener to dispense immediately. Always measure bleach, and never use more than 1 cup.
- Bleach or softener was added directly to the wash load in the drum.
 - Always use the dispensers to ensure that laundry products are properly dispensed at the right time in the cycle.
- Washer was not unloaded promptly.
 - Always remove items from the washer as soon as possible after the cycle is completed.
- Clothes were not properly sorted.
 - Always wash dark colors separately from light colors and whites to prevent discoloration.
 - Never wash heavily soiled items with lightly soiled items.

Poor stain removal

- Proper options are not selected.
 - Heavier soils and tougher stains may require extra cleaning power. Select the Heavy Soil feature to boost the cleaning power of the selected cycle.
- Previously set stains.
 - Articles that have previously been washed may have stains that have been set. These stains may be difficult to remove and may require hand washing or pre-treating to aid in stain removal.

Musty or mildewy odor in the washer

- Incorrect or too much detergent has been used.
 - Use only HE (High-Efficiency) detergent in accordance with the manufacturer's instructions.
- Inside of the drum was not cleaned properly.
 - Run the Tub Clean cycle regularly.

Odor

Odor

- Some odor is caused by the rubber attached to the washing machine.
 - This odor is normal for new rubber and will disappear after the machine has been run a few times.
- If the rubber door gasket and door seal area are not cleaned regularly, odors can occur from mold or foreign substances.
 - Be sure to clean the gasket and door seal regularly and check under the door seal for small items when unloading the washer.
- Odors can occur if foreign substances are left in the drainage pump filter.
 - Be sure to clean the drainage pump filter regularly.
- Odors can occur if the drainage hose is not properly installed, causing siphoning (water flowing back inside the washing machine).
 - When installing the drainage hose, be sure that it doesn't become kinked or blocked.

Dryer

FAQs: Frequently Asked Questions

Q: When I press a button, why does my dryer beep and then nothing happens?

A: The Control Lock feature is turned on. To turn off Control Lock, turn the dryer on, then press and hold the button that has Control Lock on or under it for 3 seconds.

Q: Why does my dryer take so long to dry clothes?

A: Proper airflow is critical to the efficient operation of clothes dryers. A lint filter which is full of lint or clogged with fabric softener sheet residue can reduce the airflow to the point that the time required to dry clothing will be greatly increased.

Q: Why does my dryer start by itself every few minutes?

A: This is how the Wrinkle Care feature works. The dryer runs briefly every few minutes for up to 3 hours after the cycle finishes. This feature is designed to help prevent wrinkles from setting in when the dryer is not unloaded immediately after the cycle is finished.

Q: Why does my dryer show 3 minutes when I select the Steam Fresh™ cycle?

A: When the Steam Fresh™ cycle is selected, the dryer displays the recommended number of garments for the cycle, not the estimated cycle time, until the cycle is started. Use the Time Dry button to adjust the load size setting for the number of garments you desire.

Error Messages

†E 1 through †E 7 TEMPERATURE SENSOR ERROR

- Temperature sensor failure.
 - Turn off the appliance and call for service.

P5 POWER ERROR

- Power cord is connected incorrectly.
- Check the connection of the power cord to the terminal block.

d75, d80, d90, d95 DUCT BLOCK ERROR

- The duct work is about 75% - 95% blocked. (The error code is displayed for 2 hours only.)
 - Do not use the appliance until the exhaust system has been cleaned and/or repaired.
 - Using the appliance with a severely restricted exhaust is dangerous and could result in a fire or other property damage.
 - Check the outside dryer vent while the appliance is operating to make sure there is strong airflow. If the exhaust system is extremely long, have it repaired or rerouted.
- House exhaust system blocked.
 - Keep the area around the dryer clean and free of clutter. Check vent hood for damage or lint clogging. Make sure the area around the vent hood is clear.

CL CONTROL LOCK FUNCTION

- The Control Lock function is on to prevent anyone from changing cycles or operating the dryer.
 - Turn off the Control Lock function in the control panel. See Control Lock under Options and Extra Functions.

Operation

The Flow Sense™ () indicator remains active after clearing the restriction in the venting.

- After clearing the restrictions, the Flow Sense™ () system requires multiple, consecutive cycles to determine that the performance value has improved before the Flow Sense™ () indicator is reset.
 - If the Flow Sense™ () indicator remains active for more than five cycles after the restriction has been cleared, call for service.

Clothes take too long to dry.

- Exhaust ducts are blocked, dirty, or duct run is too long.
 - Confirm that the exhaust duct is properly configured and free of debris, lint, and obstructions. Make sure that the outside wall damper can open properly and is not blocked, jammed, or clogged.
- Load is not properly sorted
 - Separate heavy items from lightweight items. Larger and heavier items take longer to dry. Light items in a load with heavy items can fool the sensor because the light items dry faster.
- Large and heavy fabrics are loaded.
 - Heavy fabrics take longer to dry because they tend to retain more moisture. To help reduce and maintain more consistent drying times for large and heavy fabrics, separate these items into smaller loads of a consistent size.
- Dryer controls are not set properly.
 - Use the appropriate control settings for the type of load you are drying. Some loads may require an adjustment of the dry level setting for proper drying.
- Lint filter needs to be cleaned.
 - Remove the lint from the filter before every load. With the lint removed, hold the filter up to a light to see if it is dirty or clogged. With some loads that produce high amounts of lint, such as new bath towels, it may be necessary to pause the cycle and clean the filter during the cycle.
- House fuse is blown, circuit breaker has tripped, or power outage has occurred.
 - Reset circuit breaker or replace fuse. Do not increase fuse capacity. If the problem is a circuit overload, have it corrected by a qualified electrician.

- The appliance is overloaded.
 - Divide extra large loads into smaller loads for better drying performance and efficiency.
- Energy Saver option is selected. (on some models)
 - If using the Normal cycle, deselect the Energy Saver option that is selected by default. This option reduces energy use by adding an air dry section to the beginning of the cycle. It is normal to feel no heat at the beginning of the cycle while in Energy Saver mode.

The appliance will not turn on.

- Power cord is not properly plugged in.
 - Make sure that the plug is securely plugged into a grounded outlet matching the appliance's rating plate.
- House fuse is blown, circuit breaker has tripped, or power outage has occurred.
 - Reset circuit breaker or replace fuse. Do not increase fuse capacity. If the problem is a circuit overload, have it corrected by a qualified electrician.

The appliance does not heat.

- House fuse is blown, circuit breaker has tripped, or power outage has occurred.
 - Reset circuit breaker or replace fuse. Do not increase fuse capacity. If the problem is a circuit overload, have it corrected by a qualified electrician.
- Gas supply or service is turned off.
 - Confirm that the house gas shutoff and the shutoff valves of the dryer are both fully open. Even if gas is not supplied to the appliance, it will run and no error codes will display. Verify that other gas appliances in the home are working normally.
- Energy Saver option is selected. (on some models)
 - If using the Normal cycle, deselect the Energy Saver option that is selected by default. This option reduces energy use by adding an air dry section to the beginning of the cycle. It is normal to feel no heat at the beginning of the cycle while in Energy Saver mode.

Drying time is not consistent.

- Heat settings, load size, or dampness of clothing is not consistent.
 - The drying time for a load will vary depending on the size of the load, the type of fabrics, the wetness of the clothes and the condition of the lint filter. An



unbalanced load in the washer can cause poor spinning, resulting in wetter clothes which will take longer to dry.

Performance

Clothes are wrinkled.

- Clothes dried too long (overdried).
 - Overdrying a load of laundry can lead to wrinkled clothes. Try a shorter drying time or use a lower dry level setting and remove items while they still retain a slight amount of moisture.
- Clothes left in dryer too long after cycle ends.
 - Use the Wrinkle Care option. This option will tumble the clothes briefly every few minutes for up to 3 hours to help prevent wrinkling.

Greasy or dirty spots on clothes.

- Fabric softener used incorrectly.
 - Check and follow the instructions provided with your fabric softener.
- Clean and dirty clothes are being dried together.
 - Use your dryer to dry only clean items. Soil from dirty clothes can transfer to the clean clothes in the same or later loads.
- Clothes were not properly cleaned or rinsed before being placed in the dryer.
 - Stains on dried clothes could be stains that were not removed during the washing process. Make sure that clothes are being completely cleaned or rinsed according to the instructions for your washer and detergent. Some difficult soils may require pre-treating prior to washing.

Clothes are shrinking.

- Garment care instructions are not being followed.
 - To avoid shrinking your clothes, always consult and follow fabric care instructions. Some fabrics will naturally shrink when washed. Other fabrics can be washed but will shrink when dried in a dryer. Use a low or no heat setting.

Lint on clothes.

- Lint filter not cleaned properly.
 - Remove the lint from the filter before every load. With the lint removed, hold the filter up to a light to see if it is dirty or clogged. If it looks dirty, follow the cleaning instructions in the MAINTENANCE section. With some loads that

produce high amounts of lint, it may be necessary to clean the filter during the cycle.

- Laundry not sorted properly.
 - Some fabrics are lint producers (i.e., a fuzzy white cotton towel) and should be dried separately from clothes that are lint trappers (i.e., a pair of black linen pants).
- Excess static in clothes.
 - Use a fabric softener to reduce static electricity. Be sure to follow the manufacturer's instructions. Overdrying a load of laundry can cause a buildup of static electricity.
- The appliance is overloaded.
 - Divide extra large loads into smaller loads for drying.
- Tissue, paper, etc., left in pockets.
 - Check pockets thoroughly before washing and drying clothes.

Excess static in clothes after drying.

- Fabric softener is not used or is used incorrectly.
 - Use a fabric softener or the Reduce Static option, if available, to reduce static electricity. Be sure to follow the manufacturer's instructions.
- Clothes dried too long (overdried).
 - Overdrying a load of laundry can cause a buildup of static electricity. Adjust settings and use a shorter drying time. Select a lower dry level setting, if necessary.
- Drying synthetics, permanent press, or synthetic blends.
 - These fabrics are naturally more prone to static buildup. Try using fabric softener, or use a lower dry level setting and/or shorter time settings.

Clothes have damp spots after a dry cycle.

- Very large load or very small load. Single large item such as a blanket or comforter.
 - If items are too tightly packed or too sparse the sensor may have trouble reading the dryness level of the load. Use a Time Dry cycle for very small loads.
 - Large, bulky items such as blankets or comforters can sometimes wrap themselves into a tight ball of fabric. The outside layers will dry and register on the sensors, while the inner core remains damp. When drying a single bulky

item, it may help to pause the cycle once or twice and rearrange the item to unwrap and expose any damp areas.

- To dry a few remaining damp items from a very large load or a few damp spots on a large item after a sensor cycle has completed, empty the lint trap, and then set a Time Dry cycle to finish drying the item(s).

Steam Function

Water drips from nozzle when Steam cycle starts.

- This is normal.
 - This is steam condensation when Steam cycle starts. The dripping water will stop after a short time.

Steam does not generate, but no error code is shown.

- Water level error.
 - Unplug dryer and call for service.

Water drips from door during Steam cycle.

- This is normal.
 - Condensation will normally form on the inside of the dryer door during steam operation. Some condensation may drip out the bottom of the door.

Steam is not visible during Steam cycle.

- This is normal.
 - Steam vapor is difficult to see when the door is closed. However, condensation will normally form on the inside of the dryer door if the steam system is operating normally.

Drum does not turn during Steam cycle.

- This is normal.
 - The drum is turned off so that the steam vapor remains in the drum. The drum will normally turn for about 2 seconds once a minute.

Cannot see steam vapor at the beginning of cycle.

- This is normal.
 - Steam is released at different stages of the cycle for each option.

Indicator Messages

Flow Sense indicator () shows four bars during the drying cycle or the display shows d80 after drying.

- Exhaust system is too long or has too many turns/restrictions.
 - Install a shorter or straighter duct run. See the Installation Instructions for details.
- Partial blockage of the ductwork due to lint buildup or other foreign object.
 - Ductwork should be checked/cleaned immediately. Dryer can be used in this condition, but drying times will be longer and energy consumption will increase.
- The appliance has detected a restriction in the external dryer venting.
 - If exhaust restrictions are sensed by the Flow Sense system, the indicator will remain on for 2 hours after the end of the cycle. Opening the door or pressing the Power button will turn off the display.
 - This warning light is not a dryer failure and is not covered by the dryer warranty. Contact a duct cleaning service to set up an appointment to have your exhaust system cleaned and inspected.

The Flow Sense indicator () remains active after clearing the restriction in the venting.

- After clearing the restriction, the Flow Sense system requires multiple, consecutive cycles to determine that the performance value has improved before the Flow Sense indicator is reset.
 - If the Flow Sense indicator remains active for more than five cycles after the restriction has been cleared, call for service.

Check filter indicator () is on during the drying cycle.

- Lint filter not cleaned properly.
 - Remove the lint from the filter before every load. With the lint removed, hold the filter up to a light to see if it is dirty or clogged. If it looks dirty, follow the cleaning instructions. With some loads that produce high amounts of lint, it may be necessary to clean the filter during the cycle.

Common

Wi-Fi

Trouble connecting appliance and smartphone to Wi-Fi network

- The password for the Wi-Fi network was entered incorrectly.
 - Delete your home Wi-Fi network and begin the connection process again.
- Mobile data for your smartphone is turned on.
 - Turn off the Mobile data on your smartphone before connecting the appliance.
- The wireless network name (SSID) is set incorrectly.
 - The wireless network name (SSID) should be a combination of English letters and numbers. (Do not use special characters.)
- The router frequency is not 2.4 GHz.
 - Only a 2.4 GHz router frequency is supported. Set the wireless router to 2.4 GHz and connect the appliance to the wireless router. To check the router frequency, check with your Internet service provider or the router manufacturer.
- The appliance and the router are too far apart.
 - If the appliance is too far from the router, the signal may be weak and the connection may not be configured correctly. Move the router closer to the appliance or purchase and install a Wi-Fi repeater.

Warning

This content is compiled from multiple sources and is provided for reference purposes only. It may not be complete or fully applicable to all situations. If you are unable to resolve your issue, please contact the product manufacturer or an authorized service provider for official support.