

IMPORTANT SAFETY INSTRUCTIONS

SAVE THESE INSTRUCTIONS

READ ALL SAFETY WARNINGS AND INSTRUCTIONS BEFORE USING THIS PRODUCT.

WARNING: When using an electrical product, basic precautions should always be followed to avoid electric shock, fire, and/or serious injury, including the following:

- Fully assemble product prior to use.
- Operate cleaner only at voltage specified on data plate on lower handle of cleaner.
- Do not leave appliance when plugged in. Unplug from outlet when not in use and before cleaning or servicing.
- Use indoors only. Do not immerse. Use only on surfaces moistened by the cleaning process.
- To Reduce the Risk of Fire and Electric Shock due to internal component damage, use only Hoover Cleaning Fluids intended for use with this appliance. See the Cleaning Fluid section of this manual.
- Do not allow to be used as a toy. Not intended for use by children age 12 and under. Close supervision is necessary when used by or near children. To avoid injury or damage, keep children away from product, and do not allow children to place fingers or other objects into any openings.
- Use only as described in this manual. Use only Hoover's recommended attachments and products.
- Do not use product with damaged cord or plug. If product is not working as it should, has been dropped, damaged, left outdoors, or dropped into water, call customer service at 1-800-944-9200 prior to continuing use.
- Do not pull or carry by cord, use cord as a handle, close a door on cord, or pull cord around sharp edges or corners. Do not place product on cord. Do not run appliance over cord. Keep cord away from heated surfaces.
- Do not unplug by pulling on cord. To unplug, grasp the plug, not the cord.
- Do not handle plug or appliance with wet hands. Do not put any object into openings. Do not use with any opening blocked; keep free of dust, lint, hair, and anything that may reduce air flow.
- Keep hair, loose clothing, fingers, and all parts of body away from openings and moving parts.
- Turn off all controls before unplugging.

- Use extra care when cleaning on stairs. To avoid personal injury or damage, and to prevent the cleaner from falling, always place cleaner at bottom of stairs or on floor. Do not place cleaner on stairs or furniture, as it may result in injury or damage.
- Do not use to pick up flammable or combustible liquids, such as gasoline, or fine wood sandings, or use in areas where they may be present.. Connect to a properly grounded outlet only. See Grounding Instructions.
- Not intended for use on carpets.
- Do not pick up anything that is burning or smoking, such as cigarettes, matches, or hot ashes.
- Do not use without Tanks or Filters in place.
- Do not clean over floor electrical outlets.

CAUTION: TO REDUCE THE RISK OF DAMAGE:

- Avoid picking up hard, sharp objects with this product, as they may cause damage..
- Store appropriately indoors in a dry place. Do not expose machine to freezing temperatures.
- Do not use sharp objects to clean out.hose as they can cause damage. .
- To assist in reducing drying time, be certain the area is well ventilated when using detergents and other cleaners with this machine.
- With brushes on, do not allow cleaner to sit in one location for an extended period of time, as damage to floor can result..
- Water will drip from the brushes and underside of the product after use and may puddle.To avoid damage to wood and laminate flooring and to avoid potential slip hazard, after use (a) do not leave the product on wood and laminate surfaces and remove to a hard surface and (b) place unit on absorbent material (such as a towel) to soak up drips..
- Check and follow flooring Hoover's warranty and recommendations regarding the use of hard floor cleaning machines prior to using this product on your sealed hard floors..
- Use extra care when cleaning on stairs.

GROUNDING INSTRUCTIONS

This appliance must be grounded. If it should malfunction or breakdown, grounding provides a path of least resistance for electric current to reduce the risk of electric shock. This appliance is equipped with a cord having an equipment-grounding conductor (C) and grounding plug (A). The plug must be inserted into an appropriate outlet (B) that is properly installed and grounded in accordance with all local codes and ordinances.

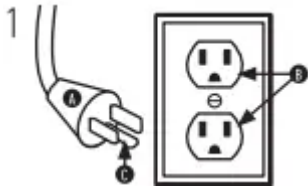

WARNING:

Improper connection of the equipment-grounding conductor can result in the risk of electric shock. Check with a qualified electrician or service person if you are in doubt as to whether the outlet is properly grounded. Do not modify the plug provided with the appliance-if it will not fit the outlet, have a proper outlet installed by a qualified electrician. This appliance is for use on a nominal 120-volt circuit and has a grounding plug that looks like the plug (A) illustrated in Fig. 1. A temporary adapter (D) may be used to connect this plug to a 2-pole receptacle (E) if a properly grounded outlet is not available (Fig. 2). The temporary adapter should be used only until a properly grounded outlet (B) can be installed by a qualified electrician (Fig. 1). The green colored rigid ear, lug, or the like (F) extending from the adapter must be connected to a permanent ground (G) such as a properly grounded outlet box cover (Fig. 2). Whenever the adapter is used, it must be held in place by a metal screw. NOTE: In Canada, the use of a temporary adapter is not permitted by the Canadian Electrical Code.

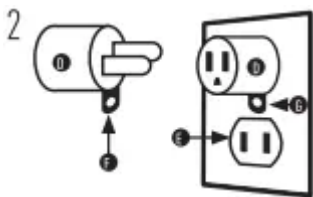

CORD STORAGE

Wrap the power cord around the cord hooks for convenient storage.

CAUTION: To reduce the risk of injury from moving parts-Unplug before servicing. Do not use cleaner without brushes in place.

LUBRICATION

The motor is equipped with bearings which contain sufficient lubrication for their lifetime. The addition of lubricant could cause damage. Do not add lubricant to motor bearings.

THERMAL PROTECTION

A thermal protector has been designed into your cleaner to protect it from overheating. When the thermal protector activates the cleaner will stop running. If this happens proceed as follows:

1. Turn cleaner OFF (and remove battery pack).
2. Empty dirty water tank.
3. Inspect the nozzle for any obstructions. Clear obstructions if present.



4. When cleaner is de-energized and motor cools for 30 minutes, the thermal protector will deactivate and cleaning may continue.

If the thermal protector continues to activate after following the above steps.

TROUBLESHOOTING

This product contains no serviceable parts.

For available replacement parts and accessories, see Hoover.com and search your model number.

If appliance is not working as it should, has been dropped, damaged, left outdoors, or dropped into water, call customer service at 1.800.944.9200 prior to continuing use. Call support available Mon-Fri 9am-6pm EST.

Always identify your hard floor cleaner by the complete model number. (The model number appears on the bottom of the cleaner.)

Cleaner won't run

1. Power cord not firmly plugged into outlet
 - Plug cord in firmly
2. Power switch not on
 - Turn power switch on

Low suction or won't

1. Dirty Water Tank full and the automatic pick up shut-off engaged
 - Empty the Dirty Water Tank
2. Make sure tanks and/or tank lids are latched in place
 - Tanks and/or tank lids not in place
3. Nozzle not in place
 - Make sure Nozzle cover is latched in place

Water puddles behind cleaner

1. Clean Water Tank not in place
 - Make sure Clean Water Tank is installed properly
2. Dirty Water Tank full
 - Empty Dirty Water Tank

Cleaner solution won't dispense

1. Tanks not in place
 - Make sure both tanks are locked in place

2. Clean Water Tank is empty

- Refill Clean Water Tank with water and solution

Brushes won't rotate

1. Brushes not in place

- Turn unit off, check brushes are locked into place

2. Debris stuck in brushes

- Remove any debris stuck between brushes

WARRANTY

LIMITED WARRANTY FOR HOOVER PRODUCT

TWO (2) YEAR LIMITED WARRANTY (DOMESTIC USE)

If this product is not as warranted, contact HOOVER Customer Service at 1-800-944-9200.

In order to make a warranty claim you must have proof of purchase and the model number for the warranted product.

WHAT THIS LIMITED WARRANTY COVERS: This limited warranty provided by Royal Appliance Mfg. Co. doing business as TTI Floor Care North America (referred to hereafter as "HOOVER" applies only to products purchased in the U.S. (including its territories and possessions, a U.S. Military Exchange or Canada. When used and maintained in normal household use and in accordance with the Owner's Guide, this product is warranted for TWOCZ) year against original defects in material and workmanship from the date of original purchase (the "Warranty Period"). If HOOVER determines that the issue you are experiencing is covered under the terms of this warranty (a "covered warranty claim") we will, at our sole discretion and free of charge (subject to the cost of shipping, either (i) repair your product (ii) ship you a replacement product, subject to availability; or (iii) in the event that the applicable parts or replacement are not reasonably available, ship you a similar product of equal or greater value. In the unlikely event that we are unable to repair your product or ship a replacement or similar product, we reserve the right, at our sole discretion, to issue you a refund or store credit (if applicable) of the actual purchase price at the time of the original purchase as reflected on the original sales receipt. Parts and replacements may be new, refurbished, lightly used, or remanufactured, in HOOVER's sole discretion.

WHO THIS LIMITED WARRANTY COVERS: This limited warranty extends only to the original retail purchaser, with original proof of purchase from HOOVER or an authorized dealer of HOOVER products, in the US, U.S. Military Exchanges, and Canada.

WHAT THIS LIMITED WARRANTY DOES NOT COVER: This warranty does not cover a product used in a commercial operation (such as maid, janitorial, and equipment rental services, or any other income-generating activity); a product that is improperly maintained; a product subjected to misuse, negligence, neglect, vandalism, or voltages other than that on the data plate of this product. This warranty does not cover products damaged by an act of God, accident, owner's acts or omissions, service of this product by other than HOOVER or a HOOVER authorized service provider (if applicable, or other acts beyond the control of HODVER. This warranty also does not cover a product used outside the country in which the product was initially purchased or resold by the original owner. Pick-up, delivery, transportation, and house calls are not covered by this warranty. In addition, this warranty does not cover any product that has been altered or modified, or repairs made necessary by normal wear or the use of other products, parts, or accessories which are either incompatible with this product or adversely affect this product's operation, performance, or durability. Normal wear items are not covered under this warranty. Depending on the product, normal wear items may include, but are not limited to, belts, filters, brush rolls, blower fans, blower and vacuum tubes, and vacuum bags and straps

OTHER IMPORTANT TERMS: This warranty is not transferable and may not be assigned. Any assignment made in contravention of this prohibition is void. This warranty shall be governed and construed under the laws of the state of North Carolina. The Warranty Period will not be extended by any replacement of batteries, parts, or products or by virtue of any repair performed under this warranty.

THIS LIMITED WARRANTY IS THE EXCLUSIVE WARRANTY AND REMEDY, AND ALL EXPRESS AND IMPLIED WARRANTIES OTHER THAN THE LIMITED WARRANTY SET FORTH ABOVE, INCLUDING IMPLIED WARRANTIES OF MERCHANTABILITY AND FITNESS FOR A PARTICULAR PURPOSE, ARE EXPRESSLY DISCLAIMED. IN NO EVENT WILL HOOVER BE LIABLE FOR ANY SPECIAL, INDIRECT, INCIDENTAL OR CONSEQUENTIAL DAMAGES OF ANY KIND OR NATURE TO OWNER OR ANY PARTY CLAIMING THROUGH OWNER, WHETHER BASED IN CONTRACT, NEGLIGENCE, TORT, OR STRICT PRODUCTS LIABILITY OR ARISING FROM ANY CAUSE WHATSOEVER, EVEN IF THIS WARRANTY FAILS OF ITS ESSENTIAL PURPOSE. TO THE EXTENT PERMITTED BY APPLICABLE LAW, NO WARRANTIES THAT ARISE BY OPERATION OF LAW, IF APPLICABLE, SHALL EXCEED THE DURATION OF THE LIMITED WARRANTY PROVIDED HEREIN. HODVER's liability for damages to you for any costs whatsoever arising out of this statement of limited warranty shall be limited to the amount paid for this product at the time of original purchase. Both the disclaimer and the limitations of liability set forth above shall apply even in the event that this limited warranty fails of its essential purpose. Some states do not allow the exclusion or limitation of incidental or consequential

damages, disclaimers of implied warranties, or limitations on the duration of implied warranties, so the above exclusions, disclaimers, and/or limitations may not apply to you. This warranty gives you specific legal rights, and you may also have other rights, which vary from state to state.

GETTING STARTED

ASSEMBLY:

1 Slide handle into base

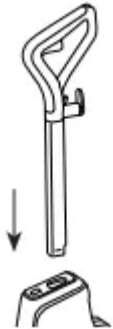

2 Attach the nozzle cover by hooks on the aligning cover to arrows on the base of the cleaner Rock the cover into place

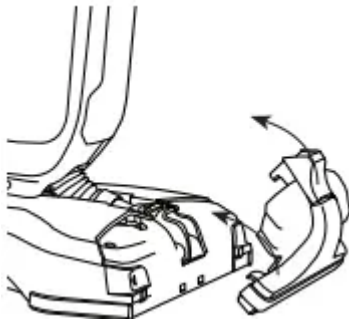

FILLING THE CLEAN WATER TANK WITH WATER AND SOLUTION:

1 Remove Clean Water Tank by squeezing release buttons, pull straight out.



2 Fill tank to fill line with warm water then fill measuring capline (3/4 oz-22ml) with cleaning solution and pour into tank

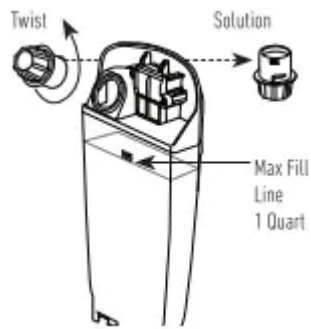

CLEANING FLUID Use only with Hoover approved Hard Floor Solutions. Visit Hoover.com/cleaning-solutions for recommended solutions Read the directions on the bottle prior to use

3 Replace cap and slide tank straight into position until latch snaps.



OPERATION

HOW TO USE:

1 Push release pedal to lower handle and power ON.

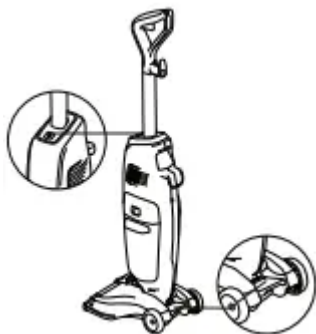

2 While squeezing trigger, push forward to wash Release trigger then pull back to dry.



HOW TO EMPTY:

1 Remove Dirty Water Tank by squeezing release buttons. pull straight out.

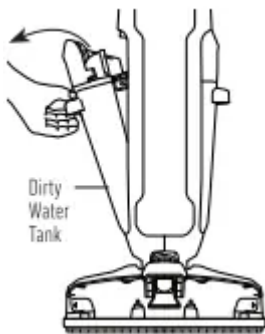

2 Unlatch to remove lid and filter basket then rinse and allow to dry fully

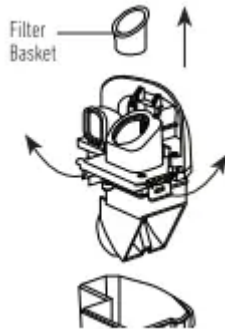

IMPORTANT: An audible change will occur when the feet are tripped and the Dirty Water Tank needs to be emptied

MAINTENANCE

HOW TO CLEAN THE NOZZLE:

- 1 Turn power OFF and unplug the power cord
- 2 Empty both tanks.
- 3 Pull to release nozzle cover.
- 4 Rinse with water and allow to dry fully.





CAUTION: To reduce the risk of injury from moving parts- Unplug before servicing
Do not use cleaner without brushes in place

HOW TO REMOVE AND CLEAN THE BRUSHES:

- 1 Place unit in upright position
- 2 Pull brush release tabs away from unit to release brushes.

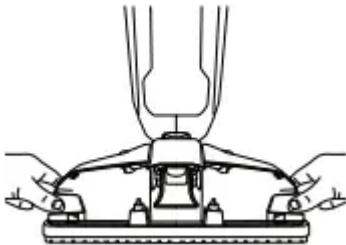

- 3 Rinse and allow to dry before reinstalling
- 4 To reinsert, line up brush connector post with slots, snap into place.

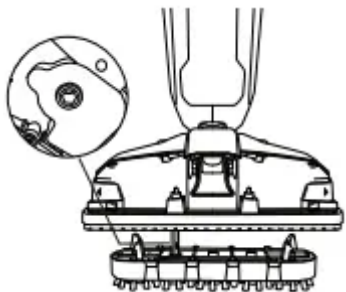

NOTE: For Best Performance, complete system care after each use.

Warning

This content is compiled from multiple sources and is provided for reference purposes only. It may not be complete or fully applicable to all situations. If you are unable to resolve your issue, please contact the product manufacturer or an authorized service provider for official support.