

## OPERATING YOUR DISHWASHER

### 1. Prepare and load the dishwasher

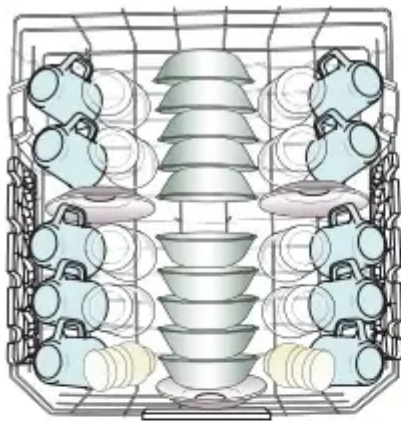

10-place load – upper rack

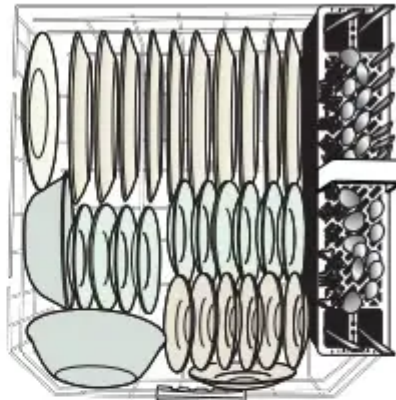

10-place load – lower rack

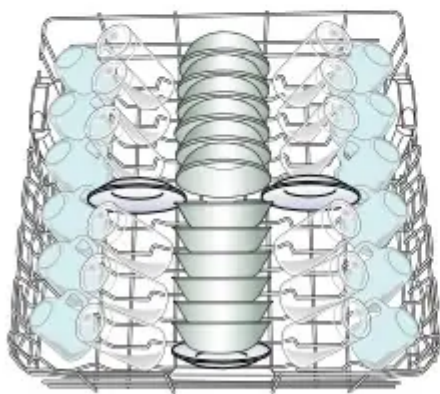

12-place load – upper rack

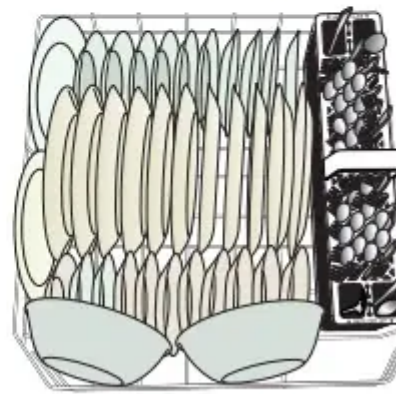

12-place load – lower rack

**IMPORTANT:** Remove leftover food, bones, toothpicks, and other hard items from dishes. Remove labels from containers before washing.

- Make sure when the dishwasher door is closed no items are blocking detergent dispenser.
- Items should be loaded with soiled surfaces facing down and inward to the spray as shown in the graphics above. This will improve cleaning and drying results. Angle dirtiest dish surface downward, allowing space for water to flow up through rack and between dishes.
- Avoid overlapping items, like bowls or plates that may trap food.
- Place plastics, small plates, and glasses in upper rack.
- Wash only items marked “dishwasher safe.”

- To avoid thumping/clattering noises during operation: Load dishes so they do not touch one another. Make sure lightweight load items are secured in racks.
- When loading silverware, always place sharp items pointing down and avoid “nesting” as shown. If your silverware does not fit into the designated slots, lift and slide covers off to remove them and mix silverware types to keep them separated.
- Use the slots in the covers and suggested loading patterns to keep your silverware separated for optimum wash. See the complete online User Instructions for detailed illustrations.

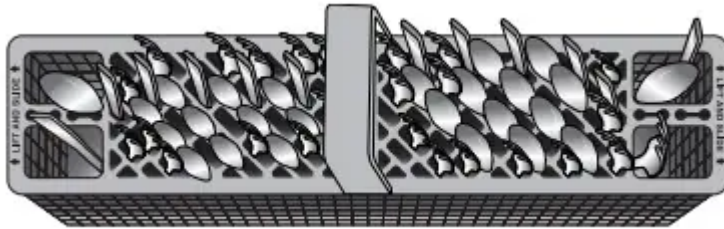

## 2. Check that all arms spin freely

Items in the rack can block the spray arms.

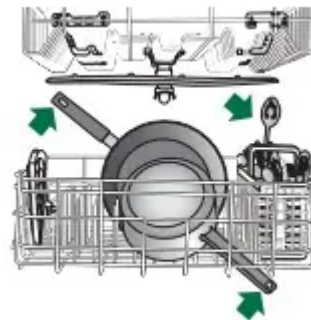

## 3. Add detergent

## Premeasured Detergents

High-quality premeasured tablets and packs are recommended for improved performance.

Quality tablets and packs have been proven better than powder, liquid, or gel detergents at reducing filming on dishes. Using tablets and packs over time will start to reduce or eliminate white film.

They are suitable for all water hardness and soil levels. Also, by using a rinse aid, you can minimize repeat buildup of white film (not all packs and tablets contain rinse aid). Always place premeasured detergents in main compartment and close lid.

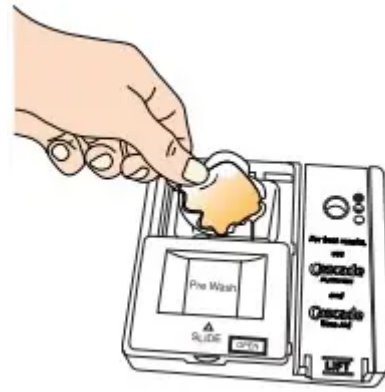

**NOTE:** Follow instructions on the package when using other dishwasher detergent types. See the complete User Instructions for more details about powders, liquids, and gels.

- Use automatic dishwasher detergent only. Add detergent just before starting a cycle.
- Fresh automatic dishwasher detergent results in better cleaning. Store tightly closed detergent container in a cool, dry place.

### To close lid



Place selected detergent in the dispenser.  
Place finger, as shown, and slide lid closed.  
Press firmly until it clicks.

### To open lid

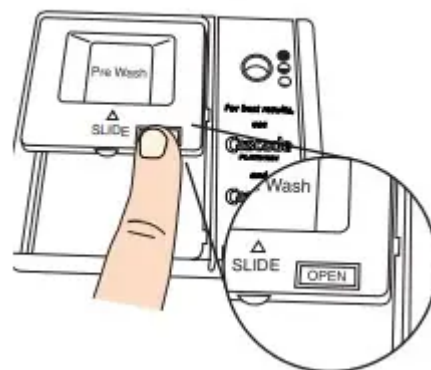

Push OPEN, as shown, and the lid will slide open.

#### 4. Add rinse aid

- Your dishwasher is designed to use rinse aid for good drying performance. Without rinse aid, your dishes and dishwasher interior will have excessive moisture. The heating and drying options will not perform as well without rinse aid.
- Rinse aid keeps water from forming droplets that can dry as spots or streaks. It also improves drying by allowing water to drain off of dishes after final rinse. Rinse aid does not adhere to dishware, and when used, it is dispensed during each cycle.
- To add rinse aid, open the dispenser lid by gently pushing in the center of the lid with your thumb while lifting up on the edge.

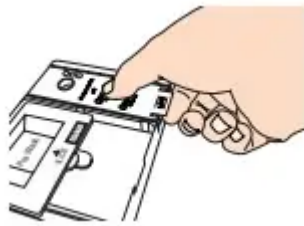

- Pour rinse aid into the opening until the indicator level shows that it is full.



- Close dispenser by pushing down gently on the lid.

NOTE: For most water conditions, the factory setting will give good results

If you are experiencing poor drying performance, you may want to try a higher setting. Turn the arrow adjuster to a higher number to increase the amount of rinse aid.



#### 5. Select a cycle

Efficient dishwashers run longer to save water and energy, just as driving a car slower saves on gas. Typical cycle time is approximately  $2^{1/2}$  hours but can take less or more time to complete depending on selections.

#### 6. Select options

You can customize your cycles by touching the options desired. If you change your mind, touch the option again to turn off the option. Not all options are available for every cycle. If an invalid option is selected for a given cycle, the lights will flash.

## 7. Follow the progress of your dishwasher

Models with handles have an LED on the front right corner of the door panel that will glow blue for washing/rinsing, red for drying, and white for complete.

Models with pocket handles on the door indicate cycle progress with LEDs on the pocket display such as Washing, Drying, Clean, and Sanitized. Also, each segment of the progress bar represents approximately 25 minutes of time remaining. Models with fan dry display a fan icon during the dry portion of the cycle.

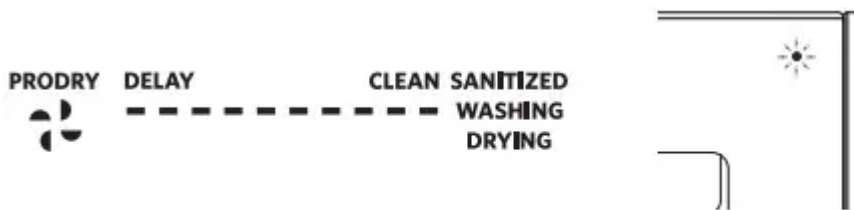

Display design varies by model

## 8. Start or resume a cycle

**NOTE:** If needed, run hot water at the sink nearest your dishwasher until water is hot. Turn off water.

Push door firmly closed within 4 seconds of touching Start/Resume. If door is not closed within 4 seconds, the Start keypad LED will flash, an audible tone will be heard, and cycle will not start.

**IMPORTANT:** If anyone opens the door (such as, for adding a dish, even during the Delay Hours option), Start/Resume keypad must be touched each time.

## CYCLE GUIDE

This information covers several different models. Your dishwasher may not have all of the cycles and options described.

**IMPORTANT:** The sensor in your dishwasher monitors the soil level. Cycle time and/or water usage can vary as the sensor adjusts the cycle for the best wash performance. If the incoming water is less than the recommended temperature or food soils are heavy, the cycle will automatically compensate by adding time, heat, and water as needed.

CYCLES		ESTIMATED WASH TIME* W/ O OPTIONS (HR:MIN)	WATER USAGE GALLONS (LITERS)
<b>ProWash</b> Soil-Sense	This cycle senses the load size, soil amount, and toughness of soil, to adjust the cycle for improved cleaning, using only the amount of water and energy needed. The ProWash™ cycle is automatically selected if you first touch the Start keypad. Includes a heated drying option.*	2:30 to 3:30	3.8 to 7.7 (14.4 to 29.3)
<b>Tough</b>	Use for hard-to-clean, heavily soiled pots, pans, casseroles, and regular tableware. Includes a heated drying option.	2:20 to 3:30	8.4 (31.7)
<b>Normal</b>	This cycle is recommended for daily, regular, or typical use to completely wash and dry a full load of normally soiled dishes. This dishwasher's government energy certifications were based on the Normal cycle with only the Heat Dry or ProDry™ option selected.**	1:50 to 3:30	2.7 to 7.9 (10.4 to 30.0)
<b>Light</b>	Use for lightly soiled items or china and crystal. Includes a heated drying option.	1:45 to 3:30	2.7 to 7.9 (10.4 to 30.0)
<b>Express Wash</b>	When you need fast results, the Express Wash will clean dishes using slightly more water and energy. Select a heated drying or extended dry option to speed drying times.	0:55 to 1:05	6.2 (23.5)
<b>Rinse Only</b>	Use for rinsing dishes, glasses, and silverware that will not be washed right away. Do not use detergent.	0:15 to 0:20	2.4 (9.0)
<b>Download</b> (on some models)	This is a specialty cycle that you select from the KitchenAid® app and download to your dishwasher. Your dishwasher remembers this cycle until you replace it by downloading another cycle from the KitchenAid® app.	Variable	Variable up to 7.87 (29.8)



\*The government energy certifications are not based on this cycle. See the Normal cycle description for the government energy certification cycle. Using the ProWash™ cycle may increase your energy usage.

\*\*No other washing and drying temperature options were selected, and the dishwasher was not subjected to truncated testing. Rinse aid was not used, and there was no detergent used in the prewash.



OPTIONS		CAN BE SELECTED WITH	WHAT IT DOES	ADDED WATER GALLONS (LITERS)	ADDED TIME TO CYCLE (HR:MIN)
Extended ProDry Prodry( on some models)	Dries dishes with heat and a fan. This option, with the use of rinse aid, will provide the best drying performance. Plastic items are less likely to deform when loaded in the top rack. Turn the ProDry™ option off for an air dry	Available with any cycle except Rinse Only	Uses the heating element, vents, and a fan to speed drying times. ProDry™ option defaults to On when any cycle is selected, except for Express Wash and Rinse Only.	ProDry™: 0:10 to 0:50 Extended ProDry™ (includes ProDry™ time): 0:40 to 1:20	0
Extended Heat Dry Heat Dry( on some models)	Dries dishes with heat. This option, with the use of rinse aid, will provide the best drying performance. Plastic items are less likely to deform when loaded in the top rack. Turn the Heat Dry option off for an air dry.	Available with any cycle except Rinse Only	Activates the heating element at the end of a wash cycle to speed drying times. Heat Dry defaults to On when any cycle is selected, except for Express Wash and Rinse Only.	Heat Dry: 0:10 to 0:50 Extended Heat Dry (includes Heat Dry time): 0:40 to 1:20	0
Sani Rinse	Sanitizes dishes and glassware in accordance with NSF International NSF/	ProWash™ Tough Normal	Increases the main wash temperature from 105°F (41°C) to	0:00 to 2:20	1.2 to 6.2 (4.8 to 23.3)



OPTIONS	CAN BE SELECTED WITH	WHAT IT DOES	ADDED WATER GALLONS (LITERS)	ADDED TIME TO CYCLE (HR:MIN)
<p>ANSI Standard 184 for Residential Dishwashers. Certified residential dishwashers are not intended for licensed food establishments. Only sanitizing cycles have been designed to meet the requirements of the NSF/ANSI 184 performance standard for soil removal and for sanitization efficacy. There is no intention, either directly or indirectly, that all cycles on a NSF/ANSI 184 certified dishwasher meet the NSF/ANSI 184 performance standard for soil removal and for sanitization efficacy.</p> <p>The Sani Rinse indicator glows at the end of the cycle if the Sani Rinse option was successfully completed. If the indicator does not activate, it is probably due to the cycle being interrupted.</p>		<p>140°F (60°C) and the final rinse from 140°F (60°C) to 155°F (68°C).</p>		



OPTIONS		CAN BE SELECTED WITH	WHAT IT DOES	ADDED WATER GALLONS (LITERS)	ADDED TIME TO CYCLE (HR:MIN)
Bottle Wash (on some models)	The upper rack has flip-up spray nozzles that reach into deeper items such as sports bottles, baby bottles, or oddly shaped items. Flip the nozzles up to use them and down to move them out of the way	ProWash™ Express Wash Tough Normal	Bottle Wash nozzles ensure interior wash and rinse coverage inside taller items, such as bottles.	0:07	0
Hi-Temp Wash  Sound On/Off Hold 3 Sec	Raises the main wash temperature to improve cleaning for loads containing tough, baked-on food.	ProWash™ Tough Normal	Raises the main wash temperature from 105°F (41°C) to either 130°F (55°C) or 140°F (60°C).	0:00 to 0:30	0 to 3.0 (0 to 11.2)



OPTIONS		CAN BE SELECTED WITH	WHAT IT DOES	ADDED WATER GALLONS (LITERS)	ADDED TIME TO CYCLE (HR:MIN)
2-4-8 Hr. Delay	<p>Runs the dishwasher at a later time or during off-peak electrical hours. Select a wash cycle and options. Touch the Delay keypad. Touch START/RESUME. Close the door firmly.</p> <p>NOTE: Anytime the door is opened (such as, to add a dish), the Start/Resume keypad must be touched again to resume the delay countdown.</p>	Available with any cycle	Delays the start of a cycle to the specified time.		0

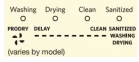

CONTROL	PURPOSE	COMMENTS
<b>Start</b> RESUME	To start or resume a wash cycle.	If the door is opened during a cycle or the power is interrupted, the Start/Resume indicator flashes.  NOTE: Push door firmly closed within 4 seconds of touching Start/Resume. If the door is not closed within 4 seconds, the Start/Resume keypad LED will flash, an audible tone will be heard, and the cycle will not start.
<b>Cancel</b> DRAIN	To reset any cycle or options during selection.  To cancel a wash cycle after it has been started	Touch and hold CANCEL/DRAIN to reset any control selections made. See the “Dishwasher Feedback” section in the full User Instructions.
Hi-Temp Wash Sound On/Off Hold 3 Sec	To turn the audible tones on or off.	Touch and hold HI-TEMP WASH for 3 seconds to turn the audible tones on or off. Only audible tones for confirming keypad touches can be turned on/off. Important audible tones, such as indicating a cycle has been interrupted, cannot be deactivated.
	Sani Rinse indicator	If you select the Sani Rinse option, when the cycle is finished, the Sanitized indicator on the control panel glows. If your dishwasher did not properly sanitize your dishes, the Sanitized indicator flashes at the end of the cycle. This can happen if the cycle is interrupted or if water could not be heated to required temperature.  The light goes off when you open and close door or touch CANCEL.

## DISHWASHER CARE

### Cleaning the Exterior

Clean the exterior of the dishwasher with only a soft, damp cloth and mild detergent. If your dishwasher has a stainless steel exterior, it has a coating that is resistant to fingerprints. Avoid using abrasive cleaning products on the exterior of the dishwasher.

### Cleaning and Maintaining the Interior

Many detergents may leave white spots or a white residue on dishware and on the interior of the dishwasher. Over time this residue can become unsightly and could affect dishwasher performance. Use of a dishwasher cleaning product, such as affresh® Dishwasher Cleaner, can help to remove the residue. Monthly use of affresh® Dishwasher Cleaner is recommended to help maintain the dishwasher. Follow package directions.

NOTE: KitchenAid recommends the use of high-quality, premeasured detergent tablets or packs and the use of rinse aid for dishwasher cleaning and daily care.

If you have a drain air gap, check and clean it if the dishwasher isn't draining well.

### **To Reduce Risk of Property Damage During Vacation or Extended Time Without Use:**

- When you will not be using the dishwasher during the summer months, turn off the water and power supply to the dishwasher.
- Make sure the water supply lines are protected against freezing conditions. Ice formations in the supply lines can increase water pressure and cause damage to your dishwasher or home. Damage from freezing is not covered by the warranty.
- When storing your dishwasher in the winter, avoid water damage by having your dishwasher winterized by authorized service personnel.



# TROUBLESHOOTING



IF YOU EXPERIENCE	RECOMMENDED SOLUTIONS
The Clean light is flashing	<p>Check the following:</p> <ul style="list-style-type: none"> <li>• Was the cycle interrupted? Touch START/RESUME and close the door within 4 seconds.</li> <li>• Is the overflow protection float able to move up and down freely? Press down to release.</li> <li>• Be sure the water supply is turned on to the dishwasher. (This is very important following the new installation of your dishwasher.)</li> <li>• Check for suds in the dishwasher. For more information on suds, see “Dishwasher does not clean completely.”</li> </ul>
Dishes do not dry completely	<p>NOTE: Plastic and items with nonstick surfaces are difficult to dry because they have a porous surface which tends to collect water droplets. Towel drying may be necessary.</p> <p>Use of rinse aid along with the Heat Dry or ProDry™ option is needed for proper drying.</p> <p>Proper loading of items can affect drying.</p> <ul style="list-style-type: none"> <li>• For improved results, place items on the more slanted side of the rack.</li> </ul> <p>Glasses and cups with concave bottoms hold water. This water may spill onto other items when you are unloading the dishwasher.</p> <ul style="list-style-type: none"> <li>• Unload the bottom rack first.</li> </ul>



IF YOU EXPERIENCE	RECOMMENDED SOLUTIONS
Spotting/Filming	<p>NOTES:</p> <ul style="list-style-type: none"> <li>• Liquid rinse aid is necessary for drying and to reduce spotting.</li> <li>• Use the correct amount of detergent. If using powder or liquid/gel products, use package instructions.</li> </ul> <p>Confirm that the cloudiness is removable by soaking the item in white vinegar for 5 minutes. If the cloudiness disappears, it is due to hard water. Adjust the amount of detergent and rinse aid. See the “Dishwasher Care” section. If it does not come clear, it is due to etching.</p> <p>Be sure the incoming water temperature is set at 120°F (49°C).</p> <p>Try using the Hi-Temp Wash or Sani Rinse option.</p> <p>To remove spotting, see the “Dishwasher Care” section.</p>
Dishwasher does not clean completely	<p>Be sure the dishwasher is loaded correctly. Improper loading can greatly decrease the washing performance. See the “Operating Your Dishwasher” section.</p> <p>Check filter to ensure it is properly installed. Ensure the water intake screen on the floor of the dishwasher is not plugged with food or debris. Clean if required.</p> <p>Select the proper cycle for the type of soils. The ProWash™ or Tough cycle can be used for tougher loads.</p> <p>Be sure the incoming water temperature is at least 120°F (49°C).</p> <p>Use the proper amount of fresh detergent. More detergent is needed for heavier-soiled loads and hard water conditions.</p> <p>Scrape food from dishes prior to loading (do not prerinse).</p> <p>If foam or suds are detected by the dishwasher sensing system, the dishwasher may not operate properly or may not fill with water.</p> <p>Suds can come from:</p> <ul style="list-style-type: none"> <li>• Using the incorrect type of detergent, such laundry detergent, hand soap, or dish detergent for hand washing dishes.</li> <li>• Not replacing the rinse aid dispenser cap after filling (or refilling) the rinse aid dispenser.</li> <li>• Using an excessive amount of dishwasher detergent.</li> </ul>



**Warning**

This content is compiled from multiple sources and is provided for reference purposes only. It may not be complete or fully applicable to all situations. If you are unable to resolve your issue, please contact the product manufacturer or an authorized service provider for official support.

---

Document generated by [ManualsFile](#)