

Familiarising yourself with your appliance

Familiarise yourself with the parts of your appliance.

Appliance

You can find an overview of the parts of your appliance here.

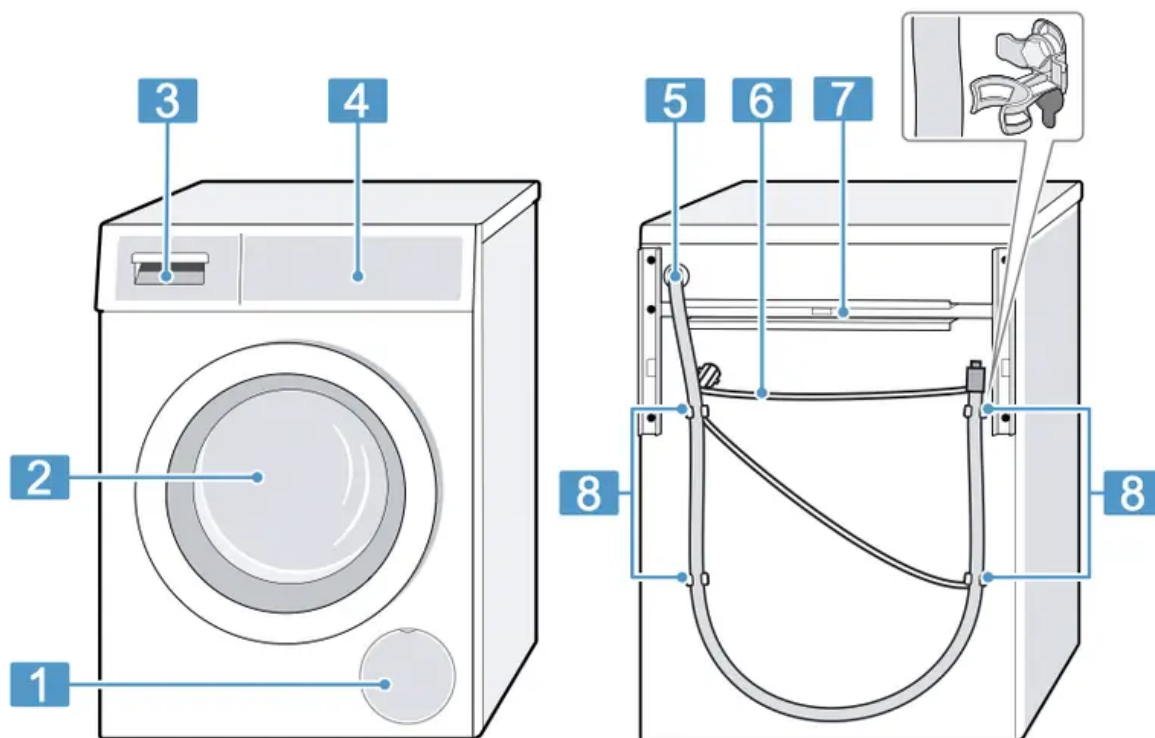

On certain models, specific details such as the colour and shape may differ from those pictured.

1. "Maintenance flap for the drain pump" → Page 42
2. Door
3. "Detergent drawer" → Page 21
4. "Controls" → Page 21
5. "Water outlet hose" → Page 18
6. "Power cord" → Page 18
7. "Transport struts" → Page 16
8. "Transit bolts" → Page 15

Detergent drawer

Below is an overview of the structure of the detergent drawer.

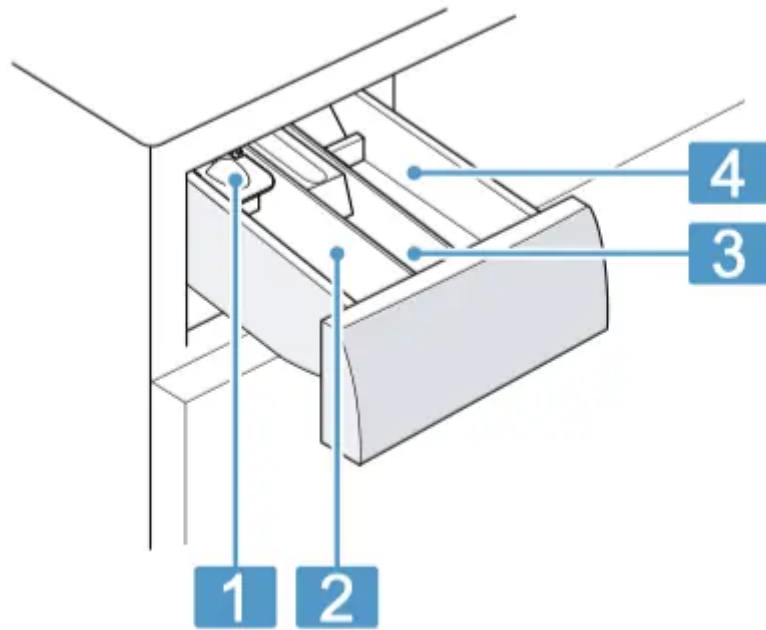

1. Measuring aid for liquid detergent

→ "Using a measuring aid for liquid detergent", Page 36

2. Compartment II:

Detergent for main wash

Water softener

Bleach

Stain remover

3. Compartment :

Fabric softener

Liquid starch

Waterproofing agent

4. Compartment I:

Detergent for prewash

Hygiene detergent

Controls

The controls are used to configure all functions of your appliance and to obtain information about the operating status.

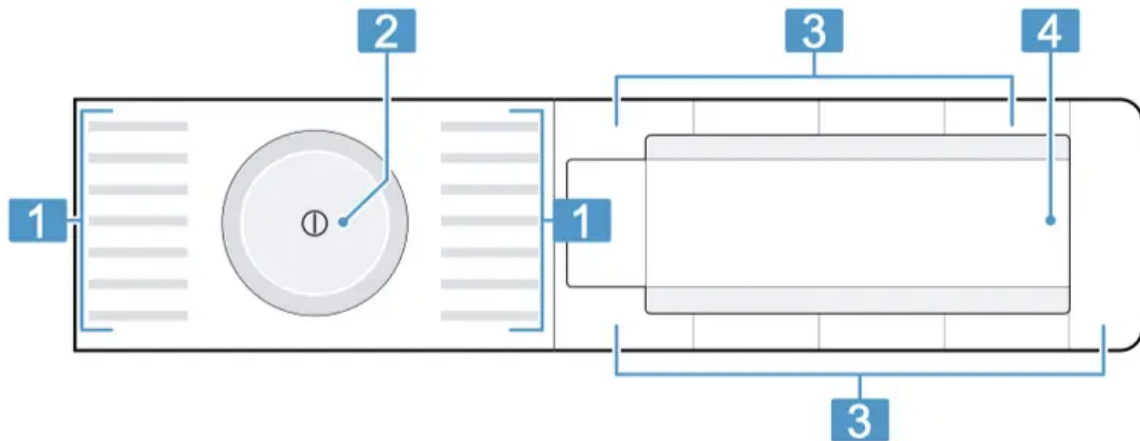







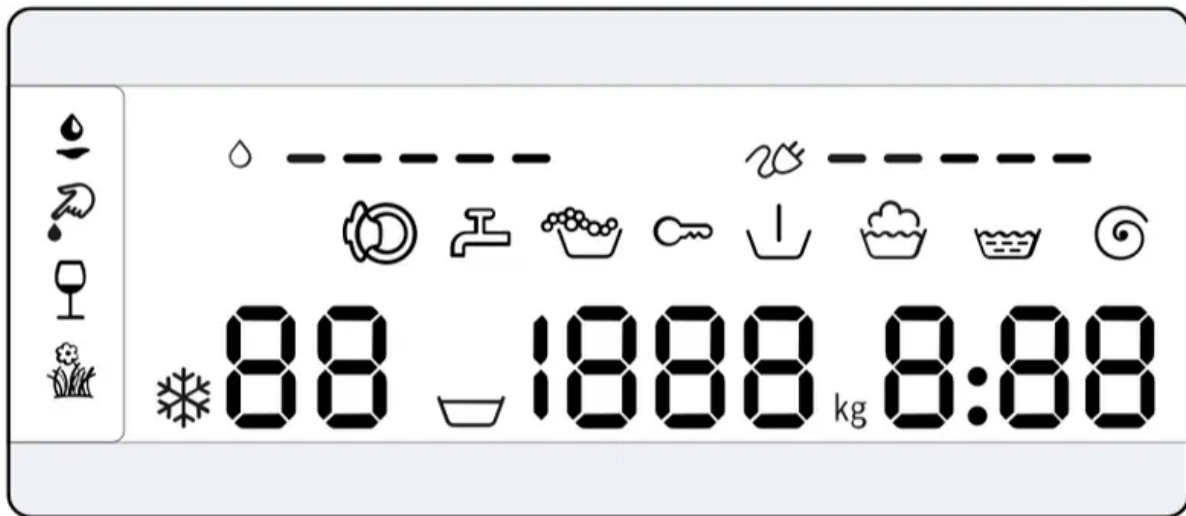











- 1. "Programmes" → Page 26
- 2. "Programme selector" → Page 35
- 3. "Buttons" → Page 24
- 4. "Display" → Page 22

Display

The display shows the current settings, options or relevant information.



















Display	Designation	Description
0:40 ¹	Programme duration/ programme time re- maining	Approximate expected programme duration or pro- gramme time remaining.
10h ¹	"Ready in" time	The programme end has been set and the remaining number of hours is displayed. → "Buttons", Page 24
10 kg ¹	Recommended load	The maximum load capacity for the selected pro- gramme in kg.
 - 1600	Spin speed	Set spin speed in rpm. → "Buttons", Page 24 0= No final spin, only draining  : Rinse Hold, no draining
 - 90	Temperature	Set temperature in °C. → "Buttons", Page 24  (cold)
	Prewash	Programme status
	Wash	Programme status
	Rinse	Programme status
	Spin	Programme status
-P-	Pause	Programme status
¹ Example		

Display	Designation	Description
End	End of programme	Programme status
	Childproof lock	<ul style="list-style-type: none"> ■ Lights up: The childproof lock is activated. ■ Flashes: The childproof lock is active and the programme selector has been adjusted. → "Deactivating the childproof lock", Page 39
	Blood	The stain type is activated.
	Grass	The stain type is activated.
	Red Wine	The stain type is activated.
	Grease and oil	The stain type is activated.
	Energy consumption	Energy consumption for the selected programme. <ul style="list-style-type: none"> ■ — : Low energy consumption ■ ———— : High energy consumption
	Water consumption	Water consumption for the selected programme. <ul style="list-style-type: none"> ■ — : Low water consumption ■ ———— : High water consumption
	Foam detection system	The appliance has detected too much foam. → "Error code / Fault display / Signal", Page 48
	Door	The door is unlocked and can be opened.
	Tap	<ul style="list-style-type: none"> ■ No water pressure. → "Error code / Fault display / Signal", Page 48 ■ The water pressure is too low.
E:60 / -2B ¹	Error	Error code, error display, signal. → "Error code / Fault display / Signal", Page 48
¹ Example		

Buttons

Below is an overview of the buttons and their setting options. The selection of programme settings depends on the selected programme. You can see the selection options for each programme in the overview for → "Programmes", Page 26.

Button	Selection	Description
Start/Reload 	<ul style="list-style-type: none"> • Start • Cancel • Pause 	Start, cancel or pause the programme.
SpeedPerfect 	<ul style="list-style-type: none"> • Activate • Deactivate 	Activate or deactivate a short washing programme. Note: Energy consumption increases. The washing result is not affected by this.
Intensive Plus 	<ul style="list-style-type: none"> • Activate • Deactivate 	Activate or deactivate an extended washing programme. The programme duration is extended by up to 30 minutes. Suitable for heavily soiled laundry.
AntiStain 	Multiple selection	Select the type of stain. The temperature, drum movement and soaking time are all adjusted to suit the type of stain.
- Finished in 	1–24 hours	Set the programme end. The programme duration is already included in the set number of hours. Once the programme has started, the programme duration is displayed.
Temperature 	 - 90 °C	Adjust the temperature in °C.
Spin Speed 	 - 1600	Adjust the spin speed or  activate (Rinse Hold). If  is selected, the water is not drained at the end of the washing cycle and the spin cycle is deactivated. The laundry remains in the water used for rinsing.
	<ul style="list-style-type: none"> • Switch on 	Switch the appliance on or off.













 (mains switch)	<ul style="list-style-type: none"> • Switch off 	
Child Lock  3 sec.	<ul style="list-style-type: none"> • Activate • Deactivate 	<p>Activate or deactivate the childproof lock. Disable the control panel to prevent unwanted or accidental operation.</p> <p>If the childproof lock is activated and the appliance has been switched off, the childproof lock remains activated.</p> <p>→ "Childproof lock", Page 39</p>
Spin Speed 	Basic settings	Change the basic settings for the appliance. → "Changing the basic settings", Page 40
Prewash 	<ul style="list-style-type: none"> • Activate • Deactivate 	Activate or deactivate prewash, e.g. for washing heavily soiled laundry.
Rinse Plus 	<ul style="list-style-type: none"> • Activate • Deactivate 	Activate or deactivate an additional rinse cycle. Recommended for particularly sensitive skin or in regions with very soft water.
Easy Iron 	<ul style="list-style-type: none"> • Activate • Deactivate 	<p>Activate or deactivate the reduced creasing programme.</p> <p>In order to reduce creasing in the laundry, the spin cycle and the spin speed are adapted.</p> <p>The laundry is damp enough after washing that it needs to be hung out on a washing line.</p>

Programmes













Programmes

Below is an overview of the programmes. You can find information on the load and on the adjustable programme options.

Tip: The laundry's care labels provide you with additional information on programme selection.
→ "Care symbols on the care labels", Page 33

Programme	Description	Max. load (kg)	Max. temperature (°C) ¹	Max. spin speed (rpm) ¹	SpeedPerfect 	AntiStain 	Rinse Plus 	Spin Speed  (Rinse Hold) 	Prewash 	Easy Iron 	Intensive Plus 
Cottons 	Wash hard-wearing items made from cotton, linen or blended fabrics. Also suitable as a short programme for normally soiled laundry when you activate SpeedPerfect  . If SpeedPerfect  is activated, the maximum load capacity is reduced to 5 kg.	10	90	1600	●	●	●	●	●	●	●
Cotton Eco 	Wash hard-wearing items made from cotton, linen or blended fabrics. Energy-saving programme. Note: To save energy, the actual washing temperature may deviate from the set washing temperature. The washing performance meets legal requirements.	10	90	1600	-	●	●	●	●	●	-

¹ Programme setting

Programme	Description	Max. load (kg)	Max. temperature (°C) ¹	Max. spin speed (rpm) ¹	SpeedPerfect 	AntiStain 	Rinse Plus 	Spin Speed  (Rinse Hold) 	Prewash 	Easy Iron 	Intensive Plus 
Easy Care 	Wash items made from synthetic or blended fabrics.	4	60	1200	●	●	●	●	●	●	●
Quick Mixed 	Wash items made from cotton, linen, or synthetic or blended fabrics. Suitable for lightly soiled laundry.	4	60	1600	●	●	●	●	●	●	●
Delicates/Silk 	Wash delicate, washable items made from silk, viscose and synthetics. Use a detergent that is suitable for delicates or silk. Note: Wash especially delicate items or items with hooks, eyelets or clips in a mesh laundry bag.	2	40	800	-	●	●	●	●	●	-
Wool 	Hand- or machine-washable items that are made from wool or contain wool. To prevent the laundry from shrinking, the drum moves the items very gently with long pauses. Use a detergent that is suitable for wool.	2	40	800	-	-	-	●	-	-	-
Rinse 	Rinses and then spins the laundry, and then drains the water.	-	-	1600	-	-	●	●	-	●	-













¹ Programme setting

Programme	Description	Max. load (kg)	Max. temperature (°C) ¹	Max. spin speed (rpm) ¹	SpeedPerfect =	AntiStain	Rinse Plus	Spin Speed (Rinse Hold)	Prewash	Easy Iron	Intensive Plus
Spin/Drain	Spins and drains the water. If you only want to drain the water, activate 0. The laundry is not spun.	-	-	1600	-	-	-	-	-	•	•
Drum Clean	Cleaning and caring for the drum. Use this programme in the following cases: <ul style="list-style-type: none"> Before using the appliance for the first time If you regularly wash at temperatures of 40 °C or lower After a prolonged period of non-use Use washing powder or a detergent containing bleach. Halve the amount of detergent to avoid foaming. Do not use fabric softener. Do not use liquid detergent or detergent that is intended for woollens or delicates. <p>Note: The drum cleaning indicator will flash to remind you if you have not used a programme at 60 °C or higher for a long time.</p>	-	-	1200	-	-	-	-	-	-	

¹ Programme setting

Programme	Description	Max. load (kg)	Max. temperature (°C) ¹	Max. spin speed (rpm) ¹	SpeedPerfect =	AntiStain	Rinse Plus	Spin Speed (Rinse Hold)	Prewash	Easy Iron	Intensive Plus
Night Wash	Wash items made from cotton, linen, or synthetic or blended fabrics. Suitable for quiet washing at night. The audible signal at the end of the programme is deactivated and a reduced final spin speed set by default.	4	60	1600	•	•	•	•	•	•	•
AllergyPlus	Wash hard-wearing items made from cotton, linen or blended fabrics. Suitable for allergy sufferers and for strict hygiene requirements. <p>Note: Once the set temperature has been reached, it remains constant throughout the washing process.</p>	6,5	60	1600	•	•	•	•	•	•	•
Shirts/Blouses	Wash non-iron shirts and blouses made from cotton, linen, synthetic fibres or blended fabrics. <p>Tip: In order to avoid creasing in your laundry, you can activate Easy Iron. The laundry is only given a short spin and can be removed while still dripping wet. Hang out shirts and blouses while they are still dripping wet so that they drip dry.</p>	2	60	800	-	•	•	•	•	•	•

¹ Programme setting

Programme	Description	Max. load (kg)	Max. temperature (°C) ¹	Max. spin speed (rpm) ¹	SpeedPerfect 	AntiStain 	Rinse Plus 	Spin Speed  (Rinse Hold)	Prewash 	Easy Iron 	Intensive Plus 
	Use the Delicates/Silk  programme to wash shirts and blouses made from silk or delicate fabrics.										
 Sportswear	Wash sports and leisure items made from synthetic fibres, microfibre or fleece. Use a detergent that is suitable for sports items. Do not use fabric softener. Tip: Use the Easy Care  programme to wash heavily soiled laundry.	2	40	800	-	•	•	•	•	•	•
 Super 15/30'	Wash items made from cotton, synthetic or blended fabrics. Short programme for small items of lightly soiled laundry. The programme duration is approx. 30 minutes. If you wish to reduce the programme duration to 15 minutes, activate SpeedPerfect  . The maximum load is reduced to 2 kg.	4	40	1200	•	-	•	•	-	-	-

¹ Programme setting

Before using for the first time

Prepare the appliance for use.

Starting an empty washing cycle

Your appliance was inspected thoroughly before leaving the factory. To remove any residual water, run the first wash cycle without any laundry.

Note: Please read the information in the "Safety" → Page 4 and "Preventing material damage" → Page 11 sections to ensure that you use the appliance safely.

1. Press 

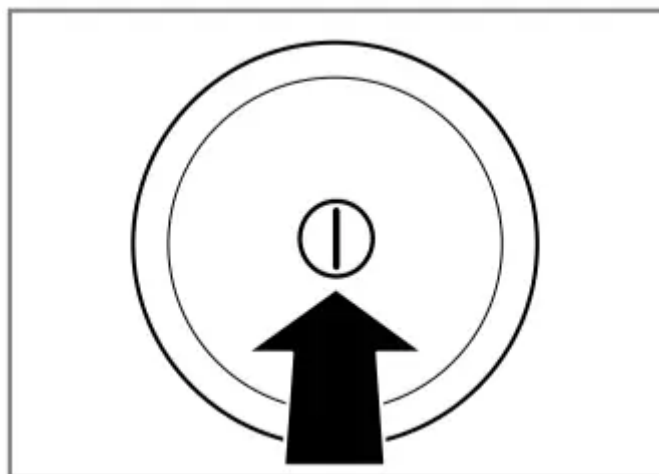

It may take a few seconds for the appliance to switch on.

2. Set the  Drum Clean programme.
3. Close the door.
4. Pull out the detergent drawer.

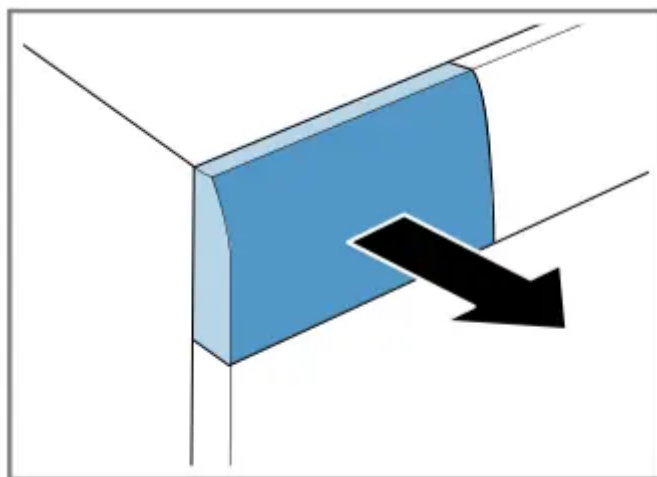

5. Pour approx. 1 litre of tap water into compartment II.

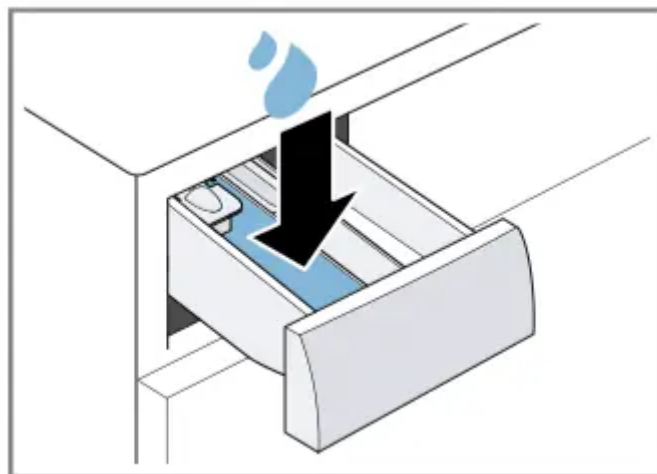

6. Pour washing powder into compartment II.

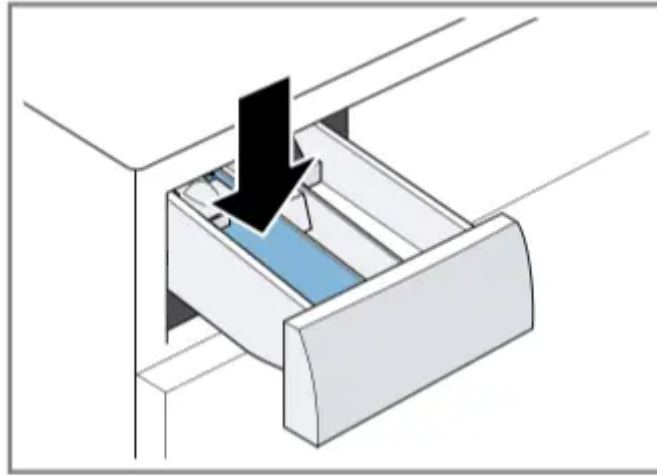

To prevent foaming, use only half of the amount of detergent recommended by the detergent manufacturer for light soiling. Do not use detergent suitable for woollens or delicates.

7. Push in the detergent drawer.

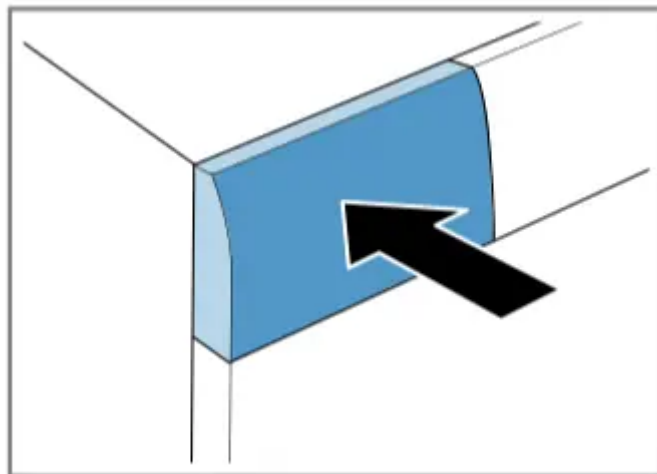

8. Press Start/Reload to start the programme.

✓ The display shows the remaining programme duration.

✓ After the programme has ended, the display shows: End.

9. Start the first wash cycle or press  to switch off the appliance.

→ "Basic operation", Page 35

Laundry

You can wash all items that the manufacturer has marked as machine-washable on the care label and fabrics made from hand-washable wool using your appliance.

Preparing the laundry

ATTENTION!

Objects remaining in the laundry may damage the laundry and the drum.

- ▶ Remove all items from any pockets in your laundry before using the appliance.
- ▶ To protect your appliance and the laundry, prepare the laundry beforehand.
 - Empty all pockets
 - Brush sand out of all collars and pockets
 - Close bed covers and cushion covers
 - Close all zips, Velcro fasteners, hooks and eyes
 - Tie cloth belts and apron strings together or use a mesh laundry bag
 - Remove curtain hooks and lead strips or use a mesh laundry bag
 - Use a mesh laundry bag for small items of laundry such as children's socks
 - Separate items of laundry and shake them out
 - Wash large and small items of laundry together
 - Dab fresh stains with soapy water (do not rub them)
 - Some stubborn or dried-in stains can be removed by washing several times

Sorting laundry

Note: Please read the information in the "Safety" → Page 4 and "Preventing material damage" → Page 11 sections to ensure that you use the appliance safely.





- ▶ To improve washing results and prevent discolouration, sort the laundry according to the following criteria before washing.
 - Type of fabric and fibre type
 - Whites
 - Colours Wash new coloured items separately the first time you wash them.
 - "Soiling" → Page 33
 - "Care symbols on the care labels" → Page 33

Degrees of soiling

Degree of soiling	Soiling	Examples
Light	<ul style="list-style-type: none"> No dirt or stains are visible Laundry has absorbed odours 	Light summer clothing or sports clothing that has been worn for a just a few hours
Normal	Dirt or light stains are visible	<ul style="list-style-type: none"> T-shirts, shirts or blouses are sweat-soaked or have been worn a few times Towels or bedding that has been used for up to one week
Heavy	Dirt or stains are clearly visible	Tea towels, baby items or work clothing

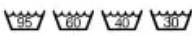
Care symbols on the care labels

The symbols indicate the recommended programme and the numbers in the symbols indicate the maximum recommended washing temperature.

Symbol	Washing process	Recommended programme
	Normal	Cottons
	Gentle	Easy Care
	Particularly gentle	Delicates/Silk for washing by hand
	Hand wash	Wool
	Not suitable for machine-washing	-

Tip: You can find more information about care symbols at www.ginetex.ch.

Detergents and care products

You can protect your appliance and your laundry by selecting and using the correct detergents and care products. You can use all detergents and care products which are suitable for domestic washing machines.

Note: Please read the information in the "Safety" → Page 4 and "Preventing material damage" → Page 11 sections to ensure that you use the appliance safely.

The manufacturer's instructions for use and dosage can be found on the packaging.

Notes

- Only use liquid detergents that are self-flowing
- Do not mix different liquid detergents
- Do not mix detergent and fabric softener
- Do not use products which have developed a top layer or are highly congealed
- Do not use products containing solvents, caustic agents or volatile substances (e.g. bleach)
- Use dyes sparingly as salt may damage stainless steel
- Do not use bleaching agents in the appliance

Detergent recommendation

This information helps you to choose the right detergent for your fabrics.

Detergent	Fabrics	Programme	Temperature
Standard detergent with optical brighteners	Heat-resistant white fabrics made from cotton or linen	Cottons	From cold up to 90 °C
Detergent for colours without bleach or optical brighteners	Coloured fabrics made from linen or cotton	Cottons	From cold up to 60 °C
Detergent for colours/ delicates without optical brighteners	Coloured fabrics made from easy-care fibres or synthetic materials	Easy Care	From cold up to 60 °C
Detergent for delicates	Delicate fabrics made from silk or viscose	Delicates/ Silk	From cold up to 40 °C
Detergent for woollens	Wool	Wool	From cold up to 40 °C

Tip: Visit [cleanright](#) to find further information on detergents, care products and cleaning agents for domestic use.

Detergent dosage

Use the correct detergent dosage to achieve optimal washing results and save resources.

The detergent dosage depends on:

- The amount of laundry
- Degree of soiling

- Water hardness

You can find out how hard your water is from your local water company or measure it yourself using a water hardness tester.

Water hardness

Hardness range	Total hardness in mmol/l	German degrees in °dH
soft (I)	0-1.5	0-8.4
medium (II)	1.5- 2.5	8.4-14
hard (III)	over 2.5	over 14

Example of a manufacturer's instructions for detergent

These example values refer to a standard load of 4–5 kg.

Soiling	Light	Normal	Heavy
Water hardness: Soft/medium	40 ml	55 ml	80 ml
Water hardness: Hard/very hard	55 ml	80 ml	105 ml

The dosages can be found on the manufacturer's packaging.

- Adjust the dosage to the actual load.

Basic operation

You can find out everything you need to know about operating your appliance here.

Switching on the appliance

► Press 

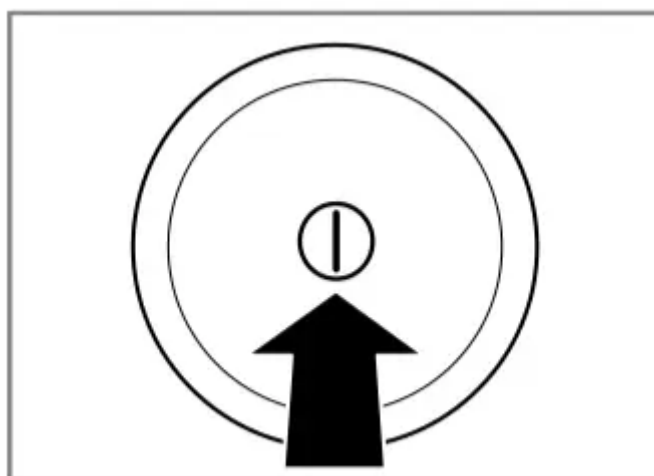

It may take a few seconds for the appliance to switch on.

Note: The drum is lit up after the door is opened and closed and once the programme has started. The light goes out automatically.

Setting a programme

1. Set the programme selector to the required "programme" → Page 26.

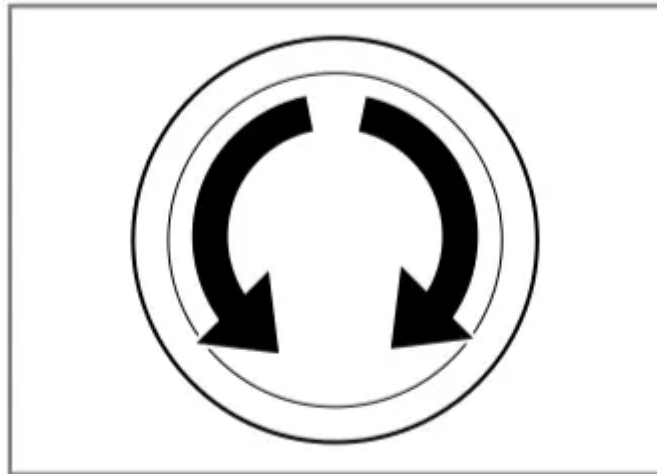

2. If necessary, "adjust the programme settings" → Page 36.

Adjusting the programme settings

Depending on the programme and programme progress, you can adjust or activate/deactivate the settings.

Note: Overview of all programme settings:

→ "Buttons", Page 24

Requirement: A programme has been set.

► Adjust the programme settings. The programme settings are not saved permanently for the programme.

Loading laundry

Notes

- Please read the information in the "Safety" → Page 4 and "Preventing material damage" → Page 11 sections to ensure that you use the appliance safely.
- To prevent creasing, take note of the maximum load for the relevant "programme" → Page 26.

Requirement: Prepare and sort the laundry.

→ "Laundry", Page 32

1. Open the door.

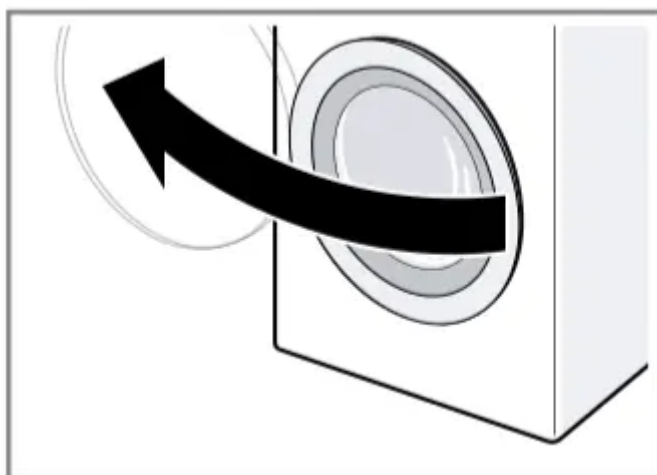

2. Ensure that the drum is empty.
 3. Separate the laundry and place it in the drum.
 4. **Note:** Ensure that there is no laundry trapped in the door.
- Close the door.

Using a measuring aid for liquid detergent

If you order the measuring aid as an accessory, you must use the measuring aid.

1. Pull out the detergent drawer.

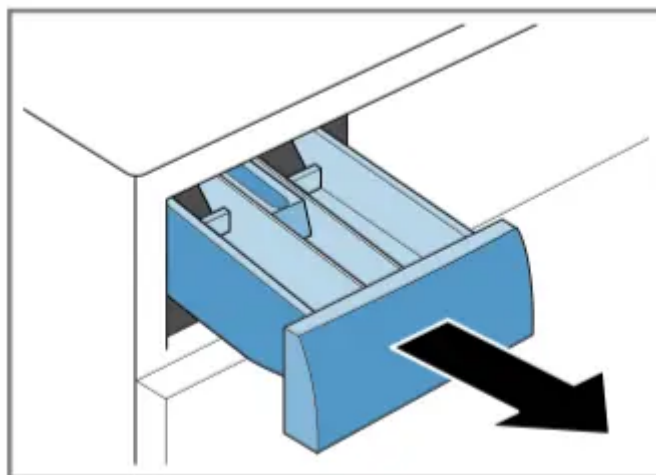

2. Press down on the insert and remove the detergent drawer.

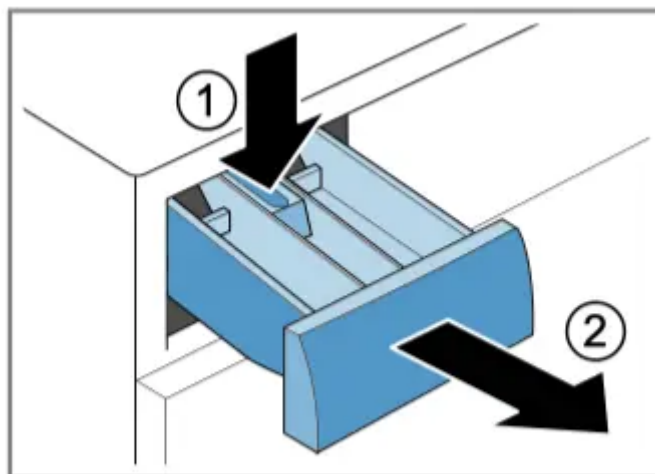

3. Insert the measuring aid.

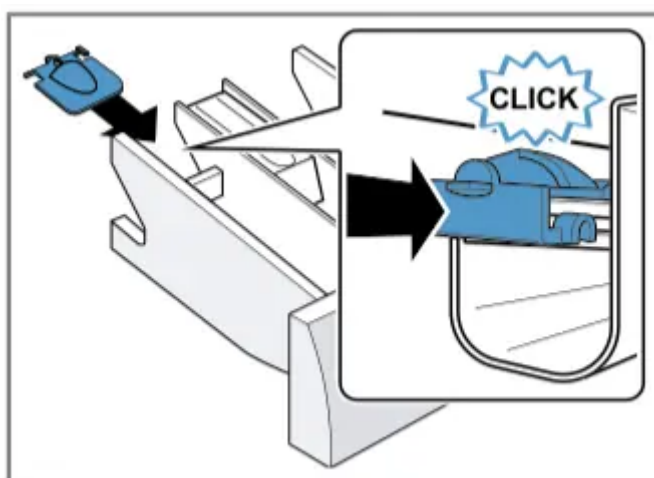

4. Insert the detergent drawer.

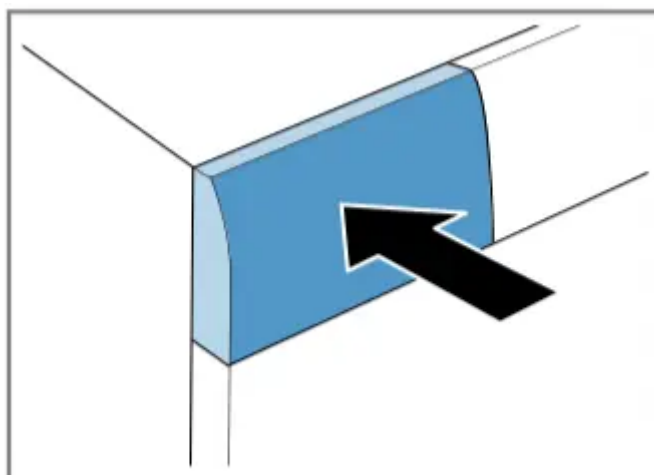

Use the measuring aid for liquid detergent

To add liquid detergent, you can use a measuring aid in the detergent drawer.

1. Pull out the detergent drawer.

2. Slide the measuring aid forwards.

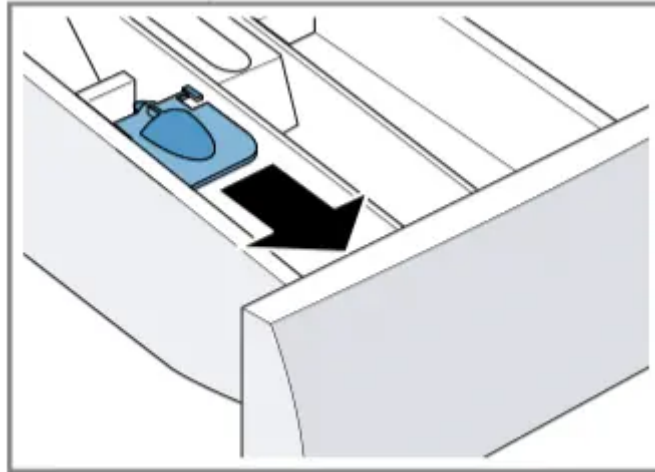

3. Fold the measuring aid down and click it into place.

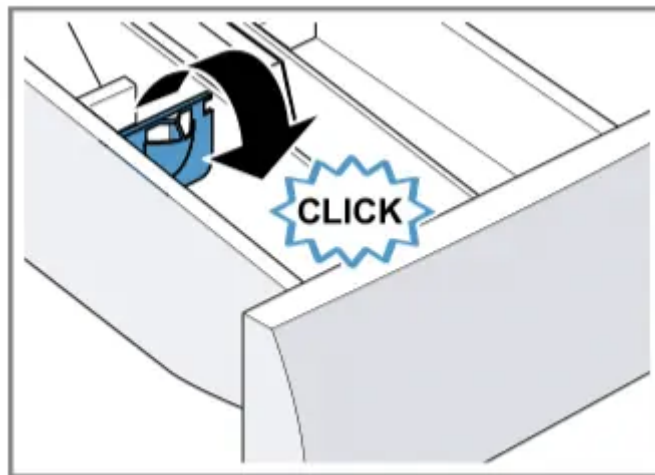

4. Push in the detergent drawer.

Adding detergent and care product

Notes

- Please read the information in the "Safety" → Page 4 and "Preventing material damage" → Page 11 sections to ensure that you use the appliance safely.
- Do not use the measuring aid for liquid detergent for gel detergents, washing powder, or if Prewash or "Ready in" time are activated.

Requirement: Find out the optimum dosage for "detergent and care product." → Page 34

1. Pull out the detergent drawer.
2. Pour in detergent. → "Detergent drawer", Page 21
3. If required, add the care product.
4. Push in the detergent drawer.

Starting the programme

Note: If you want to change the time until the programme ends, set the "Ready in" time first.

▶ Press Start/Reload .

√ The drum rotates and load detection takes place. This can take up to 2 minutes, after which water enters the drum.

√ The display shows either the programme duration or the "Ready in" time.

√ After the programme has ended, the display shows: End.

Soaking laundry

You can soak the laundry before washing in the appliance by pausing the programme.

Note: No additional detergent is required. The washing solution is then used for washing.

1. Start the programme.

2. To pause the programme, after approx. 10 minutes, press Start/Reload .

3. To resume the programme, after the desired soaking time, press Start/Reload .

Adding laundry

Note: Please read the information in the "Safety" → Page 4 and "Preventing material damage" → Page 11 sections to ensure that you use the appliance safely.

1. Press Start/Reload . The appliance is paused and checks whether it is possible to add or remove laundry. Take note of the programme status.

2. Add or remove laundry.

3. Close the door.

4. Press Start/Reload .

Cancelling the programme

Once the programme has started, you can cancel it at any time.

Note: Please read the information in the "Safety" → Page 4 and "Preventing material damage" → Page 11 sections to ensure that you use the appliance safely.

1. Press Start/Reload .

2. Open the door.

The appliance door remains locked for safety reasons if the temperature and water levels are high.

– If the temperature is high, start the Rinse  programme.

– If the water level is high: Start the Spin  or  Drain programme.

3. Remove the laundry.

Resuming the programme when the programme status is Rinse Hold

1. Set the  Spin or  Drain programme.

2. Press Start/Reload .

Unloading the laundry

Note: Please read the information in the "Safety" → Page 4 and "Preventing material damage" → Page 11 sections to ensure that you use the appliance safely.

1. Open the door.

2. Remove the laundry.

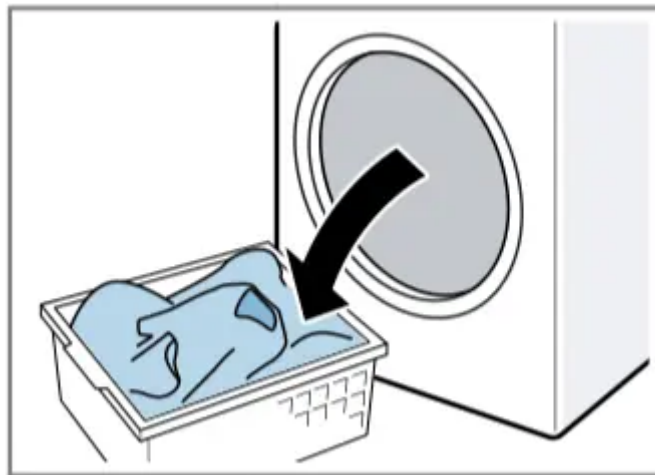

Switching off the appliance

1. Press .

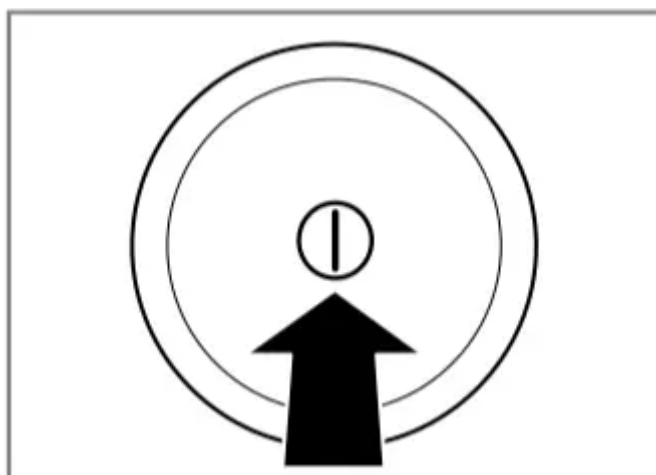

2. Turn off the tap.

3. Wipe the rubber gasket dry and remove any foreign objects.

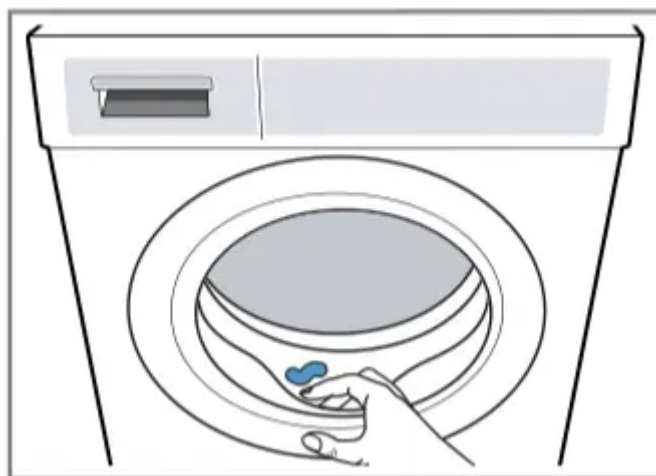

4. Leave the door and detergent drawer open so that residual water can evaporate.

Childproof lock

Secure your appliance against being operated unintentionally using the controls.

Activating the childproof lock

► Press and hold the two Child Lock  3 sec. buttons for approx. 3 seconds.

✓ The display shows .

✓ The controls are locked.

✓ The childproof lock remains active even after the appliance has been switched off.

Deactivating the childproof lock

Requirement: To deactivate the childproof lock, the appliance must be switched on.

► Press and hold the two Child Lock  3 sec. buttons for approx. 3 seconds.

So that the programme currently running is not cancelled, the programme selector must be set to the initial programme.

√  goes out in the display.

Basic settings

You can configure the appliance to meet your needs.

Overview of basic settings

Below is an overview of the basic settings on your appliance.

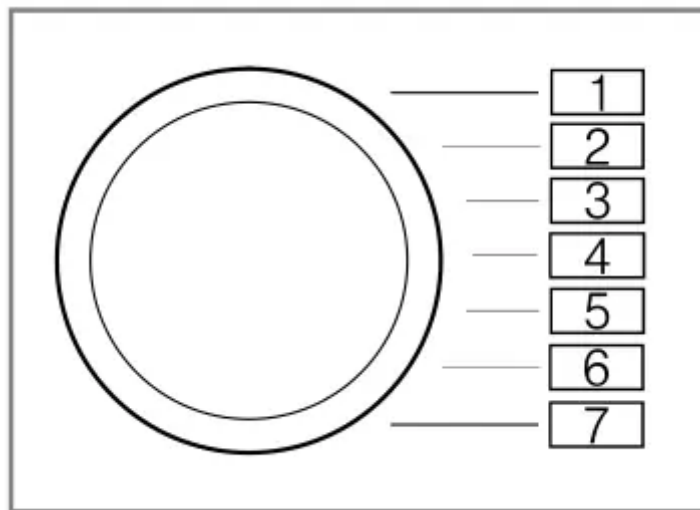

Basic setting	Programme position	Value	Description
End signal	2	0 (off) 1 (quiet) 2 (medium) 3 (loud) 4 (very loud)	Set the volume of the signal at the end of the programme.
Button signal	3	0 (off) 1 (quiet) 2 (medium) 3 (loud) 4 (very loud)	The volume of the audible signal emitted when the buttons are pressed.
Drum cleaning reminder	4	ON OFF	Activate or deactivate the reminder to clean the drum.

Changing the basic settings

1. Set the programme selector to position 1.

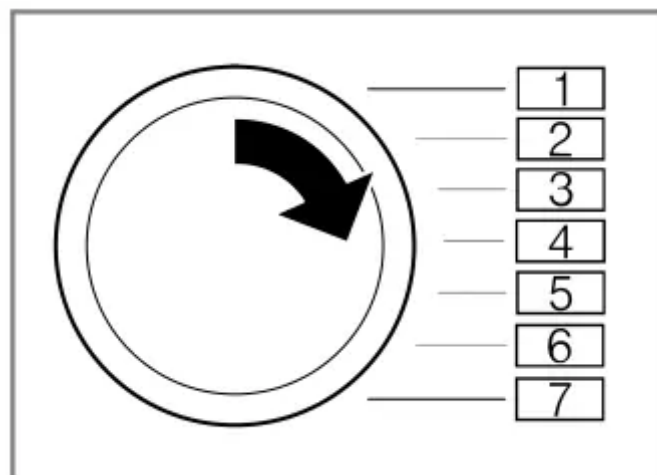

2. Press Spin Speed  and, at the same time, turn the programme selector to position 2.

√ The display shows the current value.

3. Set the programme selector to the required position.

4. To change the value, press - / +.

5. To save the changes, switch off the appliance.

Cleaning and servicing

To keep your appliance working efficiently for a long time, it is important to clean and maintain it carefully.

Tips on appliance care

Follow the tips for appliance care to ensure your appliance works correctly in the long term.

Wipe down the housing and the control panel with nothing but water and a damp cloth.	The appliance parts remain clean and hygienic.
Remove all detergent residue, spray residue or other residues immediately.	Fresh deposits are easier to remove without leaving any residue.
Keep the appliance door and detergent drawer open after use.	This allows the residual water to dry, reducing odours in the appliance.

Cleaning the drum

If you often wash at a washing temperature of 40 °C and lower or the appliance has not been used for a long period, clean the drum.

CAUTION Risk of injury!

Permanently washing at low temperatures and a lack of ventilation for the appliance may damage the drum and cause injury.

- ▶ Regularly run a programme for cleaning the drum or wash at temperatures of at least 60 °C.
- ▶ Leave the appliance to dry after every operation with the door open, and leave the detergent drawer to dry.
- ▶ Run the  Drum Clean programme without laundry. Add washing powder.

Cleaning the detergent drawer

Note: Please read the information in the "Safety" → Page 4 and "Preventing material damage" → Page 11 sections to ensure that you use the appliance safely.

1. Pull out the detergent drawer.
2. Press down on the insert and remove the detergent drawer.

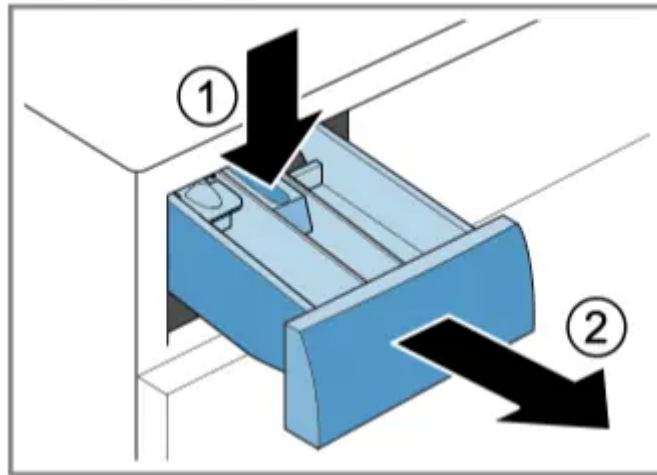

3. Press out the insert upwards from below.

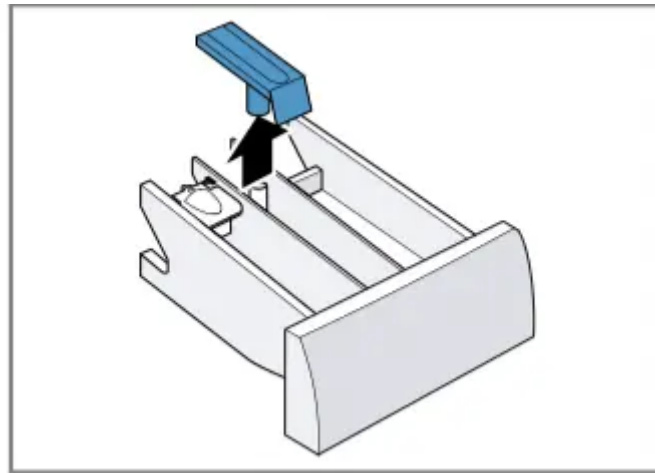

4. Clean the detergent drawer and insert with water and a brush, and then dry them.

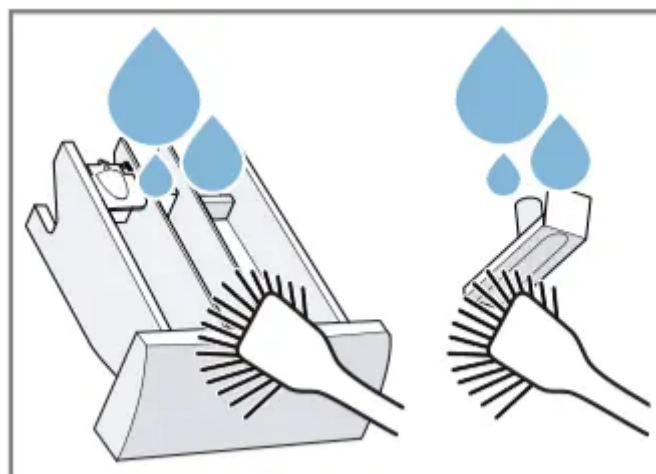

5. Fit the insert and lock it into place.

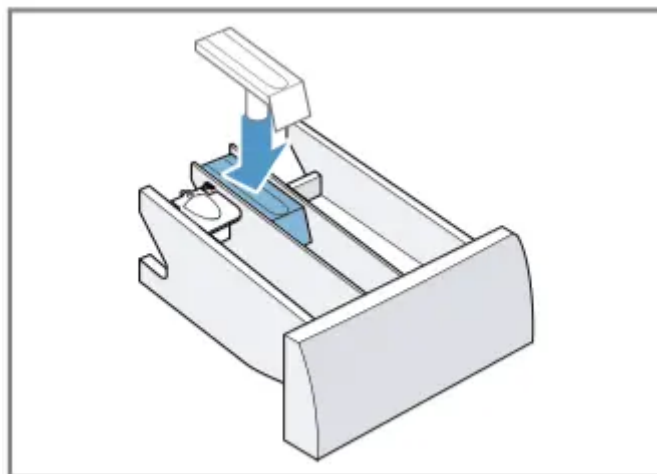

6. Cleaning the opening for the detergent drawer.



7. Push in the detergent drawer.

Descaling

If you add detergent correctly, you do not need to descale your appliance. If you still wish to use descaler, follow the manufacturer's instructions for use.

ATTENTION!

The use of unsuitable descaling agents, e.g. for coffee machines, may damage the appliance.

- For this appliance, only use descaling agents that are available from the manufacturer's website or our after-sales service.

Cleaning the drain pump

Clean the drain pump in the event of faults, e.g. blockages or rattling noises.

Emptying the drain pump

Note: Please read the information in the "Safety" → Page 4 and "Preventing material damage" → Page 11 sections to ensure that you use the appliance safely.

1. Turn off the water tap.
2. Switch off the device.
3. Disconnect the appliance's mains plug from the power supply.
4. Open the maintenance flap.

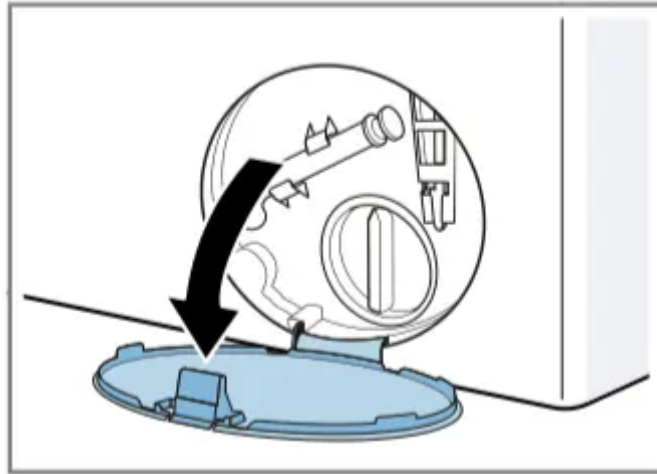

5. Remove the maintenance flap.

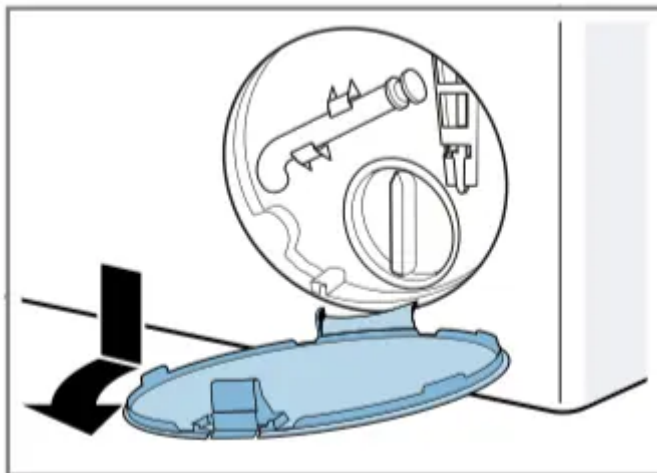

6. Slide a receptacle under the opening.

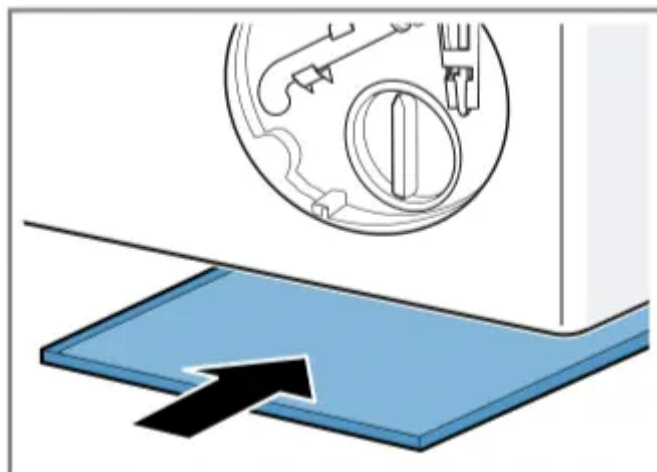

7. Take the drain hose out of the holder.



8. CAUTION - Risk of scalding!

When you wash at high temperatures, the detergent solution gets hot.

► Do not touch the hot detergent solution.

To allow the detergent solution to flow out into the container, remove the sealing cap.

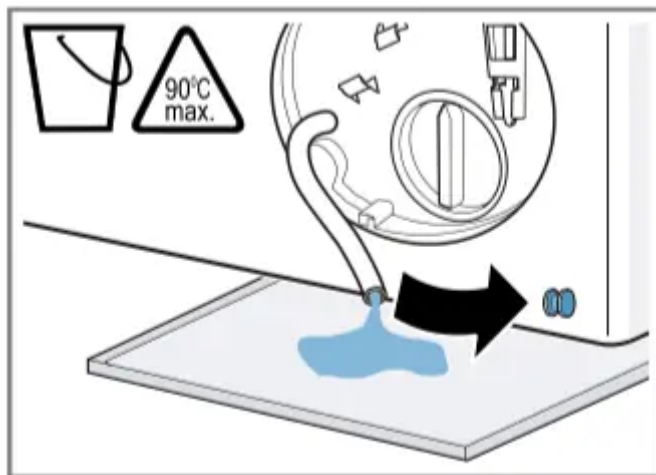

9. Firmly press on the sealing cap.

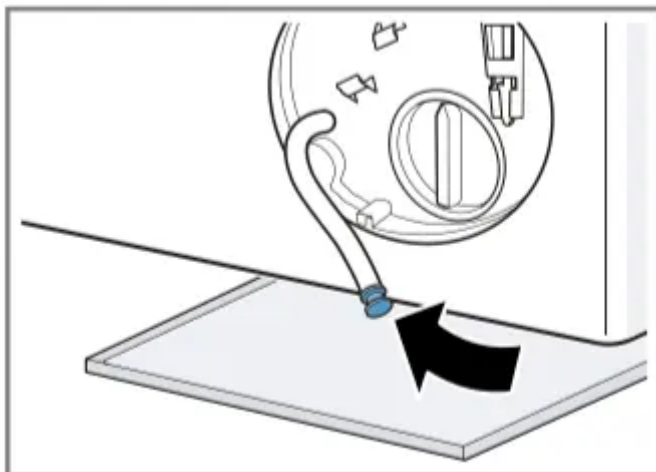

10. Insert the drain hose into the holder.

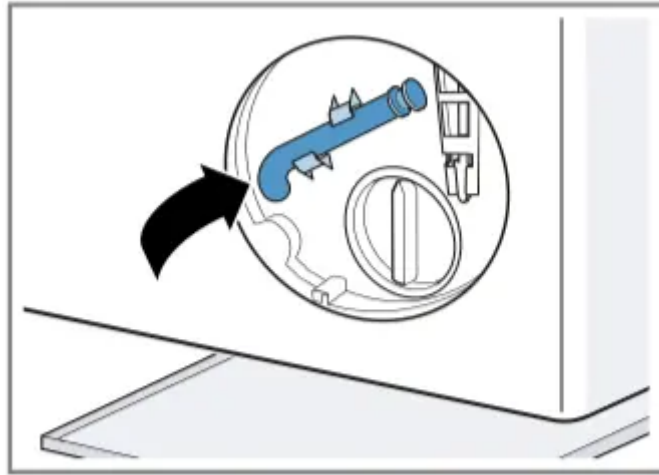

Cleaning the drain pump

Note: Please read the information in the "Safety" → Page 4 and "Preventing material damage" → Page 11 sections to ensure that you use the appliance safely.

Requirement: "The drain pump is empty." → Page 42

1. Since water may remain in the drain pump, remove the pump cap carefully.
 - The filter insert in the pump housing may become stuck due to coarse particles of dirt. Loosen the dirt and remove the filter insert.

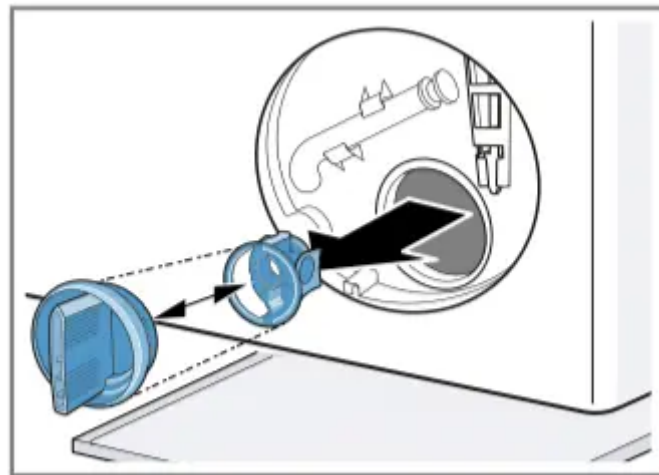

2. Clean the interior, the thread on the pump cap and the pump housing.

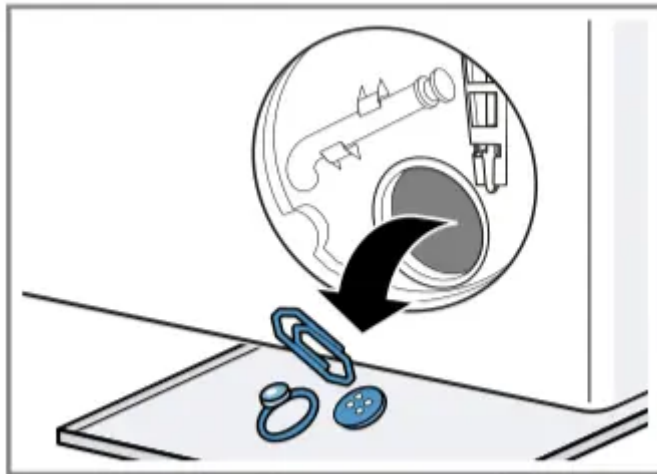

The pump cap is comprised of two parts which can be taken apart for cleaning.

3. Make sure that the impeller in the drain pump can be rotated.
4. Insert the pump cap.
 - Ensure that the parts of the pump cap are correctly assembled.

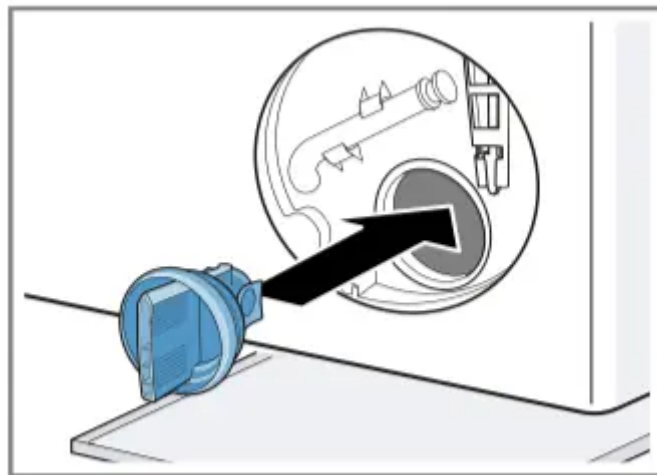

5. Screw on the pump cap.

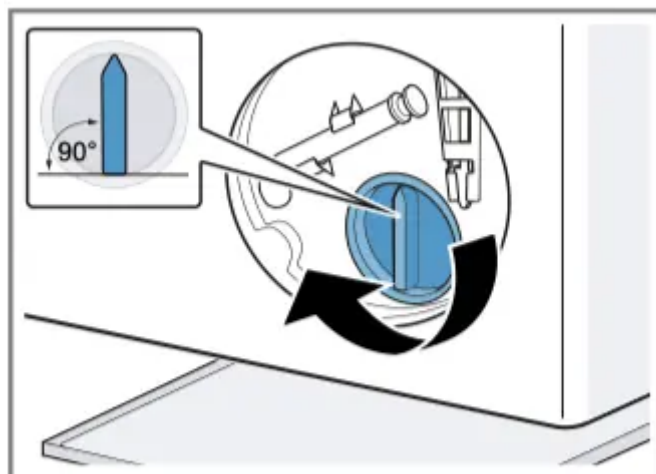

The handle on the pump cap must be in a vertical position.

6. Insert the maintenance flap and lock it into place.

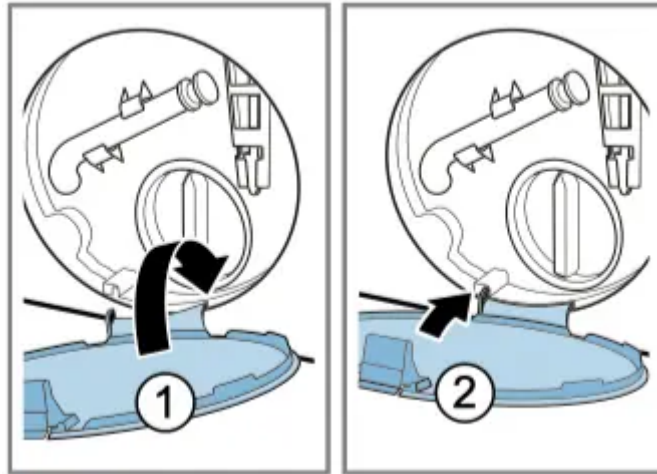

7. Close the maintenance flap.

Before the next wash

To prevent unused detergent from flowing straight into the outlet in the next wash, run the Drain programme after you have emptied the drain pump. 

1. Turn on the tap.
2. Insert the mains plug.
3. Switch on the appliance.
4. Pour 1 litre of water into compartment II.
5. Start the  Drain programme.

Cleaning the water outlet hose at the siphon

If the water outlet hose at the siphon is dirty or the detergent solution is not being pumped out, you must clean these.

1. Switch off the appliance.
2. Disconnect the appliance's mains plug from the power supply.
3. Loosen the hose clamp and carefully remove the water outlet hose.

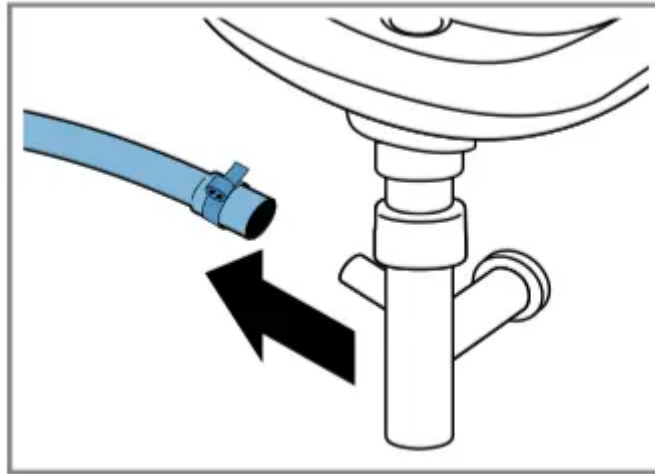

Residual water may leak out.

4. Clean the water outlet hose and siphon connecting piece.

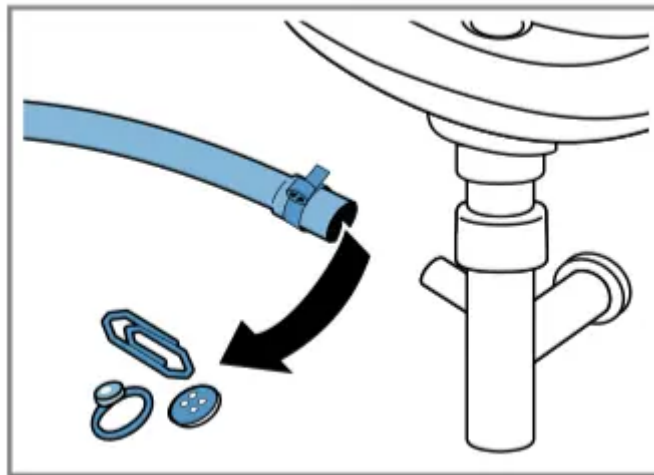

5. Reattach the water outlet hose and secure the connection point using the hose clamp.

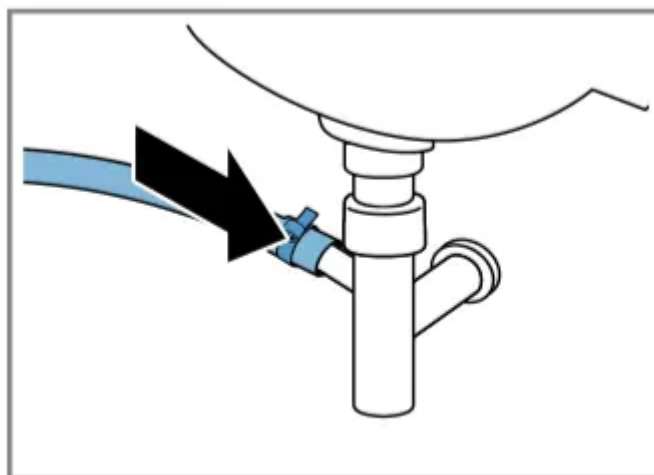



Clean the water inlet filters.

Clean the filters in the water inlet in the event of blockages or if the water pressure is too low.

Emptying the water inlet hose

In order to be able to clean the filters, you must first empty the water inlet hose.

1. Turn off the tap.
2. Set a programme, except for  Rinse ,  Spin or  Drain.
3. Start the programme and leave it to run for approx. 40 seconds.
4. Switch off the appliance.
5. Disconnect the appliance's mains plug from the power supply.

Cleaning the filter on the tap

Note: Please read the information in the "Safety" → Page 4 and "Preventing material damage" → Page 11 sections to ensure that you use the appliance safely.

Requirement: The water inlet hose is empty.

1. Remove the water inlet hose from the tap.

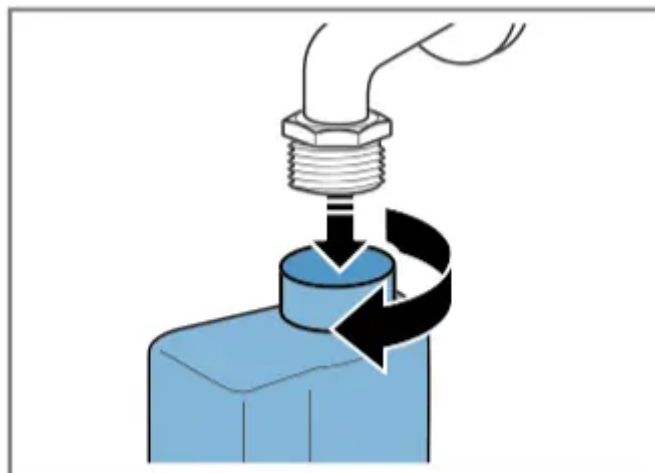

2. Clean the filter with a small brush.

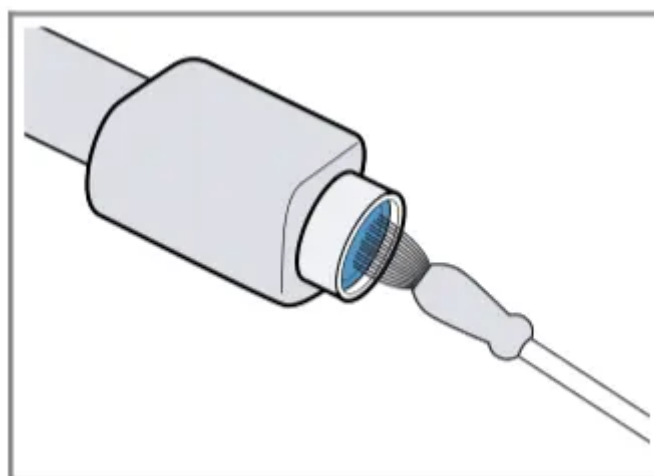

3. Connect the water inlet hose and check for leaks.

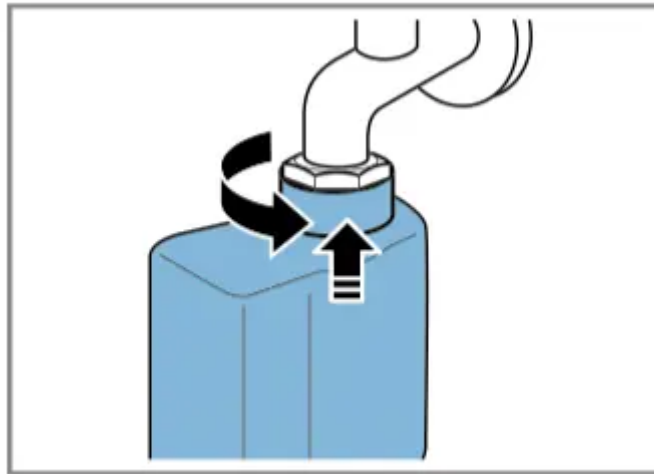

Cleaning the filter on the appliance

Note: Please read the information in the "Safety" → Page 4 and "Preventing material damage" → Page 11 sections to ensure that you use the appliance safely.

Requirement: The water inlet hose is empty.

→ "Emptying the water inlet hose", Page 46

1. Disconnect the hose from the rear of the appliance.

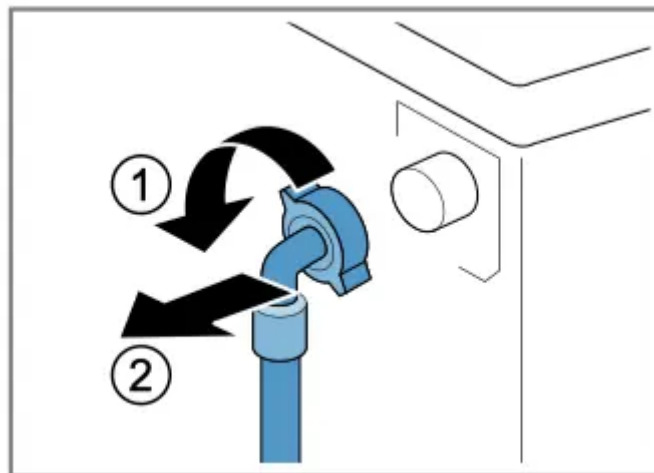

2. Use pliers to remove the filter.

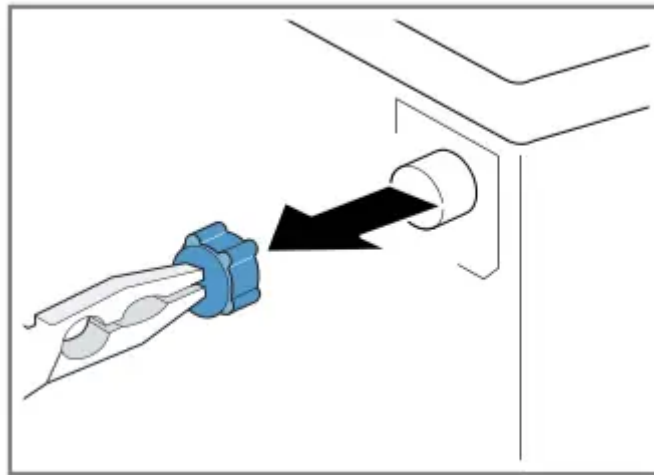

3. Clean the filter with a small brush.

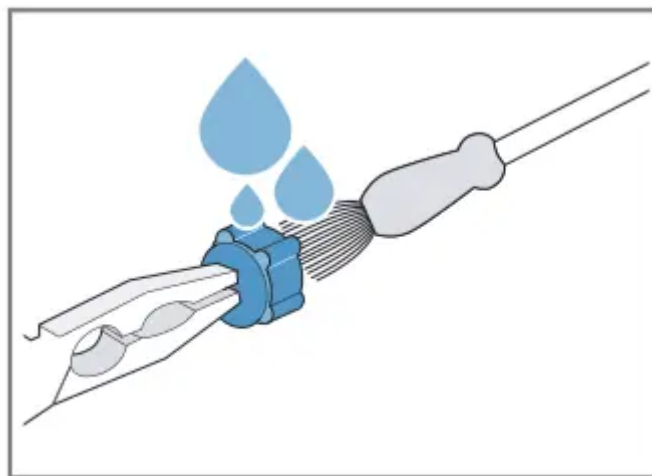

4. Reinsert the filter.

5. Connect the hose and check for leaks.

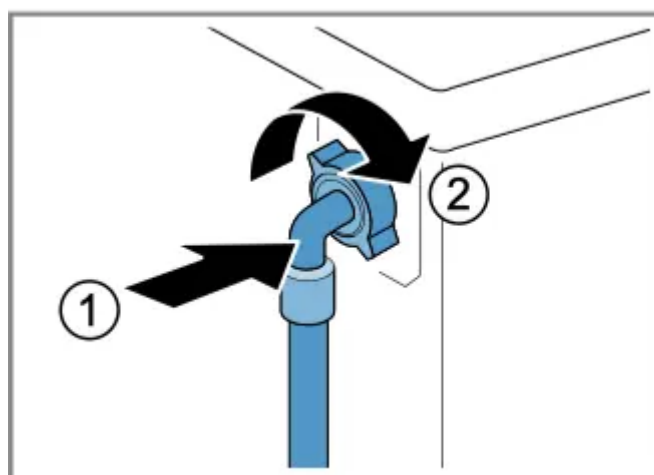

Troubleshooting

You can rectify minor faults on your appliance yourself. Read the troubleshooting information before contacting after-sales service. This will avoid unnecessary costs.



WARNING Risk of electric shock!

Improper repairs are dangerous.

- ▶ Repairs to the appliance should only be carried out by trained specialist staff.
- ▶ Only use genuine spare parts when repairing the appliance.
- ▶ If the power cord of this appliance is damaged, it must be replaced by the manufacturer, the manufacturer's Customer Service or a similarly qualified person in order to prevent any risk.

Error code / Fault display / Signal











Fault	Cause	troubleshooting
<p>The display goes out and Start/Reload  flashes</p>	Energy-saving mode is active	<p>▶ Press any button.</p> <p>√ The symbol lights up again.</p>
<p>"E:30 / -80"</p>	Drain pipe or water outlet hose is blocked.	▶ Clean the drain pipe and the water outlet hose.
	Drain pipe or water drain hose is caught or jammed.	▶ Ensure that the drain pipe and water drain hose are not kinked or trapped.
	Drain pump is blocked.	→ "Cleaning the drain pump", Page 42
	The water outlet hose is connected too high.	▶ Install the water outlet hose at a maximum height of 1 metre. → "Technical specifications", Page 59
	Pump cover is not correctly assembled.	▶ Correctly assemble the pump cover.
<p>"E:36 / -25 / -26"</p>	Drain pump is blocked.	▶ → "Cleaning the drain pump", Page 42
<p>"E:60 / -2B"</p>	The unbalanced load detection system has interrupted the spin cycle because the laundry is unevenly distributed.	<p>▶ Redistribute the laundry in the drum.</p> <p>Note: Where possible, mix large and small items in the drum. Different sized items of laundry distribute themselves better during the spin cycle.</p>
	The water pressure is low.	No remedial action possible.
	The filters in the water inflow are blocked.	▶ "Clean the filters in the water inflow" → Page 46.
	The tap is turned off.	▶ Turn on the tap.
	The water inlet hose is kinked or jammed.	▶ Ensure that the water inlet hose is not kinked or jammed.
	Detergent dosage is too high.	▶ Immediate measure: Mix one tablespoon of fabric softener with 0.5 litres of water and pour







		<p>the mixture into the left-hand compartment (not for outdoor clothing, sportswear or items stuffed with down).</p> <p>▶ Reduce the amount of detergent for the next washing cycle with the same load.</p>
All other error codes.	Malfunction	<p>▶ Call the after-sales service. → "Customer Service", Page 57</p>





Malfunctions



Fault	Cause	troubleshooting
The appliance is not working.	The mains plug of the power cord is not plugged in.	Connect the appliance to the power supply.
	The circuit breaker is faulty.	Check the circuit breaker in the fuse box.
	There has been a power cut.	Check whether the lighting in your kitchen or other appliances are working.
The programme does not start.	You have not pressed Start/Reload 	Press Start/Reload  .
	Door is not closed.	<ol style="list-style-type: none"> 1. Close the door. 2. Press Start/Reload  to start the programme.
	Childproof lock is activated.	→ "Deactivating the childproof lock", Page 39
	- Finished in  + is activated.	Check whether - Finished in  + is activated. → "Buttons", Page 24
	Laundry is caught in the door.	<ol style="list-style-type: none"> 1. Open the door again. 2. Remove any trapped laundry. 3. Close the door. 4. Press Start/Reload to start the programme.
The door cannot be opened.	 is activated.	Continue the programme by selecting  Spin or  Drain and pressing Start/Reload . → "Resuming the programme when the programme status is Rinse Hold", Page 38
		Wait until the temperature has dropped.

	The temperature is too high.	→ "Cancelling the programme", Page 38
	Water level is too high.	Start the  Drain programme.
	Power failure	Open the door using the emergency release. → "Emergency release", Page 55
The water is not draining.	Drain pipe or water outlet hose is blocked.	Clean the drain pipe and the water outlet hose.
	Drain pipe or water drain hose is caught or jammed.	Ensure that the drain pipe and water drain hose are not kinked or trapped.
	Drain pump is blocked.	→ "Cleaning the drain pump", Page 42
	 is activated.	Continue the programme by selecting  Spin or  Drain and pressing Start/Reload  .
	The water outlet hose is connected too high.	Install the water outlet hose at a maximum height of 1 metre. → "Technical specifications", Page 59
	Pump cover is not correctly assembled.	Correctly assemble the pump cover.
	Pump cover is not correctly assembled.	Correctly assemble the pump cover.
Water is not flowing in. Detergent is not being dispensed.	You have not pressed Start/ Reload  .	Press Start/Reload  .
	The filters in the water inflow are blocked.	"Clean the filters in the water inflow" → Page 46.
	The tap is turned off.	Turn on the tap.
	The water inlet hose is kinked or jammed.	Ensure that the water inlet hose is not kinked or jammed.





<p>The spin cycle runs several times.</p>	<p>The unbalanced load detection system eliminates an imbalance by repeatedly redistributing the laundry</p>	<p>Not a fault – no action required.</p> <p>Note: When loading, where possible, place large and small items of laundry together in the drum. Different sized items of laundry distribute themselves better during the spin cycle.</p>
<p>The programme duration changes during the wash cycle.</p>	<p>The programme operation is optimised electronically. This may change the programme duration.</p>	<p>Not a fault – no action required.</p>
	<p>The unbalanced load detection system eliminates an imbalance by repeatedly redistributing the laundry</p>	<p>Not a fault – no action required.</p> <p>Note: When loading, where possible, place large and small items of laundry together in the drum. Different sized items of laundry distribute themselves better during the spin cycle.</p>
	<p>Foam detection system switches on a rinse cycle if foam build-up is too high.</p>	<p>Not a fault – no action required.</p>
<p>No water is visible in the drum.</p>	<p>Water is below the visible area.</p>	<p>Not a fault – no action required.</p>
<p>Drum jerks after the programme starts.</p>	<p>This is caused by an internal motor test.</p>	<p>Not a fault – no action required.</p>
<p>Residual water is present in the compartment </p>	<p>Insert in compartment  is blocked.</p>	<p>→ "Cleaning the detergent drawer", Page 41</p>
<p>Vibrations and movement of the appliance whilst spinning.</p>	<p>Appliance is not correctly aligned.</p>	<p>Aligning the appliance</p>
	<p>The appliance feet are not fixed.</p>	<p>Secure the appliance feet. Aligning the appliance</p>
	<p>Transit bolts have not been removed.</p>	<p>Removing the transit bolts</p>

Drum does not turn, water does not flow in.	Load detection is active.	Not a fault – no action required. Note: The load detection can take up to two minutes.
Heavy foam build-up	Detergent dosage is too high.	<p>► Immediate measure: Mix one tablespoon of fabric softener with 0.5 litres of water and pour the mixture into the left-hand compartment (not for outdoor clothing, sportswear or items stuffed with down).</p> <p>► Reduce the amount of detergent for the next washing cycle with the same load.</p>

Noise

Fault	Cause	troubleshooting
Rushing, hissing noise.	Water is flushed under pressure into the detergent drawer.	Not a fault – normal operating noise.
Loud noises during the spin cycle.	Appliance is not correctly aligned.	Aligning the appliance
	The appliance feet are not fixed.	Secure the appliance feet. Aligning the appliance
	Transit bolts have not been removed.	Removing the transit bolts
Banging noises, rattling in the drain pump.	Foreign bodies have got into the drain pump.	→ "Cleaning the drain pump", Page 42
Slurping, rhythmical suction noise.	The drain pump is active, the detergent solution is pumped out.	Not a fault – normal operating noise.

Problem with results

Fault	Cause	troubleshooting
Creasing.	The spin speed is too high.	The next time you run a wash cycle, set a lower spin speed.
	The load is too large.	The next time you run a wash cycle, reduce the amount of laundry being loaded.
	The wrong programme is selected for the type of fabric.	Select the programmes that are suitable for the type of fabric. → "Programmes", Page 26
Detergent or fabric softener drips off the seal and collects on the door or in the seal fold.	Too much detergent/fabric softener in the detergent drawer.	When dosing liquid detergent and fabric softener, observe the marking in the detergent drawer and do not dose above this.
The spin result is not satisfactory. The laundry is too wet/too damp	A low spin speed is selected.	<ul style="list-style-type: none"> ▶ The next time you run a wash cycle, set a higher spin speed. ▶ Start the  Spin programme.
	Easy Iron  is activated.	Select the programmes that are suitable for the type of fabric. → "Programmes", Page 26
	The unbalanced load detection system has interrupted the spin cycle because the laundry is unevenly distributed.	<ul style="list-style-type: none"> ▶ Redistribute the laundry in the drum. <p>Note: Where possible, mix large and small items in the drum. Different sized items of laundry distribute themselves better during the spin cycle.</p> <ul style="list-style-type: none"> ▶ Start the  Spin programme.
Detergent residue on the damp washing.	Detergents may contain water-insoluble substances that deposit on the laundry.	Start the Rinse  programme.
Detergent residue on the dry laundry		Brush out the laundry after washing and drying.

	Detergents may contain water-insoluble substances that deposit on the laundry.	
--	--	--

Leakage

Fault	Cause	troubleshooting
Water is leaking out at the water inlet hose.	Water inlet hose is not correctly/securely connected.	<ol style="list-style-type: none"> 1. Connect the water supply hose correctly. Connecting the water inlet hose 2. Tighten the screw connection.
Water is leaking out at the water outlet hose.	The water outlet hose is damaged.	Replace the damaged water outlet hose.
	Water outlet hose is not connected correctly	Connect the water outlet hose correctly. Water outlet connection types

Odours

Fault	Cause	troubleshooting
Odours have formed in the appliance.	Humidity and detergent residue may promote the formation of bacteria.	<ul style="list-style-type: none"> ▶ → "Cleaning the drum", Page 41 ▶ If you are not using the appliance, leave the door and detergent drawer open so that residual water can evaporate.

Emergency release

To remove the laundry in the event of a power failure, for example, you can manually release the door.

Releasing the door

Requirement: "The drain pump is empty." → Page 42

1. ATTENTION! Escaping water may cause material damage.

▶ Do not open the door if you can see water through the glass.

Pull the emergency release downwards with a tool and release.

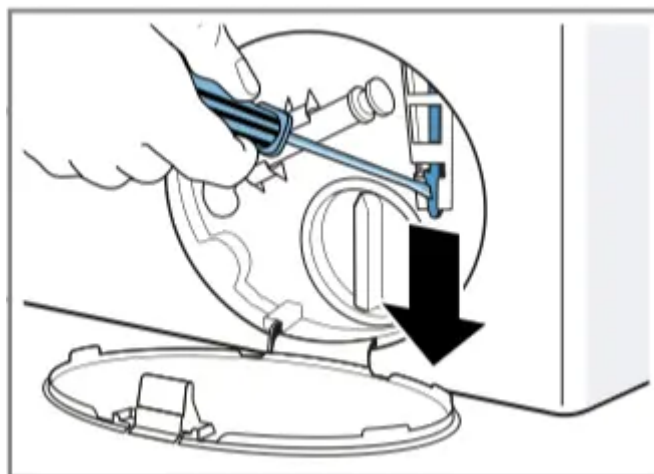

- √ The door lock is released.
2. Insert the maintenance flap and lock it into place.
3. Close the maintenance flap.

Transportation, storage and disposal

You can find out here how to prepare your appliance for transportation and storage. You will also find out how to dispose of old appliances.

Removing the appliance

1. Turn off the tap.
2. → "Emptying the water inlet hose", Page 46.
3. Switch off the appliance.
4. Unplug the appliance's mains plug.
5. Drain the remaining detergent solution.
→ "Cleaning the drain pump", Page 42
6. Detach the hoses.

Inserting the transit bolts

Secure the appliance for transportation using transit bolts in order to prevent damage.

1. Remove the four cover caps.
– If necessary, use a screwdriver to remove the cover caps.

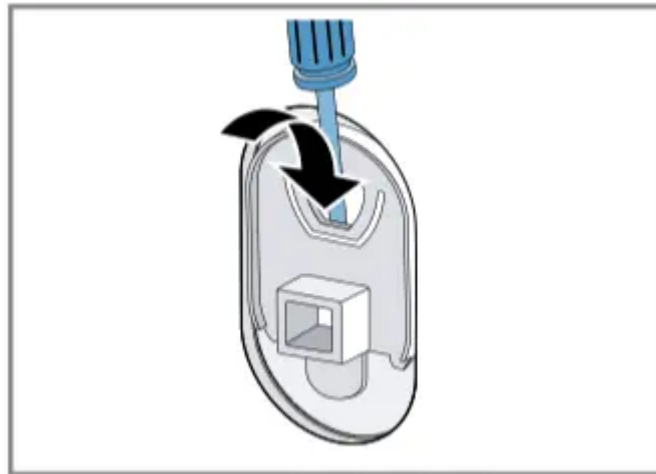

Keep the cover caps.

2. Insert the four sleeves.

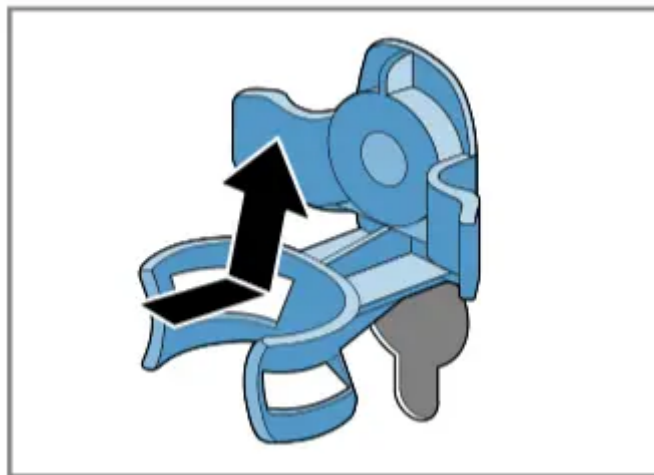

3. Insert all screws into the four transit bolts and tighten slightly.

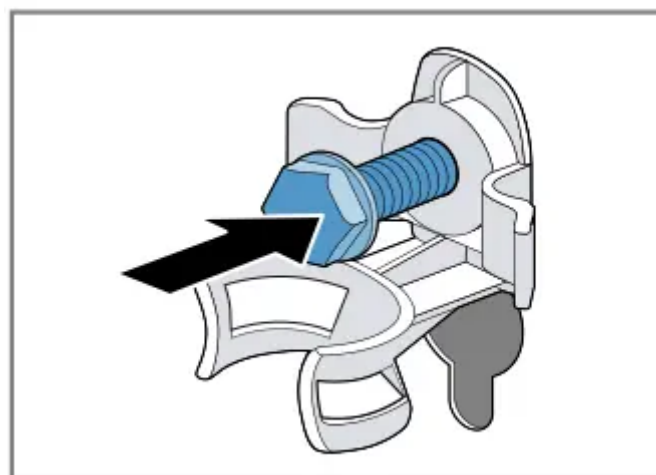

4. Insert the power cord into the holder ^① and tighten all four screws for the transit bolts with a WAF 13 wrench ^②.

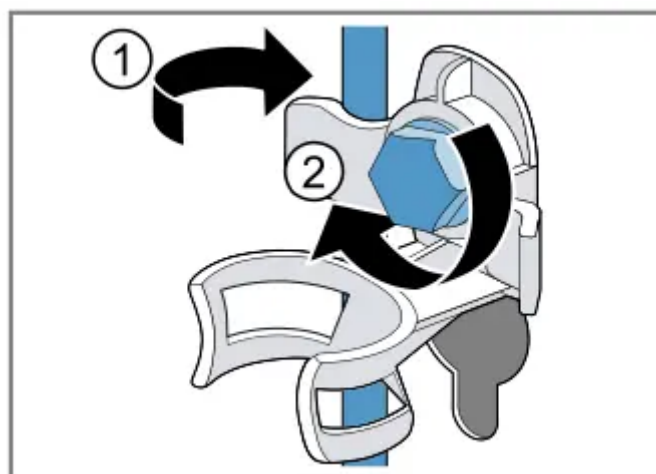

5. Insert the hose into holder.

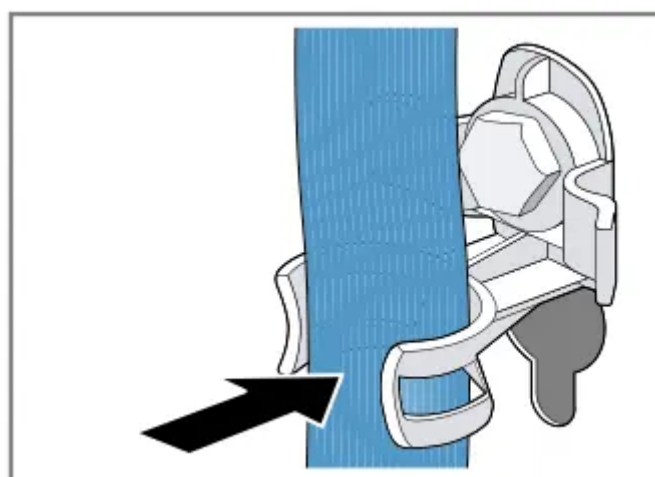

Using the appliance again

1. Remove the transit bolts.
2. Pour approx. 1 litre of water into compartment II in the detergent drawer.
3. Start the  Drain programme.

√ The unused detergent cannot flow straight into the outlet during the next wash.

Warning

This content is compiled from multiple sources and is provided for reference purposes only. It may not be complete or fully applicable to all situations. If you are unable to resolve your issue, please contact the product manufacturer or an authorized service provider for official support.