

PRODUCT OVERVIEW

Product Features

- The images in this guide may be different from the actual components and accessories, which are subject to change by the manufacturer without prior notice for product improvement purposes.
- NOTE: For your safety and for extended product life, use only authorized components. The manufacturer is not responsible for product malfunction, property damage or bodily injury caused by the use of separately purchased unauthorized components, parts, or non-LG products.

Front View

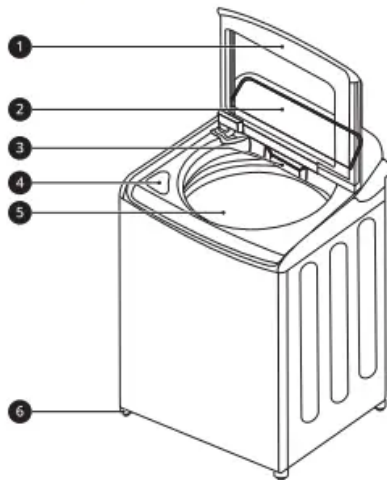

- ❶ Lid
- ❷ Control Panel
- ❸ Detergent Dispenser Drawer
- ❹ Liquid Bleach Compartment
- ❺ Tub
- ❻ Leveling Feet

Rear View

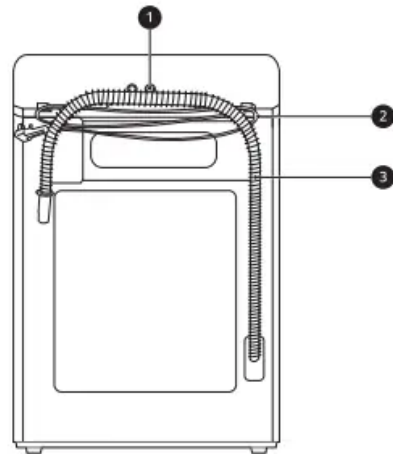

- ❶ Water Inlets
- ❷ Power Cord
- ❸ Drain Hose

Accessories

Included Accessories

① Tie Strap



Required Accessories

① Hot and Cold Water Hoses



Product Specifications: The appearance and specifications listed in this manual may vary due to constant product improvements

Model	WT7150C*	WT7000C*
Electrical Requirements	120 VAC @ 60 Hz	
Min. / Max. Water Pressure	20 - 120 psi (138 - 827 kPa)	
Dimensions (Width X Depth X Height)	27" X 28 3/8" X 44 1/2" (68.6 cm X 72.1 cm X 113 cm)	
Maximum Height with Lid Open	57 1/4" (145.3 cm)	
Net Weight	127.9 lbs (58 kg)	123.5 lbs (56 kg)
Max. Spin Speed	800 RPM (±50 rpm)	

OPERATION

Before Use

WARNING: To reduce the risk of fire, electric shock, or injury to persons, read the SAFETY INSTRUCTIONS before operating this appliance.

Operation Overview

- Sort laundry and load the washer.
 - Sort laundry by fabric type, soil level, color and load size, as needed. Open the lid and load items into the washer.
 - If using single-use detergent packs, or gel or tablet detergents, place them in the tub before loading the laundry.
- Add cleaning products.
 - Add the proper amount of HE (HighEfficiency) detergent to the detergent dispenser.
 - If desired, add bleach or fabric softener to the appropriate dispensers.
 - Do not place liquid or powdered detergent packs, or gel or tablet detergents in the dispenser.

3. Turn on the washer.

- Press the Power button to turn on the washer.
- The lights above the cycle buttons will illuminate and a chime will sound.

4. Select a cycle.

- Turn the cycle selector knob or press the cycle buttons repeatedly until the desired cycle is selected.
- The preset wash temperature, spin speed, soil level and option settings for the selected cycle are shown.
- The Normal cycle must be selected in order to change its default settings.
- Pressing the Start/Pause button without selecting a cycle immediately starts the Normal cycle with the default settings.

5. Adjust settings.

- Default settings for the selected cycle can be changed, if desired, using the cycle modifier and option buttons.
- Not all modifiers and options are available on all cycles. A different chime sounds and the LED does not light up if the selection is not allowed.

6. Begin cycle.

- Press the Start/Pause button to begin the cycle. The lid locks, and the washer agitates briefly without water to measure the weight of the load.
- If the Start/Pause button is not pressed within a certain time, the washer shuts off and all settings are lost.

7. If necessary, add additional items to the tub while the Add Garments light is on.

- This light turns on at the beginning of the wash cycle to indicate when it is safe to add items to the tub.
- Press the Start/Pause button to pause the cycle and add items to the tub. Press the Start/Pause button to resume the cycle.
- Adding items after the Add Garments light turns off may result in poor wash performance.

8. End of cycle.

- When the cycle is finished, a melody sounds. Immediately remove the clothing from the washer to reduce wrinkling.
- If the washer includes lint filters, remember to check lint filters after every 2 to 3 loads.

Sorting Laundry

CAUTION

- The washer can be fully loaded, but the tub should not be tightly packed with items. The lid of the washer should close easily.
- Use the Bedding cycle for buoyant or nonabsorbent items such as pillows or comforters. Failure to follow this caution can result in leakage.
- Clothing or articles that are waterproof or water resistant must be washed in the Waterproof cycle only. (Examples include water resistant clothing, mattress covers, outdoor clothes, and plastic mats.) Using another cycle may result in personal injury or damage to the washer, clothes, walls, floor, and surrounding objects due to abnormal vibration.

Grouping Similar Items











- For the best washing results, and to reduce the possibility of damage to clothing, sort clothing into loads made up of similar items.
- Mixing different fabric types and/or soil levels can result in poor wash performance, color transfer, discoloration, fabric damage or linting. Fabrics should be sorted into groups as described below.
- Colors: Sort articles by color. Wash dark clothes separately from light colors or whites. Mixing dark clothes with light clothes can result in dye transfer or discoloration of the lighter clothes.
- Soil Level: Wash heavily soiled clothing together. Washing lightly soiled clothing in the same load with heavily soiled clothing could result in poor wash performance for the lightly soiled clothing. Fabric Type Delicate articles should not be mixed with heavy or sturdy fabric types. Washing heavy fabrics with delicates can result in poor wash performance for the heavy fabrics and possible damage to the delicates.
- Lint Type: Some fabrics attract and bind lint to them while others give off lint in the laundry process. Avoid mixing these lint collectors and lint producers in the same load. Mixing these fabrics will result in pilling and linting on the lint collectors. (For example, lint collector - knit sweater; lint producer - terry cloth towels.)

How to Sort Laundry

By Colors	By Soil	By Fabric	By Lint
White	Heavy	Delicates	Lint Producer
Lights	Normal	Easy Care	Lint Collector
Darks	Light	Sturdy	

Fabric Care Labels

Many articles of clothing include a fabric care label. Using the chart below, adjust the cycle and option selections to care for your clothing according to the manufacturer's recommendations.

Category	Label	Directions
 Washing		Hand wash
		Machine wash, Normal cycle
		Perm Press/Wrinkle Resistant setting (which has a cool down or cold spray before the slower spin)
		Gentle/Delicate setting (slow agitation and/or reduced wash time)
		Do not wash
		Do not wring
Water Temperature	...	Hot
	..	Warm
	.	Cold/Cool
 Bleach Symbols		Any bleach (when needed)
		Only non-chlorine bleach (when needed)
		Do not bleach

Loading the Washer

General Tips

- Check and empty pockets. Paper clips, coins, matches, and other items can damage clothing and the washer.
- Close zippers and hooks, and tie drawstrings to prevent snagging or tangling of clothes.
- Pretreat heavily stained areas for best results.
- Brush off heavy soil, dust, and hair from items before washing. Excess dirt or sand can abrade other fabrics and lead to poor wash performance.

- Combine large and small items in the tub. Load large items first. Large items should not be more than half of total load.
- For best results, load dry items only. If washing very wet items, wring out excess water before loading, or run a Spin Only cycle to extract excess water before adding detergent and starting the desired cycle.
- The washer can be fully loaded, but the tub should not be tightly packed with items. The lid of the washer must close easily

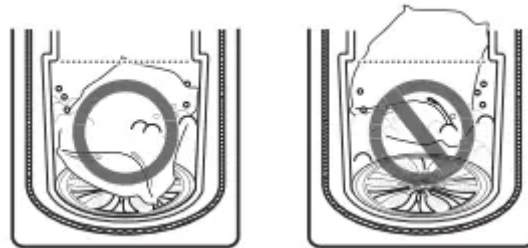

- The washer will not fill or operate with the lid open.
- Do not overload the tub. Clothes should fit loosely in the tub under the maximum fill line
 1. Loading clothes over the fill line may result in damage to clothing and the washer.
 - Do not press down on items while stacking them in the tub.
 - Load clothes loosely, and do not overfill the tub. Clothes need room to circulate in order to get clean.

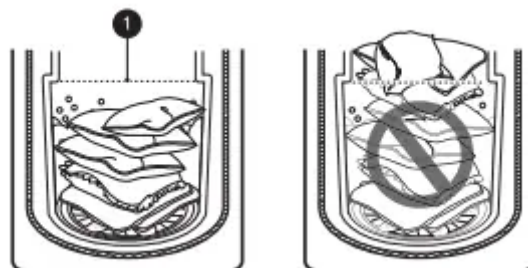

Bulky Items

- Do not wash entire pillows or cushions. Remove pillow or cushion inserts and wash the covers only. • Use the Bedding cycle for large or bulky items such as poly-filled jackets, comforters, pillows, etc. These items may not be as absorbent as other laundry items and should be sorted into a separate wash load for best performance.
- Bulky items should be placed as far down in the tub as possible for best performance. Always place buoyant items at the bottom of the tub. The washer will automatically detect the load size. Because of the high efficiency wash system, the water level may not completely cover the load.

Small Items

- Do not wash a single small item. Add enough similar items to the load to prevent an out-of-balance load.
- Wash small, light items in a mesh bag. Small items can get caught in the impeller at the bottom of the tub, and brassiere hooks can damage other items or the tub.

General Tips for Models with an Impeller

If the appliance uses a low profile rotating hub in the drum, follow these instructions when loading the washer.

- For best performance, load clothes as shown.

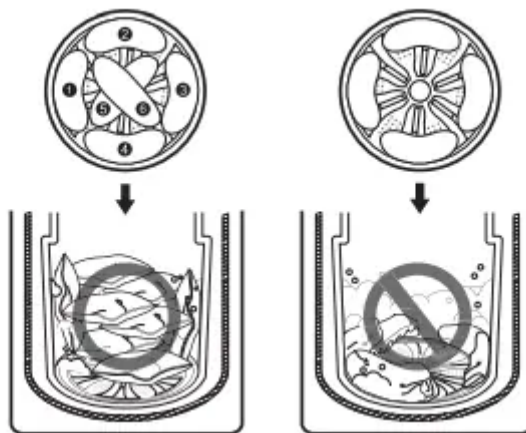

- Wash thick, bulky items individually. Heavy blankets, comforters, bedspreads, or pet beds can get tangled or cause an unbalanced load if combined with other items.

Adding Cleaning Products

About Detergent Use: This washer is designed for use with only HE (HighEfficiency) detergents.



- HE detergents produce fewer suds, dissolve more efficiently to improve washing and rinsing performance, and help to keep the interior of the washer clean. Using detergent that is not HE may cause oversudsing and unsatisfactory performance which could result in error codes, cycle failure, and washer damage.
- Detergents designated as HE-compatible may not provide optimal results.
- For proper wash performance, always measure detergent using the measuring device provided by the detergent manufacturer. For an average load, use less than half of the recommended maximum. Use less detergent for soft water, light soil, or smaller loads.

- Use extra care when measuring 2X and 3X concentrated detergents because even a small amount of extra detergent can lead to problems.
- Never use more than the maximum amount of detergent recommended by the manufacturer. Using too much detergent can lead to oversudsing, poor rinsing, detergent buildup in clothing, and residue buildup that can contribute to odors in the washer.
- Do not use more than one single-use detergent pack or detergent tablet in the washer. Using too much detergent may cause oversudsing and unsatisfactory performance. Reduce detergent amount or add an extra rinse if detergent residue is left on fabrics. To add an extra rinse, select the Extra Rinse option.

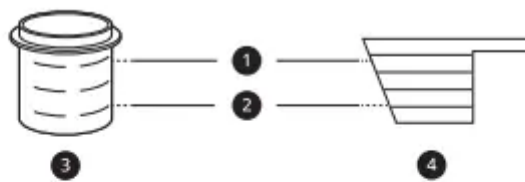

- ❶ Maximum fill line
- ❷ Average load fill line
- ❸ Liquid detergent
- ❹ Powdered detergent

Single-Use Detergent Packs / Gel or Tablet Detergents

- Place liquid or powdered detergent packs, or gel or tablet detergents in the tub before loading laundry. Do not place these detergents in the dispenser.

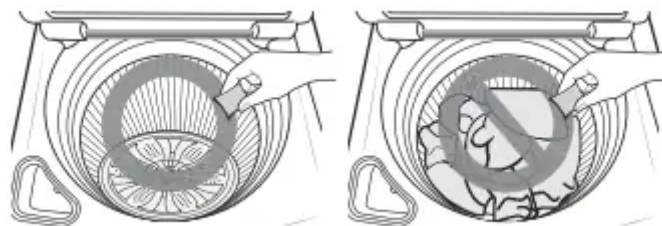

About the Dispensers: The automatic dispenser consists of two compartments which hold:

- Liquid fabric softener
- Liquid or powdered detergent for main wash

Using the Detergent and Softener Dispenser Drawer: To add detergent and fabric softener to the automatic dispenser drawer:

1. Open the dispenser drawer.
2. Load the laundry products into the appropriate compartments.

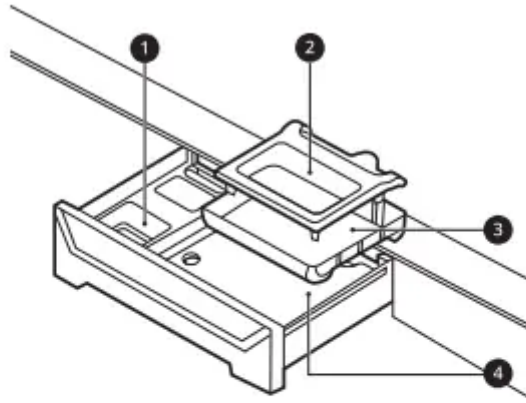

- ❶ Liquid fabric softener compartment
- ❷ Main wash liquid detergent cup
- ❸ Insert
- ❹ Main wash powdered detergent compartment

3. Gently close the detergent dispenser drawer before starting the cycle.

- Slamming the drawer closed may result in the detergent overflowing into another compartment or dispensing into the drum earlier than programmed.
- Be careful not to get a hand caught in the drawer while closing.
- It is normal for a small amount of water to remain in the dispenser compartments at the end of the cycle.

Main Wash Detergent Compartment: This compartment holds laundry detergent for the main wash cycle. Either powdered or liquid detergent may be used in this compartment.

- The detergent is added to the load at the beginning of the cycle. Always use HE (HighEfficiency) detergent with your washer.
- Do not exceed the maximum fill line. Using too much detergent can result in detergent buildup in clothing and the washer.
- Liquid or powdered color-safe bleach may be added to the main wash compartment with detergent of the same type. Do not mix liquids and powders.
- When using liquid detergent, make sure the liquid detergent cup and insert are in place.
- When using powdered detergent, remove the insert and liquid detergent cup from the dispenser. Powdered detergent will not dispense with the liquid detergent cup and insert in place.
- If you use a detergent that does not dissolve easily or a detergent with high viscosity, it will leave a residue and clog the dispenser.

Fabric Softener Compartment: This compartment holds liquid fabric softener, which is automatically dispensed during the final rinse cycle.

- Do not exceed the maximum fill line. Using too much fabric softener may stain clothes.
- Dilute concentrated fabric softeners with warm water.
- Never pour fabric softener directly onto the load or into the tub

Using the Liquid Bleach Dispenser: The bleach dispenser is a separate compartment at the left front of the tub opening.

WARNING: Do not mix chlorine bleach with ammonia or acids such as vinegar or rust/scale remover. Mixing chemicals like these can produce a lethal gas, resulting in severe injury or death.

1. Check clothing care labels for special instructions.
2. Measure liquid bleach carefully, following the instructions on the bottle.
 - HE (High-Efficiency) washers use less water, so less bleach is needed. One half cup is enough for most loads.
3. Carefully pour the pre-measured amount of bleach directly into the bleach dispenser.
 - If you are using powdered bleach of any kind, pour it directly into the tub before adding the laundry.
 - Never add powdered bleach to the liquid bleach dispenser.

Automatic Bleach Dispenser: On some models, the bleach dispenser is connected to the inlet valve. The bleach is automatically diluted and dispensed at the proper time in the wash cycle.

- The dispenser is activated twice to ensure complete dispensing of the bleach. Any liquid remaining in the dispenser at the end of the cycle is water, not bleach

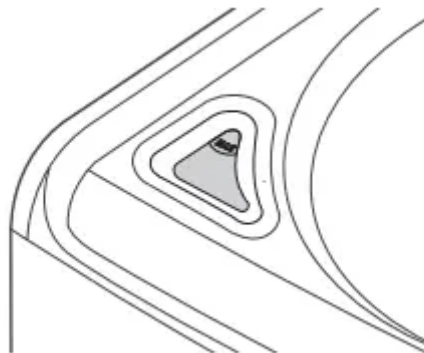

Immediate Bleach Dispenser: On some models, when you pour the bleach into the bleach dispenser, the bleach is immediately added to the tub as it fills with water, safely diluting the bleach.

- The dispenser cover cannot be removed. To clean the cover, wipe it with a damp paper towel.

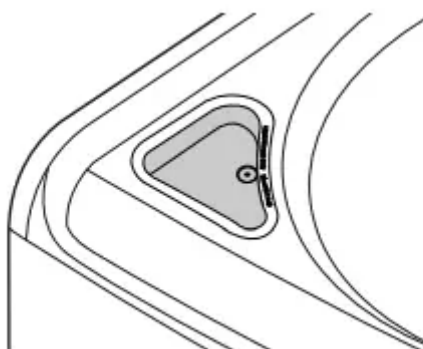

Control Panel

Control Panel Features

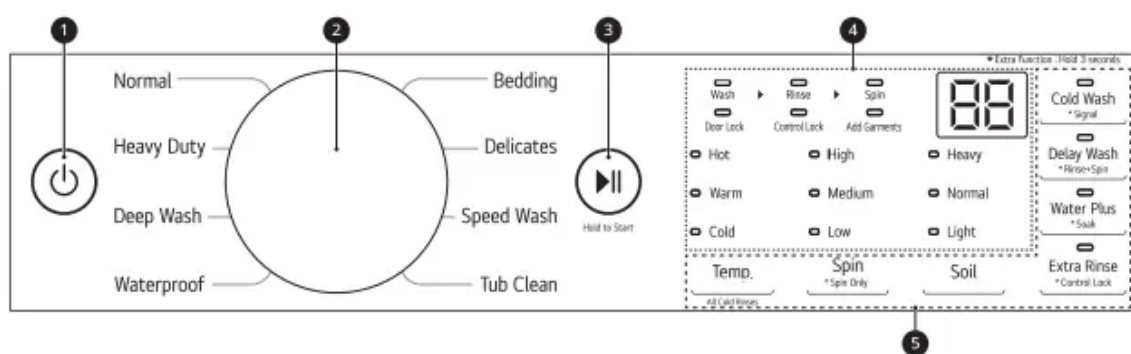

1. Power On/Off Button

- Press this button to turn the washer on or off.
- Pressing this button during a cycle will cancel that cycle and any load settings will be lost.
- The door will unlock after a brief pause.

2. Cycle Selector Knob

- Turn this knob to select the desired cycle.
- Once the desired cycle has been selected, the standard presets will appear in the display. These settings can be adjusted using the Cycle Modifier buttons at any time before starting the cycle.

3. Start/Pause Button

- Press this button to start the selected cycle.
- If the washer is running, use this button to pause the cycle without losing the current settings.

4. Time and Status Display

- The display shows the settings, estimated time remaining, options, and status messages for the washer.

5. Cycle Modifier Buttons

- Use these buttons to adjust the wash temperature, spin speed and soil level settings for the selected cycle.
- The current settings are shown in the display.
- Press the button for that option to select other settings.

6. Option and Extra Function Buttons

- These buttons allow you to select additional cycle options. Certain buttons also allow you to activate special functions by pressing and holding the button for 3 seconds.

Time and Status Display

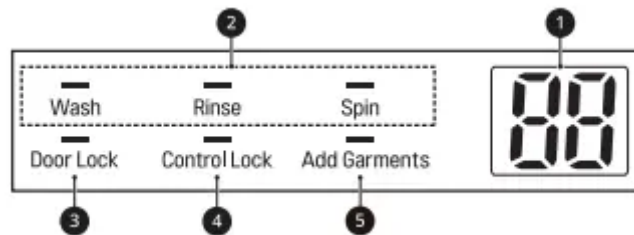

1. Estimated Time Remaining

- When a cycle is selected, the default time for that cycle is displayed. This time will change as modifiers or options are selected.
- If the display shows --, then the time will be displayed after the load sensing has detected the load size.
- The time shown is only an estimate. This time is based on normal operating conditions. Several external factors (load size, room temperature, incoming water temperature, etc.) can affect the actual time

2. Cycle Status Indicators

- These LEDs will blink when a cycle is selected to indicate which stages will run.
- When a cycle is running, the LED for the active stage will blink, and the LEDs for the remaining stages will remain steady. Once a stage is complete, the LED will turn off. If a cycle is paused, the active stage LED will stop blinking.

3. Door Lock Indicator

- This indicator lights up when the cycle starts and the door is locked.
- The indicator light stays on until the cycle is paused, stopped or has finished.

4. Control Lock Indicator

- This indicator lights up when the control panel is locked.
- CL and the remaining wash time are displayed, in turn, on the time remaining display.
- When this function is set, all controls are disabled except for the Power button.

5. Add Garment Indicator

- Laundry may only be added to the tub at the proper time in the wash cycle. When this indicator lights up, it is safe to pause the cycle and add more items to the tub.
- If garments are added when this indicator turns off, the washer will not adjust for these items which could result in poor performance and/or fabric damage.

Cycle Modifiers

About Modifier Buttons: Each cycle has default settings that are selected automatically. You may also customize these settings using the cycle modifier buttons.

- Repeatedly press the button for the desired modifier until the indicator light for the desired setting is lit.
- The washer automatically adjusts the water level for the type and size of wash load for best results and maximum efficiency.
- This is a high-efficiency washer, and the water levels may be much lower than you expect. This is normal, and cleaning/rinsing performance will not be compromised.

▪ Hot	▪ High	▪ Heavy
▪ Warm	▪ Medium	▪ Normal
▪ Cold	▪ Low	▪ Light
Temp.	Spin	Soil

Temp.: Make sure the water temperature is suitable for the type of load you are washing.

- Press the Temp. button repeatedly to select the wash and rinse temperature combination for the selected cycle.
- All rinses use unheated cold water.
- Cold rinses use less energy. The actual cold rinse temperature depends on the temperature of the cold water at the faucet.

Spin: Higher spin speeds extract more water from clothes, reducing drying time and saving energy

- Press the Spin button repeatedly until the desired speed is selected.
- Some fabrics, such as delicates, require a slower spin speed. To protect your clothing, not all spin speeds are available for all cycles.

Soil: Adjusting the soil level setting will modify the cycle times and/or wash actions.

- Press the Soil button repeatedly until the desired soil level is selected.
- The Heavy soil setting may increase cycle times. The Light soil setting may decrease cycle times.

Options and Extra Functions

Your washer includes several additional cycle options to customize cycles to meet your individual needs.

- Select the desired option after selecting the desired cycle and settings.

Spin Only: Use this option to spin clothes and drain the water from the tub. Use this option to drain water if the wash cycle is interrupted by a power failure or to spin dry hand-washed items.

1. Press the Power button to turn on the washer.
 - Do not select a cycle.
2. Press and hold the Spin button for 3 seconds.
 - You can change the spin speed by pressing the Spin button.
3. Press the Start/Pause button to begin.

Cold Wash Use this option to save energy by using cooler water while increasing the wash and rinse times to maintain wash performance.

- Wash time will increase up to several minutes with this option.
- Selecting this option increases the water supplied during rinsing. The water supplied during washing is not increased.
- For best wash results, only wash small loads (less than 8 lb) with this option.

Signal The washer plays a melody when the wash cycle is finished. The buttons make a sound each time they are pressed.

- Press and hold the Cold Wash button for 3 seconds to turn the sounds on or off. • When no signal is heard, the signal is off.

Delay Wash Once you have selected the cycle and other settings, press this button to delay the start of the wash cycle.

- Each press of the button increases the delay time by 1 hour, for up to 19 hours.
- Once the desired delay time is set, press the Start/Pause button to start the delay time.

Rinse+Spin Select this option to rinse and spin a load separately from a regular cycle. This can be helpful in preventing fresh stains from setting in fabrics.

1. Press the Power button to turn on the washer.
 - Do not select a cycle.
2. Press and hold the Delay Wash button for 3 seconds.
 - You can change the spin speed by pressing the Spin button.
3. Press the Start/Pause button to begin.

Water Plus

- Use this option to add extra water to the wash cycle for better wash performance with large or bulky items.
- NOTE
 - If the washer reaches its maximum water level, this button will have no effect.
 - To add more water while a cycle is running, pause the cycle and select this option.
 - When you select Normal cycle and Water Plus option, the cycle will be changed to Deep Wash cycle before starting.

Soak This option provides a 30-minute presoak prior to the start of the selected cycle. Use this option to presoak garments to help remove difficult spots or stains on fabrics. At the end of the presoak time, the selected cycle will begin with the same water used for soaking.

- Press and hold the Water Plus button for 3 seconds to activate or deactivate this option.

Extra Rinse This option adds an extra rinse to the selected cycle. Use this option to help ensure the removal of detergent or bleach residue from fabrics.

- Pressing the Extra Rinse button twice will add two additional rinses to the cycle.
- If a liquid fabric softener is used, it is always dispensed in the final rinse.

Control Lock Use this function to disable the controls. This function can prevent children from changing cycles or operating this washer

Locking the Control Panel

1. Turn on the power.
2. Press and hold the Extra Rinse button for 3 seconds to activate this function.

Unlocking the Control Panel

1. Turn on the power.
2. Press and hold the Extra Rinse button for 3 seconds to deactivate this function.
 - When this function is deactivated, a chime will sound and the remaining time for the current cycle will reappear on the display

Add Garments If you've forgotten to add an item or need to remove foreign objects like coins or keys after the cycle has started, the best time to do so is while the Add Garments indicator is on. Once the indicator turns off, adding garments may affect the cycle time or wash performance.

1. Press the Start/Pause button. The cycle pauses and the lid (door) unlocks.
2. Open the lid, add garments or remove foreign objects, and close the lid.
3. Press the Start/Pause button to resume the cycle. The cycle continues automatically

NOTE

- This washer is equipped with a special drain feature that is designed to make your washer as safe as possible. If the washer is paused or shut off while there is still water in the tub, the water will drain automatically after several minutes of inactivity. This helps keep children safe by reducing the possibility of water remaining in the tub.

Any water remaining in the tub will automatically drain 4 minutes after the washer has shut off. If the washer is paused and the Start/Pause button is not pressed within 60 minutes, the washer will shut off and all cycle settings will be lost. Any water remaining in the tub will be drained.

The washer can be turned on or restarted any time before the drain begins. However, once the washer begins to drain, all controls and functions will be disabled until the water has been completely drained and the washer shuts off.

SMART FUNCTIONS

LG ThinQ Application

The LG ThinQ application allows you to communicate with the appliance using a smartphone.



LG ThinQ Application Features

- Smart Diagnosis: This function provides useful information for diagnosing and solving issues with the appliance based on the pattern of use.

Installing the LG ThinQ Application

- Search for the LG ThinQ application from the Google Play Store or Apple App Store on a smartphone. Follow instructions to download and install the application.



Smart Diagnosis™ Function

- This feature is only available on models with the  or  logo.
- Use this feature to help you diagnose and solve problems with your appliance.

Using Audible Diagnosis to Diagnose Issues

Follow the instructions below to use the audible diagnosis method. Launch the LG ThinQ application and select the Smart Diagnosis™ feature in the menu. Follow the instructions for audible diagnosis provided in the LG ThinQ application.

1. Press the Power button to turn on the appliance.
 - Do not press any other buttons.

2. Hold the mouthpiece of your phone in front of the  or  logo.

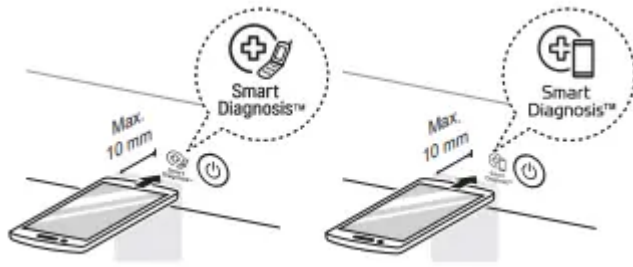

3. Press and hold the Temp. button for 3 seconds or longer while continuing to hold your phone near the logo.
4. Keep the phone in place until the tone transmission has finished. The display will count down the time. Once the countdown is over and the tones have stopped, the diagnosis will be displayed in the application.

MAINTENANCE

WARNING

- To reduce the risk of fire, electric shock, or injury to persons, read this entire owner's manual, including the SAFETY INSTRUCTIONS, before operating this appliance.
- Unplug the appliance before cleaning to avoid the risk of electric shock. Failure to follow this warning can cause serious injury, fire, electric shock, or death.
- Do not use volatile substances (benzene, paint thinner, alcohol, acetone, etc.), abrasive cleaners, or detergents with strong chemical components when cleaning the appliance. Doing so may cause discoloration or damage to the appliance, or may cause a fire.
- Certain internal parts are intentionally not grounded and may present a risk of electric shock only during servicing. Service personnel - Do not contact the following parts while the appliance is energized: pump, motor, noise filter cover, and heater (on applicable models).

Regular Cleaning

Care after Wash After the cycle is finished, wipe the lid and the inside of the lid seal to remove any moisture.

- Wipe the body of the washer with a dry cloth to remove any moisture.
- Leave the lid open to dry the tub interior.

NOTE

- Make sure children and pets do not climb into the tub. Engage the Control Lock feature if needed to prevent children from accidentally starting a wash cycle.

Cleaning the Exterior

- Proper care of your washer can extend its life.
- Lid: Wash with a damp cloth on the outside and inside and then dry with a soft cloth.
- Exterior:
 - Immediately wipe off any spills.
 - Wipe with a damp cloth.
 - Do not touch the surface or the display with sharp objects.

Periodic Maintenance

- Use a towel or soft cloth to wipe around the washer lid opening and lid glass.
- Always remove items from the washer as soon as the cycle is complete. Leaving damp items in the washer can cause wrinkling, color transfer, and odor.
- Run the Tub Clean cycle once a month, or more often if needed, to remove detergent buildup and other residue.

Cleaning the Tub

- Over time, residue may build up in the tub, leading to mildew or a musty odor. Run the Tub Clean cycle monthly to remove residue and prevent odor.
 - NOTE
 - Make sure to run the Tub Clean cycle only when the tub is empty. Never load laundry while using this cycle. The laundry may be damaged or contaminated with cleaning products.
 - Run the cycle more often under heavy use conditions or if odor is already present.
 - If mildew or musty smell already exists, run this cycle once a week for three consecutive weeks
1. Remove any clothing from the tub.
 2. Adding cleaning agents.

Cleaner	Instructions
Tub cleaner Lime scale remover	Follow manufacturer's recommendations.
Liquid chlorine bleach	Add to main wash liquid detergent dispenser.
Powdered cleaner	Follow manufacturer's recommendations.
Cleaning tablets	Place directly into the washer tub.

- For other tub cleaning products, follow the cleaner manufacturer's instructions and recommendations.
- Do not exceed the maximum fill line when adding bleach or powdered cleaners. Powdered cleaners may remain in the tub after cleaning.

3. Close the lid and press the Power button to turn on the washer.

4. Turn the knob or press the cycle buttons to select the Tub Clean cycle then press the Start/Pause button to begin the cycle.

5. After the cycle ends, open the lid and allow the tub interior to dry completely

WARNING: Make sure children and pets do not climb into the tub. Engage the Control Lock feature if needed to prevent children from accidentally starting a wash cycle.

NOTE: If you use a descaler or tub cleaner during the Tub Clean cycle, use the Rinse+Spin option to rinse the washer tub before running your next wash cycle.

Removing Mineral Buildup In areas with hard water, mineral scale can form on internal components of the washer. Periodically clean the mineral buildup on the internal components to extend the lifespan of the washer. Use of a water softener is recommended in areas with hard water.

- Use a descaler to remove visible mineral buildup on the washer tub.
- After descaling, always run the Tub Clean cycle before washing clothing.
- Mineral scale and other spots may be removed from the stainless steel tub using a soft cloth soaked in stainless steel cleaner.
- Do not use steel wool or abrasive cleaners.

Leaving the Lid Open After you finish using the washer, leave the lid open overnight to allow air to circulate and dry the tub. This helps prevent odors.

Cleaning the Dispenser Drawer Detergent and fabric softener may build up in the dispenser drawer. Remove the drawer and inserts and check for buildup once or twice a month.

WARNING: Do not spray water inside the washer. Doing so may cause fire or electric shock.

1. Turn off the washer, and unplug the power cord.
2. Remove the drawer by pulling it straight out until it stops. Lift the front of the drawer upwards and pull it completely out.

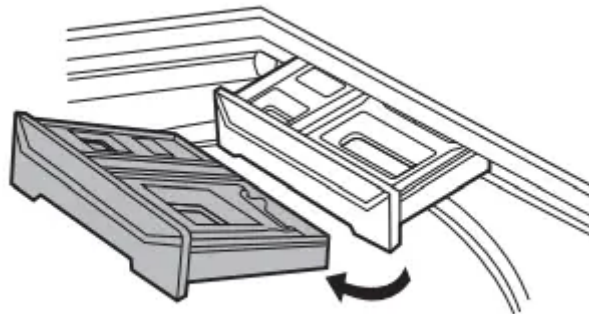

3. Remove the inserts from the two compartments.

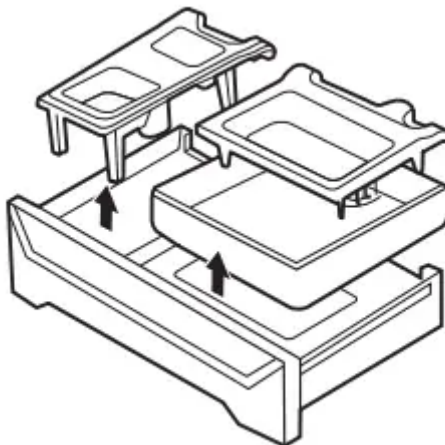

4. Clean the inserts and drawer with warm water.
 - Use a soft cloth or brush to clean and remove any residue.
 - Do not use soap when cleaning the drawer and inserts.
5. Wipe off any moisture with a dry towel or cloth after cleaning.
6. To clean the drawer opening, use a small, non-metal brush to clean the recess. Remove all residue from the upper and lower parts of the recess.
7. Return the inserts to the proper compartments and replace the drawer.
 - Set the drawer into the opening at an angle, then lower it and slide it into place.

Cleaning the Bleach Dispenser

Bleach may build up on the bleach dispenser cover. Check for buildup and clean the cover once or twice a month.

- Automatic Bleach Dispenser: Remove the cover from the bleach dispenser. Clean the cover and the opening with warm water.

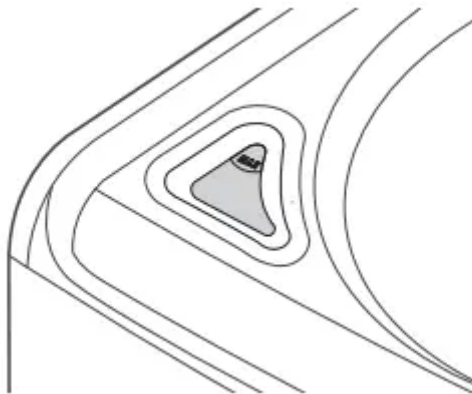

- Immediate Bleach Dispenser: The cover cannot be separated from the dispenser. Clean the cover using a brush and warm water.

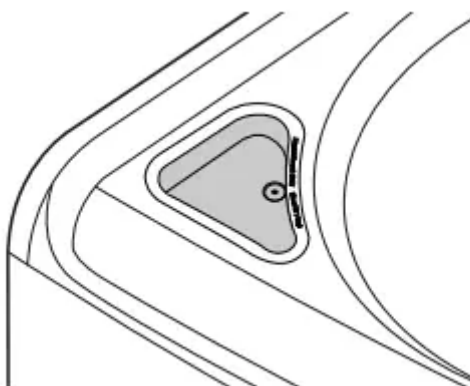

Cleaning the Water Inlet Filters

If the washer does not fill properly, an error message will appear on the display. The inlet valve filter screens could be clogged by hard water scale, sediment in the water supply, or other debris.

WARNING

- The inlet screens protect the delicate parts of the inlet valve from being damaged by particles that could enter the valves with the water supply. Operating the washer with these filters removed could cause a valve to open continuously, resulting in flooding and/or property damage.

CAUTION

- Do not use the washer without the inlet filters. Doing so it will cause leaks and malfunction.

- If you use the washer in an area with hard water, the inlet filter may clog due to lime buildup and require more frequent cleaning.

1. Turn off the washer, and unplug the power cord.
2. Turn off hot and cold water faucets.
3. Unscrew the hot and cold water hoses from the back of the washer.
4. Remove the filters from the water valves carefully.
 - Use pliers to pull out the filters from the water valves.

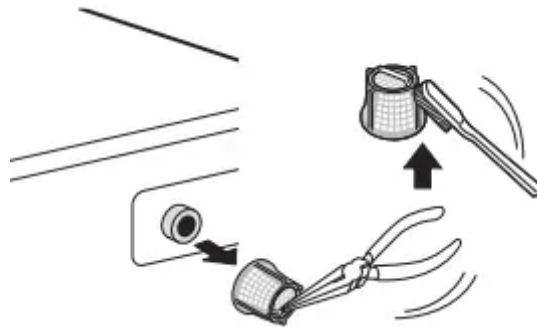

5. Remove foreign objects and soak the filters in white vinegar or a lime scale remover.
 - If using a lime scale remover, follow the manufacturer's instructions. Be careful not to damage the filters while cleaning them.
6. Rinse filters thoroughly and press them back into place.
7. Flush then reattach the water hoses.
 - Before reattaching the water inlet hoses, flush them by running several gallons of water through them into a bucket or drain, preferably with the faucets wide open for maximum flow.

NOTE: An **IE** error message may blink on the display when the water pressure is low or an inlet filter is clogged with dirt. Clean the inlet filter.

Care in Cold Climates

Storing the Washer If the washer will not be used for an extended period of time and is in an area that could be exposed to freezing temperatures, follow these steps to protect the washer from damage.

NOTE: Make sure the tub is empty before following these steps.

1. Turn off the washer, and unplug the power cord.
2. Turn off the water faucets.

3. Disconnect hoses from water supply and drain water from hoses.

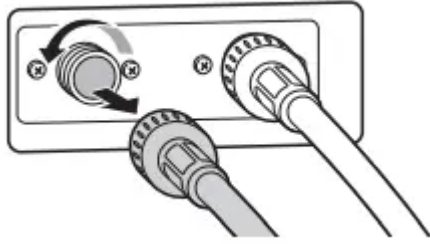

4. Plug the power cord into a properly grounded electrical outlet.
5. Add 1 gallon of nontoxic recreational vehicle (RV) antifreeze to the empty tub and close the lid.
 - Never use automotive antifreeze.
6. Turn on the washer and select the Spin cycle.
7. Press the Start/Pause button to start the drain pump for 1 minute.
 - This will expel some of the antifreeze, leaving enough to protect the washer from damage.
8. Turn off the washer and unplug the power cord.
9. Dry the tub interior with a soft cloth, and close the lid.
10. Store the washer in an upright position.
11. Remove the inserts from the dispenser. Drain any water in the compartments and let them dry.
12. To remove the antifreeze from the washer after storage, run a Speed Wash cycle using detergent.
 - Do not add laundry to this cycle.

When the Water Inlet Hoses are Frozen

1. Turn off the washer, and unplug the power cord.
2. Turn off the faucets connected to the water inlet hoses.
3. Pour hot water on the frozen faucets to thaw the water inlet hoses and remove the water inlet hoses.
4. Immerse the water inlet hoses in hot water to thaw them.
5. Reconnect the water inlet hoses to the water inlets of the washer and to the faucets.
 - See Connecting the Water Inlet Hoses for details.
6. Turn on the faucets.
7. Press the Power button to turn on the washer.

8. Press and hold the Spin button for 3 seconds to operate Spin Only cycle for draining and spinning.
9. Press the Start/Pause button and check that the water fills properly

When the Drain Hose is Frozen

1. Pour hot water in the washer tub and close the lid.
2. Wait for 1 - 2 hours.
3. Press the Power button to turn on the washer.
4. Press and hold the Spin button for 3 seconds to operate Spin Only cycle for draining and spinning.
5. Press the Start/Pause button to make sure the water drains.

TROUBLESHOOTING

The washer is equipped with an automatic error-monitoring system to detect and diagnose problems at an early stage. If the washer does not function properly or does not function at all, check the following before you call for service







Before Calling for Service

Error Messages

Problem	Possible Cause & Solution
<p style="text-align: center;">UE</p> <p style="text-align: center;">UNBALANCE ERROR</p>	<p style="text-align: center;">The load is too small.</p> <ul style="list-style-type: none"> • Add additional items to allow the washer to balance the load. Heavy articles are mixed with lighter items. • Always try to wash articles of somewhat similar weight to allow the washer to evenly distribute the weight of the load for spinning. <p style="text-align: center;">The load is out of balance.</p> <ul style="list-style-type: none"> • Manually redistribute the load if articles have become tangled, preventing the automatic rebalancing from working properly.
<p style="text-align: center;">IE</p> <p style="text-align: center;">INLET ERROR</p>	<p style="text-align: center;">Water supply faucets are not fully open.</p> <ul style="list-style-type: none"> • Make sure that the water faucets are fully open. Water inlet hoses are kinked, pinched, or crushed. • Make sure that the hoses are not kinked, pinched or crushed behind or under the washer. Be careful when moving the washer during cleaning or maintenance. <p style="text-align: center;">Water inlet filters are clogged.</p> <ul style="list-style-type: none"> • Clean the inlet filters. See MAINTENANCE. <p style="text-align: center;">Water supply pressure to faucet or house is too low.</p> <ul style="list-style-type: none"> • Check another faucet in the house to make sure that household water pressure is adequate and flow is not restricted. • Disconnect the water inlet hoses from the washer and run a few gallons of water through the hoses to flush out any dirt. • If flow is too low, contact a plumber to have the water supply lines repaired. <p style="text-align: center;">Water supply connected with leak-limiting hoses.</p> <ul style="list-style-type: none"> • The use of hoses designed to limit leaks is not recommended. Leak-limiting hoses can trip falsely and prevent the washer from filling.



<p>OE</p> <p>WATER OUTLET ERROR</p>	<p>Drain hose is kinked, pinched, or clogged.</p> <ul style="list-style-type: none"> • Make sure that the drain hose is free of clogs or kinks and is not pinched behind or under the washer. <p>The end of the drain hose is more than 96 inches (2.4 m) above the bottom of the washer.</p> <ul style="list-style-type: none"> • Move the end of the drain hose so that it is lower than 96 inches (2.4 m)
<p>CL</p> <p>CONTROL LOCK FUNCTION</p>	<p>The control lock function is on to prevent anyone from changing cycles or operating the washer.</p> <ul style="list-style-type: none"> • Turn off the control lock function in the control panel. See Control Lock under Options and Extra Functions.
<p>dr</p> <p>DRAIN FEATURE</p>	<p>Special drain feature</p> <ul style="list-style-type: none"> • If the washer is paused during a cycle for more than 4 minutes, the cycle will be canceled and any water remaining in the tub will be drained. • This is not an error code. It indicates that the drain function is operating.
<p>dE</p> <p>LID ERROR</p>	<p>Lid is not closed properly.</p> <ul style="list-style-type: none"> • Close the lid properly. • If the lid is closed and this error message is still displayed, call for service.

 <p>LID LOCK ERROR</p>	<p>Lid is not locked properly.</p> <ul style="list-style-type: none"> • Make sure that the lid is closed properly and press the Start/ Pause button. You can hear the locking sound to lock the lid in the beginning of the cycle. The washer will not operate unless the lid is locked. • Make sure that nothing is caught under the lid, including shipping material or clothing. • Make sure that the latch mechanism is fully retracted. Make sure that the latch mechanism is fully retracted. • If the lid is closed and this error message is still displayed, call for service.
 <p>FOREIGN OBJECT ERROR</p>	<p>Foreign objects such as coins, pins, clips, etc., are caught between the pulsator and the inner tub.</p> <ul style="list-style-type: none"> • Turn the washer off then on again. Press the Spin button without selecting a cycle to drain and spin the load. • When the Spin cycle is completed, empty the tub and find and remove any objects caught in the pulsator. • Always check pockets, etc., before washing to prevent error codes or damage to the washer or clothing. • <p>For some models, LE is displayed first, then the  is displayed.</p>
 <p>TUB CLEAN ALARM</p>	<p>It is time to run the Tub Clean cycle.</p> <ul style="list-style-type: none"> • This is not an error code. It indicates that the Tub Clean cycle is running or needs to be run to clean the washer tub. • <p>For some models,  is displayed first, then the  is displayed.</p>
 <p>UNBALANCE DETECTION</p>	<p>The washer has detected an out of balance load.</p> <ul style="list-style-type: none"> • This display is for your information only, and no action is required. If the washer detects a load that is too far out of balance to spin, it will display this code while it is attempting to rebalance the load. The washer will add water and try to redistribute the load automatically.



	<ul style="list-style-type: none"> As a result, the cycle will take longer than initially estimated.
EE TEMPERATURE SENSOR ERROR	Control error <ul style="list-style-type: none"> Unplug the washer and wait 60 minutes. Reconnect power and try again. If the error code is still displayed, call for service
FE OVERFLOW ERROR	Water level is too high due to a faulty water valve. <ul style="list-style-type: none"> Close the water faucets, unplug the washer, and call for service.
PE PRESSURE SENSOR ERROR	The water level sensor is not working correctly. <ul style="list-style-type: none"> Close the water faucets, unplug the washer, and call for service.
LE MOTOR LOCKED ERROR	A motor error has occurred. <ul style="list-style-type: none"> Allow the washer to stand for 30 minutes and then restart the cycle. If the error code is still displayed, call for service.
Eb CLUTCH ERROR	Clutch error <ul style="list-style-type: none"> Mechanical failure Unplug the washer and call for service.
PS SUPPLY VOLTAGE ERROR	Supply voltage is not correct. <ul style="list-style-type: none"> Please call LG service center. You can find your local LG service center phone number on the back cover page.

Noises

Problem	Possible Cause & Solution
Clicking	<p>Lid lock sounds when the lid locks or unlocks.</p> <ul style="list-style-type: none"> • Normal operation
Spraying or hissing	<p>Water spraying or circulating during the cycle</p> <ul style="list-style-type: none"> • Normal operation
Humming or Gurgling	<p>Drain pump is pumping water from the washer at times during a cycle.</p> <ul style="list-style-type: none"> • Normal operation
Water sloshing	<p>A liquid in the balance ring around the pulsator helps the basket spin smoothly.</p> <ul style="list-style-type: none"> • Normal operation
Water being added after the washer has already begun to operate	<p>The washer adapts to the load size and type to add more water to the cycle as needed.</p> <ul style="list-style-type: none"> • Normal operation <p>The wash load may be unbalanced. If the washer senses that the load is unbalanced, it will stop and refill to redistribute the load.</p> <ul style="list-style-type: none"> • Normal operation <p>The washer may be diluting laundry additives to add to the wash load.</p> <ul style="list-style-type: none"> • Normal operation
Rattling and clanking noise	<p>Foreign objects, such as keys, coins, or safety pins may be in tub or pump.</p> <ul style="list-style-type: none"> • Stop the washer, check the tub and the drain filter for foreign objects. • If noise continues after the washer is restarted, call for service.
Thumping sound	<p>Heavy wash loads may produce a thumping sound.</p> <ul style="list-style-type: none"> • This is normal, but if the sound continues, the washer is probably out of balance. Stop and redistribute wash load.



	<p>Wash load may be out of balance.</p> <ul style="list-style-type: none"> • Pause the cycle and redistribute the load after the lid unlocks.
<p>Vibrating noise</p>	<p>Packaging materials were not removed.</p> <ul style="list-style-type: none"> • See Unpacking and Removing Shipping Material in INSTALLATION. Wash load may be unevenly distributed in the tub. <p>Wash load may be unevenly distributed in the tub.</p> <ul style="list-style-type: none"> • Pause the cycle and redistribute the load after the lid unlocks. <p>Not all leveling feet are resting firmly and evenly on the floor.</p> <ul style="list-style-type: none"> • See Leveling the Washer in INSTALLATION. <p>Floor is not rigid enough.</p> <ul style="list-style-type: none"> • Make sure that the floor is solid and does not flex. See Flooring in INSTALLATION.
<p>Squeaking noise</p>	<p>Packaging materials were not removed.</p> <ul style="list-style-type: none"> • See Unpacking and Removing shipping Material in INSTALLATION.
<p>Banging noise when the washer is filling with water.(Water hammer)</p>	<p>Plumbing in the home moves or flexes when the water valves in the washer shut off.</p> <ul style="list-style-type: none"> • Water hammer is not caused by a defect in the washer. Install water hammer arrestors (purchased separately at hardware or home improvement store) between the fill hose and the washer for best results. <p>Household water supply pressure is very high.</p> <p>Adjust household water supply regulator to a lower pressure or contact a plumber.</p>



Operation

Problem	Possible Cause & Solution
Water Leaking	<p style="text-align: center;">Hoses are not connected correctly.</p> <ul style="list-style-type: none"> • Check hoses and connectors for leaks, cracks, and splits. • Check and tighten hose connections. <p style="text-align: center;">House drain pipes are clogged.</p> <ul style="list-style-type: none"> • The washer pumps out water very rapidly. Check for water backing up out of the drain pipe during drain. If water is seen coming out of the drain, check for proper drain hose installation and check for restrictions in the drain. • Contact a plumber to repair drain pipe. <p>Drain hose has come out of the drain connector or is not inserted far enough.</p> <ul style="list-style-type: none"> • Tie drain hose to inlet hose or standpipe to prevent it from coming out during drain. • For smaller drain pipes, insert the drain hose into the pipe as far as the drain hose flange. For larger drain pipes, insert the drain hose into the pipe 1 - 2 inches past the flange. <p>A large item such as a pillow or blanket is above the top of the tub.</p> <ul style="list-style-type: none"> • Use the Bedding cycle for large or bulky items. Use extra care and never wash more than half a load of items that float, such as pillows. • Stop the washer and check the load. Make sure that the load does not crest above the top edge of the tub. <p style="text-align: center;">Oversudsing of detergent</p> <ul style="list-style-type: none"> • Oversudsing may create leaks, and may be caused by the type and amount of detergent used. HE (High-Efficiency) detergent is the only detergent recommended. The normal amount of detergent to use is 1/4 to 1/2 of the maximum amount recommended by the detergent manufacturer. • Always reduce the amount of detergent if the load is small or lightly soiled, or if the water is very soft. • Never use more than the maximum amount recommended by the detergent manufacturer
Excessive sudsing	<p style="text-align: center;">Too much detergent or incorrect detergent</p> <ul style="list-style-type: none"> • HE detergents are formulated specifically for HE (High-Efficiency) washers and contain suds reducing agents. Only use detergent with the HE (High-Efficiency) logo.



	<ul style="list-style-type: none"> For detergent quantities refer to Detergent Use in OPERATION. If sudsing or detergent residue continues to be an issue, add an extra rinse.
Washer will not turn on.	<p>Power cord is not properly plugged in.</p> <ul style="list-style-type: none"> Make sure that the plug is plugged securely into a grounded, 3-prong, 120-VAC, 60 Hz outlet. <p>House fuse is blown, circuit breaker has tripped, or power outage has occurred.</p> <ul style="list-style-type: none"> Reset circuit breaker or replace fuse. Do not increase fuse capacity. If the problem is a circuit overload, have it corrected by a qualified electrician.
Wash cycle time is longer than usual.	<p>The washer automatically adjusts the wash time for the amount of laundry, water pressure and other operating conditions.</p> <ul style="list-style-type: none"> This is normal. The washer adjusts cycle time automatically to provide optimal results for the selected cycle. The time remaining shown in the display is only an estimate. Actual time may vary
Incomplete or no dispensing of detergent	<p>Detergent compartments clogged from incorrect filling.</p> <ul style="list-style-type: none"> Make sure that detergent and additives are put into the correct dispenser compartments. For all detergent types, always make sure that the dispenser drawer is fully closed before the start of the cycle. <p>Too much detergent used.</p> <ul style="list-style-type: none"> Make sure that the suggested amount of detergent is used according to the manufacturer's recommendations. You may also dilute the detergent with water to the maximum fill line on the compartment to avoid clogging. Use only HE (High-Efficiency) detergent. - Always use as little detergent as possible. HE (High-Efficiency) washers need very little detergent to achieve optimum results. Using too much detergent will cause poor wash and rinse performance and may contribute to odors in the washer. <p>Insufficient water supply</p> <ul style="list-style-type: none"> Make sure that both hot and cold water faucets are turned on all the way.



	<p style="text-align: center;">Normal residue</p> <ul style="list-style-type: none"> • It is normal for a small amount of detergent to remain in the dispenser. If this residue builds up, it can interfere with normal dispensing of detergents. Refer to the cleaning instructions.
<p>Washer will not operate.</p>	<p style="text-align: center;">Control panel has powered off due to inactivity.</p> <ul style="list-style-type: none"> • This is normal. Press the Power button to turn on the washer. <p style="text-align: center;">Washer is unplugged.</p> <ul style="list-style-type: none"> • Make sure that the power cord is plugged securely into an electrical outlet. <p style="text-align: center;">Water supply is turned off.</p> <ul style="list-style-type: none"> • Turn both hot and cold faucets fully on. <p style="text-align: center;">Controls are not set properly.</p> <ul style="list-style-type: none"> • Make sure that the cycle was set correctly, close the lid and press the Start/Pause button to start the wash cycle. <p style="text-align: center;">Lid is open.</p> <ul style="list-style-type: none"> • Close the lid and make sure that nothing is caught under the lid preventing it from closing completely. <p style="text-align: center;">Circuit breaker/fuse is tripped/blown.</p> <ul style="list-style-type: none"> • Check house circuit breakers/fuses. Replace fuses or reset breaker. The washer should be on a dedicated branch circuit. <p style="text-align: center;">Start/Pause button was not pressed after the cycle was set.</p> <ul style="list-style-type: none"> • Press the Power button then reselect the desired cycle and press the Start/Pause button. If the Start/Pause button is not pressed within a certain time, the washer will be turned off. (The time varies by model, from 4 to 60 minutes.) <p style="text-align: center;">Extremely low water pressure.</p> <ul style="list-style-type: none"> • Check another faucet in the house to make sure that household water pressure is adequate. <p style="text-align: center;">Washer is too cold.</p> <ul style="list-style-type: none"> • If the washer has been exposed to temperatures below freezing for an extended period of time, allow it to warm up before pressing the Power button. Otherwise, the display will not come on.



<p>Washer is not filling properly.</p>	<p>Filter is clogged.</p> <ul style="list-style-type: none"> • Make sure that inlet filters on the fill valves are not clogged. Refer to Cleaning the Water Inlet Filters in MAINTENANCE. <p>Inlet hoses may be kinked.</p> <ul style="list-style-type: none"> • Check that inlet hoses are not kinked or clogged. <p>Energy efficiency</p> <ul style="list-style-type: none"> • This is a High-Efficiency (HE) washer. As a result, the water level settings for this washer may be different than for conventional washer. <p>Insufficient water supply</p> <ul style="list-style-type: none"> • Make sure that both hot and cold water faucets are turned on all the way. <p>Washer lid is open.</p> <ul style="list-style-type: none"> • Close the lid and make sure that nothing is caught under the lid preventing it from closing completely. <p>Water level is too low.</p> <ul style="list-style-type: none"> • The water will not normally cover the clothes. The fill level is optimized for the wash motion to achieve the best wash performance.
<p>Water in the washer does not drain or drains slowly.</p>	<p>Drain hose is kinked, pinched, or clogged.</p> <ul style="list-style-type: none"> • Make sure that the drain hose is free of clogs or kinks and is not pinched behind or under the washer. <p>The end of the drain hose is more than 96 inches (2.4 m) above the bottom of the washer.</p> <ul style="list-style-type: none"> • Move the end of the drain hose so that it is lower than 96 inches (2.4 m).
<p>Bleach does not dispense.</p>	<p>Bleach dispenser cover is not properly installed (on some models).</p> <ul style="list-style-type: none"> • Make sure that the bleach cover is properly installed and snapped into place before the beginning of the cycle. <p>Bleach dispenser is dirty or clogged.</p> <ul style="list-style-type: none"> • Lift out the bleach dispenser cover and clean out the reservoir. Lint and other foreign debris that are collected inside the dispenser may prevent proper dispensing of the bleach.



<p>Premature dispensing of bleach</p>	<p>Bleach dispenser filled for future load.</p> <ul style="list-style-type: none">• You cannot store bleach in the dispenser for future use. The bleach will be dispensed every load. <p>Overfilling the bleach dispenser</p> <ul style="list-style-type: none">• Overfilling the bleach dispenser will cause the bleach to dispense immediately, which will damage the laundry or the washer. Always measure bleach, but never fill above the max line on the dispenser. A half cup of bleach is sufficient for most loads. Never use more than 1 cup of bleach.
---------------------------------------	---



Performance

Problem	Possible Cause & Solution
Wrinkling	<p data-bbox="719 271 1137 304">Washer is not unloaded promptly.</p> <ul data-bbox="552 331 1378 409" style="list-style-type: none"> <li data-bbox="552 331 1378 409">• Always remove items from the washer as soon as the cycle is complete. <p data-bbox="788 439 1069 472">Washer is overloaded.</p> <ul data-bbox="552 499 1394 577" style="list-style-type: none"> <li data-bbox="552 499 1394 577">• The washer can be fully loaded, but the tub should not be tightly packed with items. The lid of the washer should close easily. <p data-bbox="655 607 1204 640">Hot and cold water inlet hoses are reversed.</p> <ul data-bbox="552 667 1406 745" style="list-style-type: none"> <li data-bbox="552 667 1406 745">• Hot water rinse can set wrinkles in garments. Check the Inlet hose connectors.
Staining	<p data-bbox="684 819 1173 853">Bleach or softener dispensed too soon.</p> <ul data-bbox="552 880 1386 1003" style="list-style-type: none"> <li data-bbox="552 880 1386 1003">• Dispenser compartment was overfilled, causing the bleach or softener to dispense immediately. Always measure bleach, and never use more than 1 cup. <p data-bbox="521 1032 1335 1066">Bleach or softener was added directly to the wash load in the tub.</p> <ul data-bbox="552 1093 1382 1171" style="list-style-type: none"> <li data-bbox="552 1093 1382 1171">• Always use the dispensers to ensure that laundry products are properly dispensed at the right time in the cycle. <p data-bbox="705 1200 1152 1234">Washer was not unloaded promptly.</p> <ul data-bbox="552 1261 1417 1339" style="list-style-type: none"> <li data-bbox="552 1261 1417 1339">• Always remove items from the washer as soon as possible after the cycle is completed. <p data-bbox="721 1368 1136 1402">Clothes were not properly sorted.</p> <ul data-bbox="552 1429 1409 1552" style="list-style-type: none"> <li data-bbox="552 1429 1409 1507">• Always wash dark colors separately from light colors and whites to prevent discoloration. <li data-bbox="552 1525 1345 1552">• Never wash heavily soiled items with lightly soiled items.
Poor stain removal	<p data-bbox="729 1632 1128 1666">Proper options are not selected.</p> <ul data-bbox="552 1693 1410 1816" style="list-style-type: none"> <li data-bbox="552 1693 1410 1816">• Heavier soils and tougher stains may require extra cleaning power. Select the Soak or Stain Care feature to boost the cleaning power of the selected cycle. <p data-bbox="796 1845 1061 1879">Previously set stains.</p> <ul data-bbox="552 1906 1394 2029" style="list-style-type: none"> <li data-bbox="552 1906 1394 2029">• Articles that have previously been washed may have stains that have been set. These stains may be difficult to remove and may require hand washing or pre-treating to aid in stain removal.



Musty or mildewy odor in the washer	<p>Incorrect or too much detergent has been used.</p> <ul style="list-style-type: none">• Use only HE (High-Efficiency) detergent in accordance with the manufacturer's instructions. <p>Inside of the tub was not cleaned properly.</p> <ul style="list-style-type: none">• Run the Tub Clean cycle regularly.
-------------------------------------	---

Warning

This content is compiled from multiple sources and is provided for reference purposes only. It may not be complete or fully applicable to all situations. If you are unable to resolve your issue, please contact the product manufacturer or an authorized service provider for official support.

